

Distributed Programming with Ice

**Michi Henning
Mark Spruiell**

With contributions by

**Dwayne Boone, Brent Eagles, Benoit Foucher,
Marc Laukien, Matthew Newhook, Bernard Normier**

Many of the designations used by manufacturers and sellers to distinguish their products are claimed as trademarks. Where those designations appear in this book and ZeroC was aware of the trademark claim, the designations have been printed in initial caps or all caps.

The authors and publisher have taken care in the preparation of this book, but make no expressed or implied warranty of any kind and assume no responsibility for errors or omissions. No liability is assumed for incidental or consequential damages in connection with or arising out of the use of the information or programs contained herein.

This work is licensed under the Creative Commons Attribution-NoDerivs 2.5 License set forth in Appendix E. To view a copy of this license, visit <http://creativecommons.org/licenses/by-nd/2.5/> or send a letter to Creative Commons, 543 Howard Street, 5th Floor, San Francisco, California, 94105, USA.

Copyright © 2003-2006 by ZeroC, Inc.
mailto:info@zeroc.com
<http://www.zeroc.com>

Revision 3.1.1r, October 2006

This revision of the documentation describes Ice version 3.1.1 with the Ruby preview release.

The Ice source distribution makes use of a number of third-party products:

- Berkeley DB, developed by Sleepycat Software (<http://www.sleepycat.com>)
- bzip2/libbzip2, developed by Julian R. Seward (<http://sources.redhat.com/bzip2>)
- The OpenSSL Toolkit, developed by the OpenSSL Project (<http://www.openssl.org>)
- SSLeay, developed by Eric Young (mailto:eay@cryptsoft.com)
- Expat, developed by James Clark (<http://www.libexpat.org>)
- STLport, developed by the STLport Standard Library Project (<http://www.stlport.org>)

See the Ice source distribution for the license agreements for each of these products.

NOTE: The documentation contains a number of unresolved cross-references to material that has not yet been written, but will be added in the future. Such cross-references are marked “XREF”.

Contents

Chapter 1	Introduction	1
1.1	Introduction	1
1.2	The Internet Communications Engine (Ice)	4
1.3	Organization of this Book	4
1.4	Typographical Conventions	5
1.5	Source Code Examples	6
1.6	Contacting the Authors	6
1.7	Ice Support	6
 Part I Ice Overview		 7
<hr/>		
Chapter 2	Ice Overview	9
2.1	Chapter Overview	9
2.2	The Ice Architecture	9
2.3	Ice Services	26
2.4	Architectural Benefits of Ice	28
2.5	A Comparison with CORBA	30
Chapter 3	A Hello World Application	35
3.1	Chapter Overview	35
3.2	Writing a Slice Definition	36
3.3	Writing an Ice Application with C++	36
3.4	Writing an Ice Application with Java	45
3.5	Writing an Ice Application with C#	52
3.6	Writing an Ice Application with Visual Basic	59
3.7	Writing an Ice Application with Python	66
3.8	Writing an Ice Application with Ruby	71
3.9	Summary	75

Part II Slice	77
Chapter 4 The Slice Language	79
4.1 Chapter Overview	79
4.2 Introduction	79
4.3 Compilation	80
4.4 Source Files	83
4.5 Lexical Rules	85
4.6 Modules	87
4.7 The Ice Module	89
4.8 Basic Slice Types	90
4.9 User-Defined Types	92
4.10 Interfaces, Operations, and Exceptions	99
4.11 Classes	124
4.12 Forward Declarations	139
4.13 Type IDs	140
4.14 Operations on Object	141
4.15 Local Types	143
4.16 Names and Scoping	144
4.17 Metadata	151
4.18 Deprecating Slice Definitions	152
4.19 Using the Slice Compilers	153
4.20 Slice Checksums	154
4.21 A Comparison of Slice and CORBA IDL	155
4.22 Generating Slice Documentation	164
4.23 Summary	170
Chapter 5 Slice for a Simple File System	171
5.1 Chapter Overview	171
5.2 The File System Application	171
5.3 Slice Definitions for the File System	172
5.4 The Complete Definition	175

Part III Language Mappings **177**

Part III.A C++ Mapping **179**

Chapter 6	Client-Side Slice-to-C++ Mapping	181
	6.1 Chapter Overview	181
	6.2 Introduction	181
	6.3 Mapping for Identifiers	182
	6.4 Mapping for Modules	183
	6.5 The Ice Namespace	184
	6.6 Mapping for Simple Built-In Types	184
	6.7 Mapping for User-Defined Types	186
	6.8 Mapping for Constants	194
	6.9 Mapping for Exceptions	195
	6.10 Mapping for Run-Time Exceptions	198
	6.11 Mapping for Interfaces	199
	6.12 Mapping for Operations	208
	6.13 Exception Handling	214
	6.14 Mapping for Classes	216
	6.15 slice2cpp Command-Line Options	239
	6.16 Using Slice Checksums	245
	6.17 A Comparison with the CORBA C++ Mapping	245
Chapter 7	Developing a File System Client in C++	247
	7.1 Chapter Overview	247
	7.2 The C++ Client	247
	7.3 Summary	252
Chapter 8	Server-Side Slice-to-C++ Mapping	255
	8.1 Chapter Overview	255
	8.2 Introduction	255
	8.3 The Server-Side main Function	256
	8.4 Mapping for Interfaces	272
	8.5 Parameter Passing	275
	8.6 Raising Exceptions	277
	8.7 Object Incarnation	278
	8.8 Summary	283
Chapter 9	Developing a File System Server in C++	285
	9.1 Chapter Overview	285
	9.2 Implementing a File System Server	285
	9.3 Summary	301

Part III.B Java Mapping	303
Chapter 10 Client-Side Slice-to-Java Mapping	305
10.1 Chapter Overview	305
10.2 Introduction	305
10.3 Mapping for Identifiers	306
10.4 Mapping for Modules	307
10.5 The <code>Ice</code> Package	308
10.6 Mapping for Simple Built-In Types	308
10.7 Mapping for User-Defined Types	308
10.8 Mapping for Constants	313
10.9 Mapping for Exceptions	314
10.10 Mapping for Run-Time Exceptions	315
10.11 Mapping for Interfaces	316
10.12 Mapping for Operations	324
10.13 Exception Handling	331
10.14 Mapping for Classes	333
10.15 Customizing the Java Mapping	341
10.16 <code>slice2java</code> Command-Line Options	354
10.17 Using Slice Checksums	354
Chapter 11 Developing a File System Client in Java	357
11.1 Chapter Overview	357
11.2 The Java Client	357
11.3 Summary	362
Chapter 12 Server-Side Slice-to-Java Mapping	363
12.1 Chapter Overview	363
12.2 Introduction	363
12.3 The Server-Side <code>main</code> Function	364
12.4 Mapping for Interfaces	369
12.5 Parameter Passing	372
12.6 Raising Exceptions	374
12.7 Tie Classes	374
12.8 Object Incarnation	378
12.9 Summary	382
Chapter 13 Developing a File System Server in Java	383
13.1 Chapter Overview	383
13.2 Implementing a File System Server	383
13.3 Summary	392

Part III.C C# Mapping	393
Chapter 14 Client-Side Slice-to-C# Mapping	395
14.1 Chapter Overview	395
14.2 Introduction	395
14.3 Mapping for Identifiers	396
14.4 Mapping for Modules	397
14.5 The <code>Ice</code> Namespace	398
14.6 Mapping for Simple Built-In Types	398
14.7 Mapping for User-Defined Types	399
14.8 Mapping for Dictionaries	411
14.9 Mapping for Constants	413
14.10 Mapping for Exceptions	415
14.11 Mapping for Interfaces	417
14.12 Mapping for Operations	425
14.13 Exception Handling	429
14.14 Mapping for Classes	431
14.15 C#-Specific Metadata Directives	440
14.16 <code>slice2cs</code> Command-Line Options	440
14.17 Using Slice Checksums	441
Chapter 15 Developing a File System Client in C#	443
15.1 Chapter Overview	443
15.2 The C# Client	443
15.3 Summary	447
Chapter 16 Server-Side Slice-to-C# Mapping	449
16.1 Chapter Overview	449
16.2 Introduction	449
16.3 The Server-Side <code>Main</code> Method	450
16.4 Mapping for Interfaces	456
16.5 Parameter Passing	459
16.6 Raising Exceptions	460
16.7 Tie Classes	461
16.8 Object Incarnation	465
16.9 Summary	469
Chapter 17 Developing a File System Server in C#	471
17.1 Chapter Overview	471
17.2 Implementing a File System Server	471
17.3 Summary	480

Part III.D Visual Basic Mapping	481
Chapter 18 Client-Side Slice-to-Visual Basic Mapping	483
18.1 Chapter Overview	483
18.2 Introduction	483
18.3 Mapping for Identifiers	484
18.4 Mapping for Modules	485
18.5 The <code>Ice</code> Namespace	486
18.6 Mapping for Simple Built-In Types	487
18.7 Mapping for User-Defined Types	487
18.8 Mapping for Dictionaries	501
18.9 Mapping for Constants	503
18.10 Mapping for Exceptions	505
18.11 Mapping for Interfaces	507
18.12 Mapping for Operations	515
18.13 Exception Handling	520
18.14 Mapping for Classes	522
18.15 VB-Specific Metadata Directives	531
18.16 <code>slice2vb</code> Command-Line Options	532
18.17 Using Slice Checksums	532
Chapter 19 Developing a File System Client in Visual Basic	535
19.1 Chapter Overview	535
19.2 The VB Client	535
19.3 Summary	539
Chapter 20 Server-Side Slice-to-Visual Basic Mapping	541
20.1 Chapter Overview	541
20.2 Introduction	541
20.3 The Server-Side <code>Main</code> Method	542
20.4 Mapping for Interfaces	548
20.5 Parameter Passing	551
20.6 Raising Exceptions	553
20.7 Tie Classes	554
20.8 Object Incarnation	557
20.9 Summary	561
Chapter 21 Developing a File System Server in Visual Basic	563
21.1 Chapter Overview	563
21.2 Implementing a File System Server	563
21.3 Summary	572

Part III.E Python Mapping	575
Chapter 22 Client-Side Slice-to-Python Mapping	577
22.1 Chapter Overview	577
22.2 Introduction	577
22.3 Mapping for Identifiers	578
22.4 Mapping for Modules	579
22.5 The <code>Ice</code> Module	579
22.6 Mapping for Simple Built-In Types	579
22.7 Mapping for User-Defined Types	580
22.8 Mapping for Constants	583
22.9 Mapping for Exceptions	584
22.10 Mapping for Run-Time Exceptions	586
22.11 Mapping for Interfaces	586
22.12 Mapping for Operations	591
22.13 Exception Handling	596
22.14 Mapping for Classes	597
22.15 Code Generation	602
22.16 Using Slice Checksums	612
Chapter 23 Developing a File System Client in Python	615
23.1 Chapter Overview	615
23.2 The Python Client	615
23.3 Summary	619
Chapter 24 Server-Side Slice-to-Python Mapping	621
24.1 Chapter Overview	621
24.2 Introduction	621
24.3 The Server-Side <code>main</code> Program	622
24.4 Mapping for Interfaces	627
24.5 Parameter Passing	630
24.6 Raising Exceptions	631
24.7 Object Incarnation	632
24.8 Summary	636
Chapter 25 Developing a File System Server in Python	637
25.1 Chapter Overview	637
25.2 Implementing a File System Server	637
25.3 Thread Safety	644
25.4 Summary	645

Part III.F Ruby Mapping	647
Chapter 26 Client-Side Slice-to-Ruby Mapping	649
26.1 Chapter Overview	649
26.2 Introduction	649
26.3 Mapping for Identifiers	650
26.4 Mapping for Modules	651
26.5 The Ice Module	651
26.6 Mapping for Simple Built-In Types	651
26.7 Mapping for User-Defined Types	652
26.8 Mapping for Constants	655
26.9 Mapping for Exceptions	656
26.10 Mapping for Run-Time Exceptions	658
26.11 Mapping for Interfaces	658
26.12 Mapping for Operations	663
26.13 Exception Handling	668
26.14 Mapping for Classes	669
26.15 Code Generation	675
26.16 Using Slice Checksums	680
Chapter 27 Developing a File System Client in Ruby	683
27.1 Chapter Overview	683
27.2 The Ruby Client	683
27.3 Summary	687
Part III.G PHP Mapping	689
Chapter 28 Ice Extension for PHP	691
28.1 Chapter Overview	691
28.2 Introduction	691
28.3 Configuration	693
28.4 Client-Side Slice-to-PHP Mapping	696
Chapter 29 Developing a File System Client in PHP	711
29.1 Chapter Overview	711
29.2 The PHP Client	711
29.3 Summary	715

Part IV Advanced Ice **717**

Chapter 30	Ice Properties and Configuration	719
30.1	Chapter Overview	719
30.2	Properties	719
30.3	Configuration Files	721
30.4	Setting Properties on the Command Line	722
30.5	The <code>Ice.Config</code> Property	723
30.6	Command-Line Parsing and Initialization	724
30.7	The <code>Ice.ProgramName</code> property	726
30.8	Using Properties Programmatically	727
30.9	Summary	736
Chapter 30	Threads and Concurrency with C++	737
30.1	Chapter Overview	737
30.2	Introduction	737
30.3	Library Overview	738
30.4	Mutexes	738
30.5	Recursive Mutexes	744
30.6	Read-Write Recursive Mutexes	747
30.7	Timed Locks	751
30.8	Monitors	755
30.9	Efficiency Considerations	764
30.10	Threads	765
30.11	Portable Signal Handling	775
30.12	Summary	776

Chapter 31	The Ice Run Time in Detail	777
31.1	Introduction	777
31.2	Communicators	778
31.3	Communicator Initialization	782
31.4	Object Adapters	783
31.5	Object Identity	794
31.6	The <code>Ice::Current</code> Object	798
31.7	Servant Locators	799
31.8	Server Implementation Techniques	815
31.9	The Ice Threading Models	847
31.10	Proxies	859
31.11	The <code>Ice::Context</code> Parameter	867
31.12	Connection Timeouts	875
31.13	Oneway Invocations	877
31.14	Datagram Invocations	882
31.15	Batched Invocations	884
31.16	Testing Proxies for Dispatch Type	886
31.17	Location Services	886
31.18	The <code>Ice::Logger</code> Interface	893
31.19	The <code>Ice::Stats</code> Interface	894
31.20	Location Transparency	895
31.21	C++ String Conversion	897
31.22	A Comparison of the Ice and CORBA Run Time	900
31.23	Summary	902
Chapter 32	Asynchronous Programming	903
32.1	Chapter Overview	903
32.2	Introduction	903
32.3	Using AMI	906
32.4	Using AMD	921
32.5	Summary	936
Chapter 33	Facets and Versioning	937
33.1	Introduction	937
33.2	Concept and APIs	937
33.3	The Versioning Problem	944
33.4	Versioning with Facets	950
33.5	Facet Selection	950
33.6	Behavioral Versioning	952
33.7	Design Considerations	954
33.8	Summary	956

Chapter 34	The Ice Protocol	957
	34.1 Chapter Overview	957
	34.2 Data Encoding	958
	34.3 Protocol Messages	982
	34.4 Compression	992
	34.5 Protocol and Encoding Versions	994
	34.6 A Comparison with IIOP	998
Chapter 35	Connection Management	1005
	35.1 Chapter Overview	1005
	35.2 Introduction	1005
	35.3 Connection Establishment	1006
	35.4 Active Connection Management	1010
	35.5 Obtaining a Connection	1012
	35.6 Connection Closure	1015
	35.7 Bidirectional Connections	1016
	35.8 Summary	1020
Chapter 36	Dynamic Ice	1021
	36.1 Chapter Overview	1021
	36.2 Streaming Interface	1021
	36.3 Dynamic Invocation and Dispatch	1060
	36.4 Asynchronous Dynamic Invocation and Dispatch	1082
	36.5 Summary	1091

Part IV Ice Services**1093**

Chapter 37	IceGrid	1095
37.1	Chapter Overview	1095
37.2	Introduction	1096
37.3	IceGrid Architecture	1098
37.4	Getting Started	1102
37.5	Well-known Objects	1113
37.6	Templates	1122
37.7	IceBox Integration	1127
37.8	Replication	1130
37.9	Load Balancing	1133
37.10	Sessions	1135
37.11	Application Distribution	1143
37.12	Dynamic Monitoring	1151
37.13	Glacier2 Integration	1154
37.14	XML Reference	1158
37.15	Variable and Parameter Semantics	1187
37.16	Property Set Semantics	1193
37.17	XML Features	1198
37.18	Server Reference	1201
37.19	Administrative Utilities	1207
37.20	Server Activation	1212
37.21	Solving Problems	1215
37.22	Summary	1218
Chapter 38	Freeze	1221
38.1	Chapter Overview	1221
38.2	Introduction	1222
38.3	The Freeze Map	1222
38.4	Using a Freeze Map in the File System Server	1236
38.5	The Freeze Evictor	1262
38.6	Using the Freeze Evictor in a File System Server	1268
38.7	Summary	1287

Chapter 39	FreezeScript	1289
	39.1 Chapter Overview	1289
	39.2 Introduction	1289
	39.3 Database Migration	1290
	39.4 Transformation Descriptors	1296
	39.5 Using transformdb	1309
	39.6 Database Inspection	1314
	39.7 Using dumpdb	1325
	39.8 Descriptor Expression Language	1328
	39.9 Summary	1332
Chapter 40	IceSSL	1333
	40.1 Chapter Overview	1333
	40.2 Introduction	1333
	40.3 Using IceSSL	1336
	40.4 Configuring IceSSL	1339
	40.5 Programming with IceSSL	1351
	40.6 Advanced Topics	1368
	40.7 Setting up a Certificate Authority	1373
	40.8 Summary	1378
Chapter 41	Glacier2	1379
	41.1 Chapter Overview	1379
	41.2 Introduction	1379
	41.3 Using Glacier2	1384
	41.4 Callbacks	1390
	41.5 Router Security	1393
	41.6 Session Management	1400
	41.7 Dynamic Filtering	1403
	41.8 Request Buffering	1405
	41.9 Request Contexts	1407
	41.10 Firewalls	1409
	41.11 Advanced Client Configurations	1410
	41.12 IceGrid Integration	1411
	41.13 Summary	1413
Chapter 42	IceBox	1415
	42.1 Chapter Overview	1415
	42.2 Introduction	1415
	42.3 The Service Manager	1416
	42.4 Developing a Service	1418
	42.5 Starting IceBox	1426
	42.6 Summary	1427

Chapter 43	IceStorm	1429
43.1	Chapter Overview	1429
43.2	Introduction	1429
43.3	Concepts	1431
43.4	IceStorm Interface Overview	1434
43.5	Using IceStorm	1436
43.6	IceStorm Administration	1446
43.7	Topic Federation	1447
43.8	Quality of Service	1455
43.9	Configuring IceStorm	1457
43.10	Summary	1459
Chapter 44	IcePatch2	1461
44.1	Chapter Overview	1461
44.2	Introduction	1461
44.3	Using <code>icepatch2calc</code>	1462
44.4	Running the Server	1465
44.5	Running the Client	1466
44.6	Object Identities	1469
44.7	Creating a Custom Client	1469
44.8	Summary	1470
Appendixes		1471
Appendix A	Slice Keywords	1473

Appendix B	Slice Documentation	1475
B.1	Ice	1475
B.2	Ice::AdapterAlreadyActiveException	1479
B.3	Ice::AdapterNotFoundException	1480
B.4	Ice::AlreadyRegisteredException	1480
B.5	Ice::BadMagicException	1481
B.6	Ice::CloneNotImplementedException	1481
B.7	Ice::CloseConnectionException	1481
B.8	Ice::CloseTimeoutException	1482
B.9	Ice::CollocationOptimizationException	1482
B.10	Ice::Communicator	1482
B.11	Ice::CommunicatorDestroyedException	1492
B.12	Ice::CompressionException	1493
B.13	Ice::ConnectFailedException	1493
B.14	Ice::ConnectTimeoutException	1493
B.15	Ice::Connection	1494
B.16	Ice::ConnectionLostException	1497
B.17	Ice::ConnectionNotValidatedException	1497
B.18	Ice::ConnectionRefusedException	1497
B.19	Ice::ConnectionTimeoutException	1497
B.20	Ice::Current	1498
B.21	Ice::DNSException	1499
B.22	Ice::DatagramLimitException	1500
B.23	Ice::EncapsulationException	1500
B.24	Ice::Endpoint	1501
B.25	Ice::EndpointParseException	1501
B.26	Ice::EndpointSelectionType	1502
B.27	Ice::FacetNotExistException	1502
B.28	Ice::FeatureNotSupportedException	1503
B.29	Ice::FileException	1503
B.30	Ice::ForcedCloseConnectionException	1503
B.31	Ice::Identity	1504
B.32	Ice::IdentityParseException	1505
B.33	Ice::IllegalIdentityException	1505
B.34	Ice::IllegalIndirectionException	1506
B.35	Ice::IllegalMessageSizeException	1506
B.36	Ice::InitializationException	1506
B.37	Ice::InvalidReplicaGroupIdException	1507
B.38	Ice::Locator	1507
B.39	Ice::LocatorRegistry	1509
B.40	Ice::Logger	1511
B.41	Ice::MarshalException	1513

B.42	Ice::MemoryLimitException	1513
B.43	Ice::NegativeSizeException	1513
B.44	Ice::NoEndpointException	1514
B.45	Ice::NoObjectFactoryException	1514
B.46	Ice::NotRegisteredException	1515
B.47	Ice::ObjectAdapter	1515
B.48	Ice::ObjectAdapterDeactivatedException	1527
B.49	Ice::ObjectAdapterIdInUseException	1528
B.50	Ice::ObjectFactory	1528
B.51	Ice::ObjectNotExistException	1530
B.52	Ice::ObjectNotFoundException	1530
B.53	Ice::OperationMode	1530
B.54	Ice::OperationNotExistException	1531
B.55	Ice::Plugin	1532
B.56	Ice::PluginInitializationException	1532
B.57	Ice::PluginManager	1533
B.58	Ice::Process	1535
B.59	Ice::Properties	1536
B.60	Ice::ProtocolException	1540
B.61	Ice::ProxyParseException	1541
B.62	Ice::ProxyUnmarshalException	1541
B.63	Ice::RequestFailedException	1542
B.64	Ice::Router	1542
B.65	Ice::SecurityException	1544
B.66	Ice::ServantLocator	1545
B.67	Ice::ServerNotFoundException	1547
B.68	Ice::SocketException	1547
B.69	Ice::Stats	1547
B.70	Ice::StringConversionException	1549
B.71	Ice::SyscallException	1549
B.72	Ice::TimeoutException	1549
B.73	Ice::TwayOnlyException	1550
B.74	Ice::UnknownException	1550
B.75	Ice::UnknownLocalException	1551
B.76	Ice::UnknownMessageException	1551
B.77	Ice::UnknownReplyStatusException	1552
B.78	Ice::UnknownRequestIdException	1552
B.79	Ice::UnknownUserException	1552
B.80	Ice::UnmarshalOutOfBoundsException	1553
B.81	Ice::UnsupportedEncodingException	1553
B.82	Ice::UnsupportedProtocolException	1554
B.83	Ice::VersionMismatchException	1555

B.84	Freeze	1555
B.85	Freeze::CatalogData	1555
B.86	Freeze::Connection	1556
B.87	Freeze::DatabaseException	1557
B.88	Freeze::DeadlockException	1558
B.89	Freeze::Evictor	1558
B.90	Freeze::EvictorDeactivatedException	1568
B.91	Freeze::EvictorIterator	1568
B.92	Freeze::InvalidPositionException	1569
B.93	Freeze::NoSuchElementException	1570
B.94	Freeze::NotFoundException	1570
B.95	Freeze::ObjectRecord	1570
B.96	Freeze::ServantInitializer	1571
B.97	Freeze::Statistics	1572
B.98	Freeze::Transaction	1572
B.99	Freeze::TransactionAlreadyInProgressException	1573
B.100	IceBox	1573
B.101	IceBox::FailureException	1574
B.102	IceBox::Service	1574
B.103	IceBox::ServiceManager	1575
B.104	Glacier2	1576
B.105	Glacier2::Admin	1576
B.106	Glacier2::CannotCreateSessionException	1577
B.107	Glacier2::IdentitySet	1577
B.108	Glacier2::PermissionDeniedException	1578
B.109	Glacier2::PermissionsVerifier	1579
B.110	Glacier2::Router	1580
B.111	Glacier2::SSLInfo	1582
B.112	Glacier2::SSLPermissionsVerifier	1584
B.113	Glacier2::SSLSessionManager	1585
B.114	Glacier2::Session	1586
B.115	Glacier2::SessionControl	1586
B.116	Glacier2::SessionManager	1587
B.117	Glacier2::SessionNotExistException	1588
B.118	Glacier2::StringSet	1589
B.119	IceGrid	1590
B.120	IceGrid::AccessDeniedException	1596
B.121	IceGrid::AdapterDescriptor	1596
B.122	IceGrid::AdapterDynamicInfo	1598
B.123	IceGrid::AdapterInfo	1598
B.124	IceGrid::AdapterNotExistException	1599
B.125	IceGrid::AdaptiveLoadBalancingPolicy	1599

B.126	IceGrid::Admin	1600
B.127	IceGrid::AdminSession	1619
B.128	IceGrid::AllocationException	1621
B.129	IceGrid::AllocationTimeoutException	1622
B.130	IceGrid::ApplicationDescriptor	1622
B.131	IceGrid::ApplicationNotExistException	1624
B.132	IceGrid::ApplicationUpdateDescriptor	1624
B.133	IceGrid::BadSignalException	1627
B.134	IceGrid::BoxedDistributionDescriptor	1627
B.135	IceGrid::BoxedString	1628
B.136	IceGrid::CommunicatorDescriptor	1628
B.137	IceGrid::DbEnvDescriptor	1629
B.138	IceGrid::DeploymentException	1630
B.139	IceGrid::DistributionDescriptor	1631
B.140	IceGrid::FileParser	1631
B.141	IceGrid::IceBoxDescriptor	1632
B.142	IceGrid::LoadBalancingPolicy	1633
B.143	IceGrid::LoadInfo	1633
B.144	IceGrid::LoadSample	1634
B.145	IceGrid::NodeDescriptor	1635
B.146	IceGrid::NodeDynamicInfo	1636
B.147	IceGrid::NodeInfo	1637
B.148	IceGrid::NodeNotExistException	1638
B.149	IceGrid::NodeObserver	1638
B.150	IceGrid::NodeUnreachableException	1640
B.151	IceGrid::NodeUpdateDescriptor	1641
B.152	IceGrid::ObjectDescriptor	1643
B.153	IceGrid::ObjectExistsException	1643
B.154	IceGrid::ObjectInfo	1644
B.155	IceGrid::ObjectNotRegisteredException	1644
B.156	IceGrid::ParseException	1645
B.157	IceGrid::PatchException	1645
B.158	IceGrid::PermissionDeniedException	1646
B.159	IceGrid::PropertyDescriptor	1647
B.160	IceGrid::PropertySetDescriptor	1647
B.161	IceGrid::Query	1648
B.162	IceGrid::RandomLoadBalancingPolicy	1650
B.163	IceGrid::Registry	1650
B.164	IceGrid::RegistryObserver	1653
B.165	IceGrid::ReplicaGroupDescriptor	1656
B.166	IceGrid::RoundRobinLoadBalancingPolicy	1657
B.167	IceGrid::ServerDescriptor	1657

B.168	IceGrid::ServerDynamicInfo	1660
B.169	IceGrid::ServerInfo	1661
B.170	IceGrid::ServerInstanceDescriptor	1661
B.171	IceGrid::ServerNotExistException	1662
B.172	IceGrid::ServerStartException	1663
B.173	IceGrid::ServerState	1663
B.174	IceGrid::ServerStopException	1665
B.175	IceGrid::ServiceDescriptor	1665
B.176	IceGrid::ServiceInstanceDescriptor	1666
B.177	IceGrid::Session	1667
B.178	IceGrid::TemplateDescriptor	1670
B.179	IceGrid::UserAccountMapper	1670
B.180	IceGrid::UserAccountNotFoundException	1671
B.181	IceStorm	1672
B.182	IceStorm::LinkExists	1673
B.183	IceStorm::LinkInfo	1673
B.184	IceStorm::NoSuchLink	1674
B.185	IceStorm::NoSuchTopic	1674
B.186	IceStorm::Topic	1675
B.187	IceStorm::TopicExists	1678
B.188	IceStorm::TopicManager	1678
B.189	IcePatch2	1680
B.190	IcePatch2::Admin	1681
B.191	IcePatch2::FileAccessException	1681
B.192	IcePatch2::FileInfo	1682
B.193	IcePatch2::FileServer	1683
B.194	IcePatch2::PartitionOutOfRangeException	1684

Appendix C	Properties	1687
	C.1 Ice Configuration Property	1687
	C.2 Ice Trace Properties	1688
	C.3 Ice Warning Properties	1691
	C.4 Ice Object Adapter Properties	1693
	C.5 Ice Plugin Properties	1698
	C.6 Ice Thread Pool Properties	1699
	C.7 Ice Default and Override Properties	1701
	C.8 Ice Miscellaneous Properties	1704
	C.9 IceSSL Properties	1713
	C.10 IceBox Properties	1728
	C.11 IceStorm Properties	1753
	C.12 Glacier2 Properties	1760
	C.13 Freeze Properties	1772
	C.14 IcePatch2 Properties	1778
Appendix D	Proxies and Endpoints	1781
	D.1 Proxies	1781
	D.2 Endpoints	1783
Appendix E	License Information	1793
	E.1 Definitions	1793
	E.2 Fair Use Rights	1794
	E.3 License Grant	1794
	E.4 Restrictions	1795
	E.5 Representations, Warranties and Disclaimer	1796
	E.6 Limitation on Liability	1797
	E.7 Termination	1797
	E.8 Miscellaneous	1797
Bibliography		1799

Chapter 1

Introduction

1.1 Introduction

Since the mid-nineties, the computing industry has been using object-oriented middleware platforms, such as DCOM [3] and CORBA [4]. Object-oriented middleware was an important step forward toward making distributed computing available to application developers. For the first time, it was possible to build distributed applications without having to be a networking guru: the middleware platform took care of the majority of networking chores, such as *marshaling* and *unmarshaling* (encoding and decoding data for transmission), mapping logical object addresses to physical transport endpoints, changing the representation of data according to the native machine architecture of client and server, and automatically starting servers on demand.

Yet, neither DCOM nor CORBA succeeded in capturing a majority of the distributed computing market, for a number of reasons:

- DCOM was a Microsoft-only solution that could not be used in heterogeneous networks containing machines running a variety of operating systems.
- DCOM was impossible to scale to large numbers (hundreds of thousands or millions) of objects, largely due to the overhead of its distributed garbage collection mechanism.
- Although available from a variety of vendors, it was rarely possible to find a single vendor that could provide an implementation for all of the environ-

ments in a heterogeneous network. Despite much standardization effort, lack of interoperability between different CORBA implementations continued to cause problems, and source code compatibility for languages such as C or C++ was never fully achieved, usually due to vendor-specific extensions and CORBA's lack of a specification for multi-threaded environments.

- Both DCOM and CORBA suffered from excessive complexity. Becoming proficient and designing for and programming with either platform was a formidable task that took many months (or, to reach expert level, many years) to master.
- Performance issues have plagued both platforms through their respective histories. For DCOM, only one implementation was available, so shopping around for a better-performing implementation was not an option. While CORBA was available from a number of vendors, it was difficult (if not impossible) to find standards-compliant implementations that performed well, mainly due to the complexity imposed by the CORBA specification itself (which, in many cases, was feature-rich beyond need).
- In heterogeneous environments, the coexistence of DCOM and CORBA was never an easy one either: while some vendors offered interoperability products, interoperability between the two platforms was never seamless and difficult to administer, resulting in disconnected islands of different technologies.

DCOM was superseded by the Microsoft .NET platform [11] in 2002. While .NET offers more powerful distributed computing support than DCOM, it is still a Microsoft-only solution and therefore not an option for heterogeneous environments. On the other hand, CORBA has been stagnating in recent history and a number of vendors have left the market, leaving the customer with a platform that is no longer widely supported; the interest of the few remaining vendors in further standardization has waned, with the result that many defects in the CORBA specifications are not addressed, or addressed only years after they are first reported.

Simultaneously with the decline of DCOM and CORBA, a lot of interest arose in the distributed computing community around SOAP [26] and web services [27]. The idea of using the ubiquitous World Wide Web infrastructure and HTTP to develop a middleware platform was intriguing—at least in theory, SOAP and web services had the promise of becoming the lingua franca of distributed computing on the Internet. Despite much publicity and many published papers, web services have failed to deliver on that promise: as of this writing, very few commercial systems that use the web services architecture have been developed. There are a number of reasons for this:

- SOAP imposes very serious performance penalties on applications, both in terms of network bandwidth and CPU overhead, to the extent that the technology is unsuitable for many performance-critical systems.
- While SOAP provides an “on-the-wire” specification, this is insufficient for the development of realistic applications because the abstraction levels provided by the specifications are too low. While an application can cobble SOAP messages together, doing so is tedious and error-prone in the extreme.
- The lack of higher-level abstractions prompted a number of vendors to provide application development platforms that automate the development of SOAP-compliant applications. However, these development platforms, lacking any standardization beyond the protocol level, are by necessity proprietary, so applications developed with tools from one vendor cannot be used with middleware products from other vendors.
- There are serious concerns [15] about the architectural soundness of SOAP and web services. In particular, many experts have expressed concerns about the inherent lack of security of the platform.
- Web services is a technology in its infancy. Little standardization has taken place so far [27], and it appears that it will be years before standardization reaches the level of completeness that is necessary for source code compatibility and cross-vendor interoperability.

As a result, developers who are looking for a middleware platform are faced with a number of equally unpleasant options:

- Choose .NET
The most serious drawback is that non-Microsoft platforms are not supported.
- Choose CORBA
The most serious drawbacks are the high degree of complexity of an aging platform, coupled with ongoing vendor attrition.
- Choose Web Services
The most serious drawbacks are the severe inefficiencies and the need to use proprietary development platforms, as well as security issues.

These options look very much like a no-win scenario: you can either choose a platform that won't run on anything but Microsoft architectures, or you can choose a platform that is complex and suffering from gradual abandonment, or you can choose a platform that is inefficient and, due to the lack of standardization, proprietary.

1.2 The Internet Communications Engine (Ice)

It is against this unpleasant background of choices that ZeroC, Inc. decided to develop the Internet Communications Engine, or Ice for short.¹ The main design goals of Ice are:

- Provide an object-oriented middleware platform suitable for use in heterogeneous environments.
- Provide a full set of features that support development of realistic distributed applications for a wide variety of domains.
- Avoid unnecessary complexity, making the platform easy to learn and to use.
- Provide an implementation that is efficient in network bandwidth, memory use, and CPU overhead.
- Provide an implementation that has built-in security, making it suitable for use over insecure public networks.

To be more simplistic, the Ice design goals could be stated as “Let’s build a middleware platform that is as powerful as CORBA, without making all of CORBA’s mistakes.”

1.3 Organization of this Book

This book is divided into four parts and a number of appendixes:

- “Part I: Ice Overview” provides an overview of the features offered by Ice and explains the Ice object model. After reading this part, you will understand the major features and architecture of the Ice platform, its object model and request dispatch model, and know the basic steps required to build a simple application in C++, Java, C#, Visual Basic, and Python.
- “Part II: Slice” explains the Slice definition language. After reading this part, you will have detailed knowledge of how to specify interfaces and types for a distributed application.
- “Part III: Language Mappings” contains a sub-part for each of the language mappings. After reading the relevant sub-part, you will know how to implement an application in your language of choice.

1. The acronym “Ice” is pronounced as a single syllable, like the word for frozen water.

- “Part IV: Advanced Ice” presents many Ice features in detail and covers advanced aspects of server development, such as properties, threading, object life cycle, object location, persistence, and asynchronous as well as dynamic method invocation and dispatch. After reading this part, you will understand the advanced features of Ice and how to effectively use them to find the correct trade-off between performance and resource consumption as appropriate for your application requirements.
- “Part IV: Ice Services” covers the services provided with Ice, such as IceGrid (a sophisticated deployment tool), Glacier2 (the Ice firewall solution), IceStorm (the Ice messaging service), and IcePatch2 (a software patching service).²
- The Appendixes contain the Ice reference material.

NOTE: This entire manual is also available online as a set of HTML pages. You can find the latest version of the manual at <http://www.zeroc.com/Ice-Manual.html>.

1.4 Typographical Conventions

This book uses the following typographical conventions:

- Slice source code appears in `Lucida Sans Typewriter`.
- Programming-language source code appears in `Courier`.
- File names appear in `Courier`.
- Commands appear in **Courier Bold**.

Occasionally, we present copy of an interactive session at a terminal. In such cases, we assume a Bourne shell (or one of its derivatives, such as `ksh` or `bash`). Output presented by the system is shown in `Courier`, and input is presented in **Courier Bold**, for example:

```
$ echo hello
hello
```

2. If you notice a certain commonality in the theme of naming Ice features, it just goes to show that software developers are still inveterate punsters.

Slice and the various programming languages often use the same identifiers. When we talk about an identifier in its generic, language-independent sense, we use `Lucida Sans Typewriter`. When we talk about an identifier in its language-specific (for example, C++ or Java) sense, we use `Courier`.

1.5 Source Code Examples

Throughout the book, we use a case study to illustrate various aspects of Ice. The case study implements a simple distributed hierarchical file system, which we progressively improve to take advantage of more sophisticated features as the book progresses. The source code for the case study in its various stages is provided with the distribution of this book. We encourage you to experiment with these code examples (as well as the many demonstration programs that ship with Ice).

1.6 Contacting the Authors

We would very much like to hear from you in case you find any bugs (however minor) in this book. We also would like to hear your opinion on the contents, and any suggestions as to how it might be improved. You can contact us via e-mail at <mailto:icebook@zeroc.com>.

1.7 Ice Support

ZeroC maintains a discussion and support forum at <http://www.zeroc.com/support.html>. You can use this forum for any questions or suggestions you may have about the Ice platform, as well as to get support for specific problems you encounter.

Part I

Ice Overview

Chapter 2

Ice Overview

2.1 Chapter Overview

In this chapter, we present a high-level overview of the Ice architecture. Section 2.2 introduces fundamental concepts and terminology, and outlines how Slice definitions, language mappings, and the Ice run time and protocol work in concert to create clients and servers. Section 2.3 briefly presents the object services provided by Ice, and Section 2.4 outlines the benefits that result from the Ice architecture. Finally, Section 2.5 presents a brief comparison of the Ice and CORBA architectures.

2.2 The Ice Architecture

2.2.1 Introduction

Ice is an object-oriented middleware platform. Fundamentally, this means that Ice provides tools, APIs, and library support for building object-oriented client–server applications. Ice applications are suitable for use in heterogeneous environments: client and server can be written in different programming languages, can run on different operating systems and machine architectures, and can communicate

using a variety of networking technologies. The source code for these applications is portable regardless of the deployment environment.

2.2.2 Terminology

Every computing technology creates its own vocabulary as it evolves. Ice is no exception. However, the amount of new jargon used by Ice is minimal. Rather than inventing new terms, we have used existing terminology as much as possible. If you have used another middleware technology, such as CORBA, in the past, you will be familiar with most of what follows. (However, we suggest you at least skim the material because a few terms used by Ice *do* differ from the corresponding CORBA terminology.)

Clients and Servers

The terms *client* and *server* are not firm designations for particular parts of an application; rather, they denote roles that are taken by parts of an application for the duration of a request:

- Clients are active entities. They issue requests for service to servers.
- Servers are passive entities. They provide services in response to client requests.

Frequently, servers are not “pure” servers, in the sense that they never issue requests and only respond to requests. Instead, servers often act as a server on behalf of some client but, in turn, act as a client to another server in order to satisfy their client’s request.

Similarly, clients often are not “pure” clients, in the sense that they only request service from an object. Instead, clients are frequently client–server hybrids. For example, a client might start a long-running operation on a server; as part of starting the operation, the client can provide a *callback object* to the server that is used by the server to notify the client when the operation is complete. In that case, the client acts as a client when it starts the operation, and as a server when it is notified that the operation is complete.

Such role reversal is common in many systems, so, frequently, client–server systems could be more accurately described as *peer-to-peer* systems.

Ice Objects

An *Ice object* is a conceptual entity, or abstraction. An Ice object can be characterized by the following points:

- An Ice object is an entity in the local or a remote address space that can respond to client requests.
- A single Ice object can be instantiated in a single server or, redundantly, in multiple servers. If an object has multiple simultaneous instantiations, it is still a single Ice object.
- Each Ice object has one or more *interfaces*. An interface is a collection of named *operations* that are supported by an object. Clients issue requests by invoking operations.
- An operation has zero or more *parameters* as well as a *return value*. Parameters and return values have a specific *type*. Parameters are named and have a direction: in-parameters are initialized by the client and passed to the server; out-parameters are initialized by the server and passed to the client. (The return value is simply a special out-parameter.)
- An Ice object has a distinguished interface, known as its *main interface*. In addition, an Ice object can provide zero or more alternate interfaces, known as *facets*. Clients can select among the facets of an object to choose the interface they want to work with.
- Each Ice object has a unique *object identity*. An object's identity is an identifying value that distinguishes the object from all other objects. The Ice object model assumes that object identities are globally unique, that is, no two objects within an Ice communication domain can have the same object identity.

In practice, you need not use object identities that are globally unique, such as UUIDs [14], only identities that do not clash with any other identity within your domain of interest. However, there are architectural advantages to using globally unique identifiers, which we explore in XREF.

Proxies

For a client to be able to contact an Ice object, the client must hold a *proxy* for the Ice object.¹ A proxy is an artifact that is local to the client's address space; it represents the (possibly remote) Ice object for the client. A proxy acts as the local

1. A proxy is the equivalent of a CORBA object reference. We use "proxy" instead of "reference" to avoid confusion: "reference" already has too many other meanings in various programming languages.

ambassador for an Ice object: when the client invokes an operation on the proxy, the Ice run time:

1. Locates the Ice object
2. Activates the Ice object's server if it is not running
3. Activates the Ice object within the server
4. Transmits any in-parameters to the Ice object
5. Waits for the operation to complete
6. Returns any out-parameters and the return value to the client (or throws an exception in case of an error)

A proxy encapsulates all the necessary information for this sequence of steps to take place. In particular, a proxy contains:

- Addressing information that allows the client-side run time to contact the correct server
- An object identity that identifies which particular object in the server is the target of a request
- An optional facet identifier that determines which particular facet of an object the proxy refers to

Section 31.10 provides more information about proxies.

Stringified Proxies

The information in a proxy can be expressed as a string. For example, the string

```
SimplePrinter:default -p 10000
```

is a human-readable representation of a proxy. The Ice run time provides API calls that allow you to convert a proxy to its stringified form and vice versa. This is useful, for example, to store proxies in database tables or text files.

Provided that a client knows the identity of an Ice object and its addressing information, it can create a proxy “out of thin air” by supplying that information. In other words, no part of the information inside a proxy is considered opaque; a client needs to know only an object's identity, addressing information, and (to be able to invoke an operation) the object's type in order to contact the object.

Direct Proxies

A *direct proxy* is a proxy that embeds an object's identity, together with the *address* at which its server runs. The address is completely specified by:

- a protocol identifier (such TCP/IP or UDP)

- a protocol-specific address (such as a host name and port number)

To contact the object denoted by a direct proxy, the Ice run time uses the addressing information in the proxy to contact the server; the identity of the object is sent to the server with each request made by the client.

Indirect Proxies

An *indirect proxy* has two forms. It may provide only an object's identity, or it may specify an identity together with an *object adapter identifier*. An object that is accessible using only its identity is called a *well-known object*. For example, the string

```
SimplePrinter
```

is a valid proxy for a well-known object with the identity `SimplePrinter`.

An indirect proxy that includes an object adapter identifier has the stringified form

```
SimplePrinter@PrinterAdapter
```

Any object of the object adapter can be accessed using such a proxy, regardless of whether that object is also a well-known object.

Notice that an indirect proxy contains no addressing information. To determine the correct server, the client-side run time passes the proxy information to a location service (see Section 31.17). In turn, the location service uses the object identity or the object adapter identifier as the key in a lookup table that contains the address of the server and returns the current server address to the client. The client-side run time now knows how to contact the server and dispatches the client request as usual.

The entire process is similar to the mapping from Internet domain names to IP address by the Domain Name Service (DNS): when we use a domain name, such as `www.zeroc.com`, to look up a web page, the host name is first resolved to an IP address behind the scenes and, once the correct IP address is known, the IP address is used to connect to the server. With Ice, the mapping is from an object identity or object adapter identifier to a protocol-address pair, but otherwise very similar. The client-side run time knows how to contact the location service via configuration (just as web browsers know which DNS to use via configuration).

Direct Versus Indirect Binding

The process of resolving the information in a proxy to protocol-address pair is known as *binding*. Not surprisingly, *direct binding* is used for direct proxies, and *indirect binding* is used for indirect proxies.

The main advantage of indirect binding is that it allows us to move servers around (that is, change their address) without invalidating existing proxies that are held by clients. In other words, direct proxies avoid the extra lookup to locate the server but no longer work if a server is moved to a different machine. On the other hand, indirect proxies continue to work even if we move (or *migrate*) a server.

Fixed Proxies

A *fixed proxy* is a proxy that is bound to a particular connection: instead of containing addressing information or an adapter name, the proxy contains a connection handle. The connection handle stays valid only for as long as the connection stays open so, once the connection is closed, the proxy no longer works (and will never work again). Fixed proxies cannot be marshaled, that is, they cannot be passed as parameters on operation invocations. Fixed proxies are used to allow bidirectional communication, so a server can make callbacks to a client without having to open a new connection (see Section 35.7).

Replication

In Ice, *replication* involves making object adapters (and their objects) available at multiple addresses. The goal of replication is usually to provide redundancy by running the same server on several computers. If one of the computers should happen to fail, a server still remains available on the others.

The use of replication implies that applications are designed for it. In particular, it means a client can access an object via one address and obtain the same result as from any other address. Either these objects are stateless, or their implementations are designed to synchronize with a database (or each other) in order to maintain a consistent view of each object's state.

Ice supports a limited form of replication when a proxy specifies multiple addresses for an object. The Ice run time selects one of the addresses at random for its initial connection attempt (see Section 31.10) and tries all of them in the case of a failure. For example, consider this proxy:

```
SimplePrinter:tcp -h server1 -p 10001:tcp -h server2 -p 10002
```

The proxy states that the object with identity `SimplePrinter` is available using TCP at two addresses, one on the host `server1` and another on the host `server2`. The burden falls to users or system administrators to ensure that the servers are actually running on these computers at the specified ports.

Replica Groups

In addition to the proxy-based replication described above, Ice supports a more useful form of replication known as *replica groups* that requires the use of a location service (see Section 31.17).

A replica group has a unique identifier and consists of any number of object adapters. An object adapter may be a member of at most one replica group; such an adapter is considered to be a *replicated object adapter*.

After a replica group has been established, its identifier can be used in an indirect proxy in place of an adapter identifier. For example, a replica group identified as `PrinterAdapters` can be used in a proxy as shown below:

```
SimplePrinter@PrinterAdapters
```

The replica group is treated by the location service as a “virtual object adapter.” The behavior of the location service when resolving an indirect proxy containing a replica group id is an implementation detail. For example, the location service could decide to return the addresses of all object adapters in the group, in which case the client’s Ice run time would select one of the addresses at random using the limited form of replication discussed earlier. Another possibility is for the location service to return only one address, which it decided upon using some heuristic.

Regardless of the way in which a location service resolves a replica group, the key benefit is indirection: the location service as a middleman can add more intelligence to the binding process.

Servants

As we mentioned on page 10, an Ice object is a conceptual entity that has a type, identity, and addressing information. However, client requests ultimately must end up with a concrete server-side processing entity that can provide the behavior for an operation invocation. To put this differently, a client request must ultimately end up executing code inside the server, with that code written in a specific programming language and executing on a specific processor.

The server-side artifact that provides behavior for operation invocations is known as a *servant*. A servant provides substance for (or *incarnates*) one or more Ice objects. In practice, a servant is simply an instance of a class that is written by the server developer and that is registered with the server-side run time as the servant for one or more Ice objects. Methods on the class correspond to the operations on the Ice object’s interface and provide the behavior for the operations.

A single servant can incarnate a single Ice object at a time or several Ice objects simultaneously. If the former, the identity of the Ice object incarnated by the servant is implicit in the servant. If the latter, the servant is provided the identity of the Ice object with each request, so it can decide which object to incarnate for the duration of the request.

Conversely, a single Ice object can have multiple servants. For example, we might choose to create a proxy for an Ice object with two different addresses for different machines. In that case, we will have two servers, with each server containing a servant for the same Ice object. When a client invokes an operation on such an Ice object, the client-side run time sends the request to exactly one server. In other words, multiple servants for a single Ice object allow you to build redundant systems: the client-side run time attempts to send the request to one server and, if that attempt fails, sends the request to the second server. Only if the second attempt fails is an error reported back to the client-side application code.

At-Most-Once Semantics

Ice requests have *at-most-once* semantics: the Ice run time does its best to deliver a request to the correct destination and, depending on the exact circumstances, may retry a failed request. Ice guarantees that it will either deliver the request, or, if it cannot deliver the request, inform the client with an appropriate exception; under no circumstances is a request delivered twice, that is, retries are attempted only if it is known that a previous attempt definitely failed.²

At-most-once semantics are important because they guarantee that operations that are not *idempotent* can be used safely. An idempotent operation is an operation that, if executed twice, has the same effect as if executed once. For example, `x = 1 ;` is an idempotent operation: if we execute the operation twice, the end result is the same as if we had executed it once. On the other hand, `x++ ;` is not idempotent: if we execute the operation twice, the end result is not the same as if we had executed it once.

Without at-most-once semantics, we can build distributed systems that are more robust in the presence of network failures. However, realistic systems require non-idempotent operations, so at-most-once semantics are a necessity, even though they make the system less robust in the presence of network failures. Ice permits you to mark individual operations as idempotent. For such operations,

2. One exception to this rule are datagram invocations over UDP transports. For these, duplicated UDP packets can lead to a violation of at-most-once semantics.

the Ice run time uses a more aggressive error recovery mechanism than for non-idempotent operations.

Synchronous Method Invocation

By default, the request dispatch model used by Ice is a synchronous remote procedure call: an operation invocation behaves like a local procedure call, that is, the client thread is suspended for the duration of the call and resumes when the call completes (and all its results are available).

Asynchronous Method Invocation

Ice also supports *asynchronous method invocation (AMI)*: clients can invoke operations *asynchronously*, that is, the client uses a proxy as usual to invoke an operation but, in addition to passing the normal parameters, also passes a *callback object* and the client invocation returns immediately. Once the operation completes, the client-side run time invokes a method on the callback object passed initially, passing the results of the operation to the callback object (or, in case of failure, passing exception information).

The server cannot distinguish an asynchronous invocation from a synchronous one—either way, the server simply sees that a client has invoked an operation on an object.

Asynchronous Method Dispatch

Asynchronous method dispatch (AMD) is the server-side equivalent of AMI. For synchronous dispatch (the default), the server-side run time up-calls into the application code in the server in response to an operation invocation. While the operation is executing (or sleeping, for example, because it is waiting for data), a thread of execution is tied up in the server; that thread is released only when the operation completes.

With asynchronous method dispatch, the server-side application code is informed of the arrival of an operation invocation. However, instead of being forced to process the request immediately, the server-side application can choose to delay processing of the request and, in doing so, releases the execution thread for the request. The server-side application code is now free to do whatever it likes. Eventually, once the results of the operation are available, the server-side application code makes an API call to inform the server-side Ice run time that a request that was dispatched previously is now complete; at that point, the results of the operation are returned to the client.

Asynchronous method dispatch is useful if, for example, a server offers operations that block clients for an extended period of time. For example, the server may have an object with a `get` operation that returns data from an external, asynchronous data source and that blocks clients until the data becomes available. With synchronous dispatch, each client waiting for data to arrive ties up an execution thread in the server. Clearly, this approach does not scale beyond a few dozen clients. With asynchronous dispatch, hundreds or thousands of clients can be blocked in the same operation invocation without tying up any threads in the server.

Another way to use asynchronous method dispatch is to complete an operation, so the results of the operation are returned to the client, but to keep the execution thread of the operation beyond the duration of the operation invocation. This allows you to continue processing after results have been returned to the client, for example, to perform cleanup or write updates to persistent storage.

Synchronous and asynchronous method dispatch are transparent to the client, that is, the client cannot tell whether a server chose to process a request synchronously or asynchronously.

Oneway Method Invocation

Clients can invoke an operation as a *oneway* operation. A oneway invocation has “best effort” semantics. For a oneway invocation, the client-side run time hands the invocation to the local transport, and the invocation completes on the client side as soon as the local transport has buffered the invocation. The actual invocation is then sent asynchronously by the operating system. The server does not reply to oneway invocations, that is, traffic flows only from client to server, but not vice versa.

Oneway invocations are unreliable. For example, the target object may not exist, in which case the invocation is simply lost. Similarly, the operation may be dispatched to a servant in the server, but the operation may fail (for example, because parameter values are invalid); if so, the client receives no notification that something has gone wrong.

Oneway invocations are possible only on operations that do not have a return value, do not have out-parameters, and do not throw user exceptions (see Chapter 4).

To the application code on the server-side, oneway invocations are transparent, that is, there is no way to distinguish a twoway invocation from a oneway invocation.

Oneway invocations are available only if the target object offers a stream-oriented transport, such as TCP/IP or SSL.

Note that, even though oneway operations are sent over a stream-oriented transport, they may be processed out of order in the server. This can happen because each invocation may be dispatched in its own thread: even though the invocations are *initiated* in the order in which the invocations arrive at the server, this does not mean that they will be *processed* in that order—the vagaries of thread scheduling can result in a oneway invocation to complete before other oneway invocations that were received earlier.

Batched Oneway Method Invocation

Each oneway invocation sends a separate message to the server. For a series of short messages, the overhead of doing so is considerable: the client- and server-side run time each must switch between user mode and kernel mode for each message and, at the networking level, each message incurs the overheads of flow-control and acknowledgement.

Batched oneway invocations allow you to send a series of oneway invocations as a single message: every time you invoke a batched oneway operation, the invocation is buffered in the client-side run time. Once you have accumulated all the oneway invocations you want to send, you make a separate API call to send all the invocations at once. The client-side run time then sends all of the buffered invocations in a single message, and the server receives all of the invocations in a single message. This avoids the overhead of repeatedly trapping into the kernel for both client and server, and is much easier on the network between them because one large message can be transmitted more efficiently than many small ones.

The individual invocations in a batched oneway message are dispatched by a single thread in the order in which they were placed into the batch. This guarantees that the individual operations in a batched oneway message are processed in order in the server.

Batched oneway invocations are particularly useful for messaging services, such as IceStorm (see Chapter 43), and for fine-grained interfaces that offer set operations for small attributes.

Datagram Invocations

Datagram invocations have similar “best effort” semantics to oneway invocations. However, datagram invocations require the object to offer UDP as a transport (whereas oneway invocations require TCP/IP).

Like a oneway invocation, a datagram invocation can be made only if the operation does not have a return value, out-parameters, or user exceptions. A datagram invocation uses UDP to invoke the operation. The operation returns as soon as the local UDP stack has accepted the message; the actual operation invocation is sent asynchronously by the network stack behind the scenes.

Datagrams, like oneway invocations, are unreliable: the target object may not exist in the server, the server may not be running, or the operation may be invoked in the server but fail due to invalid parameters sent by the client. As for oneway invocations, the client receives no notification of such errors.

However, unlike oneway invocations, datagram invocations have a number of additional error scenarios:

- Individual invocations may simply be lost in the network.

This is due to the unreliable delivery of UDP packets. For example, if you invoke three operations in sequence, the middle invocation may be lost. (The same thing cannot happen for oneway invocations—because they are delivered over a connection-oriented transport, individual invocations cannot be lost.)

- Individual invocations may arrive out of order.

Again, this is due to the nature of UDP datagrams. Because each invocation is sent as a separate datagram, and individual datagrams can take different paths through the network, it can happen that invocations arrive in an order that differs from the order in which they were sent.

Datagram invocations are well suited for small messages on LANs, where the likelihood of loss is small. They are also suited to situations in which low latency is more important than reliability, such as for fast, interactive internet applications.

Batched Datagram Invocations

As for batched oneway invocations, *batched datagram invocations* allow you to accumulate a number of invocations in a buffer and then send the entire buffer as a single datagram by making an API call to flush the buffer. Batched datagrams reduce the overhead of repeated system calls and allow the underlying network to operate more efficiently. However, batched datagram invocations are useful only for batched messages whose total size does not substantially exceed the PDU limit of the network: if the size of a batched datagram gets too large, UDP fragmentation makes it more likely that one or more fragments are lost, which results in the loss of the entire batched message. However, you are guaranteed that either all

invocations in a batch will be delivered, or none will be delivered. It is impossible for individual invocations within a batch to be lost.

Batched datagrams use a single thread in the server to dispatch the individual invocations in a batch. This guarantees that the invocations are made in the order in which they were queued—invocations cannot appear to be reordered in the server.

Run-Time Exceptions

Any operation invocation can raise a *run-time exception*. Run-time exceptions are pre-defined by the Ice run time and cover common error conditions, such as connection failure, connection timeout, or resource allocation failure. Run-time exceptions are presented to the application as proper C++, Java, or C# exceptions and so integrate neatly with the native exception handling capabilities of these languages.

User Exceptions

User exceptions are used to indicate application-specific error conditions to clients. User exceptions can carry an arbitrary amount of complex data and can be arranged into inheritance hierarchies, which makes it easy for clients to handle categories of errors generically, by catching an exception that is further up the inheritance hierarchy. Like run-time exceptions, user exceptions map to native exceptions.

Properties

Much of the Ice run time is configurable via *properties*. Properties are name–value pairs, such as `Ice.Default.Protocol=tcp`. Properties are typically stored in text files and parsed by the Ice run time to configure various options, such as the thread pool size, the level of tracing, and various other configuration parameters.

2.2.3 Slice (Specification Language for Ice)

As mentioned on page 11, each Ice object has an interface with a number of operations. Interfaces, operations, and the types of data that are exchanged between client and server are defined using the *Slice language*. Slice allows you to define the client-server contract in a way that is independent of a specific programming language, such as C++, Java, or C#. The Slice definitions are compiled by a compiler into an API for a specific programming language, that is, the part of the

API that is specific to the interfaces and types you have defined consists of generated code.

2.2.4 Language Mappings

The rules that govern how each Slice construct is translated into a specific programming language are known as *language mappings*. For example, for the C++ mapping (see Chapter 6), a Slice sequence appears as an STL vector, whereas, for the Java mapping (see Chapter 10), a Slice sequence appears as a Java array. In order to determine what the API for a specific Slice construct looks like, you only need the Slice definition and knowledge of the language mapping rules. The rules are simple and regular enough to make it unnecessary to read the generated code to work out how to use the generated API.

Of course, you are free to peruse the generated code. However, as a rule, that is inefficient because the generated code is not necessarily suitable for human consumption. We recommend that you familiarize yourself with the language mapping rules; that way, you can mostly ignore the generated code and need to refer to it only when you are interested in some specific detail.

Currently, Ice provides language mappings for C++, Java, C#, Visual Basic .NET, Python, and, for the client side, PHP and Ruby.

2.2.5 Client and Server Structure

Ice clients and servers have the logical internal structure shown in Figure 2.1

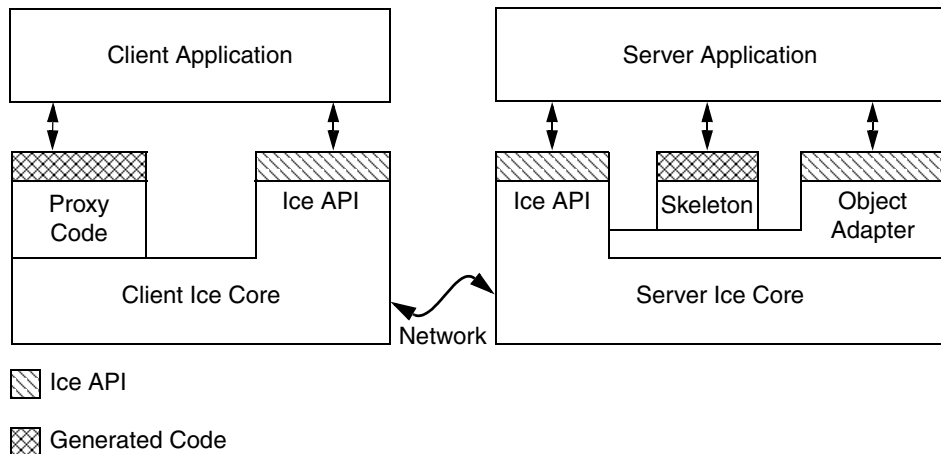

Figure 2.1. Ice Client and Server Structure

Both client and server consist of a mixture of application code, library code, and code generated from Slice definitions:

- The Ice core contains the client- and server-side run-time support for remote communication. Much of this code is concerned with the details of networking, threading, byte ordering, and many other networking-related issues that we want to keep away from application code. The Ice core is provided as a number of libraries that client and server link with.
- The generic part of the Ice core (that is, the part that is independent of the specific types you have defined in Slice) is accessed through the Ice API. You use the Ice API to take care of administrative chores, such as initializing and finalizing the Ice run time. The Ice API is identical for clients and servers (although servers use a larger part of the API than clients).
- The proxy code is generated from your Slice definitions and, therefore, specific to the types of objects and data you have defined in Slice. The proxy code has two major functions:
 - It provides a down-call interface for the client. Calling a function in the generated proxy API ultimately ends up sending an RPC message to the server that invokes a corresponding function on the target object.

- It provides *marshaling* and *unmarshaling* code.

Marshaling is the process of serializing a complex data structure, such as a sequence or a dictionary, for transmission on the wire. The marshaling code converts data into a form that is standardized for transmission and independent of the endian-ness and padding rules of the local machine.

Unmarshaling is the reverse of marshaling, that is, deserializing data that arrives over the network and reconstructing a local representation of the data in types that are appropriate for the programming language in use.

- The skeleton code is also generated from your Slice definition and, therefore, specific to the types of objects and data you have defined in Slice. The skeleton code is the server-side equivalent of the client-side proxy code: it provides an up-call interface that permits the Ice run time to transfer the thread of control to the application code you write. The skeleton also contains marshaling and unmarshaling code, so the server can receive parameters sent by the client, and return parameters and exceptions to the client.
- The object adapter is a part of the Ice API that is specific to the server side: only servers use object adapters. An object adapter has several functions:
 - The object adapter maps incoming requests from clients to specific methods on programming-language objects. In other words, the object adapter tracks which servants with what object identity are in memory.
 - The object adapter is associated with one or more transport endpoints. If more than one transport endpoint is associated with an adapter, the servants incarnating objects within the adapter can be reached via multiple transports. For example, you can associate both a TCP/IP and a UDP endpoint with an adapter, to provide alternate quality-of-service and performance characteristics.
 - The object adapter is responsible for the creation of proxies that can be passed to clients. The object adapter knows about the type, identity, and transport details of each of its objects and embeds the correct details when the server-side application code requests the creation of a proxy.

Note that, as far as the process view is concerned, there are only two processes involved: the client and the server. All the run time support for distributed communication is provided by the Ice libraries and the code that is generated from Slice definitions. (For indirect proxies, a third process, IceGrid, is required to resolve proxies to transport endpoints.)

2.2.6 The Ice Protocol

Ice provides an RPC protocol that can use either TCP/IP or UDP as an underlying transport. In addition, Ice also allows you to use SSL as a transport, so all communication between client and server are encrypted.

The Ice protocol defines:

- a number of message types, such as request and reply message types,
- a protocol state machine that determines in what sequence different message types are exchanged by client and server, together with the associated connection establishment and tear-down semantics for TCP/IP,
- encoding rules that determine how each type of data is represented on the wire,
- a header for each message type that contains details such as the message type, the message size, and the protocol and encoding version in use.

Ice also supports compression on the wire: by setting a configuration parameter, you can arrange for all network traffic to be compressed to conserve bandwidth. This is useful if your application exchanges large amounts of data between client and server.

The Ice protocol is suitable for building highly-efficient event forwarding mechanisms because it permits forwarding of a message without knowledge of the details of the information inside a message. This means that messaging switches need not do any unmarshaling and remarshaling of messages—they can forward a message by simply treating it as an opaque buffer of bytes.

The Ice protocol also supports bidirectional operation: if a server wants to send a message to a callback object provided by the client, the callback can be made over the connection that was originally created by the client. This feature is especially important when the client is behind a firewall that permits outgoing connections, but not incoming connections.

2.2.7 Object Persistence

Ice has a built-in object persistence service, known as *Freeze*. Freeze makes it easy to store object state in a database: you define the state stored by your objects in Slice, and the Freeze compiler generates code that stores and retrieves object state to and from a database. By default, Freeze uses Berkeley DB [18] as its database. However, if you prefer to store object state in another database, you can do so. We discuss Freeze in detail in Chapter 38.

Ice also offers a number of tools that make it easier to maintain databases and to migrate the contents of existing databases to a new schema if the type definitions of objects change. We discuss these tools in Chapter 39.

2.3 Ice Services

The Ice core provides a sophisticated client–server platform for distributed application development. However, realistic applications usually require more than just a remoting capability: typically, you also need a way to start servers on demand, distribute proxies to clients, distribute asynchronous events, configure your application, distribute patches for an application, and so on.

Ice ships with a number of services that provide these and other features. The services are implemented as Ice servers to which your application acts as a client. None of the services use Ice-internal features that are hidden from application developers so, in theory, you could develop equivalent services yourself. However, having these services available as part of the platform allows you to focus on application development instead of having to build a lot of infrastructure first. Moreover, building such services is not a trivial effort, so it pays to know what is available and use it instead of reinventing your own wheel.

2.3.1 IceGrid

IceGrid is an implementation of an Ice location service that resolves the symbolic information in an indirect proxy to a protocol–address pair for indirect binding. A location service is only the beginning of IceGrid’s capabilities:

- IceGrid allows you to register servers for automatic start-up: instead of requiring a server to be running at the time a client issues a request, IceGrid starts servers on demand, when the first client request arrives.
- IceGrid provides tools that make it easy to configure complex applications containing several servers.
- IceGrid supports replication and load-balancing.
- IceGrid automates the distribution and patching of server executables and dependent files.
- IceGrid provides a simple query service that allows clients to obtain proxies for objects they are interested in.

2.3.2 IceBox

IceBox is a simple application server that can orchestrate the starting and stopping of a number of application components. Application components can be deployed as a dynamic library instead of as a process. This reduces overall system load, for example, by allowing you to run several application components in a single Java virtual machine instead of having multiple processes, each with its own virtual machine.

2.3.3 IceStorm

IceStorm is a publish–subscribe service that decouples clients and servers. Fundamentally, IceStorm acts as a distribution switch for events. Publishers send events to the service, which, in turn, passes the events to subscribers. In this way, a single event published by a publisher can be sent to multiple subscribers. Events are categorized by topic, and subscribers specify the topics they are interested in. Only events that match a subscriber’s topic are sent to that subscriber. The service permits selection of a number of quality-of-service criteria to allow applications to choose the appropriate trade-off between reliability and performance.

IceStorm is particularly useful if you have a need to distribute information to large numbers of application components. (A typical example is a stock ticker application with a large number of subscribers.) IceStorm decouples the publishers of information from subscribers and takes care of the redistribution of the published events. In addition, IceStorm can be run as a *federated* service, that is, multiple instances of the service can be run on different machines to spread the processing load over a number of CPUs.

2.3.4 IcePatch2

IcePatch2³ is a software patching service. It allows you to easily distribute software updates to clients. Clients simply connect to the IcePatch2 server and request updates for a particular application. The service automatically checks the version of the client’s software and downloads any updated application components in a compressed format to conserve bandwidth. Software patches can be secured using the Glacier2 service, so only authorized clients can download software updates.

3. IcePatch2 supersedes IcePatch, which was a previous version of this service.

2.3.5 Glacier2

Glacier2⁴ is the Ice firewall service: it allows clients and servers to securely communicate through a firewall without compromising security. Client-server traffic is fully encrypted using public key certificates and is bidirectional. Glacier2 offers support for mutual authentication as well as secure session management.

2.4 Architectural Benefits of Ice

The Ice architecture provides a number of benefits to application developers:

- Object-oriented semantics

Ice fully preserves the object-oriented paradigm “across the wire.” All operation invocations use late binding, so the implementation of an operation is chosen depending on the actual run-time (not static) type of an object.

- Support for synchronous and asynchronous messaging

Ice provides both synchronous and asynchronous operation invocation and dispatch, as well as publish–subscribe messaging via IceStorm. This allows you to choose a communication model according to the needs of your application instead of having to shoe-horn the application to fit a single model.

- Support for multiple interfaces

With facets, objects can provide multiple, unrelated interfaces while retaining a single object identity across these interfaces. This provides great flexibility, particularly as an application evolves but needs to remain compatible with older, already deployed clients.

- Machine independence

Clients and servers are shielded from idiosyncrasies of the underlying machine architecture. Issues such as byte ordering and padding are hidden from application code.

- Language independence

Client and server can be developed independently and in different programming languages (currently C++, Java, C#, and, for the client side, PHP). The

4. Glacier2 supersedes Glacier, which was a previous version of this service.

Slice definition used by both client and server establishes the interface contract between them and is the only thing they need to agree on.

- Implementation independence

Clients are unaware of how servers implement their objects. This means that the implementation of a server can be changed after clients are deployed, for example, to use a different persistence mechanism or even a different programming language.

- Operating system independence

The Ice APIs are fully portable, so the same source code compiles and runs under both Windows and UNIX.

- Threading support

The Ice run time is fully threaded and APIs are thread-safe. No effort (beyond synchronizing access to shared data) is required on part of the application developer to develop threaded, high-performance clients and servers.

- Transport independence

Ice currently offers both TCP/IP and UDP as transport protocols. Neither client nor server code are aware of the underlying transport. (The desired transport can be chosen by a configuration parameter.)

- Location and server transparency

The Ice run time takes care of locating objects and managing the underlying transport mechanism, such as opening and closing connections. Interactions between client and server appear connection-less. Via IceGrid, you can arrange for servers to be started on demand if they are not running at the time a client invokes an operation. Servers can be migrated to different physical addresses without breaking proxies held by clients, and clients are completely unaware how object implementations are distributed over server processes.

- Security

Communications between client and server can be fully secured with strong encryption over SSL, so applications can use unsecured public networks to communicate securely. Via Glacier2, you can implement secure forwarding of requests through a firewall, with full support for callbacks.

- Built-in persistence

With Freeze, creating persistent object implementations becomes trivial. Ice comes with built-in support for Berkeley DB [18], which is a high-performance database.

- Source code availability

The source code for Ice is available. While it is not necessary to have access to the source code to use the platform, it allows you to see how things are implemented or port the code to a new operating system.

Overall, Ice provides a state-of-the-art development and deployment environment for distributed computing that is more complete than any other platform we are aware of.

2.5 A Comparison with CORBA

Obviously, Ice uses many ideas that can be found in CORBA and earlier distributed computing platforms, such as DCE [14]. In some areas, Ice is remarkably close to CORBA whereas, in others, the differences are profound and have far-reaching architectural implications. If you have used CORBA in the past, it is important to be aware of these differences.

2.5.1 Differences in the Object Model

The Ice object model, even though superficially the same, differs in a number of important points from the CORBA object model.

Type System

An Ice object, like a CORBA object, has exactly one most derived *main* interface. However, an Ice object can provide other interfaces as facets. It is important to notice that all facets of an Ice object share the same object identity, that is, the client sees a single object with multiple interfaces instead of several objects, each with a different interface.

Facets provide great architectural flexibility. In particular, they offer an approach to the versioning problem: it is easy to extend functionality in a server without breaking existing, already deployed clients by simply adding a new facet to an already existing object.

Proxy Semantics

Ice proxies (the equivalent of CORBA object references) are *not* opaque. Clients can always create a proxy without support from any other system component, as

long as they know the type and identity of the object. (For indirect binding, it is *not* necessary to be aware of the transport address of the object.)

Allowing clients to create proxies on demand has a number of advantages:

- Clients can create proxies without the need to consult an external look-up service, such as a naming service. In effect, the object identity and the object's name are considered to be one and the same. This eliminates the problems that can arise from having the contents of the naming service go out of sync with reality, and reduces the number of system components that must be functional for clients and servers to work correctly.
- Clients can easily bootstrap themselves by creating proxies to the initial objects they need. This eliminates the need for a separate bootstrap service.
- There is no need for different encodings of stringified proxies. A single, uniform representation is sufficient, and that representation is readable to humans. This avoids the complexities introduced by CORBA's three different object reference encodings (IOR, `corbaloc`, and `corbaname`).

Experience over many years with CORBA has shown that, pragmatically, opacity of object references is problematic: not only does it require more complex APIs and run-time support, it also gets in the way of building realistic systems. For that reason, mechanisms such as `corbaloc` and `corbaname` were added, as well as the (ill-defined) `is_equivalent` and `hash` operations for reference comparison. All of these mechanisms compromise the opacity of object references, but other parts of the CORBA platform still try to maintain the illusion of opaque references. As a result, the developer gets the worst of both worlds: references are neither fully opaque nor fully transparent—the resulting confusion and complexity are considerable.

Object Identity

The Ice object model assumes that object identities are universally unique (but without imposing this requirement on the application developer). The main advantage of universally unique object identities is that they permit you to migrate servers and to combine the objects in multiple separate servers into a single server without concerns about name collisions: if each Ice object has a unique identity, it is impossible for that identity to clash with the identity of another object in a different domain.

The Ice object model also uses *strong* object identity: it is possible to determine whether two proxies denote the same object as a local, client-side operation. (With CORBA, you must invoke operations on the remote objects to get reliable

identity comparison.) Local identity comparison is far more efficient and crucial for some application domains, such as a distributed transaction service.

2.5.2 Differences in Platform Support

CORBA, depending on which specification you choose to read, provides many of the services provided by Ice. For example, CORBA supports asynchronous method invocation and, with the component model, a form of multiple interfaces. However, the problem is that it is typically impossible to find these features in a single implementation. Too many CORBA specifications are either optional or not widely implemented so, as a developer, you are typically faced with having to choose which feature to do without.

Other features of Ice do not have direct CORBA equivalents:

- Asynchronous Method Dispatch (AMD)

The CORBA APIs do not provide any mechanism to suspend processing of an operation in the server, freeing the thread of control, and resuming processing of the operation later.

- Security

While there are many pages of specifications relating to security, most of them remain unimplemented to date. In particular, CORBA to date offers no practical solution that allows CORBA to coexist with firewalls.

- Protocol Features

The Ice protocol offers bidirectional support, which is a fundamental requirement for allowing callbacks through firewalls. (CORBA specified a bidirectional protocol at one point, but the specification was technically flawed and, to the best of our knowledge, never implemented.) In addition, Ice allows you to use UDP as well as TCP, so event distribution on reliable (local) networks can be made extremely efficient and light-weight. CORBA provides no support for UDP as a transport.

Another important feature of the Ice protocols is that all messages and data are fully encapsulated on the wire. This allows Ice to implement services such as IceStorm extremely efficiently because, to forward data, no unmarshaling and remarshaling is necessary. Encapsulation is also important for the deployment of protocol bridges, such as Glacier2, because the bridge does not need to be configured with type-specific information.

- Language Mappings

CORBA does not specify a language mapping for C#, Visual Basic, or PHP.

2.5.3 Differences in Complexity

CORBA is known as a platform that is large and complex. This is largely a result of the way CORBA is standardized: decisions are reached by consensus and majority vote. In practice, this means that, when a new technology is being standardized, the only way to reach agreement is to accommodate the pet features of all interested parties. The result are specifications that are large, complex, and burdened with redundant or useless features. In turn, all this complexity leads to implementations that are large and inefficient. The complexity of the specifications is reflected in the complexity of the CORBA APIs: even experts with years of experience still need to work with a reference manual close at hand, and, due to this complexity, applications are frequently plagued with latent bugs that do not show up until after deployment.

CORBA's object model adds further to CORBA's complexity. For example, opaque object references force the specification of a naming service because clients must have some way to access object references. In turn, this requires the developer to learn yet another API, and to configure and deploy yet another service when, as with the Ice object model, no naming service is necessary in the first place.

One of the most infamous areas of complexity in CORBA is the C++ mapping. The CORBA C++ API is arcane in the extreme; in particular, the memory management issues of this mapping are more than what many developers are willing to endure. Yet, the code required to implement the C++ mapping is neither particularly small nor efficient, leading to binaries that are larger and require more memory at run time than they should. If you have used CORBA with C++ in the past, you will appreciate the simplicity, efficiency, and neat integration with STL of the Ice C++ mapping.

In contrast to CORBA, Ice is first and foremost a simple platform. The designers of Ice took great care to pick a feature set that is both sufficient and minimal: you can do everything you want, and you can do it with the smallest and simplest possible API. As you start to use Ice, you will appreciate this simplicity. It makes it easy to learn and understand the platform, and it leads to shorter development time with lower defect counts in deployed applications. At the same time, Ice does not compromise on features: with Ice, you can achieve everything you can achieve with CORBA and do so with less effort, less code, and less

complexity. We see this as the most compelling advantage of Ice over any other middleware platform: things are simple, so simple, in fact, that you will be developing industrial-strength distributed applications after only a few days exposure to Ice.

Chapter 3

A Hello World Application

3.1 Chapter Overview

In this chapter, we will see how to create a very simple client–server application in C++ (Section 3.3), Java (Section 3.4), C# (Section 3.5), Visual Basic (Section 3.6), Python (Section 3.7), and Ruby (Section 3.8). Rather than reading the entire chapter, we suggest that you read Section 3.2 and then skip to the section that deals with the programming language of your choice.

The application enables remote printing: a client sends the text to be printed to a server, which in turn sends that text to a printer. For simplicity (and because we do not want to concern ourselves with the idiosyncrasies of print spoolers for various platforms), our printer will simply print to a terminal instead of a real printer. This is no great loss: the purpose of the exercise is to show how a client can communicate with a server; once the thread of control has reached the server application code, that code can of course do anything it likes (including sending the text to a real printer). How to do this is independent of Ice and therefore not relevant here.

Note that much of the detail of the source code will remain unexplained for now. The intent is to show you how to get started and give you a feel for what the development environment looks like; we will provide all the detail throughout the remainder of this book.

3.2 Writing a Slice Definition

The first step in writing any Ice application is to write a Slice definition containing the interfaces that are used by the application. For our minimal printing application, we write the following Slice definition:

```
module Demo {
    interface Printer {
        void printString(string s);
    };
};
```

We save this text in a file called `Printer.ice`.

Our Slice definitions consist of the module `Demo` containing a single interface called `Printer`. For now, the interface is very simple and provides only a single operation, called `printString`. The `printString` operation accepts a string as its sole input parameter; the text of that string is what appears on the (possibly remote) printer.

3.3 Writing an Ice Application with C++

This section shows how to create an Ice application with C++.

Compiling a Slice Definition for C++

The first step in creating our C++ application is to compile our Slice definition to generate C++ proxies and skeletons. Under UNIX, you can compile the definition as follows:

```
$ slice2cpp Printer.ice
```

The `slice2cpp` compiler produces two C++ source files from this definition, `Printer.h` and `Printer.cpp`.

- `Printer.h`

The `Printer.h` header file contains C++ type definitions that correspond to the Slice definitions for our `Printer` interface. This header file must be included in both the client and the server source code.

- `Printer.cpp`

The `Printer.cpp` file contains the source code for our `Printer` interface. The generated source contains type-specific run-time support for both clients

and servers. For example, it contains code that marshals parameter data (the string passed to the `printString` operation) on the client side and unmarshals that data on the server side.

The `Printer.cpp` file must be compiled and linked into both client and server.

Writing and Compiling a Server

The source code for the server takes only a few lines and is shown in full here:

```
#include <Ice/Ice.h>
#include <Printer.h>

using namespace std;
using namespace Demo;

class PrinterI : public Printer {
public:
    virtual void printString(const string& s,
                            const Ice::Current&);
};

void
PrinterI::
printString(const string& s, const Ice::Current&)
{
    cout << s << endl;
}

int
main(int argc, char* argv[])
{
    int status = 0;
    Ice::CommunicatorPtr ic;
    try {
        ic = Ice::initialize(argc, argv);
        Ice::ObjectAdapterPtr adapter
            = ic->createObjectAdapterWithEndpoints(
                "SimplePrinterAdapter", "default -p 10000");
        Ice::ObjectPtr object = new PrinterI;
        adapter->add(object, ic->stringToIdentity("SimplePrinter")
    );
        adapter->activate();
        ic->waitForShutdown();
    } catch (const Ice::Exception& e) {
```



```

        = Ice::Current()
    ) = 0;
};
};

```

The `Printer` skeleton class definition is generated by the Slice compiler. (Note that the `printString` method is pure virtual so the skeleton class cannot be instantiated.) Our servant class inherits from the skeleton class to provide an implementation of the pure virtual `printString` method. (By convention, we use an `I`-suffix to indicate that the class implements an interface.)

```

class PrinterI : public Printer {
public:
    virtual void printString(const string& s,
                            const Ice::Current&);
};

```

The implementation of the `printString` method is trivial: it simply writes its string argument to `stdout`:

```

void
PrinterI::
printString(const string& s, const Ice::Current&)
{
    cout << s << endl;
}

```

Note that `printString` has a second parameter of type `Ice::Current`. As you can see from the definition of `Printer::printString`, the Slice compiler generates a default argument for this parameter, so we can leave it unused in our implementation. (We will examine the purpose of the `Ice::Current` parameter in Section 31.6.)

What follows is the server main program. Note the general structure of the code:

```

int
main(int argc, char* argv[])
{
    int status = 0;
    Ice::CommunicatorPtr ic;
    try {

        // Server implementation here...

    } catch (const Ice::Exception& e) {
        cerr << e << endl;
    }
}

```

```
        status = 1;
    } catch (const char* msg) {
        cerr << msg << endl;
        status = 1;
    }
    if (ic) {
        try {
            ic->destroy();
        } catch (const Ice::Exception& e) {
            cerr << e << endl;
            status = 1;
        }
    }
    return status;
}
```

The body of `main` contains the declaration of two variables, `status` and `ic`. The `status` variable contains the exit status of the program and the `ic` variable, of type `Ice::CommunicatorPtr`, contains the main handle to the Ice run time.

Following these declarations is a `try` block in which we place all the server code, followed by two `catch` handlers. The first handler catches all exceptions that may be thrown by the Ice run time; the intent is that, if the code encounters an unexpected Ice run-time exception anywhere, the stack is unwound all the way back to `main`, which prints the exception and then returns failure to the operating system. The second handler catches string constants; the intent is that, if we encounter a fatal error condition somewhere in our code, we can simply throw a string literal with an error message. Again, this unwinds the stack all the way back to `main`, which prints the error message and then returns failure to the operating system.

Following the `try` block, we see a bit of cleanup code that calls the `destroy` method on the communicator (provided that the communicator was initialized). The cleanup call is outside the first `try` block for a reason: we must ensure that the Ice run time is finalized whether the code terminates normally or terminates due to an exception.¹

The body of the first `try` block contains the actual server code:

1. Failure to call `destroy` on the communicator before the program exits results in undefined behavior.

```
ic = Ice::initialize(argc, argv);
Ice::ObjectAdapterPtr adapter
    = ic->createObjectAdapterWithEndpoints(
        "SimplePrinterAdapter", "default -p 10000");
Ice::ObjectPtr object = new PrinterI;
adapter->add(object, ic->stringToIdentity("SimplePrinter")
);

adapter->activate();
ic->waitForShutdown();
```

The code goes through the following steps:

1. We initialize the Ice run time by calling `Ice::initialize`. (We pass `argc` and `argv` to this call because the server may have command-line arguments that are of interest to the run time; for this example, the server does not require any command-line arguments.) The call to `initialize` returns a smart pointer to an `Ice::Communicator` object, which is the main handle to the Ice run time.
2. We create an object adapter by calling `createObjectAdapterWithEndpoints` on the `Communicator` instance. The arguments we pass are `"SimplePrinterAdapter"` (which is the name of the adapter) and `"default -p 10000"`, which instructs the adapter to listen for incoming requests using the default protocol (TCP/IP) at port number 10000.
3. At this point, the server-side run time is initialized and we create a servant for our `Printer` interface by instantiating a `PrinterI` object.
4. We inform the object adapter of the presence of a new servant by calling `add` on the adapter; the arguments to `add` are the servant we have just instantiated, plus an identifier. In this case, the string `"SimplePrinter"` is the name of the servant. (If we had multiple printers, each would have a different name or, more correctly, a different *object identity*.)
5. Next, we activate the adapter by calling its `activate` method. (The adapter is initially created in a holding state; this is useful if we have many servants that share the same adapter and do not want requests to be processed until after all the servants have been instantiated.) The server starts to process incoming requests from clients as soon as the adapter is activated.
6. Finally, we call `waitForShutdown`. This call suspends the calling thread until the server implementation terminates, either by making a call to shut down the run time, or in response to a signal. (For now, we will simply interrupt the server on the command line when we no longer need it.)

Note that, even though there is quite a bit of code here, that code is essentially the same for all servers. You can put that code into a helper class and, thereafter, will not have to bother with it again. (Ice ships with such a helper class, called `Ice::Application`—see Section 8.3.1.) As far as actual application code is concerned, the server contains only a few lines: six lines for the definition of the `PrinterI` class, plus three² lines to instantiate a `PrinterI` object and register it with the object adapter.

Assuming that we have the server code in a file called `Server.cpp`, we can compile it as follows:

```
$ c++ -I. -I$ICE_HOME/include -c Printer.cpp Server.cpp
```

This compiles both our application code and the code that was generated by the Slice compiler. We assume that the `ICE_HOME` environment variable is set to the top-level directory containing the Ice run time. (For example, if you have installed Ice in `/opt/Ice`, set `ICE_HOME` to that path.) Depending on your platform, you may have to add additional include directives or other options to the compiler (such as an include directive for the STLport headers, or to control template instantiation); please see the demo programs that ship with Ice for the details.

Finally, we need to link the server into an executable:

```
$ c++ -o server Printer.o Server.o \
-L$ICE_HOME/lib -lIce -lIceUtil
```

Again, depending on the platform, the actual list of libraries you need to link against may be longer. The demo programs that ship with Ice contain all the detail. The important point to note here is that the Ice run time is shipped in two libraries, `libIce` and `libIceUtil`.

Writing and Compiling a Client

The client code looks very similar to the server. Here it is in full:

```
#include <Ice/Ice.h>
#include <Printer.h>

using namespace std;
using namespace Demo;

int
```

2. Well, two lines, really: printing space limitations force us to break source lines more often than you would in your actual source files.

```

main(int argc, char* argv[])
{
    int status = 0;
    Ice::CommunicatorPtr ic;
    try {
        ic = Ice::initialize(argc, argv);
        Ice::ObjectPrx base = ic->stringToProxy(
            "SimplePrinter:default -p 10000");
        PrinterPrx printer = PrinterPrx::checkedCast(base);
        if (!printer)
            throw "Invalid proxy";

        printer->printString("Hello World!");
    } catch (const Ice::Exception& ex) {
        cerr << ex << endl;
        status = 1;
    } catch (const char* msg) {
        cerr << msg << endl;
        status = 1;
    }
    if (ic)
        ic->destroy();
    return status;
}

```

Note that the overall code layout is the same as for the server: we include the headers for the Ice run time and the header generated by the Slice compiler, and we use the same `try` block and `catch` handlers to deal with errors.

The code in the `try` block does the following:

1. As for the server, we initialize the Ice run time by calling `Ice::initialize`.
2. The next step is to obtain a proxy for the remote printer. We create a proxy by calling `stringToProxy` on the communicator, with the string `"SimplePrinter:default -p 10000"`. Note that the string contains the object identity and the port number that were used by the server. (Obviously, hard-coding object identities and port numbers into our applications is a bad idea, but it will do for now; we will see more architecturally sound ways of doing this in Chapter 37.)
3. The proxy returned by `stringToProxy` is of type `Ice::ObjectPrx`, which is at the root of the inheritance tree for interfaces and classes. But to actually talk to our printer, we need a proxy for a `Printer` interface, not an `Object` interface. To do this, we need to do a down-cast by calling `Print-`

`erPrx::checkedCast`. A checked cast sends a message to the server, effectively asking “is this a proxy for a `Printer` interface?” If so, the call returns a proxy to a `Printer`; otherwise, if the proxy denotes an interface of some other type, the call returns a null proxy.

4. We test that the down-cast succeeded and, if not, throw an error message that terminates the client.
5. We now have a live proxy in our address space and can call the `printString` method, passing it the time-honored “Hello World!” string. The server prints that string on its terminal.

Compiling and linking the client looks much the same as for the server:

```
$ ++ -I. -I$ICE_HOME/include -c Printer.cpp Client.cpp
$ ++ -o client Printer.o Client.o -L$ICE_HOME/lib -lIce -lIceUtil
```

Running Client and Server

To run client and server, we first start the server in a separate window:

```
$ ./server
```

At this point, we won’t see anything because the server simply waits for a client to connect to it. We run the client in a different window:

```
$ ./client
$
```

The client runs and exits without producing any output; however, in the server window, we see the “Hello World!” that is produced by the printer. To get rid of the server, we interrupt it on the command line for now. (We will see cleaner ways to terminate a server in Section 8.3.1.)

If anything goes wrong, the client will print an error message. For example, if we run the client without having first started the server, we get:

```
Network.cpp:471: Ice::ConnectFailedException:
connect failed: Connection refused
```

Note that, to successfully run client and server, you will have to set some platform-dependent environment variables. For example, under Linux, you need to add the Ice library directory to your `LD_LIBRARY_PATH`. Please have a look at the demo applications that ship with Ice for the details for your platform.

3.4 Writing an Ice Application with Java

This section shows how to create an Ice application with Java.

Compiling a Slice Definition for Java

The first step in creating our Java application is to compile our Slice definition to generate Java proxies and skeletons. Under UNIX, you can compile the definition as follows:³

```
$ mkdir generated
$ slice2java --output-dir generated Printer.ice
```

The `--output-dir` option instructs the compiler to place the generated files into the `generated` directory. This avoids cluttering the working directory with the generated files. The `slice2java` compiler produces a number of Java source files from this definition. The exact contents of these files do not concern us for now—they contain the generated code that corresponds to the `Printer` interface we defined in `Printer.ice`.

Writing and Compiling a Server

To implement our `Printer` interface, we must create a servant class. By convention, servant classes use the name of their interface with an `I`-suffix, so our servant class is called `PrinterI` and placed into a source file `PrinterI.java`:

```
public class PrinterI extends Demo._PrinterDisp {
    public void
    printString(String s, Ice.Current current)
    {
        System.out.println(s);
    }
}
```

The `PrinterI` class inherits from a base class called `_PrinterDisp`, which is generated by the `slice2java` compiler. The base class is abstract and contains a `printString` method that accepts a string for the printer to print and a parameter of type `Ice.Current`. (For now we will ignore the `Ice.Current` parameter. We will see its purpose in detail in Section 31.6.) Our

3. Whenever we show UNIX commands in this book, we assume a Bourne or Bash shell. The commands for Windows are essentially identical and therefore not shown.

implementation of the `printString` method simply writes its argument to the terminal.

The remainder of the server code is in a source file called `Server.java`, shown in full here:

```
public class Server {
    public static void
    main(String[] args)
    {
        int status = 0;
        Ice.Communicator ic = null;
        try {
            ic = Ice.Util.initialize(args);
            Ice.ObjectAdapter adapter
                = ic.createObjectAdapterWithEndpoints(
                    "SimplePrinterAdapter", "default -p 10000");
            Ice.Object object = new PrinterI();
            adapter.add(
                object,
                Ice.Util.stringToIdentity("SimplePrinter"));
            adapter.activate();
            ic.waitForShutdown();
        } catch (Ice.LocalException e) {
            e.printStackTrace();
            status = 1;
        } catch (Exception e) {
            System.err.println(e.getMessage());
            status = 1;
        }
        if (ic != null) {
            // Clean up
            //
            try {
                ic.destroy();
            } catch (Exception e) {
                System.err.println(e.getMessage());
                status = 1;
            }
        }
        System.exit(status);
    }
}
```

Note the general structure of the code:

```
public class Server {
    public static void
    main(String[] args) {
        int status = 0;
        Ice.Communicator ic = null;
        try {

            // Server implementation here...

        } catch (Ice.LocalException e) {
            e.printStackTrace();
            status = 1;
        } catch (Exception e) {
            System.err.println(e.getMessage());
            status = 1;
        }
        if (ic != null) {
            // Clean up
            //
            try {
                ic.destroy();
            } catch (Exception e) {
                System.err.println(e.getMessage());
                status = 1;
            }
        }
        System.exit(status);
    }
}
```

The body of `main` contains a `try` block in which we place all the server code, followed by two `catch` blocks. The first block catches all exceptions that may be thrown by the Ice run time; the intent is that, if the code encounters an unexpected Ice run-time exception anywhere, the stack is unwound all the way back to `main`, which prints the exception and then returns failure to the operating system. The second block catches `Exception` exceptions; the intent is that, if we encounter a fatal error condition somewhere in our code, we can simply throw an exception with an error message. Again, this unwinds the stack all the way back to `main`, which prints the error message and then returns failure to the operating system.

Before the code exits, it destroys the communicator (if one was created successfully). Doing this is essential in order to correctly finalize the Ice run time: the program *must* call `destroy` on any communicator it has created; otherwise, undefined behavior results.

The body of our `try` block contains the actual server code:

```
ic = Ice.Util.initialize(args);
Ice.ObjectAdapter adapter
    = ic.createObjectAdapterWithEndpoints(
        "SimplePrinterAdapter", "default -p 10000");
Ice.Object object = new PrinterI();
adapter.add(
    object,
    Ice.Util.stringToIdentity("SimplePrinter"));
adapter.activate();
ic.waitForShutdown();
```

The code goes through the following steps:

1. We initialize the Ice run time by calling `Ice.Util.initialize`. (We pass `args` to this call because the server may have command-line arguments that are of interest to the run time; for this example, the server does not require any command-line arguments.) The call to `initialize` returns an `Ice::Communicator` reference, which is the main handle to the Ice run time.
2. We create an object adapter by calling `createObjectAdapterWithEndpoints` on the `Communicator` instance. The arguments we pass are `"SimplePrinterAdapter"` (which is the name of the adapter) and `"default -p 10000"`, which instructs the adapter to listen for incoming requests using the default protocol (TCP/IP) at port number 10000.
3. At this point, the server-side run time is initialized and we create a servant for our `Printer` interface by instantiating a `PrinterI` object.
4. We inform the object adapter of the presence of a new servant by calling `add` on the adapter; the arguments to `add` are the servant we have just instantiated, plus an identifier. In this case, the string `"SimplePrinter"` is the name of the servant. (If we had multiple printers, each would have a different name or, more correctly, a different *object identity*.)
5. Next, we activate the adapter by calling its `activate` method. (The adapter is initially created in a holding state; this is useful if we have many servants that share the same adapter and do not want requests to be processed until after all the servants have been instantiated.)
6. Finally, we call `waitForShutdown`. This call suspends the calling thread until the server implementation terminates, either by making a call to shut down the run time, or in response to a signal. (For now, we will simply interrupt the server on the command line when we no longer need it.)

Note that, even though there is quite a bit of code here, that code is essentially the same for all servers. You can put that code into a helper class and, thereafter, will not have to bother with it again. (Ice ships with such a helper class, called `Ice.Application`—see Section 12.3.1.) As far as actual application code is concerned, the server contains only a few lines: seven lines for the definition of the `PrinterI` class, plus four⁴ lines to instantiate a `PrinterI` object and register it with the object adapter.

We can compile the server code as follows:

```
$ mkdir classes
$ javac -d classes -classpath classes:$ICEJ_HOME/lib/Ice.jar\
-source 1.4 Server.java PrinterI.java generated/Demo/*.java
```

This compiles both our application code and the code that was generated by the Slice compiler. We assume that the `ICEJ_HOME` environment variable is set to the top-level directory containing the Ice run time. (For example, if you have installed Ice in `/opt/Icej`, set `ICEJ_HOME` to that path.) Note that Ice for Java uses the `ant` build environment to control building of source code. (`ant` is similar to `make`, but more flexible for Java applications.) You can have a look at the demo code that ships with Ice to see how to use this tool.

Writing and Compiling a Client

The client code, in `Client.java`, looks very similar to the server. Here it is in full:

```
public class Client {
    public static void
    main(String[] args)
    {
        int status = 0;
        Ice.Communicator ic = null;
        try {
            ic = Ice.Util.initialize(args);
            Ice.ObjectPrx base = ic.stringToProxy(
                "SimplePrinter:default -p 10000");
            Demo.PrinterPrx printer
                = Demo.PrinterPrxHelper.checkedCast(base);
            if (printer == null)
                throw new Error("Invalid proxy");
        }
    }
}
```

4. Well, two lines, really: printing space limitations force us to break source lines more often than you would in your actual source files.

```

        printer.printString("Hello World!");
    } catch (Ice.LocalException e) {
        e.printStackTrace();
        status = 1;
    } catch (Exception e) {
        System.err.println(e.getMessage());
        status = 1;
    }
    if (ic != null) {
        // Clean up
        //
        try {
            ic.destroy();
        } catch (Exception e) {
            System.err.println(e.getMessage());
            status = 1;
        }
    }
    System.exit(status);
}
}

```

Note that the overall code layout is the same as for the server: we use the same `try` and `catch` blocks to deal with errors. The code in the `try` block does the following:

1. As for the server, we initialize the Ice run time by calling `Ice.Util.initialize`.
2. The next step is to obtain a proxy for the remote printer. We create a proxy by calling `stringToProxy` on the communicator, with the string `"SimplePrinter:default -p 10000"`. Note that the string contains the object identity and the port number that were used by the server. (Obviously, hard-coding object identities and port numbers into our applications is a bad idea, but it will do for now; we will see more architecturally sound ways of doing this in Chapter 37.)
3. The proxy returned by `stringToProxy` is of type `Ice::ObjectPrx`, which is at the root of the inheritance tree for interfaces and classes. But to actually talk to our printer, we need a proxy for a `Printer` interface, not an `Object` interface. To do this, we need to do a down-cast by calling `PrinterPrxHelper.checkedCast`. A checked cast sends a message to the server, effectively asking “is this a proxy for a `Printer` interface?” If so, the call

returns a proxy of type `Demo::Printer`; otherwise, if the proxy denotes an interface of some other type, the call returns null.

4. We test that the down-cast succeeded and, if not, throw an error message that terminates the client.
5. We now have a live proxy in our address space and can call the `printString` method, passing it the time-honored "Hello World!" string. The server prints that string on its terminal.

Compiling the client looks much the same as for the server:

```
$ javac -d classes -classpath classes:$ICEJ_HOME/lib/Ice.jar \
-source 1.4 Client.java PrinterI.java generated/Demo/*.java
```

Running Client and Server

To run client and server, we first start the server in a separate window:

```
$ java Server
```

At this point, we won't see anything because the server simply waits for a client to connect to it. We run the client in a different window:

```
$ java Client
$
```

The client runs and exits without producing any output; however, in the server window, we see the "Hello World!" that is produced by the printer. To get rid of the server, we interrupt it on the command line for now. (We will see cleaner ways to terminate a server in Chapter 12.)

If anything goes wrong, the client will print an error message. For example, if we run the client without having first started the server, we get something like the following:

```
Ice.ConnectFailedException
    at IceInternal.Network.doConnect(Network.java:201)
    at IceInternal.TcpConnector.connect(TcpConnector.java:26)
    at
IceInternal.OutgoingConnectionFactory.create(OutgoingConnectionFac
tory.java:80)
    at Ice._ObjectDelM.setup(_ObjectDelM.java:251)
    at Ice.ObjectPrxHelper.__getDelegate(ObjectPrxHelper.java:
642)
    at Ice.ObjectPrxHelper.ice_isA(ObjectPrxHelper.java:41)
    at Ice.ObjectPrxHelper.ice_isA(ObjectPrxHelper.java:30)
    at Demo.PrinterPrxHelper.checkedCast(Unknown Source)
    at Client.main(Unknown Source)
```

```
Caused by: java.net.ConnectException: Connection refused
    at sun.nio.ch.SocketChannelImpl.checkConnect(Native Method)
    )
    at
sun.nio.ch.SocketChannelImpl.finishConnect(SocketChannelImpl.java:
518)
    at IceInternal.Network.doConnect(Network.java:173)
    ... 8 more
```

Note that, to successfully run client and server, your **CLASSPATH** must include the Ice library and the classes directory, for example:

```
$ export CLASSPATH=$CLASSPATH:./classes:$ICEJ_HOME/lib/Ice.jar
```

Please have a look at the demo applications that ship with Ice for the details for your platform.

3.5 Writing an Ice Application with C#

This section shows how to create an Ice application with C#.

Compiling a Slice Definition for C#

The first step in creating our C# application is to compile our Slice definition to generate C# proxies and skeletons. You can compile the definition as follows:⁵

```
$ mkdir generated
$ slice2cs --output-dir generated Printer.ice
```

The **--output-dir** option instructs the compiler to place the generated files into the `generated` directory. This avoids cluttering the working directory with the generated files. The `slice2cs` compiler produces a single source file, `Printer.cs`, from this definition. The exact contents of this file do not concern us for now—it contains the generated code that corresponds to the `Printer` interface we defined in `Printer.ice`.

5. Whenever we show UNIX commands in this book, we assume a Bourne or Bash shell. The commands for Windows are essentially identical and therefore not shown.

Writing and Compiling a Server

To implement our `Printer` interface, we must create a servant class. By convention, servant classes use the name of their interface with an `I`-suffix, so our servant class is called `PrinterI` and placed into a source file `Server.cs`:

```
using System;

public class PrinterI : Demo.PrinterDisp_
{
    public override void printString(string s, Ice.Current current)
    {
        Console.WriteLine(s);
    }
}
```

The `PrinterI` class inherits from a base class called `_PrinterDisp`, which is generated by the `slice2cs` compiler. The base class is abstract and contains a `printString` method that accepts a string for the printer to print and a parameter of type `Ice.Current`. (For now we will ignore the `Ice.Current` parameter. We will see its purpose in detail in Section 31.6.) Our implementation of the `printString` method simply writes its argument to the terminal.

The remainder of the server code follows in `Server.cs` and is shown in full here:

```
public class Server
{
    public static void Main(string[] args)
    {
        int status = 0;
        Ice.Communicator ic = null;
        try {
            ic = Ice.Util.initialize(ref args);
            Ice.ObjectAdapter adapter
                = ic.createObjectAdapterWithEndpoints(
                    "SimplePrinterAdapter", "default -p 10000");
            Ice.Object obj = new PrinterI();
            adapter.add(
                obj,
                Ice.Util.stringToIdentity("SimplePrinter"));
            adapter.activate();
            ic.waitForShutdown();
        } catch (Exception e) {
            Console.Error.WriteLine(e);
            status = 1;
        }
    }
}
```

```
    }
    if (ic != null) {
        // Clean up
        //
        try {
            ic.destroy();
        } catch (Exception e) {
            Console.Error.WriteLine(e);
            status = 1;
        }
    }
    Environment.Exit(status);
}
}
```

Note the general structure of the code:

```
public class Server
{
    public static void Main(string[] args)
    {
        int status = 0;
        Ice.Communicator ic = null;
        try {

            // Server implementation here...

        } catch (Exception e) {
            Console.Error.WriteLine(e);
            status = 1;
        }
        if (ic != null) {
            // Clean up
            //
            try {
                ic.destroy();
            } catch (Exception e) {
                Console.Error.WriteLine(e);
                status = 1;
            }
        }
        Environment.Exit(status);
    }
}
```

The body of `Main` contains a `try` block in which we place all the server code, followed by a `catch` block. The `catch` block catches all exceptions that may be thrown by the code; the intent is that, if the code encounters an unexpected run-time exception anywhere, the stack is unwound all the way back to `Main`, which prints the exception and then returns failure to the operating system.

Before the code exits, it destroys the communicator (if one was created successfully). Doing this is essential in order to correctly finalize the Ice run time: the program *must* call `destroy` on any communicator it has created; otherwise, undefined behavior results.

The body of our `try` block contains the actual server code:

```
ic = Ice.Util.initialize(ref args);
Ice.ObjectAdapter adapter
    = ic.createObjectAdapterWithEndpoints(
        "SimplePrinterAdapter", "default -p 10000");
Ice.Object obj = new PrinterI();
adapter.add(
    obj,
    Ice.Util.stringToIdentity("SimplePrinter"));
adapter.activate();
ic.waitForShutdown();
```

The code goes through the following steps:

1. We initialize the Ice run time by calling `Ice.Util.initialize`. (We pass `args` to this call because the server may have command-line arguments that are of interest to the run time; for this example, the server does not require any command-line arguments.) The call to `initialize` returns an `Ice::Communicator` reference, which is the main handle to the Ice run time.
2. We create an object adapter by calling `createObjectAdapterWithEndpoints` on the `Communicator` instance. The arguments we pass are `"SimplePrinterAdapter"` (which is the name of the adapter) and `"default -p 10000"`, which instructs the adapter to listen for incoming requests using the default protocol (TCP/IP) at port number 10000.
3. At this point, the server-side run time is initialized and we create a servant for our `Printer` interface by instantiating a `PrinterI` object.
4. We inform the object adapter of the presence of a new servant by calling `add` on the adapter; the arguments to `add` are the servant we have just instantiated, plus an identifier. In this case, the string `"SimplePrinter"` is the name of the servant. (If we had multiple printers, each would have a different name or, more correctly, a different *object identity*.)

5. Next, we activate the adapter by calling its `activate` method. (The adapter is initially created in a holding state; this is useful if we have many servants that share the same adapter and do not want requests to be processed until after all the servants have been instantiated.)
6. Finally, we call `waitForShutdown`. This call suspends the calling thread until the server implementation terminates, either by making a call to shut down the run time, or in response to a signal. (For now, we will simply interrupt the server on the command line when we no longer need it.)

Note that, even though there is quite a bit of code here, that code is essentially the same for all servers. You can put that code into a helper class and, thereafter, will not have to bother with it again. (Ice ships with such a helper class, called `Ice.Application`—see Section 16.3.1.) As far as actual application code is concerned, the server contains only a few lines: seven lines for the definition of the `PrinterI` class, plus four⁶ lines to instantiate a `PrinterI` object and register it with the object adapter.

We can compile the server code as follows:

```
$ csc /reference:icecs.dll /lib:$ICICLE_HOME/lib Server.cs \
generated/Printer.cs
```

This compiles both our application code and the code that was generated by the Slice compiler. We assume that the `ICICLE_HOME` environment variable is set to the top-level directory containing the Ice run time. (For example, if you have installed Ice in `/opt/Icicle`, set `ICICLE_HOME` to that path.)

Writing and Compiling a Client

The client code, in `Client.cs`, looks very similar to the server. Here it is in full:

```
using System;
using Demo;

public class Client
{
    public static void Main(string[] args)
    {
        int status = 0;
        Ice.Communicator ic = null;
```

6. Well, two lines, really: printing space limitations force us to break source lines more often than you would in your actual source files.

```
try {
    ic = Ice.Util.initialize(ref args);
    Ice.ObjectPrx obj = ic.stringToProxy(
        "SimplePrinter:default -p 10000");
    PrinterPrx printer
        = PrinterPrxHelper.checkedCast(obj);
    if (printer == null)
        throw new ApplicationException("Invalid proxy");

    printer.printString("Hello World!");
} catch (Exception e) {
    Console.Error.WriteLine(e);
    status = 1;
}
if (ic != null) {
    // Clean up
    //
    try {
        ic.destroy();
    } catch (Exception e) {
        Console.Error.WriteLine(e);
        status = 1;
    }
}
Environment.Exit(status);
}
```

Note that the overall code layout is the same as for the server: we use the same `try` and `catch` blocks to deal with errors. The code in the `try` block does the following:

1. As for the server, we initialize the Ice run time by calling `Ice.Util.initialize`.
2. The next step is to obtain a proxy for the remote printer. We create a proxy by calling `stringToProxy` on the communicator, with the string `"SimplePrinter:default -p 10000"`. Note that the string contains the object identity and the port number that were used by the server. (Obviously, hard-coding object identities and port numbers into our applications is a bad idea, but it will do for now; we will see more architecturally sound ways of doing this in Chapter 37.)
3. The proxy returned by `stringToProxy` is of type `Ice::ObjectPrx`, which is at the root of the inheritance tree for interfaces and classes. But to actually talk

to our printer, we need a proxy for a `Printer` interface, not an `Object` interface. To do this, we need to do a down-cast by calling `PrinterPrxHelper.checkedCast`. A checked cast sends a message to the server, effectively asking “is this a proxy for a `Printer` interface?” If so, the call returns a proxy of type `Demo::Printer`; otherwise, if the proxy denotes an interface of some other type, the call returns null.

4. We test that the down-cast succeeded and, if not, throw an error message that terminates the client.
5. We now have a live proxy in our address space and can call the `printString` method, passing it the time-honored “Hello World!” string. The server prints that string on its terminal.

Compiling the client looks much the same as for the server:

```
$ csc /reference:icecs.dll /lib:$ICICLE_HOME/lib Client.cs \
generated/Printer.cs
```

Running Client and Server

To run client and server, we first start the server in a separate window:

```
$ ./server.exe
```

At this point, we won’t see anything because the server simply waits for a client to connect to it. We run the client in a different window:

```
$ ./client.exe
$
```

The client runs and exits without producing any output; however, in the server window, we see the “Hello World!” that is produced by the printer. To get rid of the server, we interrupt it on the command line for now. (We will see cleaner ways to terminate a server in Chapter 16.)

If anything goes wrong, the client will print an error message. For example, if we run the client without having first started the server, we get something like the following:

```
Ice.ConnectFailedException: Connect failed: connection refused
   at IceInternal.ProxyFactory.checkRetryAfterException(LocalException ex, Int32 cnt)
   at Ice.ObjectPrxHelperBase.__handleException(LocalException ex, Int32 cnt)
   at Ice.ObjectPrxHelperBase.ice_isA(String __id, Context __conte
```



```
xt)
  at Ice.ObjectPrxHelperBase.ice_isA(String __id)
  at Demo.PrinterPrxHelper.checkedCast(ObjectPrx b)
  at Client.Main(String[] args)
```

Note that, to successfully run client and server, the C# run time must be able to locate the `Icecs.dll` library. (Under Windows, the simplest way to ensure this is to copy the library into the current directory. Please consult the documentation for your C# run time to see how it locates libraries.)

3.6 Writing an Ice Application with Visual Basic

This section shows how to create an Ice application with Visual Basic.

Compiling a Slice Definition for Visual Basic

The first step in creating our VB application is to compile our Slice definition to generate VB proxies and skeletons. You can compile the definition as follows:⁷

```
$ mkdir generated
$ slice2vb --output-dir generated Printer.ice
```

The `--output-dir` option instructs the compiler to place the generated files into the `generated` directory. This avoids cluttering the working directory with the generated files. The `slice2vb` compiler produces a single source file, `Printer.vb`, from this definition. The exact contents of this file do not concern us for now—it contains the generated code that corresponds to the `Printer` interface we defined in `Printer.ice`.

Writing and Compiling a Server

To implement our `Printer` interface, we must create a servant class. By convention, servant classes use the name of their interface with an `I`-suffix, so our servant class is called `PrinterI` and placed into a source file `Server.vb`:

7. Whenever we show UNIX commands in this book, we assume a Bourne or Bash shell. The commands for Windows are essentially identical and therefore not shown.

```

Imports System
Imports Demo

Public Class PrinterI
    Inherits PrinterDisp_

    Public Overloads Overrides Sub printString( _
        ByVal s As String, _
        ByVal current As Ice.Current)
        Console.WriteLine(s)
    End Sub

End Class

```

The `PrinterI` class inherits from a base class called `_PrinterDisp`, which is generated by the `slice2vb` compiler. The base class is abstract and contains a `printString` method that accepts a string for the printer to print and a parameter of type `Ice.Current`. (For now we will ignore the `Ice.Current` parameter. We will see its purpose in detail in Section 31.6.) Our implementation of the `printString` method simply writes its argument to the terminal.

The remainder of the server code follows in `Server.vb` and is shown in full here:

```

Module Server

    Public Sub Main(ByVal args() As String)

        Dim status As Integer = 0
        Dim ic As Ice.Communicator = Nothing
        Try
            ic = Ice.Util.initialize(args)
            Dim adapter As Ice.ObjectAdapter = _
                ic.createObjectAdapterWithEndpoints( _
                    "SimplePrinterAdapter", "default -p 10000")
            Dim obj As Ice.Object = New PrinterI
            adapter.add(obj, Ice.Util.stringToIdentity( _
                "SimplePrinter"))

            adapter.activate()
            ic.waitForShutdown()
        Catch e As Exception
            Console.Error.WriteLine(e)
            status = 1
        End Try
        If Not ic Is Nothing Then
            ' Clean up

```

```
        '
        Try
            ic.destroy()
        Catch e As Exception
            Console.Error.WriteLine(e)
            status = 1
        End Try
    End If
    Environment.Exit(status)
End Sub

End module
```

Note the general structure of the code:

```
Module Server

    Public Sub Main(ByVal args() As String)

        Dim status As Integer = 0
        Dim ic As Ice.Communicator = Nothing
        Try

            ' Server implementation here...

        Catch e As Exception
            Console.Error.WriteLine(e)
            status = 1
        End Try
        If Not ic Is Nothing Then
            ' Clean up
            '
            Try
                ic.destroy()
            Catch e As Exception
                Console.Error.WriteLine(e)
                status = 1
            End Try
        End If
        Environment.Exit(status)
    End Sub

End module
```

The body of Main contains a Try block in which we place all the server code, followed by a Catch block. The catch block catches all exceptions that may be

thrown by the code; the intent is that, if the code encounters an unexpected run-time exception anywhere, the stack is unwound all the way back to `Main`, which prints the exception and then returns failure to the operating system.

Before the code exits, it destroys the communicator (if one was created successfully). Doing this is essential in order to correctly finalize the Ice run time: the program *must* call `destroy` on any communicator it has created; otherwise, undefined behavior results.

The body of our `Try` block contains the actual server code:

```
ic = Ice.Util.initialize(args)
Dim adapter As Ice.ObjectAdapter = _
    ic.createObjectAdapterWithEndpoints( _
        "SimplePrinterAdapter", "default -p 10000")
Dim obj As Ice.Object = New PrinterI
adapter.add(obj, Ice.Util.stringToIdentity( _
    "SimplePrinter"))

adapter.activate()
ic.waitForShutdown()
```

The code goes through the following steps:

1. We initialize the Ice run time by calling `Ice.Util.initialize`. (We pass `args` to this call because the server may have command-line arguments that are of interest to the run time; for this example, the server does not require any command-line arguments.) The call to `initialize` returns an `Ice::Communicator` reference, which is the main handle to the Ice run time.
2. We create an object adapter by calling `createObjectAdapterWithEndpoints` on the `Communicator` instance. The arguments we pass are `"SimplePrinterAdapter"` (which is the name of the adapter) and `"default -p 10000"`, which instructs the adapter to listen for incoming requests using the default protocol (TCP/IP) at port number 10000.
3. At this point, the server-side run time is initialized and we create a servant for our `Printer` interface by instantiating a `PrinterI` object.
4. We inform the object adapter of the presence of a new servant by calling `add` on the adapter; the arguments to `add` are the servant we have just instantiated, plus an identifier. In this case, the string `"SimplePrinter"` is the name of the servant. (If we had multiple printers, each would have a different name or, more correctly, a different *object identity*.)
5. Next, we activate the adapter by calling its `activate` method. (The adapter is initially created in a holding state; this is useful if we have many servants

that share the same adapter and do not want requests to be processed until after all the servants have been instantiated.)

6. Finally, we call `waitForShutdown`. This call suspends the calling thread until the server implementation terminates, either by making a call to shut down the run time, or in response to a signal. (For now, we will simply interrupt the server on the command line when we no longer need it.)

Note that, even though there is quite a bit of code here, that code is essentially the same for all servers. You can put that code into a helper class and, thereafter, will not have to bother with it again. (Ice ships with such a helper class, called `Ice.Application`—see Section 16.3.1.) As far as actual application code is concerned, the server contains only a few lines: ten lines for the definition of the `PrinterI` class, plus three⁸ lines to instantiate a `PrinterI` object and register it with the object adapter.

We can compile the server code as follows:

```
$ vbc /reference:Icecs.dll /lib:$ICICLE_HOME/lib Server.vb \
generated/Printer.vb
```

This compiles both our application code and the code that was generated by the Slice compiler. We assume that the `ICICLE_HOME` environment variable is set to the top-level directory containing the Ice run time. (For example, if you have installed Ice in `/opt/Icicle`, set `ICICLE_HOME` to that path.)

Writing and Compiling a Client

The client code, in `Client.vb`, looks very similar to the server. Here it is in full:

```
Imports System
Imports Demo

Module Client

    Public Sub Main(ByVal args() As String)
        Dim status As Integer = 0
        Dim ic As Ice.Communicator = Nothing
        Try
            ic = Ice.Util.initialize(args)
            Dim obj As Ice.ObjectPrx = ic.stringToProxy( _
                "SimplePrinter:default -p 10000")
```

8. Well, two lines, really: printing space limitations force us to break source lines more often than you would in your actual source files.

```

        Dim printer As PrinterPrx = _
            PrinterPrxHelper.checkedCast(obj)
    If printer Is Nothing Then
        Throw New ApplicationException("Invalid proxy")
    End If

    printer.printString("Hello World!")
Catch e As Exception
    Console.Error.WriteLine(e)
    status = 1
End Try
If Not ic Is Nothing Then
    ' Clean up
    '
    Try
        ic.destroy()
    Catch e As Exception
        Console.Error.WriteLine(e)
        status = 1
    End Try
End If
Environment.Exit(status)
End Sub

End Module

```

Note that the overall code layout is the same as for the server: we use the same Try and Catch blocks to deal with errors. The code in the Try block does the following:

1. As for the server, we initialize the Ice run time by calling `Ice.Util.initialize`.
2. The next step is to obtain a proxy for the remote printer. We create a proxy by calling `stringToProxy` on the communicator, with the string `"SimplePrinter:default -p 10000"`. Note that the string contains the object identity and the port number that were used by the server. (Obviously, hard-coding object identities and port numbers into our applications is a bad idea, but it will do for now; we will see more architecturally sound ways of doing this in Chapter 37.)
3. The proxy returned by `stringToProxy` is of type `Ice::ObjectPrx`, which is at the root of the inheritance tree for interfaces and classes. But to actually talk to our printer, we need a proxy for a `Printer` interface, not an `Object` inter-

face. To do this, we need to do a down-cast by calling `PrinterPrxHelper.CheckedCast`. A checked cast sends a message to the server, effectively asking “is this a proxy for a `Printer` interface?” If so, the call returns a proxy of type `Demo::Printer`; otherwise, if the proxy denotes an interface of some other type, the call returns null.

4. We test that the down-cast succeeded and, if not, throw an error message that terminates the client.
5. We now have a live proxy in our address space and can call the `printString` method, passing it the time-honored “Hello World!” string. The server prints that string on its terminal.

Compiling the client looks much the same as for the server:

```
$ vbc /reference:Icecs.dll /lib:$ICICLE_HOME/lib Client.vb \
generated/Printer.vb
```

Running Client and Server

To run client and server, we first start the server in a separate window:

```
$ ./server.exe
```

At this point, we won’t see anything because the server simply waits for a client to connect to it. We run the client in a different window:

```
$ ./client.exe
$
```

The client runs and exits without producing any output; however, in the server window, we see the “Hello World!” that is produced by the printer. To get rid of the server, we interrupt it on the command line for now. (We will see cleaner ways to terminate a server in Chapter 16.)

If anything goes wrong, the client will print an error message. For example, if we run the client without having first started the server, we get something like the following:

```
Ice.ConnectFailedException: Connect failed: connection refused
   at IceInternal.ProxyFactory.checkRetryAfterException(LocalException
ex, Int32 cnt)
   at Ice.ObjectPrxHelperBase.__handleException(LocalException ex,
Int32 cnt)
   at Ice.ObjectPrxHelperBase.ice_isA(String __id, Context __conte
```

```

xt)
  at Ice.ObjectPrxHelperBase.ice_isA(String __id)
  at Demo.PrinterPrxHelper.checkedCast(ObjectPrx b)
  at Client.Main(String[] args)

```

Note that, to successfully run client and server, the VB run time must be able to locate the `Icecs.dll` library. (Under Windows, the simplest way to ensure this is to copy the library into the current directory. Please consult the documentation for your VB run time to see how it locates libraries.)

3.7 Writing an Ice Application with Python

This section shows how to create an Ice application with Python.

Compiling a Slice Definition for Python

The first step in creating our Python application is to compile our Slice definition to generate Python proxies and skeletons. You can compile the definition as follows:⁹

```
$ slice2py Printer.ice
```

The `slice2py` compiler produces a single source file, `Printer_ice.py`, from this definition. The compiler also creates a Python package for the `Demo` module, resulting in a subdirectory named `Demo`. The exact contents of the source file do not concern us for now—it contains the generated code that corresponds to the `Printer` interface we defined in `Printer.ice`.

Writing a Server

To implement our `Printer` interface, we must create a servant class. By convention, servant classes use the name of their interface with an `I`-suffix, so our servant class is called `PrinterI`:

```

class PrinterI(Demo.Printer):
    def printString(self, s, current=None):
        print s

```

9. Whenever we show UNIX commands in this book, we assume a Bourne or Bash shell. The commands for Windows are essentially identical and therefore not shown.

The `PrinterI` class inherits from a base class called `Demo.Printer`, which is generated by the `slice2py` compiler. The base class is abstract and contains a `printString` method that accepts a string for the printer to print and a parameter of type `Ice.Current`. (For now we will ignore the `Ice.Current` parameter. We will see its purpose in detail in Section 31.6.) Our implementation of the `printString` method simply writes its argument to the terminal.

The remainder of the server code, in `Server.py`, follows our servant class and is shown in full here:

```
import sys, traceback, Ice
import Demo

class PrinterI(Demo.Printer):
    def printString(self, s, current=None):
        print s

status = 0
ic = None
try:
    ic = Ice.initialize(sys.argv)
    adapter = ic.createObjectAdapterWithEndpoints(
        "SimplePrinterAdapter", "default -p 10000")
    object = PrinterI()
    adapter.add(object, Ice.stringToIdentity("SimplePrinter"))
    adapter.activate()
    ic.waitForShutdown()
except:
    traceback.print_exc()
    status = 1

if ic:
    # Clean up
    try:
        ic.destroy()
    except:
        traceback.print_exc()
        status = 1

sys.exit(status)
```

Note the general structure of the code:

```
status = 0
ic = None
try:

    # Server implementation here...

except:
    traceback.print_exc()
    status = 1

if ic:
    # Clean up
    try:
        ic.destroy()
    except:
        traceback.print_exc()
        status = 1

sys.exit(status)
```

The body of the main program contains a `try` block in which we place all the server code, followed by an `except` block. The `except` block catches all exceptions that may be thrown by the code; the intent is that, if the code encounters an unexpected run-time exception anywhere, the stack is unwound all the way back to the main program, which prints the exception and then returns failure to the operating system.

Before the code exits, it destroys the communicator (if one was created successfully). Doing this is essential in order to correctly finalize the Ice run time: the program *must* call `destroy` on any communicator it has created; otherwise, undefined behavior results.

The body of our `try` block contains the actual server code:

```
ic = Ice.initialize(sys.argv)
adapter = ic.createObjectAdapterWithEndpoints(
    "SimplePrinterAdapter", "default -p 10000")
object = PrinterI()
adapter.add(object, Ice.stringToIdentity("SimplePrinter"))
adapter.activate()
ic.waitForShutdown()
```

The code goes through the following steps:

1. We initialize the Ice run time by calling `Ice.initialize`. (We pass `sys.argv` to this call because the server may have command-line arguments that are of interest to the run time; for this example, the server does not require

- any command-line arguments.) The call to `initialize` returns an `Ice::Communicator` reference, which is the main handle to the Ice run time.
2. We create an object adapter by calling `createObjectAdapterWithEndpoints` on the `Communicator` instance. The arguments we pass are `"SimplePrinterAdapter"` (which is the name of the adapter) and `"default -p 10000"`, which instructs the adapter to listen for incoming requests using the default protocol (TCP/IP) at port number 10000.
 3. At this point, the server-side run time is initialized and we create a servant for our `Printer` interface by instantiating a `PrinterI` object.
 4. We inform the object adapter of the presence of a new servant by calling `add` on the adapter; the arguments to `add` are the servant we have just instantiated, plus an identifier. In this case, the string `"SimplePrinter"` is the name of the servant. (If we had multiple printers, each would have a different name or, more correctly, a different *object identity*.)
 5. Next, we activate the adapter by calling its `activate` method. (The adapter is initially created in a holding state; this is useful if we have many servants that share the same adapter and do not want requests to be processed until after all the servants have been instantiated.)
 6. Finally, we call `waitForShutdown`. This call suspends the calling thread until the server implementation terminates, either by making a call to shut down the run time, or in response to a signal. (For now, we will simply interrupt the server on the command line when we no longer need it.)

Note that, even though there is quite a bit of code here, that code is essentially the same for all servers. You can put that code into a helper class and, thereafter, will not have to bother with it again. (Ice ships with such a helper class, called `Ice.Application`—see Section 24.3.1.) As far as actual application code is concerned, the server contains only a few lines: three lines for the definition of the `PrinterI` class, plus two lines to instantiate a `PrinterI` object and register it with the object adapter.

Writing a Client

The client code, in `Client.py`, looks very similar to the server. Here it is in full:

```
import sys, traceback, Ice
import Demo

status = 0
ic = None
```

```
try:
    ic = Ice.initialize(sys.argv)
    base = ic.stringToProxy("SimplePrinter:default -p 10000")
    printer = Demo.PrinterPrx.checkedCast(base)
    if not printer:
        raise RuntimeError("Invalid proxy")

    printer.printString("Hello World!")
except:
    traceback.print_exc()
    status = 1

if ic:
    # Clean up
    try:
        ic.destroy()
    except:
        traceback.print_exc()
        status = 1

sys.exit(status)
```

Note that the overall code layout is the same as for the server: we use the same `try` and `except` blocks to deal with errors. The code in the `try` block does the following:

1. As for the server, we initialize the Ice run time by calling `Ice.initialize`.
2. The next step is to obtain a proxy for the remote printer. We create a proxy by calling `stringToProxy` on the communicator, with the string `"SimplePrinter:default -p 10000"`. Note that the string contains the object identity and the port number that were used by the server. (Obviously, hard-coding object identities and port numbers into our applications is a bad idea, but it will do for now; we will see more architecturally sound ways of doing this in Chapter 37.)
3. The proxy returned by `stringToProxy` is of type `Ice::ObjectPrx`, which is at the root of the inheritance tree for interfaces and classes. But to actually talk to our printer, we need a proxy for a `Demo::Printer` interface, not an `Object` interface. To do this, we need to do a down-cast by calling `Demo.PrinterPrx.checkedCast`. A checked cast sends a message to the server, effectively asking “is this a proxy for a `Demo::Printer` interface?” If so, the call returns a proxy of type `Demo.PrinterPrx`; otherwise, if the proxy denotes an interface of some other type, the call returns `None`.

4. We test that the down-cast succeeded and, if not, throw an error message that terminates the client.
5. We now have a live proxy in our address space and can call the `printString` method, passing it the time-honored "Hello World!" string. The server prints that string on its terminal.

Running Client and Server

To run client and server, we first start the server in a separate window:

```
$ python Server.py
```

At this point, we won't see anything because the server simply waits for a client to connect to it. We run the client in a different window:

```
$ python Client.py
$
```

The client runs and exits without producing any output; however, in the server window, we see the "Hello World!" that is produced by the printer. To get rid of the server, we interrupt it on the command line for now. (We will see cleaner ways to terminate a server in Chapter 24.)

If anything goes wrong, the client will print an error message. For example, if we run the client without having first started the server, we get something like the following:

```
Traceback (most recent call last):
  File "Client.py", line 10, in ?
    printer = Demo.PrinterPrx.checkedCast(base)
  File "Printer_ice.py", line 43, in checkedCast
    return Demo.PrinterPrx.ice_checkedCast(proxy, '::Demo::Printer', facet)
ConnectionRefusedException: Ice.ConnectionRefusedException:
Connection refused
```

Note that, to successfully run the client and server, the Python interpreter must be able to locate the Ice extension for Python. See the Ice for Python installation instructions for more information.

3.8 Writing an Ice Application with Ruby

This section shows how to create an Ice client application with Ruby.

Compiling a Slice Definition for Ruby

The first step in creating our Ruby application is to compile our Slice definition to generate Ruby proxies. You can compile the definition as follows:¹⁰

```
$ slice2rb Printer.ice
```

The `slice2rb` compiler produces a single source file, `Printer.rb`, from this definition. The exact contents of the source file do not concern us for now—it contains the generated code that corresponds to the `Printer` interface we defined in `Printer.ice`.

Writing a Client

The client code, in `Client.rb`, is shown below in full:

```
require 'Printer.rb'

status = 0
ic = nil
begin
  ic = Ice::initialize(ARGV)
  base = ic.stringToProxy("SimplePrinter:default -p 10000")
  printer = Demo::PrinterPrx::checkedCast(base)
  if not printer
    raise "Invalid proxy"
  end

  printer.printString("Hello World!")
rescue
  puts $!
  puts $!.backtrace.join("\n")
  status = 1
end

if ic
  # Clean up
  begin
    ic.destroy()
  rescue
    puts $!
    puts $!.backtrace.join("\n")
  end
end
```

10. Whenever we show UNIX commands in this book, we assume a Bourne or Bash shell. The commands for Windows are essentially identical and therefore not shown.

```
        status = 1
    end
end

exit(status)
```

The program begins with a `require` statement, which loads the Ruby code we generated from our `Slice` definition in the previous section. It is not necessary for the client to explicitly load the `Ice` module because `Printer.rb` already does that.

The body of the main program contains a `begin` block in which we place all the client code, followed by a `rescue` block. The `rescue` block catches all exceptions that may be thrown by the code; the intent is that, if the code encounters an unexpected run-time exception anywhere, the stack is unwound all the way back to the main program, which prints the exception and then returns failure to the operating system.

The body of our `begin` block goes through the following steps:

1. We initialize the Ice run time by calling `Ice::initialize`. (We pass `ARGV` to this call because the client may have command-line arguments that are of interest to the run time; for this example, the client does not require any command-line arguments.) The call to `initialize` returns an `Ice::Communicator` reference, which is the main handle to the Ice run time.
2. The next step is to obtain a proxy for the remote printer. We create a proxy by calling `stringToProxy` on the communicator, with the string `"SimplePrinter:default -p 10000"`. Note that the string contains the object identity and the port number that were used by the server. (Obviously, hard-coding object identities and port numbers into our applications is a bad idea, but it will do for now; we will see more architecturally sound ways of doing this in Chapter 37.)
3. The proxy returned by `stringToProxy` is of type `Ice::ObjectPrx`, which is at the root of the inheritance tree for interfaces and classes. But to actually talk to our printer, we need a proxy for a `Demo::Printer` interface, not an `Object` interface. To do this, we need to do a down-cast by calling `Demo::PrinterPrx::checkedCast`. A checked cast sends a message to the server, effectively asking “is this a proxy for a `Demo::Printer` interface?” If so, the call returns a proxy of type `Demo::PrinterPrx`; otherwise, if the proxy denotes an interface of some other type, the call returns `nil`.
4. We test that the down-cast succeeded and, if not, throw an error message that terminates the client.

5. We now have a live proxy in our address space and can call the `print-String` method, passing it the time-honored "Hello World!" string. The server prints that string on its terminal.

Before the code exits, it destroys the communicator (if one was created successfully). Doing this is essential in order to correctly finalize the Ice run time: the program *must* call `destroy` on any communicator it has created; otherwise, undefined behavior results.

Running the Client

The server must be started before the client. Since Ice for Ruby does not support server-side behavior, we need to use a server from another language mapping. In this case, we will use the C++ server:

```
$ server
```

At this point, we won't see anything because the server simply waits for a client to connect to it. We run the client in a different window:

```
$ ruby Client.rb
$
```

The client runs and exits without producing any output; however, in the server window, we see the "Hello World!" that is produced by the printer. To get rid of the server, we interrupt it on the command line for now. (We will see cleaner ways to terminate a server in Chapter 24.)

If anything goes wrong, the client will print an error message. For example, if we run the client without having first started the server, we get something like the following:

```
Ice::ConnectionRefusedException
(eval):46:in `ice_checkedCast'
(eval):46:in `checkedCast'
Client.rb:8
```

Note that, to successfully run the client, the Ruby interpreter must be able to locate the Ice extension for Ruby. See the Ice for Ruby installation instructions for more information.

3.9 Summary

This chapter presented a very simple (but complete) client and server. As we saw, writing an Ice application involves the following steps:

1. Write a Slice definition and compile it.
2. Write a server and compile it.
3. Write a client and compile it.

If someone else has written the server already and you are only writing a client, you do not need to write the Slice definition, only compile it (and, obviously, you do not need to write the server in that case).

Do not be concerned if, at this point, much appears unclear. The intent of this chapter is to give you an idea of the development process, not to explain the Ice APIs in intricate detail. We will cover all the detail throughout the remainder of this book.

Part II

Slice

Chapter 4

The Slice Language

4.1 Chapter Overview

In this chapter we present the Slice language. We start by discussing the role and purpose of Slice, explaining how language-independent specifications are compiled for particular implementation languages to create actual implementations. Sections 4.10 and 4.11 cover the core Slice concepts of interfaces, operations, exceptions, and inheritance. These concepts have profound influence on the behavior of a distributed system and should be read in detail.

This chapter also presents `slice2docbook`, which you can use to automate generation of documentation for Slice definitions.

4.2 Introduction

Slice¹ (Specification Language for Ice) is the fundamental abstraction mechanism for separating object interfaces from their implementations. Slice establishes a contract between client and server that describes the types and object interfaces used by an application. This description is independent of the implementation

1. Even though Slice is an acronym, it is pronounced as single syllable, like a slice of bread.

language, so it does not matter whether the client is written in the same language as the server.

Slice definitions are compiled for a particular implementation language by a compiler. The compiler translates the language-independent definitions into language-specific type definitions and APIs. These types and APIs are used by the developer to provide application functionality and to interact with Ice. The translation algorithms for various implementation languages are known as *language mappings*. Currently, Ice defines language mappings for C++, Java, C#, Visual Basic .NET, Python, Ruby, and PHP.

Because Slice describes interfaces and types (but not implementations), it is a purely declarative language; there is no way to write executable statements in Slice.

Slice definitions focus on object interfaces, the operations supported by those interfaces, and exceptions that may be raised by operations. In addition, Slice offers features for object persistence (see Chapter 38). This requires quite a bit of supporting machinery; in particular, quite a bit of Slice is concerned with the definition of data types. This is because data can be exchanged between client and server only if their types are defined in Slice. You cannot exchange arbitrary C++ data between client and server because it would destroy the language independence of Ice. However, you can always create a Slice type definition that corresponds to the C++ data you want to send, and then you can transmit the Slice type.

We present the full syntax and semantics of Slice here. Because much of Slice is based on C++ and Java, we focus on those areas where Slice differs from C++ or Java or constrains the equivalent C++ or Java feature in some way. Slice features that are identical to C++ and Java are mentioned mostly by example.

4.3 Compilation

A Slice compiler produces source files that must be combined with application code to produce client and server executables.

The outcome of the development process is a client executable and a server executable. These executables can be deployed anywhere, whether the target environments use the same or different operating systems and whether the executables are implemented using the same or different languages. The only constraint is that the host machines must provide the necessary run-time environment, such as any required dynamic libraries, and that connectivity can be established between them.

4.3.1 Single Development Environment for Client and Server

Figure 4.1 shows the situation when both client and server are developed in C++. The Slice compiler generates two files from a Slice definition in a source file `Printer.ice`: a header file (`Printer.h`) and a source file (`Printer.cpp`).

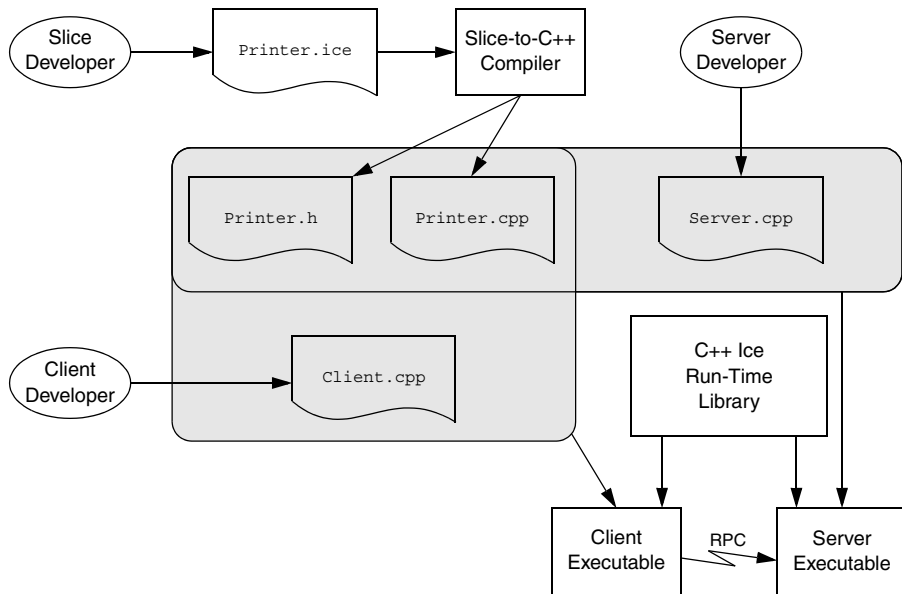

Figure 4.1. Development process if client and server share the same development environment.

- The `Printer.h` header file contains definitions that correspond to the types used in the Slice definition. It is included in the source code of both client and server to ensure that client and server agree about the types and interfaces used by the application.
- The `Printer.cpp` source file provides an API to the client for sending messages to remote objects. The client source code (`Client.cpp`, written by the client developer) contains the client-side application logic. The generated source code and the client code are compiled and linked into the client executable.

The `Printer.cpp` source file also contains source code that provides an up-call interface from the Ice run time into the server code written by the developer and provides the connection between the networking layer of Ice and the

application code. The server implementation file (`Server.cpp`, written by the server developer) contains the server-side application logic (the object implementations, properly termed *servants*). The generated source code and the implementation source code are compiled and linked into the server executable.

Both client and server also link with an Ice library that provides the necessary runtime support.

You are not limited to a single implementation of a client or server. For example, you can build multiple servers, each of which implements the same interfaces but uses different implementations (for example, with different performance characteristics). Multiple such server implementations can coexist in the same system. This arrangement provides one fundamental scalability mechanism in Ice: if you find that a server process starts to bog down as the number of objects increases, you can run an additional server for the same interfaces on a different machine. Such *federated* servers provide a single logical service that is distributed over a number of processes on different machines. Each server in the federation implements the same interfaces but hosts different object instances. (Of course, federated servers must somehow ensure consistency of any databases they share across the federation.)

Ice also provides support for *replicated* servers. Replication permits multiple servers to each implement the same set of object instances. This improves performance and scalability (because client load can be shared over a number of servers) as well as redundancy (because each object is implemented in more than one server).

4.3.2 Different Development Environments for Client and Server

Client and server cannot share any source or binary components if they are developed in different languages. For example, a client written in Java cannot include a C++ header file.

Figure 4.2 shows the situation when a client written in Java and the corresponding server is written in C++. In this case, the client and server developers are completely independent, and each uses his or her own development environment

and language mapping. The only link between client and server developers is the Slice definition each one uses.

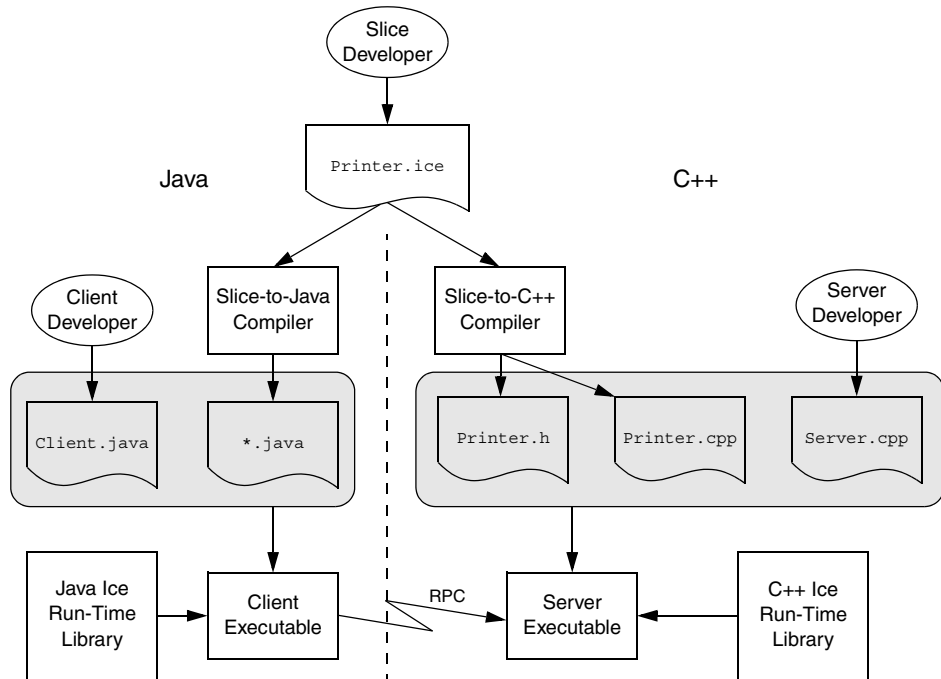

Figure 4.2. Development process for different development environments.

For Java, the slice compiler creates a number of files whose names depend on the names of various Slice constructs. (These files are collectively referred to as ***.java** in Figure 4.2.)

4.4 Source Files

Slice defines a number of rules for the naming and contents of Slice source files.

4.4.1 File Naming

Files containing Slice definitions must end in a `.ice` file extension, for example, `Clock.ice` is a valid file name. Other file extensions are rejected by the compilers.

For case-insensitive file systems (such as DOS), the file extension may be written as uppercase or lowercase, so `Clock.ICE` is legal. For case-sensitive file systems (such as UNIX), `Clock.ICE` is illegal. (The extension must be in lowercase.)

4.4.2 File Format

Slice is a free-form language so you can use spaces, horizontal and vertical tab stops, form feeds, and newline characters to lay out your code in any way you wish. (White space characters are token separators). Slice does not attach semantics to the layout of a definition. You may wish to follow the style we have used for the Slice examples throughout this book.

4.4.3 Preprocessing

Slice is preprocessed by the C++ preprocessor, so you can use the usual preprocessor directives, such as `#include` and macro definitions. However, Slice permits `#include` directives only at the beginning of a file, before any Slice definitions.

If you use a `#include` directive it is a good idea to protect them with guard to prevent double inclusion of a file:

```
// File Clock.ice
#ifndef _CLOCK_ICE
#define _CLOCK_ICE

// #include directives here...
// Definitions here...

#endif _CLOCK_ICE
```

`#include` directives permit a Slice definition to use types defined in a different source file. The Slice compilers parse all of the code in a source file, including the code in `#included` files. However, the compilers generate code only for the top-level file(s) nominated on the command line. You must separately compile `#included` files to obtain generated code for all the files that make up your Slice definition.

4.4.4 Definition Order

Slice constructs, such as modules, interfaces, or type definitions, can appear in any order you prefer. However, identifiers must be declared before they can be used.

4.5 Lexical Rules

Slice's lexical rules are very similar to those of C++ and Java, except for some differences for identifiers.

4.5.1 Comments

Slice definitions permit both the C and the C++ style of writing comments:

```
/*  
 * C-style comment.  
*/  
  
// C++-style comment extending to the end of this line.
```

4.5.2 Keywords

Slice uses a number of keywords, which must be spelled in lowercase. For example, `class` and `dictionary` are keywords and must be spelled as shown. There are two exceptions to this lowercase rule: `Object` and `LocalObject` are keywords and must be capitalized as shown. You can find a full list of Slice keywords in Appendix A.

4.5.3 Identifiers

Identifiers begin with an alphabetic character followed by any number of alphabetic characters or digits. Slice identifiers are restricted to the ASCII range of alphabetic characters and cannot contain non-English letters, such as Å. (Supporting non-ASCII identifiers would make it very difficult to map Slice to target languages that lack support for this feature.)

Unlike C++ identifiers, Slice identifiers cannot contain underscores. This restriction may seem draconian at first but is necessary: by reserving underscores, the various language mappings gain a namespace that cannot clash with legitimate Slice identifiers. That namespace can then be used to hold language-native identi-

fiers that are derived from Slice identifiers without fear of clashing with another, legitimate Slice identifier that happens to be the same as one of the derived identifiers.

Case Sensitivity

Identifiers are case-insensitive but must be capitalized consistently. For example, `TimeOfDay` and `TIMEOFDAY` are considered the same identifier within a naming scope. However, Slice enforces consistent capitalization. After you have introduced an identifier, you must capitalize it consistently throughout; otherwise, the compiler will reject it as illegal. This rule exists to permit mappings of Slice to languages that ignore case in identifiers as well as to languages that treat differently capitalized identifiers as distinct.

Identifiers That Are Keywords

You can define Slice identifiers that are keywords in one or more implementation languages. For example, `switch` is a perfectly good Slice identifier but is a C++ and Java keyword. Each language mapping defines rules for dealing with such identifiers. The solution typically involves using a prefix to map away from the keyword. For example, the Slice identifier `switch` is mapped to `_cpp_switch` in C++ and `_switch` in Java.

The rules for dealing with keywords can result in hard-to-read source code. Identifiers such as `native`, `throw`, or `export` will clash with C++ or Java keywords (or both). To make life easier for yourself and others, try to avoid Slice identifiers that are implementation language keywords. Keep in mind that mappings for new languages may be added to Ice in the future. While it is not reasonable to expect you to compile a list of all keywords in all popular programming languages, you should make an attempt to avoid at least common keywords. Slice identifiers such as `self`, `import`, and `while` are definitely not a good idea.

Escaped Identifiers

It is possible to use a Slice keyword as an identifier by prefixing the keyword with a backslash, for example:

```
struct dictionary {      // Error!
    // ...
};

struct \dictionary {    // OK
    // ...
};
```

```
struct \foo {           // Legal, same as "struct foo"  
    // ...  
};
```

The backslash escapes the usual meaning of a keyword; in the preceding example, `\dictionary` is treated as the identifier `dictionary`. The escape mechanism exists to permit keywords to be added to the Slice language over time with minimal disruption to existing specifications: if a pre-existing specification happens to use a newly-introduced keyword, that specification can be fixed by simply prepending a backslash to the new keyword. Note that, as a matter of style, you should avoid using Slice keywords as identifiers (even though the backslash escapes allow you to do this).

It is legal (though redundant) to precede an identifier that is not a keyword with a backslash—the backslash is ignored in that case.

Reserved Identifiers

Slice reserves the identifier `Ice` and all identifiers beginning with `Ice` (in any capitalization) for the `Ice` implementation. For example, if you try to define a type named `Icecream`, the Slice compiler will issue an error message.²

Slice identifiers ending in any of the suffixes `Helper`, `Holder`, `Prx`, and `Ptr` are also reserved. These endings are used by the various language mappings and are reserved to prevent name clashes in the generated code.

4.6 Modules

A common problem in large systems is pollution of the global namespace: over time, as isolated systems are integrated, name clashes become quite likely. Slice provides the `module` construct to alleviate this problem:

```
module ZeroC {  
    module Client {  
        // Definitions here...  
    };  
};
```

2. You can suppress this behavior by using the `--ice` compiler option, which enables definition of identifiers beginning with `Ice`. However, do not use this option unless you are compiling the Slice definitions for the `Ice` run time itself.

```
    module Server {
        // Definitions here...
    };
};
```

A module can contain any legal Slice construct, including other module definitions. Using modules to group related definitions together avoids polluting the global namespace and makes accidental name clashes quite unlikely. (You can use a well-known name, such as a company or product name, as the name of the outermost module.)

Slice requires all definitions to be nested inside a module, that is, you cannot define anything other than a module at global scope. For example, the following is illegal:

```
interface I { // Error: only modules can appear at global scope
    // ...
};
```

Definitions at global scope are prohibited because they cause problems with some implementation languages (such as Python, which does not have a true global scope).

NOTE: Throughout the remainder of this book, you will occasionally see Slice definitions that are not nested inside a module. This is to keep the examples short and free of clutter. Whenever you see such a definition, assume that it is nested in a module.

Modules can be reopened:

```
module ZeroC {
    // Definitions here...
};

// Possibly in a different source file:

module ZeroC { // OK, reopened module
    // More definitions here...
};
```

Reopened modules are useful for larger projects: they allow you to split the contents of a module over several different source files. The advantage of doing this is that, when a developer makes a change to one part of the module, only files dependent on the changed part need be recompiled (instead of having to recompile all files that use the module).

Modules map to a corresponding scoping construct in each programming language. (For example, for C++, C#, and Visual Basic, Slice modules map to namespaces and, for Java, they map to packages.) This allows you to use an appropriate C++ `using` or Java `import` declaration to avoid excessively long identifiers in the source code.

4.7 The Ice Module

APIs for the Ice run time, apart from a small number of language-specific calls that cannot be expressed in Ice, are defined in the Ice module. In other words, most of the Ice API is actually expressed as Slice definitions. The advantage of doing this is that a single Slice definition is sufficient to define the API for the Ice run time for all supported languages. The respective language mapping rules then determine the exact shape of each Ice API for each implementation language.

We will incrementally explore the contents of the Ice module throughout the remainder of this book.

4.8 Basic Slice Types

Slice provides a number of built-in basic types, shown in Table 4.1.

Table 4.1. Slice basic types.

Type	Range of Mapped Type	Size of Mapped Type
<code>bool</code>	<code>false</code> or <code>true</code>	≥ 1bit
<code>byte</code>	-128-127 ^a	≥ 8 bits
<code>short</code>	-2 ¹⁵ to 2 ¹⁵ -1	≥ 16 bits
<code>int</code>	-2 ³¹ to 2 ³¹ -1	≥ 32 bits
<code>long</code>	-2 ⁶³ to 2 ⁶³ -1	≥ 64 bits
<code>float</code>	IEEE single-precision	≥ 32 bits
<code>double</code>	IEEE double-precision	≥ 64 bits
<code>string</code>	All Unicode characters, excluding the character with all bits zero.	Variable-length

a. Or 0-255, depending on the language mapping

All the basic types (except `byte`) are subject to changes in representation as they are transmitted between clients and servers. For example, a `long` value is byte-swapped when sent from a little-endian to a big-endian machine. Similarly, strings undergo translation in representation if they are sent, for example, from an EBCDIC to an ASCII implementation, and the characters of a string may also change in size. (Not all architectures use 8-bit characters). However, these changes are transparent to the programmer and do exactly what is required.

4.8.1 Integer Types

Slice provides integer types `short`, `int`, and `long`, with 16-bit, 32-bit, and 64-bit ranges, respectively. Note that, on some architectures, any of these types may be mapped to a native type that is wider. Also note that no unsigned types are provided. (This choice was made because unsigned types are difficult to map into languages without native unsigned types, such as Java. In addition, the unsigned integers add little value to a language. See [9] for a good treatment of the topic.)

4.8.2 Floating-Point Types

These types follow the IEEE specification for single- and double-precision floating-point representation [6]. If an implementation cannot support IEEE format floating-point values, the Ice run time converts values into the native floating-point representation (possibly at a loss of precision or even magnitude, depending on the capabilities of the native floating-point format).

4.8.3 Strings

Slice strings use the Unicode character set. The only character that cannot appear inside a string is the zero character.³

The Slice data model does *not* have the concept of a null string (in the sense of a C++ null pointer). This decision was made because null strings are difficult to map to languages without direct support for this concept (such as Python). Do not design interfaces that depend on a null string to indicate “not there” semantics. If you need the notion of an optional string, use a class (see Section 4.11), a sequence of strings (see Section 4.9.3), or use an empty string to represent the idea of a null string. (Of course, the latter assumes that the empty string is not otherwise used as a legitimate string value by your application.)

4.8.4 Booleans

Boolean values can have only the values `false` and `true`. Language mappings use the corresponding native boolean type if one is available.

4.8.5 Bytes

The Slice type `byte` is an (at least) 8-bit type that is guaranteed not to undergo any changes in representation as it is transmitted between address spaces. This guarantee permits exchange of binary data such that it is not tampered with in transit. All other Slice types are subject to changes in representation during transmission.

3. This decision was made as a concession to C++, with which it becomes impossibly difficult to manipulate strings with embedded zero characters using standard library routines, such as `strlen` or `strcat`.

4.9 User-Defined Types

In addition to providing the built-in basic types, Slice allows you to define complex types: enumerations, structures, sequences, and dictionaries.

4.9.1 Enumerations

A Slice enumerated type definition looks like the C++ version:

```
enum Fruit { Apple, Pear, Orange };
```

This definition introduces a type named `Fruit` that becomes a new type in its own right. Slice does not define how ordinal values are assigned to enumerators. For example, you cannot assume that the enumerator `Orange` will have the value 2 in different implementation languages. Slice guarantees only that the ordinal values of enumerators increase from left to right, so `Apple` compares less than `Pear` in all implementation languages.

Unlike C++, Slice does not permit you to control the ordinal values of enumerators (because many implementation languages do not support such a feature):

```
enum Fruit { Apple = 0, Pear = 7, Orange = 2 }; // Syntax error
```

In practice, you do not care about the values used for enumerators as long as you do not transmit the *ordinal value* of an enumerator between address spaces. For example, sending the value 0 to a server to mean `Apple` can cause problems because the server may not use 0 to represent `Apple`. Instead, simply send the value `Apple` itself. If `Apple` is represented by a different ordinal value in the receiving address space, that value will be appropriately translated by the Ice runtime.

As with C++, Slice enumerators enter the enclosing namespace, so the following is illegal:

```
enum Fruit { Apple, Pear, Orange };  
enum ComputerBrands { Apple, IBM, Sun, HP }; // Apple redefined
```

Slice does not permit empty enumerations.

4.9.2 Structures

Slice supports structures containing one or more named members of arbitrary type, including user-defined complex types. For example:

```
struct TimeOfDay {
    short hour;           // 0 - 23
    short minute;        // 0 - 59
    short second;        // 0 - 59
};
```

As in C++, this definition introduces a new type called `TimeOfDay`. Structure definitions form a namespace, so the names of the structure members need to be unique only within their enclosing structure.

Data member definitions using a named type are the only construct that can appear inside a structure. It is impossible to, for example, define a structure inside a structure:

```
struct TwoPoints {
    struct Point {       // Illegal!
        short x;
        short y;
    };
    Point coord1;
    Point coord2;
};
```

This rule applies to Slice in general: type definitions cannot be nested (except for modules, which do support nesting—see Section 4.6). The reason for this rule is that nested type definitions can be difficult to implement for some target languages and, even if implementable, greatly complicate the scope resolution rules. For a specification language, such as Slice, nested type definitions are unnecessary—you can always write the above definitions as follows (which is stylistically cleaner as well):

```
struct Point {
    short x;
    short y;
};

struct TwoPoints {      // Legal (and cleaner!)
    Point coord1;
    Point coord2;
};
```

4.9.3 Sequences

Sequences are variable-length vectors of elements:

```
sequence<Fruit> FruitPlatter;
```

A sequence can be empty—that is, it can contain no elements, or it can hold any number of elements up to the memory limits of your platform.

Sequences can contain elements that are themselves sequences. This arrangement allows you to create lists of lists:

```
sequence<FruitPlatter> FruitBanquet;
```

Sequences are used to model a variety of collections, such as vectors, lists, queues, sets, bags, or trees. (It is up to the application to decide whether or not order is important; by discarding order, a sequence serves as a set or bag.)

One particular use of sequences has become idiomatic, namely, the use of a sequence to indicate an optional value. For example, we might have a `Part` structure that records the details of the parts that go into a car. The structure could record things such as the name of the part, a description, weight, price, and other details. Spare parts commonly have a serial number, which we can model as a `long` value. However, some parts, such as simple screws, often do not have a serial number, so what are we supposed to put into the serial number field of a screw? There are a number of options for dealing with this situation:

- Use a sentinel value, such as zero, to indicate the “no serial” number condition.

This approach is workable, provided that a sentinel value is actually available. While it may seem unlikely that anyone would use a serial number of zero for a part, it is not impossible. And, for other values, such as a temperature value, all values in the range of their type can be legal, so no sentinel value is available.

- Change the type of the serial number from `long` to `string`.

Strings come with their own built-in sentinel value, namely, the empty string so we can use an empty string to indicate the “no serial number” case. This is workable, but leaves a bad taste in most people’s mouth: we should not have to change the natural data type of something to `string` just so we get a sentinel value.

- Add an indicator as to whether the contents of the serial number are valid:

```
struct Part {
    string name;
    string description;
    // ...
    bool   serialIsValid; // true if part has serial number
    long   serialNumber;
};
```

This is distasteful to most people and guaranteed to get you into trouble eventually: sooner or later, some programmer will forget to check whether the serial number is valid before using it and create havoc.

- Use a sequence to model the optional field.

This technique uses the following convention:

```
sequence<long> SerialOpt;
```

```
struct Part {
    string   name;
    string   description;
    // ...
    SerialOpt serialNumber; // optional: zero or one element
};
```

By convention, the `Opt` suffix is used to indicate that the sequence is used to model an optional value. If the sequence is empty, the value is obviously not there; if it contains a single element, that element is the value. The obvious drawback of this scheme is that someone could put more than one element into the sequence. This could be rectified by adding a special-purpose `Slice` construct for optional values. However, optional values are not used frequently enough to justify the complexity of adding a dedicated language feature. (As we will see in Section 4.11, you can also use class hierarchies to model optional fields.)

4.9.4 Dictionaries

A dictionary is a mapping from a key type to a value type. For example:

```
struct Employee {
    long number;
    string firstName;
    string lastName;
};
```

```
dictionary<long, Employee> EmployeeMap;
```

This definition creates a dictionary named `EmployeeMap` that maps from an employee number to a structure containing the details for an employee. Whether or not the key type (the employee number, of type `long` in this example) is also part of the value type (the `Employee` structure in this example) is up to you—as far as Slice is concerned, there is no need to include the key as part of the value.

Dictionaries can be used to implement sparse arrays, or any lookup data structure with non-integral key type. Even though a sequence of structures containing key–value pairs could be used to model the same thing, a dictionary is more appropriate:

- A dictionary clearly signals the intent of the designer, namely, to provide a mapping from a domain of values to a range of values. (A sequence of structures of key–value pairs does not signal that same intent as clearly.)
- At the programming language level, sequences are implemented as vectors (or possibly lists), that is, they are not well suited to model sparsely populated domains and require a linear search to locate an element with a particular value. On the other hand, dictionaries are implemented as a data structure (typically a hash table or red-black tree) that supports efficient searching in $O(\log n)$ average time or better.

The key type of a dictionary need not be an integral type. For example, we could use the following definition to translate the names of the days of the week:

```
dictionary<string, string> WeekdaysEnglishToGerman;
```

The server implementation would take care of initializing this map with the key–value pairs `Monday–Montag`, `Tuesday–Dienstag`, and so on.

The value type of a dictionary can be any user-defined type. However, the key type of a dictionary is limited to one of the following types:

- Integral types (`byte`, `short`, `int`, `long`, `bool`, and enumerated types)
- `string`
- sequences with elements of integral type or `string`
- structures containing only data members of integral type or `string`

Complex nested types, such as nested structures or dictionaries, and floating-point types (`float` and `double`) cannot be used as the key type. Complex nested types are disallowed because they complicate the language mappings for dictionaries, and floating-point types are disallowed because representational changes of values as they cross machine boundaries can lead to ill-defined semantics for equality.

4.9.5 Constant Definitions and Literals

Slice allows you to define constants. Constant definitions must be of one of the following types:

- An integral type (`bool`, `byte`, `short`, `int`, `long`, or an enumerated type)
- `float` or `double`
- `string`

Here are a few examples:

```
const bool      AppendByDefault = true;
const byte      LowerNibble = 0x0f;
const string    Advice = "Don't Panic!";
const short     TheAnswer = 42;
const double    PI = 3.1416;
```

```
enum Fruit { Apple, Pear, Orange };
const Fruit    FavoriteFruit = Pear;
```

The syntax for literals is the same as for C++ and Java (with a few minor exceptions):

- Boolean constants can only be initialized with the keywords `false` and `true`. (You cannot use `0` and `1` to represent `false` and `true`.)
- As for C++, integer literals can be specified in decimal, octal, or hexadecimal notation. For example:

```
const byte TheAnswer = 42;
const byte TheAnswerInOctal = 052;
const byte TheAnswerInHex = 0x2A;           // or 0x2a
```

Be aware that, if you interpret `byte` as a number instead of a bit pattern, you may get different results in different languages. For example, for C++, `byte` maps to `unsigned char` whereas, for Java, `byte` maps to `byte`, which is a signed type.

Note that suffixes to indicate long and unsigned constants (`l`, `L`, `u`, `U`, used by C++) are illegal:

```
const long Wrong = 0u;           // Syntax error
const long WrongToo = 1000000L; // Syntax error
```

The value of an integer literal must be within the range of its constant type, as shown in Table 4.1 on page 90; otherwise the compiler will issue a diagnostic.

- Floating-point literals use C++ syntax, except that you cannot use an `l` or `L` suffix to indicate an extended floating-point constant; however, `f` and `F` are legal (but are ignored). Here are a few examples:

```
const float P1 = -3.14f;      // Integer & fraction, with suffix
const float P2 = +3.1e-3;    // Integer, fraction, and exponent
const float P3 = .1;         // Fraction part only
const float P4 = 1.;         // Integer part only
const float P5 = .9E5;       // Fraction part and exponent
const float P6 = 5e2;        // Integer part and exponent
```

Floating-point literals must be within the range of the constant type (`float` or `double`); otherwise, the compiler will issue a diagnostic.

- String literals support the same escape sequences as C++. Here are some examples:

```
const string AnOrdinaryString = "Hello World!";

const string DoubleQuote =    "\"";
const string TwoSingleQuotes = "'\''"; // ' and \' are OK
const string Newline =       "\n";
const string CarriageReturn = "\r";
const string HorizontalTab = "\t";
const string VerticalTab =   "\v";
const string FormFeed =     "\f";
const string Alert =        "\a";
const string Backspace =    "\b";
const string QuestionMark = "\?";
const string Backslash =    "\\";

const string OctalEscape =    "\007"; // Same as \a
const string HexEscape =     "\x07"; // Ditto

const string UniversalCharName = "\u03A9"; // Greek Omega
```

As for C++, adjacent string literals are concatenated:

```
const string MSG1 = "Hello World!";
const string MSG2 = "Hello" " " "World!";           // Same message

/*
 * Escape sequences are processed before concatenation,
 * so the string below contains two characters,
 * '\xa' and 'c'.
 */

const string S = "\xa" "c";
```

Note that Slice has no concept of a null string:

```
const string nullString = 0;    // Illegal!
```

Null strings simply do not exist in Slice and, therefore, do not exist as a legal value for a string anywhere in the Ice platform. The reason for this decision is that null strings do not exist in many programming languages.⁴

4.10 Interfaces, Operations, and Exceptions

The central focus of Slice is on defining interfaces, for example:

```
struct TimeOfDay {
    short hour;           // 0 - 23
    short minute;       // 0 - 59
    short second;       // 0 - 59
};

interface Clock {
    TimeOfDay getTime();
    void setTime(TimeOfDay time);
};
```

This definition defines an interface type called `Clock`. The interface supports two operations: `getTime` and `setTime`. Clients access an object supporting the `Clock` interface by invoking an operation on the proxy for the object: to read the current time, the client invokes the `getTime` operation; to set the current time, the client invokes the `setTime` operation, passing an argument of type `TimeOfDay`.

4. Many languages other than C and C++ use a byte array as the internal string representation. Null strings do not exist (and would be very difficult to map) in such languages.

Invoking an operation on a proxy instructs the Ice run time to send a message to the target object. The target object can be in another address space or can be collocated (in the same process) as the caller—the location of the target object is transparent to the client. If the target object is in another (possibly remote) address space, the Ice run time invokes the operation via a remote procedure call; if the target is collocated with the client, the Ice run time uses an ordinary function call instead, to avoid the overhead of marshaling.

You can think of an interface definition as the equivalent of the public part of a C++ class definition or as the equivalent of a Java interface, and of operation definitions as (virtual) member functions. Note that nothing but operation definitions are allowed to appear inside an interface definition. In particular, you cannot define a type, an exception, or a data member inside an interface. This does not mean that your object implementation cannot contain state—it can, but how that state is implemented (in the form of data members or otherwise) is hidden from the client and, therefore, need not appear in the object’s interface definition.

An Ice object has exactly one (most derived) Slice interface type (or class type—see Section 4.11). Of course, you can create multiple Ice objects that have the same type; to draw the analogy with C++, a Slice interface corresponds to a C++ class *definition*, whereas an Ice object corresponds to a C++ class *instance* (but Ice objects can be implemented in multiple different address spaces).

Ice also provides multiple interfaces via a feature called *facets*. We discuss facets in detail in Chapter 33.

A Slice interface defines the smallest grain of distribution in Ice: each Ice object has a unique identity (encapsulated in its proxy) that distinguishes it from all other Ice objects; for communication to take place, you must invoke operations on an object’s proxy. There is no other notion of an addressable entity in Ice. You cannot, for example, instantiate a Slice structure and have clients manipulate that structure remotely. To make the structure accessible, you must create an interface that allows clients to access the structure.

The partition of an application into interfaces therefore has profound influence on the overall architecture. Distribution boundaries must follow interface (or class) boundaries; you can spread the implementation of interfaces over multiple address spaces (and you can implement multiple interfaces in the same address space), but you cannot implement parts of interfaces in different address spaces.

4.10.1 Parameters and Return Values

An operation definition must contain a return type and zero or more parameter definitions. For example, the `getTime` operation on page 99 has a return type of `TimeOfDay` and the `setTime` operation has a return type of `void`. You must use `void` to indicate that an operation returns no value—there is no default return type for Slice operations.

An operation can have one or more input parameters. For example, `setTime` accepts a single input parameter of type `TimeOfDay` called `time`. Of course, you can use multiple input parameters, for example:

```
interface CircadianRhythm {
    void setSleepPeriod(TimeOfDay startTime, TimeOfDay stopTime);
    // ...
};
```

Note that the parameter name (as for Java) is mandatory. You cannot omit the parameter name, so the following is in error:

```
interface CircadianRhythm {
    void setSleepPeriod(TimeOfDay, TimeOfDay); // Error!
    // ...
};
```

By default, parameters are sent from the client to the server, that is, they are input parameters. To pass a value from the server to the client, you can use an output parameter, indicated by the `out` keyword. For example, an alternative way to define the `getTime` operation on page 99 would be:

```
void getTime(out TimeOfDay time);
```

This achieves the same thing but uses an output parameter instead of the return value. As with input parameters, you can use multiple output parameters:

```
interface CircadianRhythm {
    void setSleepPeriod(TimeOfDay startTime, TimeOfDay stopTime);
    void getSleepPeriod(out TimeOfDay startTime,
                       out TimeOfDay stopTime);
    // ...
};
```

If you have both input and output parameters for an operation, the output parameters must follow the input parameters:

```

void changeSleepPeriod(   TimeOfDay startTime,    // OK
                        TimeOfDay stopTime,
                        out TimeOfDay prevStartTime,
                        out TimeOfDay prevStopTime);
void changeSleepPeriod(out TimeOfDay prevStartTime,
                        out TimeOfDay prevStopTime,
                        TimeOfDay startTime,    // Error
                        TimeOfDay stopTime);

```

Slice does not support parameters that are both input and output parameters (call by reference). The reason is that, for remote calls, reference parameters do not result in the same savings that one can obtain for call by reference in programming languages. (Data still needs to be copied in both directions and any gains in marshaling efficiency are negligible.) Also, reference (or input–output) parameters result in more complex language mappings, with concomitant increases in code size.

Style of Operation Definition

As you would expect, language mappings follow the style of operation definition you use in Slice: Slice return types map to programming language return types, and Slice parameters map to programming language parameters.

For operations that return only a single value, it is common to return the value from the operation instead of using an out-parameter. This style maps naturally into all programming languages. Note that, if you use an out-parameter instead, you impose a different API style on the client: most programming languages permit the return value of a function to be ignored whereas it is typically not possible to ignore an output parameter.

For operations that return multiple values, it is common to return all values as out-parameters and to use a return type of `void`. However, the rule is not all that clear-cut because operations with multiple output values can have one particular value that is considered more “important” than the remainder. A common example of this is an iterator operation that returns items from a collection one-by-one:

```
bool next(out RecordType r);
```

The `next` operation returns two values: the record that was retrieved and a Boolean to indicate the end-of-collection condition. (If the return value is `false`, the end of the collection has been reached and the parameter `r` has an undefined value.) This style of definition can be useful because it naturally fits into the way programmers write control structures. For example:

```

while (next(record))
    // Process record...

if (next(record))
    // Got a valid record...

```

Overloading

Slice does not support any form of overloading of operations. For example:

```

interface CircadianRhythm {
    void modify(TimeOfDay startTime,
               TimeOfDay endTime);
    void modify(    TimeOfDay startTime,          // Error
                  TimeOfDay endTime,
                  out TimeOfDay prevStartTime,
                  out TimeOfDay prevEndTime);
};

```

Operations in the same interface must have different names, regardless of what type and number of parameters they have. This restriction exists because overloaded functions cannot sensibly be mapped to languages without built-in support for overloading.⁵

Nonmutating Operations

Some operations, such as `getTime` on page 99, do not modify the state of the object they operate on. They are the conceptual equivalent of C++ `const` member functions. You can indicate this in Slice as follows:

```

interface Clock {
    nonmutating TimeOfDay getTime();
    void setTime(TimeOfDay time);
};

```

The `nonmutating` keyword indicates that the `getTime` operation does not change the state of its object. This is useful for two reasons:

- Language mappings can take advantage of the additional knowledge about the behavior of the operation. For example, for C++, `nonmutating` operations map to C++ `const` member functions on skeleton classes.

5. Name mangling is not an option in this case: while it works fine for compilers, it is unacceptable to humans.

- Knowing that an operation will not modify the state of its object permits the Ice run time to attempt more aggressive error recovery. Specifically, Ice guarantees *at-most-once* semantics for operation invocations.

For normal operations, the Ice run time has to be conservative about how it deals with errors. For example, if a client sends an operation invocation to a server and then loses connectivity, there is no way for the client-side run time to find out whether the request it sent actually made it to the server. This means that the run time cannot attempt to recover from the error by re-establishing a connection and sending the request a second time because that could cause the operation to be invoked a second time and violate *at-most-once* semantics; the run time has no option but to report the error to the application.

For `nonmutating` operations, on the other hand, the client-side run time can attempt to re-establish a connection to the server and safely send the failed request a second time. If the server can be reached on the second attempt, everything is fine and the application never notices the (temporary) failure. Only if the second attempt fails need the run time report the error back to the application. (The number of retries can be increased with an Ice configuration parameter.)

Idempotent Operations

We can further modify the definition of the `Clock` interface on page 103 to indicate that the `setTime` operation is *idempotent*:

```
interface Clock {
    nonmutating TimeOfDay getTime();
    idempotent void setTime(TimeOfDay time);
};
```

An operation is idempotent if two successive invocations of the operation have the same effect as a single invocation. For example, `x = 1;` is an idempotent operation because it does not matter whether it is executed once or twice—either way, `x` ends up with the value 1. On the other hand, `x += 1;` is not an idempotent operation because executing it twice results in a different value for `x` than executing it once.

The `idempotent` keyword indicates that an operation can safely be executed more than once. As for `nonmutating` operations, the Ice run time uses this knowledge to recover more aggressively from errors.

An operation can have either a `nonmutating` or an `idempotent` qualifier, but not both. (`nonmutating` implies `idempotent`.)

4.10.2 User Exceptions

Looking at the `setTime` operation on page 99, we find a potential problem: given that the `TimeOfDay` structure uses `short` as the type of each field, what will happen if a client invokes the `setTime` operation and passes a `TimeOfDay` value with meaningless field values, such as `-199` for the minute field, or `42` for the hour? Obviously, it would be nice to provide some indication to the caller that this is meaningless. Slice allows you to define user exceptions to indicate error conditions to the client. For example:

```
exception Error {}; // Empty exceptions are legal

exception RangeError {
    TimeOfDay errorTime;
    TimeOfDay minTime;
    TimeOfDay maxTime;
};
```

A user exception is much like a structure in that it contains a number of data members. However, unlike structures, exceptions can have zero data members, that is, be empty. Exceptions allow you to return an arbitrary amount of error information to the client if an error condition arises in the implementation of an operation. Operations use an exception specification to indicate the exceptions that may be returned to the client:

```
interface Clock {
    nonmutating TimeOfDay getTime();
    idempotent void setTime(TimeOfDay time)
        throws RangeError, Error;
};
```

This definition indicates that the `setTime` operation may throw either a `RangeError` or an `Error` user exception (and no other type of exception). If the client receives a `RangeError` exception, the exception contains the `TimeOfDay` value that was passed to `setTime` and caused the error (in the `errorTime` member), as well as the minimum and maximum time values that can be used (in the `minTime` and `maxTime` members). If `setTime` failed because of an error not caused by an illegal parameter value, it throws `Error`. Obviously, because `Error` does not have data members, the client will have no idea what exactly it was that went wrong—it simply knows that the operation did not work.

An operation can throw only those user exceptions that are listed in its exception specification. If, at run time, the implementation of an operation throws an exception that is not listed in its exception specification, the client receives a run-

time exception (see Section 4.10.4) to indicate that the operation did something illegal. To indicate that an operation does not throw any user exception, simply omit the exception specification. (There is no empty exception specification in Slice.)

Exceptions are not first-class data types and first-class data types are not exceptions:

- You cannot pass an exception as a parameter value.
- You cannot use an exception as the type of a data member.
- You cannot use an exception as the element type of a sequence.
- You cannot use an exception as the key or value type of a dictionary.
- You cannot throw a value of non-exception type (such as a value of type `int` or `string`).

The reason for these restrictions is that some implementation languages use a specific and separate type for exceptions (in the same way as Slice does). For such languages, it would be difficult to map exceptions if they could be used as an ordinary data type. (C++ is somewhat unusual among programming languages by allowing arbitrary types to be used as exceptions.)

4.10.3 Exception Inheritance

Exceptions support inheritance. For example:

```
exception ErrorBase {
    string reason;
};

enum RError {
    DivideByZero, NegativeRoot, IllegalNull /* ... */
};

exception RuntimeError extends ErrorBase {
    RError err;
};

enum LError { ValueOutOfRange, ValuesInconsistent, /* ... */ };

exception LogicError extends ErrorBase {
    LError err;
};

exception RangeError extends LogicError {
```



```
    TimeOfDay errorTime;  
    TimeOfDay minTime;  
    TimeOfDay maxTime;  
};
```

These definitions set up a simple exception hierarchy:

- `ErrorBase` is at the root of the tree and contains a string explaining the cause of the error.
- Derived from `ErrorBase` are `RuntimeError` and `LogicError`. Each of these exceptions contains an enumerated value that further categorizes the error.
- Finally, `RangeError` is derived from `LogicError` and reports the details of the specific error.

Setting up exception hierarchies such as this not only helps to create a more readable specification because errors are categorized, but also can be used at the language level to good advantage. For example, the Slice C++ mapping preserves the exception hierarchy so you can catch exceptions generically as a base exception, or set up exception handlers to deal with specific exceptions.

Looking at the exception hierarchy on page 106, it is not clear whether, at run time, the application will only throw most derived exceptions, such as `RangeError`, or if it will also throw base exceptions, such as `LogicError`, `RuntimeError`, and `ErrorBase`. If you want to indicate that a base exception, interface, or class is abstract (will not be instantiated), you can add a comment to that effect.

Note that, if the exception specification of an operation indicates a specific exception type, at run time, the implementation of the operation may also throw more derived exceptions. For example:

```
exception Base {  
    // ...  
};  
  
exception Derived extends Base {  
    // ...  
};  
  
interface Example {  
    void op() throws Base;    // May throw Base or Derived  
};
```

In this example, `op` may throw a `Base` or a `Derived` exception, that is, any exception that is compatible with the exception types listed in the exception specification can be thrown at run time.

As a system evolves, it is quite common for new, derived exceptions to be added to an existing hierarchy. Assume that we initially construct clients and server with the following definitions:

```
exception Error {
    // ...
};

interface Application {
    void doSomething() throws Error;
};
```

Also assume that a large number of clients are deployed in field, that is, when you upgrade the system, you cannot easily upgrade all the clients. As the application evolves, a new exception is added to the system and the server is redeployed with the new definition:

```
exception Error {
    // ...
};

exception FatalApplicationError extends Error {
    // ...
};

interface Application {
    void doSomething() throws Error;
};
```

This raises the question of what should happen if the server throws a `FatalApplicationError` from `doSomething`. The answer depends whether the client was built using the old or the updated definition:

- If the client was built using the same definition as the server, it simply receives a `FatalApplicationError`.
- If the client was built with the original definition, that client has no knowledge that `FatalApplicationError` even exists. In this case, the Ice run time automatically slices the exception to the most-derived type that is understood by the receiver (`Error`, in this case) and discards the information that is specific to the derived part of the exception. (This is exactly analogous to catching C++ exceptions by value—the exception is sliced to the type used in the `catch`-clause.)

Exceptions support single inheritance only. (Multiple inheritance would be difficult to map into many programming languages.)

4.10.4 Ice Run-Time Exceptions

As mentioned in Section 2.2.2, in addition to any user exceptions that are listed in an operation's exception specification, an operation can also throw Ice *run-time exceptions*. Run-time exceptions are predefined exceptions that indicate platform-related run-time errors. For example, if a networking error interrupts communication between client and server, the client is informed of this by a run-time exception, such as `ConnectTimeoutException` or `SocketException`.

The exception specification of an operation must not list any run-time exceptions. (It is understood that all operations can raise run-time exceptions and you are not allowed to restate that.)

Inheritance Hierarchy for Exceptions

All the Ice run-time and user exceptions are arranged in an inheritance hierarchy, as shown in Figure 4.3.

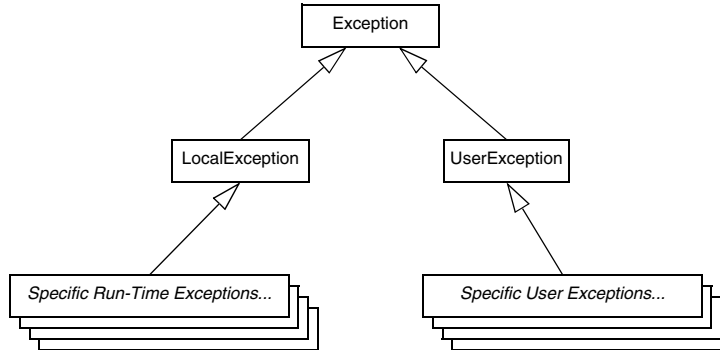
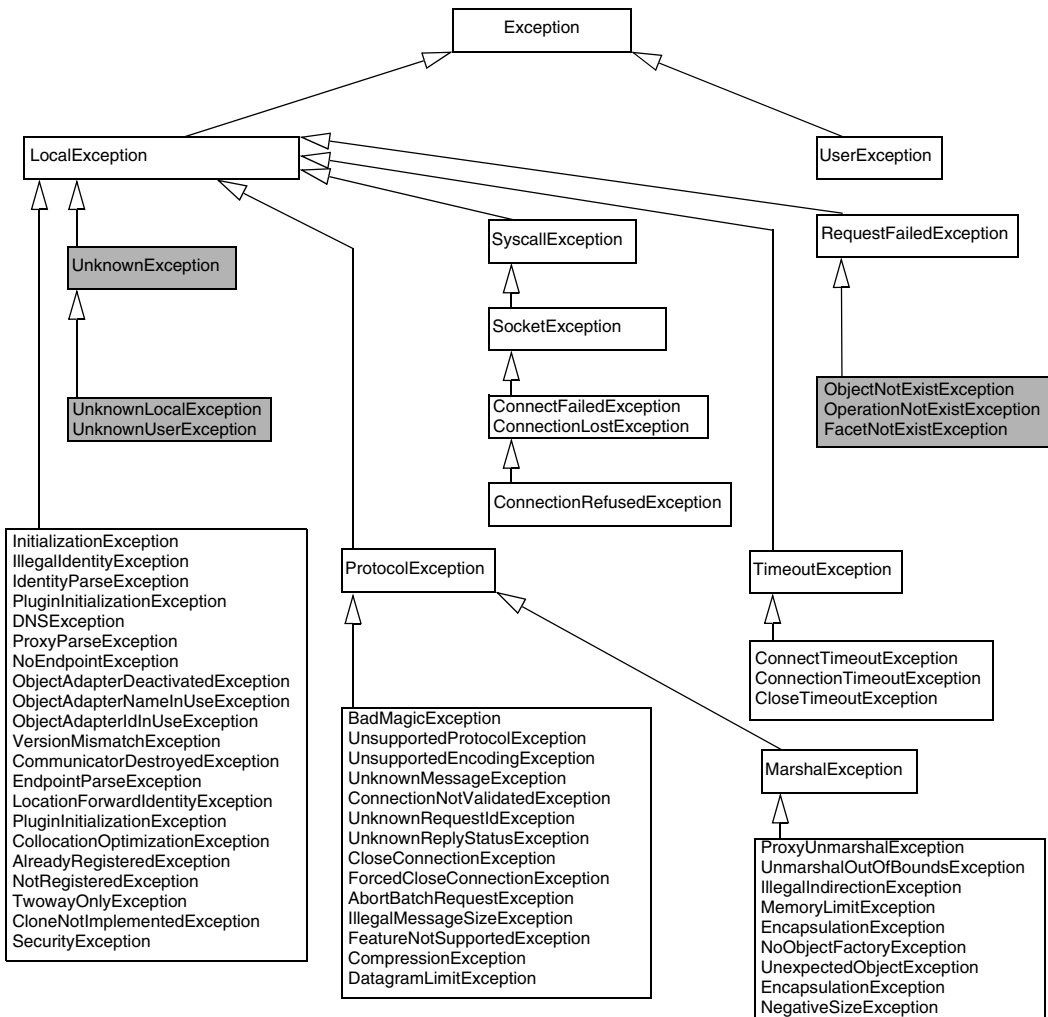

Figure 4.3. Inheritance structure for exceptions.

`Ice::Exception` is at the root of the inheritance hierarchy. Derived from that are the (abstract) types `Ice::LocalException` and `Ice::UserException`. In turn, all run-time exceptions are derived from `Ice::LocalException`, and all user exceptions are derived from `Ice::UserException`.

Figure 4.4 shows the complete hierarchy of the Ice run-time exceptions.⁶**Figure 4.4.** Ice run-time exception hierarchy. (Shaded exceptions can be sent by the server.)

6. We use the Unified Modeling Language (UML) for the object model diagrams in this book (see [1] and [13] for details).

Note that Figure 4.4 groups several exceptions into a single box to save space (which, strictly, is incorrect UML syntax). Also note that some run-time exceptions have data members, which, for brevity, we have omitted in Figure 4.4. These data members provide additional information about the precise cause of an error.

Many of the run-time exceptions have self-explanatory names, such as `MemoryLimitException`. Others indicate problems in the Ice run time, such as `EncapsulationException`. Still others can arise only through application programming errors, such as `NotRegisteredException`. In practice, you will likely never see most of these exceptions. However, there are a few run-time exceptions you will encounter and whose meaning you should know.

Local Versus Remote Exceptions

Most error conditions are detected on the client side. For example, if an attempt to contact a server fails, the client-side run time raises a `ConnectTimeoutException`. However, there are three specific error conditions (shaded in Figure 4.4) that are detected by the server and made known explicitly to the client-side run time via the Ice protocol:

- `ObjectNotExistException`

This exception indicates that a request was delivered to the server but the server could not locate a servant with the identity that is embedded in the proxy. In other words, the server could not find an object to dispatch the request to.

An `ObjectNotExistException` is a death certificate: it indicates that the target object in the server does not exist.⁷ Most likely, this is the case because the object existed some time in the past and has since been destroyed, but the same exception is also raised if a client uses a proxy with the identity of an object that has never been created. If you receive this exception, you are expected to clean up whatever resources you might have allocated that relate to the specific object for which you receive this exception.

- `FacetNotExistException`

The client attempted to contact a non-existent facet of an object, that is, the server has at least one servant with the given identity, but no servant with a matching facet name. (See Chapter 33 for a discussion of facets.)

7. The Ice run time raises `ObjectNotExistException` only if there are no facets in existence with a matching identity; otherwise, it raises `FacetNotExistException` (see Chapter 33).

- `OperationNotExistException`

This exception is raised if the server could locate an object with the correct identity but, on attempting to dispatch the client's operation invocation, the server found that the target object does not have such an operation. You will see this exception in only two cases:

- You have used an unchecked down-cast on a proxy of the incorrect type. (See page 205 and page 321 for unchecked down-casts.)
- Client and server have been built with Slice definitions for an interface that disagree with each other, that is, the client was built with an interface definition for the object that indicates that an operation exists, but the server was built with a different version of the interface definition in which the operation is absent.

Any error condition on the server side that is not described by one of the three preceding exceptions is made known to the client as one of three generic exceptions (shaded in Figure 4.4):

- `UnknownUserException`

This exception indicates that an operation implementation has thrown a Slice exception that is not declared in the operation's exception specification (and is not derived from one of the exceptions in the operation's exception specification).

- `UnknownLocalException`

If an operation implementation raises a run-time exception other than `ObjectNotExistException`, `FacetNotExistException`, or `OperationNotExistException` (such as a `NotRegisteredException`), the client receives an `UnknownLocalException`. In other words, the Ice protocol does not transmit the exact exception that was encountered in the server, but simply returns a bit to the client in the reply to indicate that the server encountered a run-time exception.

A common cause for a client receiving an `UnknownLocalException` is failure to catch and handle all exceptions in the server. For example, if the implementation of an operation encounters an exception it does not handle, the exception propagates all the way up the call stack until the stack is unwound to the point where the Ice run time invoked the operation. The Ice run time catches all Ice exceptions that "escape" from an operation invocation and returns them to the client as an `UnknownLocalException`.

- `UnknownException`

An operation has thrown a non-Ice exception. For example, if the operation in the server throws a C++ exception, such as a `char *`, or a Java exception, such as a `ClassCastException`, the client receives an `UnknownException`.

All other run-time exceptions (not shaded in Figure 4.4) are detected by the client-side run time and are raised locally.

It is possible for the implementation of an operation to throw Ice run-time exceptions (as well as user exceptions). For example, if a client holds a proxy to an object that no longer exists in the server, your server application code is required to throw an `ObjectNotExistException`. If you do throw run-time exceptions from your application code, you should take care to throw a run-time exception only if appropriate, that is, do not use run-time exceptions to indicate something that really should be a user exception. Doing so can be very confusing to the client: if the application “hijacks” some run-time exceptions for its own purposes, the client can no longer decide whether the exception was thrown by the Ice run time or by the server application code. This can make debugging very difficult.

4.10.5 Interface Semantics and Proxies

Building on the `Clock` example, we can create definitions for a world-time server:

```
exception GenericError {
    string reason;
};

struct TimeOfDay {
    short hour;           // 0 - 23
    short minute;        // 0 - 59
    short second;        // 0 - 59
};

exception BadTimeVal extends GenericError {};

interface Clock {
    nonmutating TimeOfDay getTime();
    idempotent void setTime(TimeOfDay time) throws BadTimeVal;
};

dictionary<string, Clock*> TimeMap; // Time zone name to clock map
```

```

exception BadZoneName extends GenericError {};

interface WorldTime {
    idempotent void addZone(string zoneName, Clock* zoneClock);
    void removeZone(string zoneName) throws BadZoneName;
    nonmutating Clock* findZone(string zoneName)
                                throws BadZoneName;
    nonmutating TimeMap listZones();
    idempotent void setZones(TimeMap zones);
};

```

The `WorldTime` interface acts as a collection manager for clocks, one for each time zone. In other words, the `WorldTime` interface manages a collection of pairs. The first member of each pair is a time zone name; the second member of the pair is the clock that provides the time for that zone. The interface contains operations that permit you to add or remove a clock from the map (`addZone` and `removeZone`), to search for a particular time zone by name (`findZone`), and to read or write the entire map (`listZones` and `setZones`).

The `WorldTime` example illustrates an important Slice concept: note that `addZone` accepts a parameter of type `Clock*` and `findZone` returns a parameter of type `Clock*`. In other words, interfaces are types in their own right and can be passed as parameters. The `*` operator is known as the *proxy operator*. Its left-hand argument must be an interface (or class—see Section 4.11) and its return type is a proxy. A proxy is like a pointer that can denote an object. The semantics of proxies are very much like those of C++ class instance pointers:

- A proxy can be null (see page 119).
- A proxy can dangle (point at an object that is no longer there)
- Operations dispatched via a proxy use late binding: if the actual run-time type of the object denoted by the proxy is more derived than the proxy’s type, the implementation of the most-derived interface will be invoked.

When a client passes a `Clock` proxy to the `addZone` operation, the proxy denotes an actual `Clock` object in a server. The `Clock` *Ice object* denoted by that proxy may be implemented in the same server process as the `WorldTime` interface, or in a different server process. Where the `Clock` object is physically implemented matters neither to the client nor to the server implementing the `WorldTime` interface; if either invokes an operation on a particular clock, such as `getTime`, an RPC call is sent to whatever server implements that particular clock. In other words, a proxy acts as a local “ambassador” for the remote object; invoking an operation on the proxy forwards the invocation to the actual object implementation. If the

object implementation is in a different address space, this results in a remote procedure call; if the object implementation is collocated in the same address space, the Ice run time uses an ordinary local function call from the proxy to the object implementation.

Note that proxies also act very much like pointers in their sharing semantics: if two clients have a proxy to the same object, a state change made by one client (such as setting the time) will be visible to the other client.

Proxies are strongly typed (at least for statically typed languages, such as C++ and Java). This means that you cannot pass something other than a `Clock` proxy to the `addZone` operation; attempts to do so are rejected at compile time.

4.10.6 Interface Inheritance

Interfaces support inheritance. For example, we could extend our world-time server to support the concept of an alarm clock:

```
interface AlarmClock extends Clock {
    nonmutating TimeOfDay getAlarmTime();
    idempotent void      setAlarmTime(TimeOfDay alarmTime)
                        throws BadTimeVal;
};
```

The semantics of this are the same as for C++ or Java: `AlarmClock` is a subtype of `Clock` and an `AlarmClock` proxy can be substituted wherever a `Clock` proxy is expected. Obviously, an `AlarmClock` supports the same `getTime` and `setTime` operations as a `Clock` but also supports the `getAlarmTime` and `setAlarmTime` operations.

Multiple interface inheritance is also possible. For example, we can construct a radio alarm clock as follows:

```
interface Radio {
    void setFrequency(long hertz) throws GenericError;
    void setVolume(long dB) throws GenericError;
};

enum AlarmMode { RadioAlarm, BeepAlarm };

interface RadioClock extends Radio, AlarmClock {
    void      setMode(AlarmMode mode);
    AlarmMode getMode();
};
```

RadioClock extends both Radio and AlarmClock and can therefore be passed where a Radio, an AlarmClock, or a Clock is expected. The inheritance diagram for this definition looks as follows:

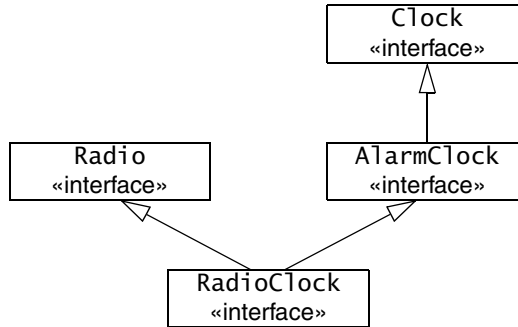

Figure 4.5. Inheritance diagram for RadioClock.

Interfaces that inherit from more than one base interface may share a common base interface. For example, the following definition is legal:

```

interface B { /* ... */ };
interface I1 extends B { /* ... */ };
interface I2 extends B { /* ... */ };
interface D extends I1, I2 { /* ... */ };
  
```

This definition results in the familiar diamond shape:

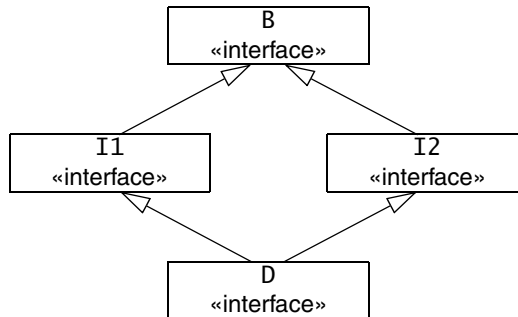

Figure 4.6. Diamond-shaped inheritance.

Interface Inheritance Limitations

If an interface uses multiple inheritance, it must not inherit the same operation name from more than one base interface. For example, the following definition is illegal:

```
interface Clock {
    void set(TimeOfDay time);           // set time
};

interface Radio {
    void set(long hertz);              // set frequency
};

interface RadioClock extends Radio, Clock { // Illegal!
    // ...
};
```

This definition is illegal because `RadioClock` inherits two `set` operations, `Radio::set` and `Clock::set`. The Slice compiler makes this illegal because (unlike C++) many programming languages do not have a built-in facility for disambiguating the different operations. In Slice, the simple rule is that all inherited operations must have unique names. (In practice, this is rarely a problem because inheritance is rarely added to an interface hierarchy “after the fact”. To avoid accidental clashes, we suggest that you use descriptive operation names, such as `setTime` and `setFrequency`. This makes accidental name clashes less likely.)

Implicit Inheritance from Object

All Slice interfaces are ultimately derived from `Object`. For example, the inheritance hierarchy from Figure 4.5 would be shown more correctly as in Figure 4.7.

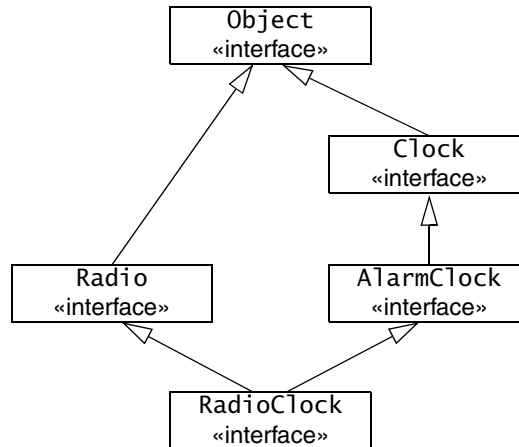

Figure 4.7. Implicit inheritance from `Object`.

Because all interfaces have a common base interface, we can pass any type of interface as that type. For example:

```

interface ProxyStore {
    idempotent void putProxy(string name, Object* o);
    nonmutating Object* getProxy(string name);
};
  
```

`Object` is a Slice keyword (note the capitalization) that denotes the root type of the inheritance hierarchy. The `ProxyStore` interface is a generic proxy storage facility: the client can call `putProxy` to add a proxy of any type under a given name and later retrieve that proxy again by calling `getProxy` and supplying that name. The ability to generically store proxies in this fashion allows us to build general-purpose facilities, such as a naming service that can store proxies and deliver them to clients. Such a service, in turn, allows us to avoid hard-coding proxy details into clients and servers (see Chapter 37).

Inheritance from type `Object` is always implicit. For example, the following Slice definition is illegal:

```

interface MyInterface extends Object { /* ... */ }; // Error!
  
```

It is understood that all interfaces inherit from type `Object`; you are not allowed to restate that.

Type `Object` is mapped to an abstract type by the various language mappings, so you cannot instantiate an Ice object of that type.

Null Proxies

Looking at the `ProxyStore` interface once more, we notice that `getProxy` does not have an exception specification. The question then is what should happen if a client calls `getProxy` with a name under which no proxy is stored? Obviously, we could add an exception to indicate this condition to `getProxy`. However, another option is to return a *null proxy*. Ice has the built-in notion of a null proxy, which is a proxy that “points nowhere”. When such a proxy is returned to the client, the client can test the value of the returned proxy to check whether it is null or denotes a valid object.

A more interesting question is: “which approach is more appropriate, throwing an exception or returning a null proxy?” The answer depends on the expected usage pattern of an interface. For example, if, in normal operation, you do not expect clients to call `getProxy` with a non-existent name, it is better to throw an exception. (This is probably the case for our `ProxyStore` interface: the fact that there is no `list` operation makes it clear that clients are expected to know which names are in use.)

On the other hand, if you expect that clients will occasionally try to look up something that is not there, it is better to return a null proxy. The reason is that throwing an exception breaks the normal flow of control in the client and requires special handling code. This means that you should throw exceptions only in exceptional circumstances. For example, throwing an exception if a database lookup returns an empty result set is wrong; it is expected and normal that a result set is occasionally empty.

It is worth paying attention to such design issues: well-designed interfaces that get these details right are easier to use and easier to understand. Not only do such interfaces make life easier for client developers, they also make it less likely that latent bugs cause problems later.

Self-Referential Interfaces

Proxies have pointer semantics, so we can define self-referential interfaces. For example:

```
interface Link {
    nonmutating SomeType getValue();
    nonmutating Link* next();
};
```

The `Link` interface contains a `next` operation that returns a proxy to a `Link` interface. Obviously, this can be used to create a chain of interfaces; the final link in the chain returns a null proxy from its `next` operation.

Empty Interfaces

The following Slice definition is legal:

```
interface Empty {};
```

The Slice compiler will compile this definition without complaint. An interesting question is: “why would I need an empty interface?” In most cases, empty interfaces are an indication of design errors. Here is one example:

```
interface ThingBase {};
```

```
interface Thing1 extends ThingBase {
    // Operations here...
};
```

```
interface Thing2 extends ThingBase {
    // Operations here...
};
```

Looking at this definition, we can make two observations:

- `Thing1` and `Thing2` have a common base and are therefore related.
- Whatever is common to `Thing1` and `Thing2` can be found in interface `ThingBase`.

Of course, looking at `ThingBase`, we find that `Thing1` and `Thing2` do not share any operations at all because `ThingBase` is empty. Given that we are using an object-oriented paradigm, this is definitely strange: in the object-oriented model, the *only* way to communicate with an object is to send a message to the object. But, to send a message, we need an operation. Given that `ThingBase` has no operations, we cannot send a message to it, and it follows that `Thing1` and `Thing2` are *not* related because they have no common operations. But of course, seeing that `Thing1` and `Thing2` have a common base, we conclude that they *are* related, otherwise the common base would not exist. At this point, most programmers begin to scratch their head and wonder what is going on here.

One common use of the above design is a desire to treat `Thing1` and `Thing2` polymorphically. For example, we might continue the previous definition as follows:

```
interface ThingUser {
    void putThing(ThingBase* thing);
};
```

Now the purpose of having the common base becomes clear: we want to be able to pass both `Thing1` and `Thing2` proxies to `putThing`. Does this justify the empty base interface? To answer this question, we need to think about what happens in the implementation of `putThing`. Obviously, `putThing` cannot possibly invoke an operation on a `ThingBase` because there are no operations. This means that `putThing` can do one of two things:

1. `putThing` can simply remember the value of `thing`.
2. `putThing` can try to down-cast to either `Thing1` or `Thing2` and then invoke an operation. The pseudo-code for the implementation of `putThing` would look something like this:

```
void putThing(ThingBase thing)
{
    if (is_a(Thing1, thing)) {
        // Do something with Thing1...
    } else if (is_a(Thing2, thing)) {
        // Do something with Thing2...
    } else {
        // Might be a ThingBase?
        // ...
    }
}
```

The implementation tries to down-cast its argument to each possible type in turn until it has found the actual run-time type of the argument. Of course, any object-oriented text book worth its price will tell you that this is an abuse of inheritance and leads to maintenance problems.

If you find yourself writing operations such as `putThing` that rely on artificial base interfaces, ask yourself whether you really need to do things this way. For example, a more appropriate design might be:

```
interface Thing1 {
    // Operations here...
};
```

```
interface Thing2 {
    // Operations here...
};

interface ThingUser {
    void putThing1(Thing1* thing);
    void putThing2(Thing2* thing);
};
```

With this design, `Thing1` and `Thing2` are not related, and `ThingUser` offers a separate operation for each type of proxy. The implementation of these operations does not need to use any down-casts, and all is well in our object-oriented world.

Another common use of empty base interfaces is the following:

```
interface PersistentObject {}

interface Thing1 extends PersistentObject {
    // Operations here...
};

interface Thing2 extends PersistentObject {
    // Operations here...
};
```

Clearly, the intent of this design is to place persistence functionality into the `PersistentObject` base *implementation* and require objects that want to have persistent state to inherit from `PersistentObject`. On the face of things, this is reasonable: after all, using inheritance in this way is a well-established design pattern, so what can possibly be wrong with it? As it turns out, there are a number of things that are wrong with this design:

- The above inheritance hierarchy is used to add *behavior* to `Thing1` and `Thing2`. However, in a strict OO model, behavior can be invoked only by sending messages. But, because `PersistentObject` has no operations, no messages can be sent.

This raises the question of how the implementation of `PersistentObject` actually goes about doing its job; presumably, it knows something about the implementation (that is, the internal state) of `Thing1` and `Thing2`, so it can write that state into a database. But, if so, `PersistentObject`, `Thing1`, and `Thing2` can no longer be implemented in different address spaces because, in

that case, `PersistentObject` can no longer get at the state of `Thing1` and `Thing2`.

Alternatively, `Thing1` and `Thing2` use some functionality provided by `PersistentObject` in order to make their internal state persistent. But `PersistentObject` does not have any operations, so how would `Thing1` and `Thing2` actually go about achieving this? Again, the only way that can work is if `PersistentObject`, `Thing1`, and `Thing2` are implemented in a single address space and share implementation state behind the scenes, meaning that they cannot be implemented in different address spaces.

- The above inheritance hierarchy splits the world into two halves, one containing persistent objects and one containing non-persistent ones. This has far-reaching ramifications:
 - Suppose you have an existing application with already implemented, non-persistent objects. Requirements change over time and you find that you now would like to make some of your objects persistent. With the above design, you cannot do this unless you change the type of your objects because they now must inherit from `PersistentObject`. Of course, this is extremely bad news: not only do you have to change the implementation of your objects in the server, you also need to locate and update all the clients that are currently using your objects because they suddenly have a completely new type. What is worse, there is no way to keep things backward compatible: either all clients change with the server, or none of them do. It is impossible for some clients to remain “unupgraded”.
 - The design does not scale to multiple features. Imagine that we have a number of additional behaviors that objects can inherit, such as serialization, fault-tolerance, persistence, and the ability to be searched by a search engine. We quickly end up in a mess of multiple inheritance. What is worse, each possible combination of features creates a completely separate type hierarchy. This means that you can no longer write operations that generically operate on a number of object types. For example, you cannot pass a persistent object to something that expects a non-persistent object, *even if the receiver of the object does not care about the persistence aspects of the object*. This quickly leads to fragmented and hard-to-maintain type systems. Before long, you will either find yourself rewriting your application or end up with something that is both difficult to use and difficult to maintain.

The foregoing discussion will hopefully serve as a warning: `Slice` is an *interface* definition language that has nothing to do with *implementation* (but empty inter-

faces almost always indicate that implementation state is shared via mechanisms other than defined interfaces). If you find yourself writing an empty interface definition, at least step back and think about the problem at hand; there may be a more appropriate design that expresses your intent more cleanly. If you do decide to go ahead with an empty interface regardless, be aware that, almost certainly, you will lose the ability to later change the distribution of the object model over physical server process because you cannot place an address space boundary between interfaces that share hidden state.

Interface Versus Implementation Inheritance

Keep in mind that Slice interface inheritance applies only to *interfaces*. In particular, if two interfaces are in an inheritance relationship, this in no way implies that the implementations of those interfaces must also inherit from each other. You can choose to use implementation inheritance when you implement your interfaces, but you can also make the implementations independent of each other. (To C++ programmers, this often comes as a surprise because C++ uses implementation inheritance by default, and interface inheritance requires extra effort to implement.)

In summary, Slice inheritance simply establishes type compatibility. It says nothing about how interfaces are implemented and, therefore, keeps implementation choices open to whatever is most appropriate for your application.

4.11 Classes

In addition to interfaces, Slice permits the definition of classes. Classes are like interfaces in that they can have operations and are like structures in that they can have data members. This leads to hybrid objects that can be treated as interfaces and passed by reference, or can be treated as values and passed by value. Classes provide much architectural flexibility. For example, classes allow behavior to be implemented on the client side, whereas interfaces allow behavior to be implemented only on the server side.

Classes support inheritance and are therefore polymorphic: at run time, you can pass a class instance to an operation as long as the actual class type is derived from the formal parameter type in the operation's signature. This also permits classes to be used as type-safe unions, similarly to Pascal's discriminated variant records.

4.11.1 Simple Classes

A Slice class definition is similar to a structure definition, but uses the `class` keyword. For example:

```
class TimeOfDay {
    short hour;           // 0 - 23
    short minute;        // 0 - 59
    short second;        // 0 - 59
};
```

Apart from the keyword `class`, this definition is identical to the structure definition we saw on page 93. You can use a Slice class wherever you can use a Slice structure (but, as we will see shortly, for performance reasons, you should not use a class where a structure is sufficient). Unlike structures, classes can be empty:

```
class EmptyClass {};    // OK
struct EmptyStruct {}; // Error
```

Much the same design considerations as for empty interfaces (see page 120) apply to empty classes: you should at least stop and rethink your approach before committing yourself to an empty class.

4.11.2 Class Inheritance

Unlike structures, classes support inheritance. For example:

```
class TimeOfDay {
    short hour;           // 0 - 23
    short minute;        // 0 - 59
    short second;        // 0 - 59
};

class DateTime extends TimeOfDay {
    short day;           // 1 - 31
    short month;         // 1 - 12
    short year;          // 1753 onwards
};
```

This example illustrates one major reason for using a class: a class can be extended by inheritance, whereas a structure is not extensible. The previous example defines `DateTime` to extend the `TimeOfDay` class with a date.⁸

Classes only support single inheritance. The following is illegal:

```
class TimeOfDay {
    short hour;           // 0 - 23
    short minute;        // 0 - 59
    short second;        // 0 - 59
};

class Date {
    short day;
    short month;
    short year;
};

class DateTime extends TimeOfDay, Date { // Error!
    // ...
};
```

A derived class also cannot redefine a data member of its base class:

```
class Base {
    int integer;
};

class Derived extends Base {
    int integer;           // Error, integer redefined
};
```

4.11.3 Class Inheritance Semantics

Classes use the same pass-by-value semantics as structures. If you pass a class instance to an operation, the class and all its members are passed. The usual type compatibility rules apply: you can pass a derived instance where a base instance is expected. If the receiver has static type knowledge of the actual derived run-time type, it receives the derived instance; otherwise, if the receiver does not have static type knowledge of the derived type, the instance is sliced to the base type. For an example, suppose we have the following definitions:

8. If you are puzzled by the comment about the year 1753, search the Web for “1752 date change”. The intricacies of calendars for various countries prior to that year can keep you occupied for months...

```
// In file Clock.ice:

class TimeOfDay {
    short hour;          // 0 - 23
    short minute;       // 0 - 59
    short second;       // 0 - 59
};

interface Clock {
    TimeOfDay getTime();
    void setTime(TimeOfDay time);
};

// In file DateTime.ice:

#include <Clock.ice>

class DateTime extends TimeOfDay {
    short day;          // 1 - 31
    short month;       // 1 - 12
    short year;        // 1753 onwards
};
```

Because `DateTime` is a sub-class of `TimeOfDay`, the server can return a `DateTime` instance from `getTime`, and the client can pass a `DateTime` instance to `setTime`. In this case, if both client and server are linked to include the code generated for both `Clock.ice` and `DateTime.ice`, they each receive the actual derived `DateTime` instance, that is, the actual run-time type of the instance is preserved.

Contrast this with the case where the server is linked to include the code generated for both `Clock.ice` and `DateTime.ice`, but the client is linked only with the code generated for `Clock.ice`. In other words, the server understands the type `DateTime` and can return a `DateTime` instance from `getTime`, but the client only understands `TimeOfDay`. In this case, the derived `DateTime` instance returned by the server is sliced to its `TimeOfDay` base type in the client. (The information in the derived part of the instance is simply lost to the client.)

Class hierarchies are useful if you need polymorphic *values* (instead of polymorphic *interfaces*). For example:

```
class Shape {
    // Definitions for shapes, such as size, center, etc.
};

class Circle extends Shape {
```

```

    // Definitions for circles, such as radius...
};

class Rectangle extends Shape {
    // Definitions for rectangles, such as width and length...
};

sequence<Shape> ShapeSeq;

interface ShapeProcessor {
    void processShapes(ShapeSeq ss);
};

```

Note the definition of `ShapeSeq` and its use as a parameter to the `processShapes` operation: the class hierarchy allows us to pass a polymorphic sequence of shapes (instead of having to define a separate operation for each type of shape).

The receiver of a `ShapeSeq` can iterate over the elements of the sequence and down-cast each element to its actual run-time type. (The receiver can also ask each element for its type ID to determine its type—see Section 6.14.1 and Section 10.11.2.)

4.11.4 Classes as Unions

Slice does not offer a dedicated union construct because it is redundant. By deriving classes from a common base class, you can create the same effect as with a union:

```

interface ShapeShifter {
    Shape translate(Shape s, long xDistance, long yDistance);
};

```

The parameter `s` of the `translate` operation can be viewed as a union of two members: a `Circle` and a `Rectangle`. The receiver of a `Shape` instance can use the type ID (see Section 4.13) of the instance to decide whether it received a `Circle` or a `Rectangle`. Alternatively, if you want something more along the lines of a conventional discriminated union, you can use the following approach:

```

class UnionDiscriminator {
    int d;
};

class Member1 extends UnionDiscriminator {
    // d == 1
    string s;
};

```

```
        float f;
    };

    class Member2 extends UnionDiscriminator {
        // d == 2
        byte b;
        int i;
    };
```

With this approach, the `UnionDiscriminator` class provides a discriminator value. The “members” of the union are the classes that are derived from `UnionDiscriminator`. For each derived class, the discriminator takes on a distinct value. The receiver of such a union uses the discriminator value in a `switch` statement to select the active union member.

4.11.5 Self-Referential Classes

Classes can be self-referential. For example:

```
class Link {
    SomeType value;
    Link next;
};
```

This looks very similar to the self-referential interface example on page 120, but the semantics are very different. Note that `value` and `next` are data members, not operations, and that the type of `next` is `Link` (*not* `Link*`). As you would expect, this forms the same linked list arrangement as the `Link` interface on page 120: each instance of a `Link` class contains a `next` member that points at the next link in the chain; the final link’s `next` member contains a null value. So, what looks like a class including itself really expresses pointer semantics: the `next` data member contains a pointer to the next link in the chain.

You may be wondering at this point what the difference is then between the `Link` interface on page 120 and the `Link` class on page 129. The difference is that classes have *value* semantics, whereas proxies have *reference* semantics. To illustrate this, consider the `Link` *interface* from page 120 once more:

```
interface Link {
    nonmutating SomeType getValue();
    nonmutating Link* next();
};
```

Here, `getValue` and `next` are both operations and the return value of `next` is `Link*`, that is, `next` returns a *proxy*. A proxy has *reference semantics*, that is, it denotes an object somewhere. If you invoke the `getValue` operation on a `Link` proxy, a message is sent to the (possibly remote) servant for that proxy. In other words, for proxies, the object stays put in its server process and we access the state of the object via remote procedure calls. Compare this with the definition of our `Link` class:

```
class Link {
    SomeType value;
    Link next;
};
```

Here, `value` and `next` are data members and the type of `next` is `Link`, which has *value semantics*. In particular, while `next` looks and feels like a pointer, *it cannot denote an instance in a different address space*. This means that if we have a chain of `Link` instances, all of the instances are in our local address space and, when we read or write a value data member, we are performing local address space operations. This means that an operation that returns a `Link` instance, such as `getHead`, does not just return the head of the chain, *but the entire chain*, as shown in Figure 4.8.

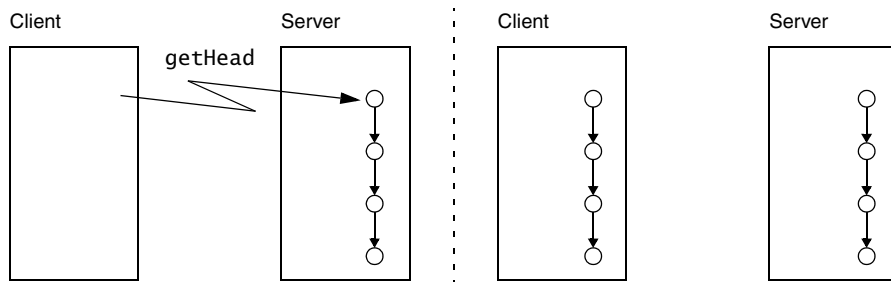

Figure 4.8. Class version of `Link` before and after calling `getHead`.

On the other hand, for the interface version of `Link`, we do not know where all the links are physically implemented. For example, a chain of four links could have each object instance in its own physical server process; those server processes could be each in a different continent. If you have a proxy to the head of this four-link chain and traverse the chain by invoking the `next` operation on each link, you will be sending four remote procedure calls, one to each object

Self-referential classes are particularly useful to model graphs. For example, we can create a simple expression tree along the following lines:

```
enum UnaryOp { UnaryPlus, UnaryMinus, Not };
enum BinaryOp { Plus, Minus, Multiply, Divide, And, Or };

class Node {};

class UnaryOperator extends Node {
    UnaryOp operator;
    Node operand;
};

class BinaryOperator extends Node {
    BinaryOp op;
    Node operand1;
    Node operand2;
};

class Operand extends Node {
    long val;
};
```

The expression tree consists of leaf nodes of type `Operand`, and interior nodes of type `UnaryOperator` and `BinaryOperator`, with one or two descendants, respectively. All three of these classes are derived from a common base class `Node`. Note that `Node` is an empty class. This is one of the few cases where an empty base class is justified. (See the discussion on page 120; once we add operations to this class hierarchy (see Section 4.11.7), the base class is no longer empty.)

If we write an operation that, for example, accepts a `Node` parameter, passing that parameter results in transmission of the entire tree to the server:

```
interface Evaluator {
    long eval(Node expression); // Send entire tree for evaluation
};
```

Self-referential classes are not limited to acyclic graphs; the Ice run time permits loops: it ensures that no resources are leaked and that infinite loops are avoided during marshaling.

4.11.6 Classes Versus Structures

One obvious question to ask is: why does Ice provide structures as well as classes, when classes obviously can be used to model structures? The answer has to do

with the cost of implementation: classes provide a number of features that are absent for structures:

- Classes support inheritance.
- Classes can be self-referential.
- Classes can have operations (see Section 4.11.7).
- Classes can implement interfaces (see Section 4.11.9).

Obviously, an implementation cost is associated with the additional features of classes, both in terms of the size of the generated code and the amount of memory and CPU cycles consumed at run time. On the other hand, structures are simple collections of values (“plain old structs”) and are implemented using very efficient mechanisms. This means that, if you use structures, you can expect better performance and smaller memory footprint than if you would use classes (especially for languages with direct support for “plain old structures”, such as C++ and C#). Use a class only if you need at least one of its more powerful features.

4.11.7 Classes with Operations

Classes, in addition to data members, can have operations. The syntax for operation definitions in classes is identical to the syntax for operations in interfaces. For example, we can modify the expression tree from Section 4.11.5 as follows:

```
enum UnaryOp { UnaryPlus, UnaryMinus, Not };
enum BinaryOp { Plus, Minus, Multiply, Divide, And, Or };

class Node {
    idempotent long eval();
};

class UnaryOperator extends Node {
    UnaryOp operator;
    Node operand;
};

class BinaryOperator extends Node {
    BinaryOp op;
    Node operand1;
    Node operand2;
};
```

```
class Operand {
    long val;
};
```

The only change compared to the version in Section 4.11.5 is that the `Node` class now has an `eval` operation. The semantics of this are as for a virtual member function in C++: each derived class inherits the operation from its base class and can choose to override the operation's definition. For our expression tree, the `Operand` class provides an implementation that simply returns the value of its `val` member, and the `UnaryOperator` and `BinaryOperator` classes provide implementations that compute the value of their respective subtrees. If we call `eval` on the root node of an expression tree, it returns the value of that tree, regardless of whether we have a complex expression or a tree that consists of only a single `Operand` node.

Operations on classes are always executed in the caller's address space, that is, operations on classes are *local* operations. Therefore, calling an operation on a class does not ever result in a remote procedure call. Of course, this immediately raises an interesting question: what happens if a client receives a class instance with operations from a server, but client and server are implemented in different languages? Classes with operations require the receiver to supply a factory for instances of the class. The Ice run time only marshals the data members of the class. If a class has operations, the receiver of the class must provide a class factory that can instantiate the class in the receiver's address space, and the receiver is responsible for providing an implementation of the class's operations.

Therefore, if you use classes with operations, it is understood that client and server each have access to an implementation of the class's operations. No code is shipped over wire (which, in an environment of heterogeneous nodes using different operating systems and languages is infeasible).

4.11.8 Architectural Implications of Classes

Classes have a number of architectural implications that are worth exploring in some detail.

Classes without Operations

Classes that do not use inheritance and only have data members (whether self-referential or not) pose no architectural problems: they simply are values that are marshaled like any other value, such as a sequence, structure, or dictionary.

Classes using derivation also pose no problems: if the receiver of a derived instance has knowledge of the derived type, it simply receives the derived type; otherwise, the instance is sliced to the most-derived type that is understood by the receiver. This makes class inheritance useful as a system is extended over time: you can create derived class without having to upgrade all parts of the system at once.

Classes with Operations

Classes with operations require additional thought. Here is an example: suppose that you are creating an Ice application. Also assume that the Slice definitions use quite a few classes with operations. You sell your clients and servers (both written in Java) and end up with thousands of deployed systems.

As time passes and requirements change, you notice a demand for clients written in C++. For commercial reasons, you would like to leave the development of C++ clients to customers or a third party but, at this point, you discover a glitch: your application has lots of classes with operations along the following lines:

```
class ComplexThingForExpertsOnly {
    // Lots of arcane data members here...
    MysteriousThing mysteriousOperation(/* parameters */);
    ArcaneThing arcaneOperation(/* parameters */);
    ComplexThing complexOperation(/* parameters */);
    // etc...
};
```

It does not matter what exactly these operations do. (Presumably, you decided to off-load some of the processing for your application onto the client side for performance reasons.) Now that you would like other developers to write C++ clients, it turns out that your application will work only if these developers provide implementations of all the client-side operations and, moreover, if the semantics of these operations exactly match the semantics of your Java implementations. Depending on what these operations do, providing exact semantic equivalents in a different language may not be trivial, so you decide to supply the C++ implementations yourself. But now, you discover another problem: the C++ clients need to be supported for a variety of operating systems that use a variety of different C++ compilers. Suddenly, your task has become quite daunting: you really need to supply implementations for all the combinations of operating systems and compiler versions that are used by clients. Given the different state of compliance with the ISO C++ standard of the various compilers, and the idiosyncrasies of different operating systems, you may find yourself facing a develop-

ment task that is much larger than anticipated. And, of course, the same scenario will arise again should you need client implementations in yet another language.

The moral of this story is not that classes with operations should be avoided; they can provide significant performance gains and are not necessarily bad. But, keep in mind that, once you use classes with operations, you are, in effect, using client-side native code and, therefore, you can no longer enjoy the implementation transparencies that are provided by interfaces. This means that classes with operations should be used only if you can tightly control the deployment environment of clients. If not, you are better off using interfaces and classes without operations. That way, all the processing stays on the server and the contract between client and server is provided solely by the Slice definitions, not by the semantics of the additional client-side code that is required for classes with operations.

Classes for Persistence

Ice also provides a built-in persistence mechanism that allows you to store the state of a class in a database with very little implementation effort. To get access to these persistence features, you must define a Slice class whose members store the state of the class. We discuss the persistence features of Slice in detail in Chapter 38.

4.11.9 Classes Implementing Interfaces

A Slice class can also be used as a servant in a server, that is, an instance of a class can be used to provide the behavior for an interface, for example:

```
interface Time {
    nonmutating TimeOfDay getTime();
    idempotent void setTime(TimeOfDay time);
};

class Clock implements Time {
    TimeOfDay time;
};
```

The `implements` keyword indicates that the class `Clock` provides an *implementation* of the `Time` interface. The class can provide data members and operations of its own; in the preceding example, the `Clock` class stores the current time that is accessed via the `Time` interface. A class can implement several interfaces, for example:

```
interface Time {
    nonmutating TimeOfDay getTime();
    idempotent void setTime(TimeOfDay time);
};

interface Radio {
    idempotent void setFrequency(long hertz);
    idempotent void setVolume(long dB);
};

class RadioClock implements Time, Radio {
    TimeOfDay time;
    long hertz;
};
```

The class `RadioClock` implements both `Time` and `Radio` interfaces.

A class, in addition to implementing an interface, can also extend another class:

```
interface Time {
    nonmutating TimeOfDay getTime();
    idempotent void setTime(TimeOfDay time);
};

class Clock implements Time {
    TimeOfDay time;
};

interface AlarmClock extends Time {
    nonmutating TimeOfDay getAlarmTime();
    idempotent void setAlarmTime(TimeOfDay alarmTime);
};

interface Radio {
    idempotent void setFrequency(long hertz);
    idempotent void setVolume(long dB);
};

class RadioAlarmClock extends Clock
    implements AlarmClock, Radio {
    TimeOfDay alarmTime;
    long hertz;
};
```

These definitions result in the inheritance graph shown in Figure 4.9:

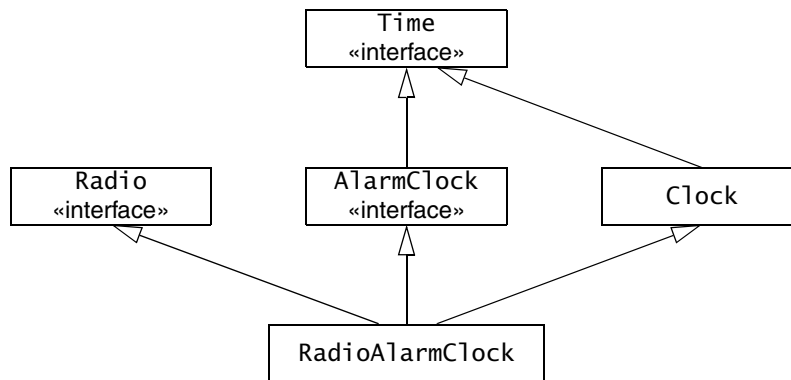

Figure 4.9. A Class using implementation and interface inheritance.

For this definition, `Radio` and `AlarmClock` are abstract interfaces, and `Clock` and `RadioAlarmClock` are concrete classes. As for Java, a class can implement multiple interfaces, but can extend at most one class.

4.11.10 Class Inheritance Limitations

As for interface inheritance, a class cannot redefine an operation or data member that it inherits from a base interface or class. For example:

```

interface BaseInterface {
    void op();
};

class BaseClass {
    int member;
};

class DerivedClass extends BaseClass implements BaseInterface {
    void someOperation();           // OK
    int op();                       // Error!
    int someMember;                 // OK
    long member;                    // Error!
};
  
```

4.11.11 Pass-by-Value Versus Pass-by-Reference

As we saw in Section 4.11.5, classes naturally support pass-by-value semantics: passing a class transmits the data members of the class to the receiver. Any changes made to these data members by the receiver affect only the receiver's copy of the class; the data members of the sender's class are not affected by the changes made by the receiver.

In addition to passing a class by value, you can pass a class by reference. For example:

```
class TimeOfDay {
    short hour;
    short minute;
    short second;
    string format();
};

interface Example {
    TimeOfDay* get(); // Note: returns a proxy!
};
```

Note that the `get` operation returns a *proxy* to a `TimeOfDay` class and not a `TimeOfDay` instance itself. The semantics of this are as follows:

- When the client receives a `TimeOfDay` proxy from the `get` call, it holds a proxy that differs in no way from an ordinary proxy for an interface.
- The client can invoke operations via the proxy, but *cannot* access the data members. This is because proxies do not have the concept of data members, but represent interfaces: even though the `TimeOfDay` class has data members, only its *operations* can be accessed via a the proxy.

The net effect is that, in the preceding example, the server holds an instance of the `TimeOfDay` class. A proxy for that instance was passed to the client. The only thing the client can do with this proxy is to invoke the `format` operation. The implementation of that operation is provided by the server and, when the client invokes `format`, it sends an RPC message to the server just as it does when it invokes an operation on an interface. The implementation of the `format` operation is entirely up to the server. (Presumably, the server will use the data members of the `TimeOfDay` instance it holds to return a string containing the time to the client.)

The preceding example looks somewhat contrived for classes only. However, it makes perfect sense if classes implement interfaces: parts of your application can exchange class instances (and, therefore, state) by value, whereas other parts of the system can treat these instances as remote interfaces. For example:

```
interface Time {
    string format();
    // ...
};

class TimeOfDay implements Time {
    short hour;
    short minute;
    short second;
};

interface I1 {
    TimeOfDay get();           // Pass by value
    void put(TimeOfDay time); // Pass by value
};

interface I2 {
    Time* get();               // Pass by reference
};
```

In this example, clients dealing with interface I1 are aware of the TimeOfDay class and pass it by value whereas clients dealing with interface I2 deal only with the Time interface. However, the actual implementation of the Time interface in the server uses TimeOfDay instances.

Be careful when designing systems that use such mixed pass-by-value and pass-by-reference semantics. Unless you are clear about what parts of the system deal with the interface (pass by reference) aspects and the class (pass by value) aspects, you can end up with something that is more confusing than helpful.

A good example of putting this feature to use can be found in Freeze (see Chapter 38), which allows you to add classes to an existing interface to implement persistence.

4.12 Forward Declarations

Both interfaces and classes can be forward declared. Forward declarations permit the creation of mutually dependent objects, for example:

```
module Family {
    interface Child;           // Forward declaration

    sequence<Child*> Children; // OK
};
```

```

interface Parent {
    Children getChildren(); // OK
};

interface Child {           // Definition
    Parent* getMother();
    Parent* getFather();
};
};

```

Without the forward declaration of `Child`, the definition obviously could not compile because `Child` and `Parent` are mutually dependent interfaces. You can use forward-declared interfaces and classes to define types (such as the `Children` sequence in the previous example). Forward-declared interfaces and classes are also legal as the type of a structure, exception, or class member, as the value type of a dictionary, and as the parameter and return type of an operation. However, you cannot inherit from a forward-declared interface or class until after its definition has been seen by the compiler:

```

interface Base;           // Forward declaration

interface Derived1 extends Base {}; // Error!

interface Base {};       // Definition

interface Derived2 extends Base {}; // OK, definition was seen

```

Not inheriting from a forward-declared base interface or class until its definition is seen is necessary because, otherwise, the compiler could not enforce that derived interfaces must not redefine operations that appear in base interfaces.⁹

4.13 Type IDs

Each user-defined Slice type has an internal type identifier, known as its *type ID*. The type ID is simply the fully-qualified name of each type. For example, the type ID of the `Child` interface in the preceding example is `::Family::Children::Child`. All type IDs for user-defined types start with a leading `::`, so the type ID of the `Family` module is `::Family` (not `Family`). In general, a type ID is

9. A multi-pass compiler could be used, but the added complexity is not worth it.

formed by starting with the global scope (`::`) and forming the fully-qualified name of a type by appending each module name in which the type is nested, and ending with the name of the type itself; the components of the type ID are separated by `::`.

The type ID of a proxy is formed by appending a `*` to the type ID of an interface or class. For example, the type ID of a `Child` proxy is `::Family::Children::Child*`.

The type ID of the `Slice Object` type is `::Ice::Object` and the type ID of an `Object` proxy is `::Ice::Object*`.

The type IDs for the remaining built-in types, such as `int`, `bool`, and so on, are the same as the corresponding keyword. For example, the type ID of `int` is `int`, and the type ID of `string` is `string`.

Type IDs are used internally by the Ice run time as a unique identifier for each type. For example, when an exception is raised, the marshaled form of the exception that is returned to the client is preceded by its Type ID on the wire. The client-side run time first reads the Type ID and, based on that, unmarshals the remainder of the data as appropriate for the type of the exception.

Type IDs are also used by the `ice_isA` operation (see page 142).

4.14 Operations on Object

The `Object` interface has a number of operations. We cannot define type `Object` in Slice because `Object` is a keyword; regardless, here is what (part of) the definition of `Object` would look like if it were legal:

```
sequence<string> StrSeq;

interface Object {                                     // "Pseudo" Slice!
    void ice_ping();
    bool ice_isA(string typeID);
    string ice_id();
    StrSeq ice_ids();
    // ...
};
```

Note that, apart from the illegal use of the keyword `Object` as the interface name, the operation names all contain an underscore. This is deliberate: by putting an underscore into these operation names, it becomes impossible for these built-in operations to ever clash with a user-defined operation. This means that all Slice

interfaces can inherit from `Object` without name clashes. There are three built-in operations that are commonly used:

- `ice_ping`

All interfaces support the `ice_ping` operation. That operation is useful for debugging because it provides a basic reachability test for an object: if the object exists and a message can successfully be dispatched to the object, `ice_ping` simply returns without error. If the object cannot be reached or does not exist, `ice_ping` throws a run-time exception that provides the reason for the failure.

- `ice_isA`

The `ice_isA` operation accepts a type identifier (such as the identifier returned by `ice_id`) and tests whether the target object supports the specified type, returning `true` if it does. You can use this operation to check whether a target object supports a particular type. For example, referring to Figure 4.7 once more, assume that you are holding a proxy to a target object of type `AlarmClock`. Table 4.2 illustrates the result of calling `ice_isA` on that proxy with various arguments. (We assume that all type in Figure 4.7 are defined in a module `Times`):

Table 4.2. Calling `ice_isA` on a proxy denoting an object of type `AlarmClock`.

Argument	Result
<code>::Ice::Object</code>	<code>true</code>
<code>::Times::Clock</code>	<code>true</code>
<code>::Times::AlarmClock</code>	<code>true</code>
<code>::Times::Radio</code>	<code>false</code>
<code>::Times::RadioClock</code>	<code>false</code>

As expected, `ice_isA` returns `true` for `::Times::Clock` and `::Times::AlarmClock` and also returns `true` for `::Ice::Object` (because *all* interfaces support that type). Obviously, an `AlarmClock` supports neither the `Radio` nor the `RadioClock` interfaces, so `ice_isA` returns `false` for these types.

- `ice_id`
The `ice_id` operation returns the type ID (see Section 4.13) of the most-derived type of an interface.
- `ice_ids`
The `ice_ids` operation returns a sequence of type IDs that contains all of the type IDs supported by an interface. For example, for the `RadioClock` interface in Figure 4.7, `ice_ids` returns a sequence containing the type IDs `::Ice::Object`, `::Times::Clock`, `::Times::AlarmClock`, `::Times::Radio`, and `::Times::RadioClock`.

4.15 Local Types

In order to access certain features of the Ice run time, you must use APIs that are provided by libraries. However, instead of defining an API that is specific to each implementation language, Ice defines its APIs in Slice using the `local` keyword. The advantage of defining APIs in Slice is that a single definition suffices to define the API for all possible implementation languages. The actual language-specific API is then generated by the Slice compiler for each implementation language. Types that are provided by Ice libraries are defined using the Slice `local` keyword. For example:

```
module Ice {  
    local interface ObjectAdapter {  
        // ...  
    };  
};
```

Any Slice definition (not just interfaces) can have a `local` modifier. If the `local` modifier is present, the Slice compiler does not generate marshaling code for the corresponding type. This means that a local type can *never* be accessed remotely because it cannot be transmitted between client and server. (The Slice compiler prevents use of `local` types in non-`local` contexts.)

In addition, local interfaces and local classes do *not* inherit from `Ice::Object`. Instead, local interfaces and classes have their own, completely

separate inheritance hierarchy. At the root of this hierarchy is the type `Ice::LocalObject`, as shown in Figure 4.10.

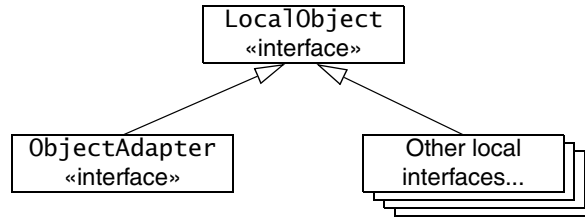

Figure 4.10. Inheritance from `LocalObject`

Because local interfaces form a completely separate inheritance hierarchy, you cannot pass a local interface where a non-local interface is expected and vice-versa.

You rarely need to define local types for your own applications—the `local` keyword exists mainly to allow definition of APIs for the Ice run time. (Because local objects cannot be invoked remotely, there is little point for an application to define local objects; it might as well define ordinary programming-language objects instead.) However, there is one exception to this rule: servant locators must be implemented as local objects (see Section 31.7).

4.16 Names and Scoping

Slice has a number of rules regarding identifiers. You will typically not have to concern yourself with these. However, occasionally, it is good to know how Slice uses naming scopes and resolves identifiers.

4.16.1 Naming Scopes

The following Slice constructs establish a naming scope:

- the global (file) scope
- modules
- interfaces
- classes
- structures

- exceptions
- enumerations
- parameter lists

Within a naming scope, identifiers must be unique, that is, you cannot use the same identifier for different purposes. For example:

```
interface Bad {  
    void op(int p, string p);    // Error!  
};
```

Because a parameter list forms a naming scope, it is illegal to use the same identifier `p` for different parameters. Similarly, data members, operation names, interface and class names, etc. must be unique within their enclosing scope.

4.16.2 Case Sensitivity

Identifiers that differ only in case are considered identical, so you must use identifiers that differ not only in capitalization within a naming scope. For example:

```
struct Bad {  
    int    m;  
    string M;    // Error!  
};
```

The Slice compiler also enforces consistent capitalization for identifiers. Once you have defined an identifier, you must use the same capitalization for that identifier thereafter. For example, the following is in error:

```
sequence<string> StringSeq;  
  
interface Bad {  
    stringSeq op();    // Error!  
};
```

Note that identifiers must not differ from a Slice keyword in case only. For example, the following is in error:

```
interface Module {    // Error, "module" is a keyword  
    // ...  
};
```

4.16.3 Qualified Names

The scope-qualification operator `::` allows you to refer to a type in a non-local scope. For example:

```
module Types {
    sequence<long> LongSeq;
};

module MyApp {
    sequence<Types::LongSeq> NumberTree;
};
```

Here, the qualified name `Types::LongSeq` refers to `LongSeq` defined in module `Types`. The global scope is denoted by a leading `::`, so we could also refer to `LongSeq` as `::Types::LongSeq`.

The scope-qualification operator also allows you to create mutually dependent interfaces that are defined in different modules. The obvious attempt to do this fails:

```
module Parents {
    interface Children::Child; // Syntax error!
    interface Mother {
        Children::Child* getChild();
    };
    interface Father {
        Children::Child* getChild();
    };
};

module Children {
    interface Child {
        Parents::Mother* getMother();
        Parents::Father* getFather();
    };
};
```

This fails because it is syntactically illegal to forward-declare an interface in a different module. To make it work, we must use a reopened module:

```
module Children {
    interface Child; // Forward declaration
};

module Parents {
    interface Mother {
```



```

        Children::Child* getChild();    // OK
    };
    interface Father {
        Children::Child* getChild();    // OK
    };
};

module Children {                       // Reopen module
    interface Child {                   // Define Child
        Parents::Mother* getMother();
        Parents::Father* getFather();
    };
};

```

While this technique works, it is probably of dubious value: mutually dependent interfaces are, by definition, tightly coupled. On the other hand, modules are meant to be used to place related definitions into the same module, and unrelated definitions into different modules. Of course, this begs the question: if the interfaces are so closely related that they depend on each other, why are they defined in different modules? In the interest of clarity, you probably should avoid this construct, even though it is legal.

4.16.4 Names in Nested Scopes

Names defined in an enclosing scope can be redefined in an inner scope. For example, the following is legal:

```

module Outer {
    sequence<string> Seq;

    module Inner {
        sequence<short> Seq;
    };
};

```

Within module `Inner`, the name `Seq` refers to a sequence of `short` values and hides the definition of `Outer::Seq`. You can still refer to the other definition by using explicit scope qualification, for example:

```

module Outer {
    sequence<string> Seq;

    module Inner {
        sequence<short> Seq;
    };
};

```

```
        struct Confusing {
            Seq      a;      // Sequence of short
            ::Outer::Seq b;  // Sequence of string
        };
};
```

Needless to say, you should try to avoid such redefinitions—they make it harder for the reader to follow the meaning of a specification.

Same-named constructs cannot be nested inside each other. For example, a module named *M* cannot (recursively) contain any construct also named *M*. The same is true for interfaces, classes, structures, exceptions, and operations. For example, the following examples are all in error:

```
module M {
    interface M { /* ... */ }; // Error!

    interface I {
        void I();           // Error!
        void op(string op); // Error!
    };

    struct S {
        long s;             // Error, even if case differs!
    };
};

module Outer {
    module Inner {
        interface Outer { // Error!
            // ...
        };
    };
};
```

The reason for this restriction is that nested types that have the same name are difficult to map into some languages. For example, C++ and Java reserve the name of a class as the name of the constructor, so an interface *I* could not contain an operation named *I* without artificial rules to avoid the name clash.

Similarly, some languages (such as C# and Visual Basic) do not permit a qualified name to be anchored at the global scope. If a nested module or type is

permitted to have the same name as the name of an enclosing module, it can become impossible to generate legal code in some cases.

In the interest of simplicity, Slice simply prohibits the name of a nested module or type to be the same as the name of one its enclosing modules.

4.16.5 Introduced Identifiers

Within a naming scope, an identifier is introduced at the point of first use; thereafter, within that naming scope, the identifier cannot change meaning. For example:

```
module M {
    sequence<string> Seq;

    interface Bad {
        Seq op1();    // Seq and op1 introduced here
        int Seq();   // Error, Seq has changed meaning
    };
};
```

The declaration of `op1` uses `Seq` as its return type, thereby introducing `Seq` into the scope of interface `Bad`. Thereafter, `Seq` can only be used as a type name that denotes a sequence of strings, so the compiler flags the declaration of the second operation as an error.

Note that fully-qualified identifiers are *not* introduced into the current scope:

```
module M {
    sequence<string> Seq;

    interface Bad {
        ::M::Seq op1(); // Only op1 introduced here
        int Seq();     // OK
    };
};
```

In general, a fully-qualified name (one that is anchored at the global scope and, therefore, begins with a `::` scope resolution operator) does not introduce any name into the current scope. On the other hand, qualified name that is not anchored at the global scope introduces only the first component of the name:

```
module M {
    sequence<string> Seq;

    interface Bad {
```

```

        M::Seq op1(); // M and op1 introduced here, but not Seq
        int Seq(); // OK
    };
};

```

4.16.6 Name Lookup Rules

When searching for the definition of a name that is not anchored at the global scope, the compiler first searches backward in the current scope of a definition of the name. If it can find the name in the current scope, it uses that definition. Otherwise, the compiler successively searches enclosing scopes for the name until it reaches the global scope. Here is an example to illustrate this:

```

module M1 {
    sequence<double> Seq;

    module M2 {
        sequence<string> Seq; // OK, hides ::M1::Seq

        interface Base {
            Seq op1(); // Returns sequence of string
        };
    };

    module M3 {
        interface Derived extends M2::Base {
            Seq op2(); // Returns sequence of double
        };

        sequence<bool> Seq; // OK, hides ::M1::Seq

        interface I {
            Seq op(); // Returns sequence of bool
        };
    };

    interface I {
        Seq op(); // Returns sequence of double
    };
};

```

Note that `M2::Derived::op2` returns a sequence of `double`, even though `M1::Base::op1` returns a sequence of `string`. That is, the meaning of a type in a base interface is irrelevant to determining its meaning in a derived interface—the

compiler *always* searches for a definition only in the current scope and enclosing scopes, and *never* takes the meaning of a name from a base interface or class.

4.17 Metadata

Slice has the concept of a *metadata* directive. For example:

```
["java:type:java.util.LinkedList"] sequence<int> IntSeq;
```

A metadata directive can appear as a prefix to any Slice definition. Metadata directives appear in a pair of square brackets and contain one or more string literals separated by commas. For example, the following is a syntactically valid metadata directives containing two strings:

```
["a", "b"] interface Example {};
```

Metadata directives are not part of the Slice language per se: the presence of a metadata directive has no effect on the client–server contract, that is, metadata directives do not change the Slice type system in any way. Instead, metadata directives are targeted at specific back-ends, such as the code generator for a particular language mapping. In the preceding example, the `java:` prefix indicates that the directive is targeted at the Java code generator.

Metadata directives permit you to provide supplementary information that does not change the Slice types being defined, but somehow influences how the compiler will generate code for these definitions. For example, a metadata directive `java:type:java.util.LinkedList` instructs the Java code generator to map a sequence to a linked list instead of an array (which is the default).

Metadata directives are also used to create proxies and skeletons that support *Asynchronous Method Invocation (AMI)* and *Asynchronous Method Dispatch (AMD)* (see Chapter 32).

Apart from metadata directives that are attached to a specific definition, there are also global metadata directives. For example:

```
[["java:package:com.acme"]]
```

Note that a global metadata directive is enclosed by double square brackets, whereas a local metadata directive (one that is attached to a specific definition) is enclosed by single square brackets. Global metadata directives are used to pass instructions that affect the entire compilation unit. For example, the preceding metadata directive instructs the Java code generator to generate the contents of the

source file into the Java package `com.acme`. Global metadata directives must precede any definitions in a file (but can appear following any `#include` directives).

We discuss specific metadata directives in the relevant chapters to which they apply.

4.18 Deprecating Slice Definitions

All Slice compilers support a metadata directive that allows you to deprecate a Slice definition. For example:

```
interface Example {
    ["deprecated:someOperation() has been deprecated, \
 use alternativeOperation() instead."]
    void someOperation();

    void alternativeOperation();
};
```

The [“deprecated”] metadata directive causes the compiler to emit code that generates a warning if you compile application code that uses a deprecated feature. This is useful if you want to remove a feature from a Slice definition but do not want to cause a hard error.

The message that follows the colon is optional; if you omit the message and use [“deprecated”], the Slice compilers insert a default message into the generated code.

You can apply the [“deprecated”] metadata directive to Slice constructs other than operations (for example, a structure or sequence definition).

4.19 Using the Slice Compilers

Ice provides a separate Slice compiler for each language mapping, as shown in Table 4.3.

Table 4.3. The Slice compilers.

Language	Compiler
C++	<code>slice2cpp</code>
Java	<code>slice2java</code>
C#	<code>slice2cs</code>
Visual Basic .NET	<code>slice2vb</code>
Python	<code>slice2py</code>
Ruby	<code>slice2rb</code>

The compilers share a similar command-line syntax:

```
<compiler-name> [options] file...
```

Regardless of which compiler you use, a number of command-line options are common to the compilers for any language mapping. (See the appropriate language mapping chapter for options that are specific to a particular language mapping.) The common command-line options are:

- **-h, --help**
Displays a help message.
- **-v, --version**
Displays the compiler version.
- **-DNAME¹⁰**
Defines the preprocessor symbol **NAME**.

10. Note that the preprocessor may not be supported in future versions of Slice, so use these options with caution.

- **-DNAME=DEF**¹⁰
Defines the preprocessor symbol **NAME** with the value **DEF**.
- **-UNAME**¹⁰
Undefines the preprocessor symbol **NAME**.
- **-IDIR**
Add the directory **DIR** to the search path for `#include` directives.
- **-E**
Print the preprocessor output on `stdout`.
- **--output-dir DIR**
Place the generated files into directory **DIR**.
- **-d, --debug**
Print debug information showing the operation of the Slice parser.
- **--ice**
Permit use of the normally reserved prefix `Ice` for identifiers. Use this option only when compiling the source code for the Ice run time.

The Slice compilers permit you to compile more than a single source file, so you can compile several Slice definitions at once, for example:

```
slice2cpp -I. file1.ice file2.ice file3.ice
```

4.20 Slice Checksums

As distributed applications evolve, developers and system administrators must be careful to ensure that deployed components are using the same client–server contract. Unfortunately, mistakes do happen, and it is not always readily apparent when they do.

To minimize the chances of this situation, the Slice compilers support an option that generates checksums for Slice definitions, thereby enabling two peers to verify that they share an identical client–server contract. The checksum for a Slice definition includes details such as parameter and member names and the order in which operations are defined, but ignores information that is not relevant to the client–server contract, such as metadata, comments, and formatting.

This option causes the Slice compiler to construct a dictionary that maps Slice type identifiers to checksums. A server typically supplies an operation that returns

its checksum dictionary for the client to compare with its local version, at which point the client can take action if it discovers a mismatch.

The dictionary type is defined in the file `Ice/SliceChecksumDict.ice` as follows:

```
module Ice {
    dictionary<string, string> SliceChecksumDict;
};
```

This type can be incorporated into an application's Slice definitions like this:

```
#include <Ice/SliceChecksumDict.ice>

interface MyServer {
    nonmutating Ice::SliceChecksumDict getSliceChecksums();
    ...
};
```

The key of each element in the dictionary is a Slice type ID (see Section 4.13), and the value is the checksum of that type.

For more information on generating and using Slice checksums, see the appropriate language mapping chapter.

4.21 A Comparison of Slice and CORBA IDL

It is instructive to compare Slice and CORBA IDL because the different feature sets of the two languages illustrate a number of design principles. In this section, we briefly compare the two languages and explain the motivation for the presence or absence of each feature.

Slice is neither a subset nor a superset of CORBA IDL. Instead, Slice both removes and adds features. The overall result is a specification language that is both simpler and more powerful than CORBA IDL, as we will see in the following sections.

4.21.1 Slice Features that are Missing in CORBA IDL

Slice adds a number of features over CORBA IDL. The main additions are:

- Exception inheritance

Lack of inheritance for exceptions in CORBA IDL has long been a thorn in the side of CORBA programmers. The absence of exception inheritance in

CORBA IDL prevents natural mappings to languages with equivalent native exception support, such as C++ and Java. In turn, this makes it difficult to implement structured error handling.

As a result, CORBA applications typically use a plethora of exception handlers following each call or block of calls or, at the other extreme, use only generic exception handling at too high a level to still yield useful diagnostics. The trade-off imposed by this is rather draconian: either you have good error handling and diagnostics, but convoluted and difficult-to-maintain code, or you sacrifice error handling in order to keep the code clean.

- Dictionaries

“How do I send a Java hash table to a server?” is one of the most frequently asked questions for CORBA. The standard answer is to model the hash table as a sequence of structures, with each structure containing the key and value, copy the hash table into the sequence, send the sequence, and reconstruct the hash table at the other end.

Doing this is not only wasteful in CPU cycles and memory, but also pollutes the IDL with data types whose presence is motivated by limitations of the CORBA platform (instead of requirements of the application). Slice dictionaries provide support for sending efficient lookup tables as a first-class concept and eliminate the waste and obfuscation of the CORBA approach.

- Nonmutating and idempotent operations

Knowing that an operation will not modify the state of its object permits the Ice run time to transparently recover from transient errors that otherwise would have to be handled by the application. This makes for a more reliable and convenient platform. In addition, nonmutating operations can be mapped to a corresponding construct (if available) in the target language, such as C++ `const` member functions. This improves the static type safety of the system.

- Classes

Slice provides classes that support both pass-by-value and pass-by-proxy semantics. In contrast, CORBA value types (which are somewhat similar) only support pass-by-value semantics: you cannot create a CORBA reference to a value type instance and invoke on that instance remotely.

Slice also uses classes for its automatic persistence mechanism (see Chapter 38). No equivalent feature is provided by CORBA.

- Metadata

Metadata directives permit the language to be extended in a controlled way without affecting the client–server contract. Asynchronous method invocation (AMI) and asynchronous method dispatch (AMD) are examples of the use of metadata directives.

4.21.2 CORBA IDL Features that are Missing in Slice

Slice deliberately drops quite a number of features of CORBA IDL. These can broadly be categorized as follows:

- Redundancies

Some CORBA IDL features are redundant in that they provide more than one way to achieve a single thing. This is undesirable for two reasons:

1. Providing more than one way of achieving the same thing carries a penalty in terms of code and data size. The resulting code bloat also causes performance penalties and so should be avoided.
2. Redundant features are unergonomic and confusing. A single feature is both easier to learn (for programmers) and easier to implement (for vendors) than two features that do the same thing. Moreover, there is always a niggling feeling of unease, especially for newcomers: “How come I can do this in two different ways? When is one style preferable over the other style? Are the two features really identical, or is there some subtle difference I am missing?” Not providing more than one way to do the same thing avoids these questions entirely.

- Non-features

A number of features of CORBA IDL are unnecessary, in the sense that they are hardly ever used. If there is a reasonable way of achieving something without a special-purpose feature, the feature should be absent. This results in a system that is easier to learn and use, and a system that is smaller and performs better than it would otherwise.

- Mis-features

Some features of CORBA IDL are mis-features in the sense that they do something that, if not outright wrong, is at least of questionable value. If the potential for abuse through ignorance of a feature is greater than its benefit, the feature should be omitted, again resulting in a simpler, more reliable, and better performing system.

Redundancies

1. IDL attributes

IDL attributes are a syntactic short-hand for an accessor operation (for read-only attributes) or a pair of accessor and a modifier operations (for writable attributes). The same thing can be achieved by simply defining an accessor and modifier operation directly.¹¹

Attributes introduce considerable complexity into the CORBA run time and APIs. (For example, programmers using the Dynamic Invocation Interface must remember that, to set or get an attribute, they have to use `_get_<attribute-name>` and `_set_<attribute-name>` whereas, for operations, the unadorned name must be used.)

2. Unsigned integers

Unsigned integers add very little to the type system but make it considerably more complex. In addition, if the target programming language does not support unsigned integers (Java does not), it becomes almost impossibly difficult to deal with out-of-range conditions. Currently, Java CORBA programmers deal with the problem by ignoring it. (See [9] for a very cogent discussion of the disadvantages of unsigned types.)

3. Underscores in identifiers

Whether or not identifiers should contain underscores is largely a matter of personal taste. However, it is important to have some range of identifiers reserved for the language mapping in order to avoid name clashes. For example, a CORBA IDL specification that contains the identifiers `T` and `T_var` in the same scope cannot be compiled into valid C++. (There are numerous other such conflicts, for C++ as well as other languages.)

Disallowing underscores in Slice identifiers guarantees that all valid Slice specifications can be mapped into valid programming language source code because, at the programming language level, underscores can reliably be used to avoid clashes.

4. Arrays

CORBA IDL offers both arrays and sequences (with sequences further divided into bounded and unbounded sequences). Given that a sequence can

¹¹.IDL attributes are also second-class citizens because, prior to CORBA 3.x, it was impossible to throw user exceptions from attribute accesses.

easily be used to model an array, there is no need for arrays. Arrays are somewhat more precise than sequences in that they allow you to state that precisely n elements are required instead of at most n . However, the minute gain in expressiveness is dearly paid for in complexity: not only do arrays contribute to code bloat, they also open a number of holes in the type system. (The CORBA C++ mapping suffers more from the weak type safety of arrays than from any other feature.)

5. Bounded sequences

Much the same arguments that apply to arrays also apply to bounded sequences. The gain in expressiveness of bounded sequences is not worth the complexity that is introduced into language mappings by the feature.

6. Self-referential structures via sequences

CORBA IDL permits structures to have a member that is of the type of its enclosing structure. While the feature is useful, it requires a curiously artificial sequence construct to express. With the introduction of CORBA valuetypes, the feature became redundant because valuetypes support the same thing more clearly and elegantly.

7. Repository ID versioning with `#pragma version`

`#pragma version` directives in CORBA IDL have no purpose whatsoever. The original intent was to allow versioning of interfaces. However, different minor and major version numbers do not actually define any notion of backward (non-)compatibility. Instead, they simply define a new type, which can also be achieved via other means.

Non-Features

1. Arrays

We previously classified arrays as a redundant feature. Experience has shown that arrays are a non-feature as well: after more than ten years of published IDL specifications, you can count the number of places where an array is used on the fingers of one hand.

2. Constant expressions

CORBA IDL allows you to initialize a constant with a constant expression, such as $X * Y$. While this seems attractive, it is unnecessary for a *specification* language. Given that all values involved are compile-time constants, it is entirely possible to work out the values once and write them into the specifica-

tion directly. (Again, the number of constant expressions in published IDL specifications can be counted on the fingers of one hand.)¹²

3. Types `char` and `wchar`

There simply is no need for a character type in a specification language such as slice. In the rare case where a character is required, type `string` can be used.¹³

4. Fixed-point types

Fixed-point types were introduced into CORBA to support financial applications that need to calculate monetary values. (Floating-point types are ill-suited to this because they cannot store a sufficient number of decimal digits and are subject to a number of undesirable rounding and representational errors.)

The cost of adding fixed-point types to CORBA in terms of code size and API complexity is considerable. Especially for languages without a native fixed-point type, a lot of supporting machinery must be provided to emulate the type. This penalty is paid over and over again, even for languages that are not normally chosen for financial calculations. Moreover, no-one actually does calculations with these types in IDL—instead, IDL simply acts as the vehicle to enable transmission of these types. It is entirely feasible (and simple to implement) to use strings to represent fixed-point values and to convert them into a native fixed-point type in the client and server.

5. Extended floating-point types

While there is a genuine need for extended floating-point types for some applications, the feature is difficult to provide without native support in the underlying hardware. As a result, support for extended floating-point types is widely unimplemented in CORBA. On platforms without extended floating-point support, the type is silently remapped to an ordinary `double`.

12. As of version 2.6.x of CORBA, the semantics of IDL constant expressions are still largely undefined: there are no rules for type coercion or how to deal with overflow, and there is no defined binary representation; the result of constant expressions is therefore implementation-dependent.

13. We cannot recall ever having seen a (non-didactic) IDL specification that uses type `char` or `wchar`.

Mis-Features

1. typedef

IDL typedef has probably contributed more to complexity, semantic problems, and bugs in applications than any other IDL feature. The problem with typedef is that it does not create a new type. Instead, it creates an alias for an existing type. Judiciously used, type definitions can improve readability of a specification. However, under the hood, the fact that a type can be aliased causes all sorts of problems. For many years, the entire notion of type equivalence was completely undefined in CORBA and it took many pages of specification with complex explanations to nail down the semantic complexities caused by aliased types.¹⁴

The complexity (both in the run time and in the APIs) disappears in absence of the feature: Slice does not permit a type to be aliased, so there can never be any doubt as to the name of a type and, hence, type equivalence.

2. Nested types

IDL allows you define types inside the scope of, for example, an interface or an exception, similar to C++. The amount of complexity created by this decision is staggering: the CORBA specification contains numerous and complex rules for dealing with the order of name lookup, exactly how to decide when a type is introduced into a scope, and how types may (or may not) hide other types of the same name. The complexity carries through into language mappings: nested type definitions result in more complex (and more bulky) source code and are difficult to deal with in languages that do not permit the same nesting of definitions as IDL.¹⁵

Slice allows types to be defined only at module scope. Experience shows that this is all that is needed and it avoids all the complexity.

3. Unions

As most OO textbooks will tell you, unions are not required; instead, you can use derivation from a base class to implement the same thing (and enjoy the benefit of type-safe access to the members of the class). IDL unions are yet another source of complexity that is entirely out of proportion to the utility of

14. CORBA 2.6.x still has some unresolved issues with respect to type equivalence.

15. Again, the number of published specifications that actually use nested type definitions can be counted on the fingers of one hand; yet, every CORBA platform must bear the resulting complexity.

the feature. Language mappings suffer badly from this. For example, the C++ mapping for IDL unions is something of a challenge even for experts. And, as with any other feature, unions extract a price in terms of code size and run-time performance.

4. #pragma

IDL allows the use of #pragma directives to control the contents of type IDs. This was a most unfortunate choice: because #pragma is a preprocessing directive, it is completely outside the normal scoping rules of the language. The resulting complexity is sufficient to take up several pages of explanations in the specification. (And, even with all those explanations, it is still possible to use #pragma directives that make no sense, yet cannot be diagnosed as erroneous.)

Slice does not permit control of type IDs because it simply is not necessary.

5. oneway operations

IDL permits an operation to be tagged with a oneway keyword. Adding this keyword causes the ORB to dispatch the operation invocation with “best-effort” semantics. In theory, the run time simply fires off the request and then forgets all about it, not caring whether the request is lost or not. In practice, there are a number of problems with this idea:

- oneway invocations are delivered via TCP/IP just as normal invocations are. Even though the server may not reply to a oneway request, the underlying TCP/IP implementation still attempts to guarantee delivery of the request. This means that, despite the oneway keyword, the sending ORB is still subject to flow control (meaning that the client application may block). In addition, at the TCP/IP level, there is return traffic from the server to the client even for a oneway request (in the form of acknowledgement and flow-control packets).
- The semantics of oneway invocations were poorly defined in earlier versions of CORBA and refined later, to allow the client to have some control over the delivery guarantees. Unfortunately, this resulted in yet more complexity in the application APIs and the ORB implementation.
- Architecturally, the use of oneway in IDL is dubious: IDL is an *interface* definition language, but oneway has nothing to do with interface. Instead, it controls an aspect of call dispatch that is quite independent of a specific interface. This begs the question of why oneway is a first-class language

concept when it has nothing to do with the contract between client and server.

Slice does not have a oneway keyword (even though Ice supports oneway invocations). This avoids contaminating Slice definitions with non-type related directives. For asynchronous method invocations, Slice uses metadata directives. The use of such metadata does in no way affect the client–server contract: if you delete all metadata definitions from a specification and then recompile only one of client or server, the interface contract between client and server remains unchanged and valid.

6. IDL contexts

IDL contexts are a general escape hatch that, in essence, permit a sequence of name–string pairs to be sent with every invocation of an operation; the server can examine the name–string pairs and use their contents to change its behavior. Unfortunately, IDL contexts are completely outside the type system and provide no guarantees whatsoever to either client or server: even if an operation has a context clause, there is no guarantee that the client will send any of the named contexts or send well-formed values for those contexts. CORBA has no idea of the meaning or type of these pairs and, therefore, cannot provide any assistance in assuring that their contents are correct (either at compile or run time). The net effect is that IDL contexts shoot a big hole through the IDL type system and result in systems that are hard to understand, code, and debug.

7. Wide strings

CORBA has the notion of supporting multiple codesets and character sets for wide strings, with a complex negotiation mechanism that is meant to permit client and server to agree on a particular codeset for transmission of wide strings. A large amount of complexity arises from this choice; as of CORBA 3.0, many ORB implementations still suffer interoperability problems for the exchange of wide string data. The specification still contains a number of unresolved problems that make it unlikely that interoperability will become a reality any time soon.

Slice uses Unicode for its wide strings, that is, there is a single character set and a single defined codeset for the transmission of wide strings. This greatly simplifies the implementation of the run time and avoids interoperability problems.

8. Type Any

The IDL Any type is a universal container type that can contain a value of any IDL type. The feature is somewhat similar to exchanging untyped data as a `void *` in C, but improved with introspection, so the type of the contents of an Any can be determined at run time. Unfortunately, type Any adds much complexity for little gain:

- The API to deal with type Any and its associated type description is arcane and complex. Code that uses type Any is extremely error-prone (particularly in C++). In addition, the language-mapping requires the generation of a large number of helper functions and operators that slow down compilations and take up considerable code and data space at run time.
- Despite the fact that type Any is self-describing and that each instance that is sent over the wire contains a complete (and bulky) description of the value's type, it is impossible for a process to receive and re-transmit a value of type Any without completely unmarshaling and remarshaling the value. This affects programs such as the CORBA Event Service: the extra marshaling cost dominates the overall execution time and limits performance unacceptably for many applications.

Slice uses classes to replace both IDL unions and type Any. This approach is simpler and more type safe than using type Any. In addition, the Slice protocol permits receipt and retransmission of values without forcing the data to be unmarshaled and remarshaled; this leads to smaller and better performing systems than what could be built with CORBA.

9. Anonymous types

Earlier versions of the CORBA specification permitted the use of anonymous IDL types (types that are defined in-line without assigning a separate name to them). Anonymous types caused major problems for language mappings and have since been deprecated in CORBA. However, the complexity of anonymous types is still visible due to backward compatibility concerns. Slice ensures that every type has a name and so prevents any of the problems that are caused by anonymous types.

4.22 Generating Slice Documentation

If you look at Appendix B, you will find reference documentation for all the Slice definitions used by Ice and its services. In the binary distributions of Ice, you will

also find HTML documentation that contains the same information. Both the PDF and the HTML documentation are generated from special comments in the Slice definitions by `slice2docbook`, a tool that scans Slice definitions for special comments and generates SGML in DocBook [25] format. The SGML then is post-processed by other tools to generate the final published documentation.

As an example of documentation comments, here is the definition of `Ice::Current`:

```
/**
 *
 * Information about the current method invocation for servers.
 * Each operation on the server has a [Current] as its implicit
 * final parameter. [Current] is mostly used for &Ice; services.
 * Most applications ignore this parameter.
 *
 */
local struct Current {
    /**
     * The object adapter.
     */
    ObjectAdapter adapter;

    /**
     * Information about the connection over which the current
     * method invocation was received. If the invocation is direct
     * due to collocation optimization, this value is set to null.
     */
    Connection con;

    /**
     * The &Ice; object identity.
     */
    Identity id;

    /**
     * The facet.
     */
    string facet;

    /**
     * The operation name.
     */
    string operation;

    /**
```

```

    * The mode of the operation.
    **/
    OperationMode mode;

    /**
    * The request context, as received from the client.
    **/
    Context ctx;

    /**
    * The request id unless oneway (0) or collocated (-1).
    **/
    int requestId;
};

```

If you look at the comments, you will see these reflected in the documentation for `Ice::Current` in Appendix B.

4.22.1 Documentation Comments

Any comment that starts with `/**` and ends with `**/` is a documentation comment. Such a comment can precede any Slice construct, such as a module, interface, structure, operation, and so on. Within a documentation comment, you can either start each line with a `*`, or you can leave the beginning of the line blank—**slice2docbook** can handle either convention:

```

/**
 *
 * This is a documentation comment for which every line
 * starts with a '*' character.
 **/

/**

This is a documentation comment without a leading '*'
for each line. Either style of comment is fine.

**/

```

The first sentence of the documentation comment for a Slice construct should be a summary sentence. **slice2docbook** generates an index of all Slice constructs and the first sentence of the comments for each Slice construct as a summary in that index.

Hyperlinks

Any Slice identifier enclosed in square brackets is presented as a hyperlink in code font. For example:

```
/**
 * An empty [name] denotes a null object.
 **/
```

This generates a hyperlink for the name markup that points at the definition of the corresponding Slice symbol. (The symbol can denote any Slice construct, such as a type, interface, parameter, or structure member.)

Explicit Cross-References

The directive @see is recognized by `slice2docbook`. Where it appears, the generated SGML contains a separate section titled “See Also”, followed by a list of Slice identifiers. For example:

```
/**
 * The object adapter, which is responsible for receiving requests
 * from endpoints, and for mapping between servants, identities,
 * and proxies.
 *
 * @see Communicator
 * @see ServantLocator
 **/
```

The Slice identifiers are listed in the corresponding “See Also” section as comma-separated hyperlinks in code font.

Markup for Operations

There are three directives specifically to document Slice operations: @param, @return, and @throws. For example:

```
/**
 * Look for an item with the specified
 * primary and secondary key.
 *
 * @param p The primary search key.
 *
 * @param s The secondary search key.
 *
 * @return The item that matches the specified keys.
 **/
```

```
* @throws NotFound Raised if no item matches the specified keys.
**/
```

Item `findItem(Key p, Key s)` throws `NotFound`;

slice2docbook generates separate “Parameters”, “Return Value”, and “Exceptions” sections for these directives. Parameters are listed in the same order as they appears in the comments. (For clarity, that order should match the order of declaration of parameters for the corresponding operation.)

General DocBook Markup

A documentation comment can contain any markup that is permitted by DocBook in that place. For example, you can create separate paragraphs with `<para>` and `</para>` elements:

```
/**
 * This is a comment for some Slice construct.
 *
 * <para>This comment appears in a separate paragraph.</para>
 **/
```

There are various other ways to create markup—for example, you can use `<literal>` and `<note>` elements. Please see the DocBook documentation for details.

4.22.2 Using `slice2docbook`

slice2docbook uses the following syntax:

```
slice2docbook [options] sgml_file slice_file...
```

sgml_file specifies the output file name for the generated SGML documentation. (The file name must end in `.sgml`.) If you have cross-references that span Slice files, you must compile all of the Slice files with a single invocation of **slice2docbook**.

The command supports the following options:

- **-h, --help**
Displays a help message.
- **-v, --version**
Displays the compiler version.

- **-DNAME**¹⁶
Defines the preprocessor symbol **NAME**.
- **-DNAME=DEF**¹⁰
Defines the preprocessor symbol **NAME** with the value **DEF**.
- **-UNAME**¹⁰
Undefines the preprocessor symbol **NAME**.
- **-IDIR**
Add the directory **DIR** to the search path for `#include` directives.
- **-E**
Print the preprocessor output on `stdout`.
- **-s, --stand-alone**
With this option, the top-level element of the generated SGML is an `<article>` element that contains all of the documentation as child elements. Without this option, the top-level elements are `<section>` elements (or `<chapter>` elements, if you use the **--chapter** option).
- **--chapter**
By default, the command generates separate `<section>` elements. With this option, the compiler emits a separate `<chapter>` element for each module, interface, class, exception, structure, and enumeration.
- **--noindex**
By default, the compiler generates an index that lists Slice types. The index contains a separate sections for modules, classes, interfaces, and so on. **--noindex** suppresses the generation of the index.
- **--sort-fields**
By default, the fields of structures, classes, and exceptions are presented in the order in which they are defined in the Slice definition. **--sort-fields** changes the fields to be presented in ascending alphabetical order.
- **-d, --debug**
Print debug information showing the operation of the Slice parser.

16. Note that the preprocessor may not be supported in future versions of Slice, so use these options with caution.

- `--ice`

Permit use of the normally reserved prefix `Ice` for identifiers. Use this option only when compiling the source code for the Ice run time.

4.23 Summary

Slice is the fundamental mechanism for defining the client–server contract. By defining data types and interfaces in Slice, you create a language-independent API definition that are translated by a compiler into an API specific for a particular programming language.

Slice provides the usual built-in types and allows you to create user-defined types of arbitrary complexity, such as sequences, enumerations, structures, dictionaries, and classes. Polymorphism is catered for via inheritance of interfaces, classes, and exceptions. In turn, exceptions provide you with facilities that permit sophisticated error reporting and handling. Modules permit you to group related parts of a specification and prevent pollution of the global namespace, and meta-data can be used to augment Slice definitions with directives for specific compiler backends.

`slice2docbook` permits you to integrate Slice documentation with existing documentation tools.

Chapter 5

Slice for a Simple File System

5.1 Chapter Overview

The remainder of this book uses a file system application to illustrate various aspects of Ice. Throughout the book, we progressively improve and modify the application such that it evolves into an application that is realistic and illustrates the architectural and coding aspects of Ice. This allows us to explore the capabilities of the platform to a realistic degree of complexity without overwhelming you with an inordinate amount of detail early on. Section 5.2 outlines the file system functionality, Section 5.3 develops the data types and interfaces that are required for the file system, and Section 5.4 presents the complete Slice definition for the application.

5.2 The File System Application

Our file system application implements a simple hierarchical file system, similar to the file systems we find in Windows or UNIX. To keep code examples to manageable size, we ignore many aspects of a real file system, such as ownership, permissions, symbolic links, and a number of other features. However, we build enough functionality to illustrate how you could implement a fully-featured file system, and we pay attention to things such as performance and scalability. In this

way, we can create an application that presents us with real-world complexity without getting buried in large amounts of code.

To begin with, the file system is non-distributed: although we implement the application in a server that is accessed by clients (so we can access the file system remotely), the initial version requires all files in the file system to be provided by a single server. This means that all directories and files below the root of the file system are implemented in a single server. (We discuss how to remove this limitation and create a truly distributed file system in XREF.)

Our file system consists of directories and files. Directories are containers that can contain either directories or files, meaning that the file system is hierarchical. A dedicated directory is at the root of the file system. Each directory and file has a name. Files and directories with a common parent directory must have different names (but files and directories with different parent directories can have the same name). In other words, directories form a naming scope, and entries with a single directory must have unique names. Directories allow you to list their contents.

For now, we do not have a concept of pathnames, or the creation and destruction of files and directories. Instead, the server provides a fixed number of directories and files. (We will address the creation and destruction of files and directories in XREF.)

Files can be read and written but, for now, reading and writing always replace the entire contents of a file; it is impossible to read or write only parts of a file.

5.3 Slice Definitions for the File System

Given the very simple requirements we just outlined, we can start designing interfaces for the system. Files and directories have something in common: they have a name and both files and directories can be contained in directories. This suggests a design that uses a base type that provides the common functionality, and derived

types that provide the functionality specific to directories and files, as shown in Figure 5.1.

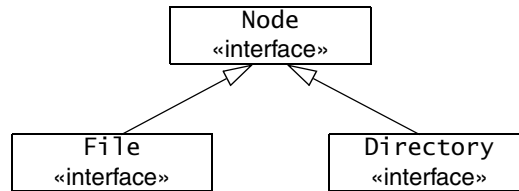

Figure 5.1. Inheritance Diagram of the File System.

The Slice definitions for this look as follows:

```

interface Node {
    // ...
};

interface File extends Node {
    // ...
};

interface Directory extends Node {
    // ...
};
  
```

Next, we need to think about what operations should be provided by each interface. Seeing that directories and files have names, we can add an operation to obtain the name of a directory or file to the Node base interface:

```

interface Node {
    nonmutating string name();
};
  
```

The File interface provides operations to read and write a file. For the time being, we limit ourselves to text files (see XREF for a discussion of dealing with binary files). For simplicity, we assume that read operations never fail and that only write operations can encounter error conditions. This leads to the following definitions:

```

exception GenericError {
    string reason;
};

sequence<string> Lines;
  
```

```
interface File extends Node {
    nonmutating Lines read();
    idempotent void write (Lines text) throws GenericError;
};
```

Note that `read` is marked as `nonmutating` because the operation does not modify the state of a file. The `write` operation is marked as `idempotent` because it replaces the entire contents of a file with what is passed in the `text` parameter. This means that it is safe to call the operation with the same parameter value twice in a row: the net result of doing so is the same as having (successfully) called the operation only once.

The `write` operation can raise an exception of type `GenericError`. The exception contains a single `reason` data member, of type `string`. If a `write` operation fails for some reason (such as running out of file system space), the operation throws a `GenericError` exception, with an explanation of the cause of the failure provided in the `reason` data member.

Directories provide an operation to list their contents. Because directories can contain both directories and files, we take advantage of the polymorphism provided by the `Node` base interface:

```
sequence<Node*> NodeSeq;

interface Directory extends Node {
    nonmutating NodeSeq list();
};
```

The `NodeSeq` sequence contains elements of type `Node*`. Because `Node` is a base interface of both `Directory` and `File`, the `NodeSeq` sequence can contain proxies of either type. (Obviously, the receiver of a `NodeSeq` must down-cast each element to either `File` or `Directory` in order to get at the operations provided by the derived interfaces; only the `name` operation in the `Node` base interface can be invoked directly, without doing a down-cast first. Note that, because the elements of `NodeSeq` are of type `Node*` (not `Node`), we are using pass-by-reference semantics: the values returned by the `list` operation are proxies that each point to a remote node on the server.

These definitions are sufficient to build a simple (but functional) file system. Obviously, there are still some unanswered questions, such as how a client obtains the proxy for the root directory. We will address these questions in XREF.

5.4 The Complete Definition

To avoid polluting the global namespace, we wrap our definitions in a module, resulting in the final definition as follows:

```
module Filesystem {
    interface Node {
        nonmutating string name();
    };

    exception GenericError {
        string reason;
    };

    sequence<string> Lines;

    interface File extends Node {
        nonmutating Lines read();
        idempotent void write(Lines text) throws GenericError;
    };

    sequence<Node*> NodeSeq;

    interface Directory extends Node {
        nonmutating NodeSeq list();
    };

    interface Filesys {
        nonmutating Directory* getRoot();
    };
};
```

Part III

Language Mappings

Part III.A

C++ Mapping

Chapter 6

Client-Side Slice-to-C++ Mapping

6.1 Chapter Overview

In this chapter, we present the client-side Slice-to-C++ mapping (see Chapter 8 for the server-side mapping). One part of the client-side C++ mapping concerns itself with rules for representing each Slice data type as a corresponding C++ type; we cover these rules in Section 6.3 to Section 6.10. Another part of the mapping deals with how clients can invoke operations, pass and receive parameters, and handle exceptions. These topics are covered in Section 6.11 to Section 6.13. Slice classes have the characteristics of both data types and interfaces and are covered in Section 6.14. Finally, we conclude the chapter with a brief comparison of the Slice-to-C++ mapping with the CORBA C++ mapping.

6.2 Introduction

The client-side Slice-to-C++ mapping defines how Slice data types are translated to C++ types, and how clients invoke operations, pass parameters, and handle errors. Much of the C++ mapping is intuitive. For example, Slice sequences map to STL vectors, so there is essentially nothing new you have learn in order to use Slice sequences in C++.

The rules that make up the C++ mapping are simple and regular. In particular, the mapping is free from the potential pitfalls of memory management: all types are self-managed and automatically clean up when instances go out of scope. This means that you cannot accidentally introduce a memory leak by, for example, ignoring the return value of an operation invocation or forgetting to deallocate memory that was allocated by a called operation.

The C++ mapping is fully thread-safe. For example, the reference counting mechanism for classes (see Section 6.14.6) is interlocked against parallel access, so reference counts cannot be corrupted if a class instance is shared among a number of threads. Obviously, you must still synchronize access to data from different threads. For example, if you have two threads sharing a sequence, you cannot safely have one thread insert into the sequence while another thread is iterating over the sequence. However, you only need to concern yourself with concurrent access to your own data—the Ice run time itself is fully thread safe, and none of the Ice API calls require you to acquire or release a lock before you safely can make the call.

Much of what appears in this chapter is reference material. We suggest that you skim the material on the initial reading and refer back to specific sections as needed. However, we recommend that you read at least Section 6.9 to Section 6.13 in detail because these sections cover how to call operations from a client, pass parameters, and handle exceptions.

A word of advice before you start: in order to use the C++ mapping, you should need no more than the Slice definition of your application and knowledge of the C++ mapping rules. In particular, looking through the generated header files in order to discern how to use the C++ mapping is likely to be confusing because the header files are not necessarily meant for human consumption and, occasionally, contain various cryptic constructs to deal with operating system and compiler idiosyncrasies. Of course, occasionally, you may want to refer to a header file to confirm a detail of the mapping, but we recommend that you otherwise use the material presented here to see how to write your client-side code.

6.3 Mapping for Identifiers

Slice identifiers map to an identical C++ identifier. For example, the Slice identifier `Clock` becomes the C++ identifier `Clock`. There is one exception to this rule: if a Slice identifier is the same as a C++ keyword, the corresponding C++ identi-

fier is prefixed with `_cpp_`. For example, the Slice identifier `while` is mapped as `_cpp_while`.¹

A single Slice identifier often results in several C++ identifiers. For example, for a Slice interface named `Foo`, the generated C++ code uses the identifiers `Foo` and `FooPrx` (among others). If the interface has the name `while`, the generated identifiers are `_cpp_while` and `whilePrx` (*not* `_cpp_whilePrx`), that is, the prefix is applied only to those generated identifiers that actually require it.

6.4 Mapping for Modules

Slice modules map to C++ namespaces. The mapping preserves the nesting of the Slice definitions. For example:

```
module M1 {
    module M2 {
        // ...
    };
    // ...
};

// ...

module M1 {      // Reopen M1
    // ...
};
```

This definition maps to the corresponding C++ definition:

```
namespace M1 {
    namespace M2 {
        // ...
    }
    // ...
}

// ...
```

1. As suggested in Section 4.5.3 on page 86, you should try to avoid such identifiers as much as possible.

```
namespace M1 { // Reopen M1
    // ...
}
```

If a Slice module is reopened, the corresponding C++ namespace is reopened as well.

6.5 The Ice Namespace

All of the APIs for the Ice run time are nested in the Ice namespace, to avoid clashes with definitions for other libraries or applications. Some of the contents of the Ice namespace are generated from Slice definitions; other parts of the Ice namespace provide special-purpose definitions that do not have a corresponding Slice definition. We will incrementally cover the contents of the Ice namespace throughout the remainder of the book.

6.6 Mapping for Simple Built-In Types

The Slice built-in types are mapped to C++ types as shown in Table 6.1.

Table 6.1. Mapping of Slice built-in types to C++.

Slice	C++
bool	bool
byte	Ice::Byte
short	Ice::Short
int	Ice::Int
long	Ice::Long
float	Ice::Float
double	Ice::Double

Table 6.1. Mapping of Slice built-in types to C++.

Slice	C++
string	std::string

Slice `bool` and `string` map to C++ `bool` and `std::string`. The remaining built-in Slice types map to C++ type definitions instead of C++ native types. This allows the Ice run time to provide a definition as appropriate for each target architecture. (For example, `Ice::Int` might be defined as `long` on one architecture and as `int` on another.)

Note that `Ice::Byte` is a typedef for `unsigned char`. This guarantees that byte values are always in the range 0..255.

All the basic types are guaranteed to be distinct C++ types, that is, you can safely overload functions that differ in only the types in Table 6.1.

6.6.1 Alternate String Mapping

You can use a metadata directive, `["cpp:type:wstring"]`, to map strings to C++ `std::wstring`. This is useful for applications that use languages with alphabets that cannot be represented in 8-bit characters. The metadata directive can be applied to any Slice construct. For containers (such as modules, interfaces, or structures), the metadata directive applies to all strings within the container. A corresponding metadata directive, `["cpp:type:string"]` can be used to selectively override the mapping defined by the enclosing container. For example:

```
["cpp:type:wstring"]
struct S1 {
    string x;           // Maps to std::wstring
    ["cpp:type:wstring"]
    string y;         // Maps to std::wstring
    ["cpp:type:string"]
    string z;         // Maps to std::string
};

struct S2 {
    string x;         // Maps to std::string
    ["cpp:type:string"]
```

```
    string y;           // Maps to std::string
    ["cpp:type:wstring"]
    string z;          // Maps to std::wstring
};
```

With these metadata directives, the strings are mapped as indicated by the comments. By default, narrow strings are encoded as UTF-8, and wide strings use Unicode in an encoding that is appropriate for the platform on which the application executes. You can override the encoding for narrow and wide strings by registering a string converter with the Ice run time. (See Section 31.21 for details.)

6.7 Mapping for User-Defined Types

Slice supports user-defined types: enumerations, structures, sequences, and dictionaries.

6.7.1 Mapping for Enumerations

Enumerations map to the corresponding enumeration in C++. For example:

```
enum Fruit { Apple, Pear, Orange };
```

Not surprisingly, the generated C++ definition is identical:

```
enum Fruit { Apple, Pear, Orange };
```

6.7.2 Mapping for Structures

Slice structures map to C++ structures with the same name. For each Slice data member, the C++ structure contains a public data member. For example, here is our `Employee` structure from Section 4.9.4 once more:

```
struct Employee {
    long number;
    string firstName;
    string lastName;
};
```

The Slice-to-C++ compiler generates the following definition for this structure:

```
struct Employee {
    Ice::Long    number;
    std::string firstName;
    std::string lastName;
    bool operator==(const Employee&) const;
    bool operator!=(const Employee&) const;
    bool operator<(const Employee&) const;
    bool operator<=(const Employee&) const;
    bool operator>(const Employee&) const;
    bool operator>=(const Employee&) const;
};
```

For each data member in the Slice definition, the C++ structure contains a corresponding public data member of the same name.

Note that the structure also contains comparison operators. These operators have the following behavior:

- `operator==`
Two structures are equal if (recursively), all its members are equal.
- `operator!=`
Two structures are not equal if (recursively), one or more of its members are not equal.
- `operator<`
`operator<=`
`operator>`
`operator>=`

The comparison operators treat the members of a structure as sort order criteria: the first member is considered the first criterion, the second member the second criterion, and so on. Assuming that we have two `Employee` structures, `s1` and `s2`, this means that the generated code uses the following algorithm to compare `s1` and `s2`:

```
bool Employee::operator<(const Employee& rhs) const
{
    if (this == &rhs)    // Short-cut self-comparison
        return false;

    // Compare first members
    //
    if (number < rhs.number)
        return true;
    else if (rhs.number < number)
        return false;
```

```
    // First members are equal, compare second members
    //
    if (firstName < rhs.firstName)
        return true;
    else if (rhs.firstName < firstName)
        return false;

    // Second members are equal, compare third members
    //
    if (lastName < rhs.lastName)
        return true;
    else if (rhs.lastName < lastName)
        return false;

    // All members are equal, so return false
    return false;
}
```

The comparison operators are provided to allow the use of structures as the key type of Slice dictionaries, which are mapped to `std::map` in C++ (see Section 6.7.5).

Note that copy construction and assignment always have deep-copy semantics. You can freely assign structures or structure members to each other without having to worry about memory management. The following code fragment illustrates both comparison and deep-copy semantics:

```
Employee e1, e2;
e1.firstName = "Bjarne";
e1.lastName = "Stroustrup";
e2 = e1; // Deep copy
assert(e1 == e2);
e2.firstName = "Andrew"; // Deep copy
e2.lastName = "Koenig"; // Deep copy
assert(e2 < e1);
```

Because strings are mapped to `std::string`, there are no memory management issues in this code and structure assignment and copying work as expected. (The default member-wise copy constructor and assignment operator generated by the C++ compiler do the right thing.)

6.7.3 Mapping for Sequences

Here is the definition of our `FruitPlatter` sequence from Section 4.9.3 once more:

```
sequence<Fruit> FruitPlatter;
```

The Slice compiler generates the following C++ definition for the `FruitPlatter` sequence:

```
typedef std::vector<Fruit> FruitPlatter;
```

As you can see, the sequence simply maps to an STL vector. As a result, you can use the sequence like any other STL vector, for example:

```
// Make a small platter with one Apple and one Orange
//
FruitPlatter p;
p.push_back(Apple);
p.push_back(Orange);
```

As you would expect, you can use all the usual STL iterators and algorithms with this vector.

6.7.4 Custom Sequence Mapping

In addition to the default mapping of sequences to vectors, Ice supports three additional custom mappings for sequences.

STL Container Mapping for Sequences

You can override the default mapping of Slice sequences to C++ vectors with a metadata directive, for example:

```
["cpp:include:list"]

module Food {

    enum Fruit { Apple, Pear, Orange };

    ["cpp:type:std::list< ::Food::Fruit>"]
    sequence<Fruit> FruitPlatter;

};
```

With this metadata directive, the sequence now maps to a C++ `std::list`:

```
#include <list>

namespace Food {

    typedef std::list< Food::Fruit> FruitPlatter;

    // ...
}
```

The `cpp:type` metadata directive must be applied to a sequence definition; anything following the `cpp:type:` prefix is taken to be the name of the type. For example, we could use `["cpp:type::std::list< ::Food::Fruit>"]`. In that case, the compiler would use a fully-qualified name to define the type:

```
typedef ::std::list< ::Food::Fruit> FruitPlatter;
```

Note that the code generator inserts whatever string you specify following the `cpp:type:` prefix literally into the generated code. This means that, to avoid C++ compilation failures due to unknown symbols, you should use a qualified name for the type.

Also note that, to avoid compilation errors in the generated code, you must instruct the compiler to generate an appropriate include directive with the `cpp:include` global metadata directive. This causes the compiler to add the line

```
#include <list>
```

to the generated header file.

Instead of `std::list`, you can specify a type of your own as the sequence type, for example:

```
["cpp:include:FruitBowl.h"]

module Food {

    enum Fruit { Apple, Pear, Orange };

    ["cpp:type:FruitBowl"]
    sequence<Fruit> FruitPlatter;

};
```

With these metadata directives, the compiler will use a C++ type `FruitBowl` as the sequence type, and add an include directive for the header file `FruitBowl.h` to the generated code.

You can use any class of your choice as a sequence type, but the class must meet certain requirements. (`vector`, `list`, and `deque` happen to meet these requirements.)

- The class must have a default constructor and a single-argument constructor that takes the size of the sequence as an argument of unsigned integral type.
- The class must have a copy constructor.
- The class must provide a member function `size` that returns the number elements in the sequence as an unsigned integral type.
- The class must provide a member function `swap` that swaps the contents of the sequence with another sequence of the same type.
- The class must define `iterator` and `const_iterator` types and must provide `begin` and `end` member functions with the usual semantics; the iterators must be comparable for equality and inequality.

Less formally, this means that if the class looks like a `vector`, `list`, or `deque` with respect to these points, you can use it as a custom sequence implementation.

In addition to modifying the type of a sequence itself, you can also modify the mapping for particular return values or parameters (see Section 6.12). For example:

```
["cpp:include:list"]
["cpp:include:deque"]

module Food {

    enum Fruit { Apple, Pear, Orange };

    sequence<Fruit> FruitPlatter;

    interface Market {
        ["cpp:type:list< ::Food::Fruit>"]
        FruitPlatter
        barter(
            ["cpp:type:deque< ::Food::Fruit>"] FruitPlatter offer
        );
    };
};
```

With this definition, the default mapping of `FruitPlatter` to a C++ `vector` still applies but the return value of `barter` is mapped as a `list`, and the `offer` parameter is mapped as a `deque`.

Array Mapping for Sequences

The array mapping for sequences applies to input parameters (see Section 6.12) and to out parameters of AMI and AMD operations (see Chapter 32). For example:

```
interface File {
    void write(["cpp:array"] Ice::ByteSeq contents);
};
```

The `cpp:array` metadata directive instructs the compiler to map the offer parameter to a pair of pointers:

```
virtual void write(const ::std::pair<const ::Ice::Byte*,
                               const ::Ice::Byte*>&,
                  const ::Ice::Current& = ::Ice::Current()) = 0;
```

The passed pointers denote the beginning and end of the sequence as a range [`first`, `last`) (that is, they use the usual STL semantics for iterators).

The array mapping is useful to achieve zero-copy passing of sequences. The pointers point directly into the server-side transport buffer; this allows the server-side run time to avoid creating a `vector` to pass to the operation implementation, thereby avoiding both allocating memory for the sequence and copying its contents into that memory.

Note that you can use the array mapping for any sequence type. However, it provides a performance advantage only for byte sequences (on all platforms) and for sequences of integral type (x86 platforms only).

Also note that the called operation in the server must not store a pointer into the passed sequence because the transport buffer into which the pointer points is deallocated as soon as the operation completes.

Range Mapping for Sequences

The range mapping for sequences is similar to the array mapping and exists for the same purpose, namely, to enable zero-copy of sequence parameters:

```
interface File {
    void write(["cpp:range"] Ice::ByteSeq contents);
};
```

The `cpp::range` metadata directive instructs the compiler to map the offer parameter to a pair of `const_iterator`:

```
virtual void write(const ::std::pair<
                  ::Ice::ByteSeq::const_iterator
                  ::Ice::ByteSeq::const_iterator>&,
                  const ::Ice::Current& = ::Ice::Current()) = 0;
```

The passed iterators denote the beginning and end of the sequence as a range `[first, last)` (that is, they use the usual STL semantics for iterators).

The motivation for the range mapping is the same as for the array mapping: the passed iterators point directly into the server-side transport buffer and so avoid the need to create a temporary `vector` to pass to the operation.

As for the array mapping, the range mapping can be used with any sequence type, but offers a performance advantage only for byte sequences (on all platforms) and for sequences of integral type (x86 platforms only).

The operation must not store an iterator into the passed sequence because the transport buffer into which the iterator points is deallocated as soon as the operation completes.

You can optionally add a type name to the `cpp:range` metadata directive, for example:

```
interface File {
    void write(
        ["cpp:range:std::deque<Ice::Byte>"]
        Ice::ByteSeq contents);
};
```

This instructs the compiler to generate a pair of `const_iterator` for the specified type:

```
virtual void write(const ::std::pair<
                  std::deque<Ice::Byte>::const_iterator
                  std::deque<Ice::Byte>::const_iterator>&,
                  const ::Ice::Current& = ::Ice::Current()) = 0;
```

This is useful if you want to combine the range mapping with a custom sequence type that behaves like an STL container.

6.7.5 Mapping for Dictionaries

Here is the definition of our `EmployeeMap` from Section 4.9.4 once more:

```
dictionary<long, Employee> EmployeeMap;
```

The following code is generated for this definition:

```
typedef std::map<Ice::Long, Employee> EmployeeMap;
```

Again, there are no surprises here: a Slice dictionary simply maps to an STL map. As a result, you can use the dictionary like any other STL map, for example:

```
EmployeeMap em;
Employee e;

e.number = 42;
e.firstName = "Stan";
e.lastName = "Lippman";
em[e.number] = e;

e.number = 77;
e.firstName = "Herb";
e.lastName = "Sutter";
em[e.number] = e;
```

Obviously, all the usual STL iterators and algorithms work with this map just as well as with any other STL container.

6.8 Mapping for Constants

Slice constant definitions map to corresponding C++ constant definitions. Here are the constant definitions we saw in Section 4.9.5 on page 97 once more:

```
const bool      AppendByDefault = true;
const byte      LowerNibble = 0x0f;
const string    Advice = "Don't Panic!";
const short     TheAnswer = 42;
const double    PI = 3.1416;

enum Fruit { Apple, Pear, Orange };
const Fruit     FavoriteFruit = Pear;
```

Here are the generated definitions for these constants:

```
const bool      AppendByDefault = true;
const Ice::Byte LowerNibble =      15;
const std::string Advice =          "Don't Panic!";
const Ice::Short TheAnswer =        42;
const Ice::Double PI =              3.1416;

enum Fruit { Apple, Pear, Orange };
const Fruit     FavoriteFruit =     Pear;
```

All constants are initialized directly in the header file, so they are compile-time constants and can be used in contexts where a compile-time constant expression is required, such as to dimension an array or as the case label of a switch statement.

6.9 Mapping for Exceptions

Here is a fragment of the Slice definition for our world time server from Section 4.10.5 on page 113 once more:

```
exception GenericError {
    string reason;
};
exception BadTimeVal extends GenericError {};
exception BadZoneName extends GenericError {};
```

These exception definitions map as follows:

```
class GenericError: public Ice::UserException {
public:
    std::string reason;

    GenericError() {}
    explicit GenericError(const string&);

    virtual const std::string& ice_name() const;
    virtual Ice::Exception* ice_clone() const;
    virtual void ice_throw() const;
    // Other member functions here...
};

class BadTimeVal: public GenericError {
public:
    BadTimeVal() {}
    explicit BadTimeVal(const string&);

    virtual const std::string& ice_name() const;
    virtual Ice::Exception* ice_clone() const;
    virtual void ice_throw() const;
    // Other member functions here...
};

class BadZoneName: public GenericError {
```

```

public:
    BadZoneName() {}
    explicit BadZoneName(const string&);

    virtual const std::string& ice_name() const;
    virtual Ice::Exception* ice_clone() const;
    virtual void ice_throw() const;
};

```

Each Slice exception is mapped to a C++ class with the same name. For each exception member, the corresponding class contains a public data member. (Obviously, because `BadTimeVal` and `BadZoneName` do not have members, the generated classes for these exceptions also do not have members.)

The inheritance structure of the Slice exceptions is preserved for the generated classes, so `BadTimeVal` and `BadZoneName` inherit from `GenericError`.

Each exception has three additional member functions:

- `ice_name`

As the name suggests, this member function returns the name of the exception. For example, if you call the `ice_name` member function of a `BadZoneName` exception, it (not surprisingly) returns the string `"BadZoneName"`. The `ice_name` member function is useful if you catch exceptions generically and want to produce a more meaningful diagnostic, for example:

```

try {
    // ...
} catch (const Ice::GenericError& e) {
    cerr << "Caught an exception: " << e.ice_name() << endl;
}

```

If an exception is raised, this code prints the name of the actual exception (`BadTimeVal` or `BadZoneName`) because the exception is being caught by reference (to avoid slicing).

- `ice_clone`

This member function allows you to polymorphically clone an exception. For example:

```

try {
    // ...
} catch (const Ice::UserException& e) {
    Ice::UserException* copy = e.clone();
}

```

```
}

```

`ice_clone` is useful if you need to make a copy of an exception without knowing its precise run-time type. This allows you to remember the exception and throw it later by calling `ice_throw`.

- `ice_throw`

`ice_throw` allows you to throw an exception without knowing its precise run-time type. It is implemented as:

```
void
GenericError::ice_throw() const
{
    throw *this;
}
```

You can call `ice_throw` to throw an exception that you previously cloned with `ice_clone`.

Each exception has a default constructor. This constructor performs memberwise initialization; for simple built-in types, such as integers, the constructor performs no initialization, whereas complex types, such as strings, sequences, and dictionaries are initialized by their respective default constructors.

An exception also has a second construct that accepts one argument for each exception member. This constructor allows you to instantiate and initialize an exception in a single statement, instead of having to first instantiate the exception and then assign to its members. (For derived exceptions, the constructor accepts one argument for each base exception member, plus one argument for each derived exception member, in base-to-derived order.)

Note that the generated exception classes contain other member functions that are not shown on page 195. However, those member functions are internal to the C++ mapping and are not meant to be called by application code.

All user exceptions ultimately inherit from `Ice::UserException`. In turn, `Ice::UserException` inherits from `Ice::Exception` (which is an alias for `IceUtil::Exception`):

```
namespace IceUtil {
    class Exception {
        virtual const std::string& ice_name() const;
        Exception* ice_clone() const;
        void ice_throw() const;
        virtual void ice_print(std::ostream&) const;
        // ...
    };
}
```

```

        std::ostream& operator<<(std::ostream&, const Exception&);
        // ...
    }

namespace Ice {
    typedef IceUtil::Exception Exception;

    class UserException: public Exception {
    public:
        virtual const std::string& ice_name() const = 0;
        // ...
    };
}

```

`Ice::Exception` forms the root of the exception inheritance tree. Apart from the usual `ice_name`, `ice_clone`, and `ice_throw` member functions, it contains the `ice_print` member functions. `ice_print` prints the name of the exception. For example, calling `ice_print` on a `BadTimeVal` exception prints:

```
BadTimeVal
```

To make printing more convenient, `operator<<` is overloaded for `Ice::Exception`, so you can also write:

```

try {
    // ...
} catch (const Ice::Exception& e) {
    cerr << e << endl;
}

```

This produces the same output because `operator<<` calls `ice_print` internally.

For Ice run time exceptions, `ice_print` also shows the file name and line number at which the exception was thrown.

6.10 Mapping for Run-Time Exceptions

The Ice run time throws run-time exceptions for a number of pre-defined error conditions. All run-time exceptions directly or indirectly derive from `Ice::LocalException` (which, in turn, derives from `Ice::Exception`). `Ice::LocalException` has the usual member functions (`ice_name`,

`ice_clone`, `ice_throw`, and (inherited from `Ice::Exception`), `ice_print`, `ice_file`, and `ice_line`).

An inheritance diagram for user and run-time exceptions appears in Figure 4.4 on page 110. By catching exceptions at the appropriate point in the hierarchy, you can handle exceptions according to the category of error they indicate. For example, a `ConnectTimeoutException` can be handled as any one of the following exception types:

- `Ice::Exception`
This is the root of the complete inheritance tree. Catching `Ice::Exception` catches both user and run-time exceptions.
- `Ice::UserException`
This is the root exception for all user exceptions. Catching `Ice::UserException` catches all user exceptions (but not run-time exceptions).
- `Ice::LocalException`
This is the root exception for all run-time exceptions. Catching `Ice::LocalException` catches all run-time exceptions (but not user exceptions).
- `Ice::TimeoutException`
This is the base exception for both operation-invocation and connection-establishment timeouts.
- `Ice::ConnectTimeoutException`
This exception is raised when the initial attempt to establish a connection to a server times out.

You will probably have little need to catch exceptions by category; the fine-grained error handling offered by the remainder of the hierarchy is of interest mainly in the implementation of the Ice run time.

6.11 Mapping for Interfaces

The mapping of Slice interfaces revolves around the idea that, to invoke a remote operation, you call a member function on a local class instance that represents the remote object. This makes the mapping easy and intuitive to use because, for all intents and purposes (apart from error semantics), making a remote procedure call is no different from making a local procedure call.

6.11.1 Proxy Classes and Proxy Handles

On the client side, interfaces map to classes with member functions that correspond to the operations on those interfaces. Consider the following simple interface:

```
module M {
    interface Simple {
        void op();
    }
};
```

The Slice compiler generates the following definitions for use by the client:

```
namespace IceProxy {
    namespace M {
        class Simple;
    }
}

namespace M {
    class Simple;
    typedef IceInternal::ProxyHandle< ::IceProxy::M::Simple>
        SimplePrx;
    typedef IceInternal::Handle< ::M::Simple> SimplePtr;
}

namespace IceProxy {
    namespace M {
        class Simple : public virtual IceProxy::Ice::Object {
        public:
            typedef ::M::SimplePrx ProxyType;
            typedef ::M::SimplePtr PointerType;

            void op();
            void op(const Ice::Context&);
            // ...
        };
    };
}
```

As you can see, the compiler generates a *proxy class* `Simple` in the `IceProxy::M` namespace, as well as a *proxy handle* `M::SimplePrx`. In general, for a module `M`, the generated names are `::IceProxy::M::<intf-name>` and `::M::<intf-name>Prx`.

In the client's address space, an instance of `IceProxy::M::Simple` is the local ambassador for a remote instance of the `Simple` interface in a server and is known as a *proxy class instance*. All the details about the server-side object, such as its address, what protocol to use, and its object identity are encapsulated in that instance.

Note that `Simple` inherits from `IceProxy::Ice::Object`. This reflects the fact that all `Ice` interfaces implicitly inherit from `Ice::Object`. For each operation in the interface, the proxy class has two overloaded member functions of the same name. For the preceding example, we find that the operation `op` has been mapped to two member functions `op`.

One of the overloaded member functions has a trailing parameter of type `Ice::Context`. This parameter is for use by the `Ice` run time to store information about how to deliver a request; normally, you do not need to supply a value here and can pretend that the trailing parameter does not exist. (We examine the `Ice::Context` parameter in detail in Chapter 31. The parameter is also used by `IceStorm`—see Chapter 43.)

Client-side application code never manipulates proxy class instances directly. In fact, you are not allowed to instantiate a proxy class directly. The following code will not compile because `Ice::Object` is an abstract base class with a protected constructor and destructor:

```
IceProxy::M::Simple s; // Compile-time error!
```

Proxy instances are always instantiated on behalf of the client by the `Ice` run time, so client code never has any need to instantiate a proxy directly. When the client receives a proxy from the run time, it is given a *proxy handle* to the proxy, of type `<interface-name>Prx` (`SimplePrx` for the preceding example). The client accesses the proxy via its proxy handle; the handle takes care of forwarding operation invocations to its underlying proxy, as well as reference-counting the proxy. This means that no memory-management issues can arise: deallocation of a proxy is automatic and happens once the last handle to the proxy disappears (goes out of scope).

Because the application code always uses proxy handles and never touches the proxy class directly, we usually use the term *proxy* to denote both proxy handle and proxy class. This reflects the fact that, in actual use, the proxy handle looks and feels like the underlying proxy class instance. If the distinction is important, we use the terms *proxy class*, *proxy class instance*, and *proxy handle*.

Also note that the generated proxy class contains type definitions for `ProxyType` and `PointerType`. These are provided so you can refer to the proxy type

and smart pointer type (see Section 6.14.6) in template definitions without having to resort to preprocessor trickery, for example:

```
template<typename T>
class ProxyWrapper {
public:
    T::ProxyType proxy() const;
    // ...
};
```

6.11.2 Methods on Proxy Handles

As we saw for the preceding example, the handle is actually a template of type `IceInternal::ProxyHandle` that takes the proxy class as the template parameter. This template has the usual constructor, copy constructor, and assignment operator:

- Default constructor

You can default-construct a proxy handle. The default constructor creates a proxy that points nowhere (that is, points at no object at all.) If you invoke an operation on such a null proxy, you get an `IceUtil::NullHandleException`:

```
try {
    SimplePrx s;           // Default-constructed proxy
    s->op();               // Call via nil proxy
    assert(0);           // Can't get here
} catch (const IceUtil::NullHandleException&) {
    cout << "As expected, got a NullHandleException" << endl;
}
```

- Copy constructor

The copy constructor ensures that you can construct a proxy handle from another proxy handle. Internally, this increments a reference count on the proxy; the destructor decrements the reference count again and, once the count drops to zero, deallocates the underlying proxy class instance. That way, memory leaks are avoided:

```
{
    SimplePrx s1 = ...;   // Enter new scope
    SimplePrx s2(s1);    // Get a proxy from somewhere
    assert(s1 == s2);    // Copy-construct s2
                        // Assertion passes
}                        // Leave scope; s1, s2, and the
                        // underlying proxy instance
```



```
// are deallocated
```

Note the assertion in this example: proxy handles support comparison (see Section 6.11.3).

- Assignment operator

You can freely assign proxy handles to each other. The handle implementation ensures that the appropriate memory-management activities take place. Self-assignment is safe and you do not have to guard against it:

```
SimplePrx s1 = ...;    // Get a proxy from somewhere
SimplePrx s2;        // s2 is nil
s2 = s1;             // both point at the same object
s1 = 0;              // s1 is nil
s2 = 0;              // s2 is nil
```

Widening assignments work implicitly. For example, if we have two interfaces, Base and Derived, we can widen a DerivedPrx to a BasePrx implicitly:

```
BasePrx base;
DerivedPrx derived;
base = derived;      // Fine, no problem
derived = base;     // Compile-time error
```

Implicit narrowing conversions result in a compile error, so the usual C++ semantics are preserved: you can always assign a derived type to a base type, but not vice versa.

- Checked cast

Proxy handles provide a checkedCast method:

```
namespace IceInternal {
    template<typename T>
    class ProxyHandle : public IceUtil::HandleBase<T> {
    public:
        template<class Y>
        static ProxyHandle checkedCast(const ProxyHandle<Y>& r);

        template<class Y>
        static ProxyHandle checkedCast(const ProxyHandle<Y>& r,
                                       const ::Ice::Context& c);

        // ...
    };
```

```
}

```

A checked cast has the same function for proxies as a C++ `dynamic_cast` has for pointers: it allows you to assign a base proxy to a derived proxy. If the base proxy's actual run-time type is compatible with the derived proxy's static type, the assignment succeeds and, after the assignment, the derived proxy denotes the same object as the base proxy. Otherwise, if the base proxy's run-time type is incompatible with the derived proxy's static type, the derived proxy is set to null. Here is an example to illustrate this:

```
BasePrx base = ...;      // Initialize base proxy
DerivedPrx derived;
derived = DerivedPrx::checkedCast(base);
if (derived) {
    // Base has run-time type Derived,
    // use derived...
} else {
    // Base has some other, unrelated type
}

```

The expression `DerivedPrx::checkedCast(base)` tests whether `base` points at an object of type `Derived` (or an object with a type that is derived from `Derived`). If so, the cast succeeds and `derived` is set to point at the same object as `base`. Otherwise, the cast fails and `derived` is set to the null proxy.

Note that `checkedCast` is a static member function so, to do a down-cast, you always use the syntax `<interface-name>Prx::checkedCast`.

Also note that you can use proxies in boolean contexts. For example, `if (proxy)` returns true if the proxy is not null (see Section 6.11.3).

A `checkedCast` typically results in a remote message to the server.² The message effectively asks the server “is the object denoted by this reference of type `Derived`?” The reply from the server is communicated to the application code in form of a successful (non-null) or unsuccessful (null) result. Sending a remote message is necessary because, as a rule, there is no way for the client to find out what the actual run-time type of a proxy is without confirmation from the server. (For example, the server may replace the implementation of

2. In some cases, the Ice run time can optimize the cast and avoid sending a message. However, the optimization applies only in narrowly-defined circumstances, so you cannot rely on a `checkedCast` not sending a message.

the object for an existing proxy with a more derived one.) This means that you have to be prepared for a `checkedCast` to fail. For example, if the server is not running, you will receive a `ConnectFailedException`; if the server is running, but the object denoted by the proxy no longer exists, you will receive an `ObjectNotExistException`.

- Unchecked cast

In some cases, it is known that an object supports a more derived interface than the static type of its proxy. For such cases, you can use an unchecked down-cast:

```
namespace IceInternal {
    template<typename T>
    class ProxyHandle : public IceUtil::HandleBase<T> {
    public:
        template<class Y>
        static ProxyHandle uncheckedCast(const ProxyHandle<Y>& r);
        // ...
    };
}
```

An `uncheckedCast` provides a down-cast *without* consulting the server as to the actual run-time type of the object, for example:

```
BasePrx base = ...; // Initialize to point at a Derived
DerivedPrx derived;
derived = DerivedPrx::uncheckedCast(base);
// Use derived...
```

You should use an `uncheckedCast` only if you are certain that the proxy indeed supports the more derived type: an `uncheckedCast`, as the name implies, is not checked in any way; it does not contact the object in the server and, if it fails, it does not return null. (An unchecked cast is implemented internally like a C++ `static_cast`, no checks of any kind are made). If you use the proxy resulting from an incorrect `uncheckedCast` to invoke an operation, the behavior is undefined. Most likely, you will receive an `ObjectNotExistException` or `OperationNotExistException`, but, depending on the circumstances, the Ice run time may also report an exception indicating that unmarshaling has failed, or even silently return garbage results.

Despite its dangers, `uncheckedCast` is still useful because it avoids the cost of sending a message to the server. And, particularly during initialization (see Chapter 7), it is common to receive a proxy of static type

`Ice::Object`, but with a known run-time type. In such cases, an `uncheckedCast` saves the overhead of sending a remote message.

For convenience, proxy handles also support insertion of a proxy into a stream, for example:

```
Ice::ObjectPrx p = ...;
cout << p << endl;
```

This code is equivalent to writing:

```
Ice::ObjectPrx p = ...;
cout << p->ice_toString() << endl;
```

Either code prints the stringified proxy (see Appendix D). You could also achieve the same thing by writing:

```
Ice::ObjectPrx p = ...;
cout << communicator->proxyToString(p) << endl;
```

The advantage of using the `ice_toString` member function instead of `proxyToString` is that you do not need to have the communicator available at the point of call.

6.11.3 Object Identity and Proxy Comparison

Apart from the methods discussed in Section 6.11.2, proxy handles also support comparison. Specifically, the following operators are supported:

- `operator==`
`operator!=`

These operators permit you to compare proxies for equality and inequality. To test whether a proxy is null, use a comparison with the literal `0`, for example:

```
if (proxy == 0)
    // It's a nil proxy
else
    // It's a non-nil proxy
```

- `operator<`
`operator<=`
`operator>`
`operator>=`

Proxies support comparison. This allows you to place proxies into STL containers such as maps or sorted lists.

- Boolean comparison

Proxies have a conversion operator to `bool`. The operator returns true if a proxy is not null, and false otherwise. This allows you to write:

```
BasePrx base = ...;
if (base)
    // It's a non-nil proxy
else
    // It's a nil proxy
```

Note that proxy comparison uses *all* of the information in a proxy for the comparison. This means that not only the object identity must match for a comparison to succeed, but other details inside the proxy, such as the protocol and endpoint information, must be the same. In other words, comparison with `==` and `!=` tests for *proxy* identity, *not* object identity. A common mistake is to write code along the following lines:

```
Ice::ObjectPrx p1 = ...;           // Get a proxy...
Ice::ObjectPrx p2 = ...;           // Get another proxy...

if (p1 != p2) {
    // p1 and p2 denote different objects      // WRONG!
} else {
    // p1 and p2 denote the same object        // Correct
}
```

Even though `p1` and `p2` differ, they may denote the same Ice object. This can happen because, for example, both `p1` and `p2` embed the same object identity, but each use a different protocol to contact the target object. Similarly, the protocols may be the same, but denote different endpoints (because a single Ice object can be contacted via several different transport endpoints). In other words, if two proxies compare equal with `==`, we know that the two proxies denote the same object (because they are identical in all respects); however, if two proxies compare unequal with `==`, we know absolutely nothing: the proxies may or may not denote the same object.

To compare the object identities of two proxies, you must use a helper function in the `Ice` namespace:

```
namespace Ice {

    bool proxyIdentityLess(const ObjectPrx&,
                           const ObjectPrx&);
```

```

        bool proxyIdentityEqual(const ObjectPrx&,
                               const ObjectPrx&);
    }

```

The `proxyIdentityEqual` function returns true if the object identities embedded in two proxies are the same and ignores other information in the proxies, such as facet and transport information. The `proxyIdentityLess` function establishes a total ordering on proxies. It is provided mainly so you can use object identity comparison with STL sorted containers. (The function uses name as the major ordering criterion, and category as the minor ordering criterion.)

`proxyIdentityEqual` allows you to correctly compare proxies for object identity:

```

Ice::ObjectPrx p1 = ...;           // Get a proxy...
Ice::ObjectPrx p2 = ...;           // Get another proxy...

if (!Ice::proxyIdentityEqual(p1, p2) {
    // p1 and p2 denote different objects           // Correct
} else {
    // p1 and p2 denote the same object             // Correct
}

```

6.12 Mapping for Operations

As we saw in Section 6.11, for each operation on an interface, the proxy class contains a corresponding member function with the same name. To invoke an operation, you call it via the proxy handle. For example, here is part of the definitions for our file system from Section 5.4:

```

module Filesystem {
    interface Node {
        nonmutating string name();
    };
    // ...
};

```

The proxy class for the `Node` interface, tidied up to remove irrelevant detail, is as follows:

```

namespace IceProxy {
    namespace Filesystem {
        class Node : virtual public IceProxy::Ice::Object {
        public:
            std::string name();
            // ...
        };
        typedef IceInternal::ProxyHandle<Node> NodePrx;
        // ...
    }
    // ...
}

```

The name operation returns a value of type `string`. Given a proxy to an object of type `Node`, the client can invoke the operation as follows:

```

NodePrx node = ...;           // Initialize proxy
string name = node->name();    // Get name via RPC

```

The proxy handle overloads `operator->` to forward method calls to the underlying proxy class instance which, in turn, sends the operation invocation to the server, waits until the operation is complete, and then unmarshals the return value and returns it to the caller.

Because the return value is of type `string`, it is safe to ignore the return value. For example, the following code contains no memory leak:

```

NodePrx node = ...;           // Initialize proxy
node->name();                  // Useless, but no leak

```

This is true for all mapped Slice types: you can safely ignore the return value of an operation, no matter what its type—return values are always returned by value. If you ignore the return value, no memory leak occurs because the destructor of the returned value takes care of deallocating memory as needed.

6.12.1 Normal, idempotent, and nonmutating Operations

You can add an idempotent or nonmutating qualifier to a Slice operation. As far as the signature for the corresponding proxy methods is concerned, neither `idempotent` nor `nonmutating` have any effect. For example, consider the following interface:

```
interface Example {
    string op1();
    idempotent string op2();
    nonmutating string op3();
};
```

The proxy class for this interface looks like this:

```
namespace IceProxy {
    class Example : virtual public IceProxy::Ice::Object {
    public:
        std::string op1();
        std::string op2();           // idempotent
        std::string op3();           // nonmutating
        // ...
    };
}
```

Because `idempotent` and `nonmutating` affect an aspect of call dispatch, not interface, it makes sense for the three methods to look the same.

6.12.2 Passing Parameters

In-Parameters

The parameter passing rules for the C++ mapping are very simple: parameters are passed either by value (for small values) or by `const` reference (for values that are larger than a machine word). Semantically, the two ways of passing parameters are identical: it is guaranteed that the value of a parameter will not be changed by the invocation (with some caveats—see page 213).

Here is an interface with operations that pass parameters of various types from client to server:

```
struct NumberAndString {
    int x;
    string str;
};

sequence<string> StringSeq;

dictionary<long, StringSeq> StringTable;

interface ClientToServer {
```



```

    void op1(int i, float f, bool b, string s);
    void op2(NumberAndString ns, StringSeq ss, StringTable st);
    void op3(ClientToServer* proxy);
};

```

The Slice compiler generates the following code for this definition:

```

struct NumberAndString {
    Ice::Int x;
    std::string str;
    // ...
};

typedef std::vector<std::string> StringSeq;

typedef std::map<Ice::Long, StringSeq> StringTable;

namespace IceProxy {
    class ClientToServer : virtual public IceProxy::Ice::Object {
    public:
        void op1(Ice::Int, Ice::Float, bool, const std::string&);
        void op2(const NumberAndString&,
                const StringSeq&,
                const StringTable&);
        void op3(const ClientToServerPrx&);
        // ...
    };
}

```

Given a proxy to a `ClientToServer` interface, the client code can pass parameters as in the following example:

```

ClientToServerPrx p = ...;           // Get proxy...

p->op1(42, 3.14, true, "Hello world!"); // Pass simple literals

int i = 42;
float f = 3.14;
bool b = true;
string s = "Hello world!";
p->op1(i, f, b, s);                   // Pass simple variables

NumberAndString ns = { 42, "The Answer" };
StringSeq ss;
ss.push_back("Hello world!");
StringTable st;

```

```

st[0] = ss;
p->op2(ns, ss, st);           // Pass complex variables

p->op3(p);                     // Pass proxy

```

You can pass either literals or variables to the various operations. Because everything is passed by value or `const` reference, there are no memory-management issues to consider.

out-Parameters

The C++ mapping passes out-parameters by reference. Here is the Slice definition from page 210 once more, modified to pass all parameters in the out direction:

```

struct NumberAndString {
    int x;
    string str;
};

sequence<string> StringSeq;

dictionary<long, StringSeq> StringTable;

interface ServerToClient {
    void op1(out int i, out float f, out bool b, out string s);
    void op2(out NumberAndString ns,
             out StringSeq ss,
             out StringTable st);
    void op3(out ServerToClient* proxy);
};

```

The Slice compiler generates the following code for this definition:

```

namespace IceProxy {
    class ServerToClient : virtual public IceProxy::Ice::Object {
    public:
        void op1(Ice::Int&, Ice::Float&, bool&, std::string&);
        void op2(NumberAndString&, StringSeq&, StringTable&);
        void op3(ServerToClientPrx&);
        // ...
    };
}

```

Given a proxy to a `ServerToClient` interface, the client code can pass parameters as in the following example:

```

ServerToClientPrx p = ...;          // Get proxy...

int i;
float f;
bool b;
string s;

p->op1(i, f, b, s);
// i, f, b, and s contain updated values now

NumberAndString ns;
StringSeq ss;
StringTable st;

p->op2(ns, ss, st);
// ns, ss, and st contain updated values now

p->op3(p);
// p has changed now!

```

Again, there are no surprises in this code: the caller simply passes variables to an operation; once the operation completes, the values of those variables will be set by the server.

It is worth having another look at the final call:

```
p->op3(p);          // Weird, but well-defined
```

Here, `p` is the proxy that is used to dispatch the call. That same variable `p` is also passed as an out-parameter to the call, meaning that the server will set its value. In general, passing the same parameter as both an input and output parameter is safe: the Ice run time will correctly handle all locking and memory-management activities.

Another, somewhat pathological example is the following:

```

sequence<int> Row;
sequence<Row> Matrix;

interface MatrixArithmetic {
    void multiply(Matrix m1,
                  Matrix m2,
                  out Matrix result);
};

```

Given a proxy to a `MatrixArithmetic` interface, the client code could do the following:

```

MatrixArithmeticPrx ma = ...;           // Get proxy...
Matrix m1 = ...;                       // Initialize one matrix
Matrix m2 = ...;                       // Initialize second matrix
ma->squareAndCubeRoot(m1, m2, m1); // !!!

```

This code is technically legal, in the sense that no memory corruption or locking issues will arise, but it has surprising behavior: because the same variable `m1` is passed as an input parameter as well as an output parameter, the final value of `m1` is indeterminate—in particular, if client and server are collocated in the same address space, the implementation of the operation will overwrite parts of the input matrix `m1` in the process of computing the result because the result is written to the same physical memory location as one of the inputs. In general, you should take care when passing the same variable as both an input and output parameter and only do so if the called operation guarantees to be well-behaved in this case.

Chained Invocations

Consider the following simple interface containing two operations, one to set a value and one to get it:

```

interface Name {
    string getName();
    void setName(string name);
};

```

Suppose we have two proxies to interfaces of type `Name`, `p1` and `p2`, and chain invocations as follows:

```
p2->setName(p1->getName());
```

This works exactly as intended: the value returned by `p1` is transferred to `p2`. There are no memory-management or exception safety issues with this code.³

6.13 Exception Handling

Any operation invocation may throw a run-time exception (see Section 6.10 on page 198) and, if the operation has an exception specification, may also throw

3. This is worth pointing out because, in CORBA, the equivalent code leaks memory (as does ignoring the return value in many cases).

user exceptions (see Section 6.9 on page 195). Suppose we have the following simple interface:

```
exception Tantrum {
    string reason;
};

interface Child {
    void askToCleanUp() throws Tantrum;
};
```

Slice exceptions are thrown as C++ exceptions, so you can simply enclose one or more operation invocations in a `try-catch` block:

```
ChildPrx child = ...;           // Get proxy...
try {
    child->askToCleanUp();       // Give it a try...
} catch (const Tantrum& t) {
    cout << "The child says: " << t.reason << endl;
}
```

Typically, you will catch only a few exceptions of specific interest around an operation invocation; other exceptions, such as unexpected run-time errors, will typically be dealt with by exception handlers higher in the hierarchy. For example:

```
void run()
{
    ChildPrx child = ...;       // Get proxy...
    try {
        child->askToCleanUp(); // Give it a try...
    } catch (const Tantrum& t) {
        cout << "The child says: " << t.reason << endl;

        child->scold();         // Recover from error...
    }
    child->praise();            // Give positive feedback...
}

int
main(int argc, char* argv[])
{
    int status = 1;
    try {
        // ...
        run();
        // ...
        status = 0;
    }
```

```
    } catch (const Ice::Exception& e) {  
        cerr << "Unexpected run-time error: " << e << endl;  
    }  
    // ...  
    return status;  
}
```

This code handles a specific exception of local interest at the point of call and deals with other exceptions generically. (This is also the strategy we used for our first simple application in Chapter 3.)

For efficiency reasons, you should always catch exceptions by `const` reference. This permits the compiler to avoid calling the exception's copy constructor (and, of course, prevents the exception from being sliced to a base type).

Exceptions and out-Parameters

The Ice run time makes no guarantees about the state of out-parameters when an operation throws an exception: the parameter may have still have its original value or may have been changed by the operation's implementation in the target object. In other words, for out-parameters, Ice provides the weak exception guarantee [21] but does not provide the strong exception guarantee.⁴

Exceptions and Return Values

For return values, C++ provides the guarantee that a variable receiving the return value of an operation will not be overwritten if an exception is thrown. (Of course, this guarantee holds only if you do not use the same variable as both an out-parameter and to receive the return value of an invocation (see page 213).)

6.14 Mapping for Classes

Slice classes are mapped to C++ classes with the same name. The generated class contains a public data member for each Slice data member, and a virtual member function for each operation. Consider the following class definition:

4. This is done for reasons of efficiency: providing the strong exception guarantee would require more overhead than can be justified.

```
class TimeOfDay {
    short hour;           // 0 - 23
    short minute;        // 0 - 59
    short second;        // 0 - 59
    string format();     // Return time as hh:mm:ss
};
```

The Slice compiler generates the following code for this definition:⁵

```
class TimeOfDay;

typedef IceInternal::ProxyHandle<IceProxy::TimeOfDay> TimeOfDayPrx
;
typedef IceInternal::Handle<TimeOfDay> TimeOfDayPtr;

class TimeOfDay : virtual public Ice::Object {
public:
    Ice::Short hour;
    Ice::Short minute;
    Ice::Short second;

    virtual std::string format() = 0;

    TimeOfDay() {};
    TimeOfDay(Ice::Short, Ice::Short, Ice::Short);

    virtual bool ice_isA(const std::string&);
    virtual const std::string& ice_id();
    static const std::string& ice_staticId();

    typedef TimeOfDayPrx ProxyType;
    typedef TimeOfDayPtr PointerType;

    // ...
};
```

There are a number of things to note about the generated code:

1. The generated class `TimeOfDay` inherits from `Ice::Object`. This means that all classes implicitly inherit from `Ice::Object`, which is the ultimate ancestor of all classes. Note that `Ice::Object` is *not* the same as `IceProxy::Ice::Object`. In other words, you *cannot* pass a class where

5. The `ProxyType` and `PointerType` definitions are for template programming (see page 201).

a proxy is expected and vice versa. (However, you *can* pass a proxy for the class—see Section 6.14.6.)

2. The generated class contains a public member for each Slice data member.
3. The generated class has a constructor that takes one argument for each data member, as well as a default constructor.
4. The generated class contains a pure virtual member function for each Slice operation.
5. The generated class contains additional member functions: `ice_isA`, `ice_id`, `ice_staticId`, and `ice_factory`.
6. The compiler generates a type definition `TimeOfDayPtr`. This type implements a smart pointer that wraps dynamically-allocated instances of the class. In general, the name of this type is `<class-name>Ptr`. Do not confuse this with `<class-name>Prx`—that type exists as well, but is the proxy handle for the class, not a smart pointer.

There is quite a bit to discuss here, so we will look at each item in turn.

6.14.1 Inheritance from `Ice::Object`

Like interfaces, classes implicitly inherit from a common base class, `Ice::Object`. However, as shown in Figure 6.1, classes inherit from `Ice::Object` instead of `Ice::ObjectPrx` (which is at the base of the inheritance hierarchy for proxies). As a result, you cannot pass a class where a proxy is expected (and vice versa) because the base types for classes and proxies are not compatible.

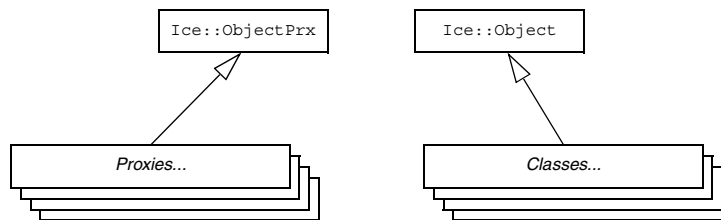

Figure 6.1. Inheritance from `Ice::ObjectPrx` and `Ice::Object`.

`Ice::Object` contains a number of member functions:

```

namespace Ice {
    class Object : public IceUtil::GCShared {
    public:
        virtual bool ice_isA(const std::string&,
                           const Current& = Current()) const;
        virtual void ice_ping(const Current& = Current()) const;
        virtual std::vector<std::string> ice_ids(
            const Current& = Current()) const;
        virtual const std::string& ice_id(
            const Current& = Current()) const;
        static const std::string& ice_staticId();
        virtual Ice::Int ice_getHash() const;
        virtual ObjectPtr ice_clone() const;

        virtual void ice_preMarshal();
        virtual void ice_postUnmarshal();

        virtual bool operator==(const Object&) const;
        virtual bool operator!=(const Object&) const;
        virtual bool operator<(const Object&) const;
        virtual bool operator<=(const Object&) const;
        virtual bool operator>(const Object&) const;
        virtual bool operator>=(const Object&) const;
    };
}

```

The member functions of `Ice::Object` behave as follows:

- `ice_isA`
This function returns `true` if the object supports the given type ID, and `false` otherwise.
- `ice_ping`
As for interfaces, `ice_ping` provides a basic reachability test for the class.
- `ice_ids`
This function returns a string sequence representing all of the type IDs supported by this object, including `Ice::Object`.
- `ice_id`
This function returns the actual run-time type ID for a class. If you call `ice_id` through a smart pointer to a base instance, the returned type id is the actual (possibly more derived) type ID of the instance.
- `ice_staticId`
This function returns the static type ID of a class.

- `ice_getHash`
This method returns a hash value for the class, allowing you to easily place classes into hash tables.
- `ice_clone`
This function makes a polymorphic shallow copy of a class (see page 230).
- `ice_preMarshal`
The Ice run time invokes this function prior to marshaling the object's state, providing the opportunity for a subclass to validate its declared data members.
- `ice_postUnmarshal`
The Ice run time invokes this function after unmarshaling an object's state. A subclass typically overrides this function when it needs to perform additional initialization using the values of its declared data members.
- `operator==`
`operator!=`
`operator<`
`operator<=`
`operator>`
`operator>=`
The comparison operators permit you to use classes as elements of STL sorted containers. Note that sort order is based on the data members of the class, as for structures (see Section 6.12).

6.14.2 Data Members of Classes

Data members of classes are mapped exactly as for structures and exceptions: for each data member in the Slice definition, the generated class contains a corresponding public data member.

6.14.3 Class Constructors

Classes have a default constructor. This constructor default-constructs each data member. This means that, for members of simple built-in type, such as integers, the default constructor performs no initialization, whereas members of complex type, such as strings, sequences, and dictionaries, are initialized by their own default constructor.

In addition, classes have a second constructor that has one parameter for each data member. This allows you to construct and initialize a class instance in a single statement (instead of first having to construct the instance and then assigning to its members).

For derived classes, the constructor has one parameter for each of the base class's data members, plus one parameter for each of the derived class's data members, in base-to-derived order. For example:

```
class Base {
    int i;
};

class Derived extends Base {
    string s;
};
```

This generates:

```
class Base : virtual public ::Ice::Object
{
public:
    ::Ice::Int i;

    Base() {};
    explicit Base(::Ice::Int);

    // ...
};

class Derived : virtual public Base
{
public:
    ::std::string s;

    Derived() {};
    Derived(::Ice::Int, const ::std::string&);

    // ...
};
```

Note that single-parameter constructors are defined as `explicit`, to prevent implicit argument conversions.

6.14.4 Operations of Classes

Operations of classes are mapped to pure virtual member functions in the generated class. This means that, if a class contains operations (such as the format operation of our `TimeOfDay` class), you must provide an implementation of the operation in a class that is derived from the generated class. For example:⁶

```
class TimeOfDayI : virtual public TimeOfDay {
public:
    virtual std::string format() {
        std::ostringstream s;
        s << setw(2) << setfill('0') << hour << ":";
        s << setw(2) << setfill('0') << minute << ":";
        s << setw(2) << setfill('0') << second;
        return s.c_str();
    }

protected:
    virtual ~TimeOfDayI {} // Optional
};
```

6.14.5 Class Factories

Having created a class such as `TimeOfDayI`, we have an implementation and we can instantiate the `TimeOfDayI` class, but we cannot receive it as the return value or as an out-parameter from an operation invocation. To see why, consider the following simple interface:

```
interface Time {
    TimeOfDay get();
};
```

When a client invokes the `get` operation, the Ice run time must instantiate and return an instance of the `TimeOfDay` class. However, `TimeOfDay` is an abstract class that cannot be instantiated. Unless we tell it, the Ice run time cannot magically know that we have created a `TimeOfDayI` class that implements the abstract `format` operation of the `TimeOfDay` abstract class. In other words, we must provide the Ice run time with a factory that knows that the `TimeOfDay` abstract class has a `TimeOfDayI` concrete implementation. The `Ice::Communicator` interface provides us with the necessary operations:

6. We discuss the motivation for the protected destructor on page 232.

```

module Ice {
    local interface ObjectFactory {
        Object create(string type);
        void destroy();
    };

    local interface Communicator {
        void addObjectFactory(ObjectFactory factory, string id);
        ObjectFactory findObjectFactory(string id);
        // ...
    };
};

```

To supply the Ice run time with a factory for our `TimeOfDayI` class, we must implement the `ObjectFactory` interface:

```

module Ice {
    local interface ObjectFactory {
        Object create(string type);
        void destroy();
    };
};

```

The object factory's `create` operation is called by the Ice run time when it needs to instantiate a `TimeOfDay` class. The factory's `destroy` operation is called by the Ice run time when its communicator is destroyed. A possible implementation of our object factory is:

```

class ObjectFactory : public Ice::ObjectFactory {
public:
    virtual Ice::ObjectPtr create(const std::string& type) {
        assert(type == "::M::TimeOfDay");
        return new TimeOfDayI;
    }
    virtual void destroy() {}
};

```

The `create` method is passed the type ID (see Section 4.13) of the class to instantiate. For our `TimeOfDay` class, the type ID is `"::M::TimeOfDay"`. Our implementation of `create` checks the type ID: if it is `"::M::TimeOfDay"`, it instantiates and returns a `TimeOfDayI` object. For other type IDs, it asserts because it does not know how to instantiate other types of objects.

Given a factory implementation, such as our `ObjectFactory`, we must inform the Ice run time of the existence of the factory:

```
Ice::CommunicatorPtr ic = ...;  
ic->addObjectFactory(new ObjectFactory, "::M::TimeOfDay");
```

Now, whenever the Ice run time needs to instantiate a class with the type ID `::M::TimeOfDay`, it calls the `create` method of the registered `ObjectFactory` instance.

The `destroy` operation of the object factory is invoked by the Ice run time when the communicator is destroyed. This gives you a chance to clean up any resources that may be used by your factory. Do not call `destroy` on the factory while it is registered with the communicator—if you do, the Ice run time has no idea that this has happened and, depending on what your `destroy` implementation is doing, may cause undefined behavior when the Ice run time tries to next use the factory.

The run time guarantees that `destroy` will be the last call made on the factory, that is, `create` will not be called concurrently with `destroy`, and `create` will not be called once `destroy` has been called. However, calls to `create` can be made concurrently.

Note that you cannot register a factory for the same type ID twice: if you call `addObjectFactory` with a type ID for which a factory is registered, the Ice run time throws an `AlreadyRegisteredException`.

Finally, keep in mind that if a class has only data members, but no operations, you need not create and register an object factory to transmit instances of such a class. Only if a class has operations do you have to define and register an object factory.

6.14.6 Smart Pointers for Classes

A recurring theme for C++ programmers is the need to deal with memory allocations and deallocations in their programs. The difficulty of doing so is well known: in the face of exceptions, multiple return paths from functions, and callee-allocated memory that must be deallocated by the caller, it can be extremely difficult to ensure that a program does not leak resources. This is particularly important in multi-threaded programs: if you do not rigorously track ownership of dynamic memory, a thread may delete memory that is still used by another thread, usually with disastrous consequences.

To alleviate this problem, Ice provides smart pointers for classes. These smart pointers use reference counting to keep track of each class instance and, when the last reference to a class instance disappears, automatically delete the instance.⁷ Smart pointers are generated by the Slice compiler for each class type. For a Slice

class `<class-name>`, the compiler generates a C++ smart pointer called `<class-name>Ptr`. Rather than showing all the details of the generated class, here is the basic usage pattern: whenever you allocate a class instance on the heap, you simply assign the pointer returned from `new` to a smart pointer for the class. Thereafter, memory management is automatic and the class instance is deleted once the last smart pointer for it goes out of scope:

```
{
    TimeOfDayPtr tod = new TimeOfDayI; // Allocate instance
    // Initialize...
    tod->hour = 18;
    tod->minute = 11;
    tod->second = 15;
    // ...
} // No memory leak here!
```

As you can see, you use `operator->` to access the members of the class via its smart pointer. When the `tod` smart pointer goes out of scope, its destructor runs and, in turn, the destructor takes care of calling `delete` on the underlying class instance, so no memory is leaked.

The smart pointers perform reference counting of their underlying class instance:

- The constructor of a class sets its reference count to zero.
- Initializing a smart pointer with a dynamically-allocated class instance causes the smart pointer to increment the reference count for the class by one.
- Copy constructing a smart pointer increments the reference count for the class by one.
- Assigning one smart pointer to another increments the target's reference count and decrements the source's reference count. (Self-assignment is safe.)
- The destructor of a smart pointer decrements the reference count by one and calls `delete` on its class instance if the reference count drops to zero.

Figure 6.2 shows the situation after default-constructing a smart pointer as follows:

```
TimeOfDayPtr tod;
```

7. Smart pointer classes are an example of the *RAII* (*Resource Acquisition Is Initialization*) idiom [20].

This creates a smart pointer with an internal null pointer.

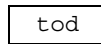

Figure 6.2. Newly initialized smart pointer.

Constructing a class instance creates that instance with a reference count of zero; the assignment to the class pointer causes the smart pointer to increment the class's reference count:

```
tod = new TimeOfDayI; // Refcount == 1
```

The resulting situation is shown in Figure 6.3.

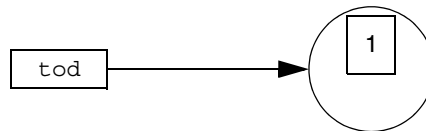

Figure 6.3. Initialized smart pointer.

Assigning or copy-constructing a smart pointer assigns and copy-constructs the smart pointer (not the underlying instance) and increments the reference count of the instance:

```
TimeOfDayPtr tod2(tod); // Copy-construct tod2
TimeOfDayPtr tod3;
tod3 = tod;             // Assign to tod3
```

The situation after executing these statements is shown in Figure 6.4:

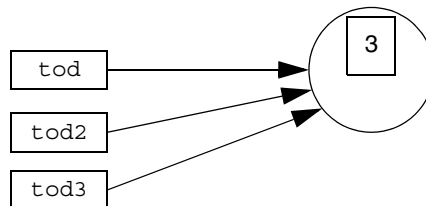

Figure 6.4. Three smart pointers pointing at the same class instance.

Continuing the example, we can construct a second class instance and assign it to one of the original smart pointers, `tod2`:

```
tod2 = new TimeOfDayI;
```

This decrements the reference count of the class originally denoted by `tod2` and increments the reference count of the class that is assigned to `tod2`. The resulting situation is shown in Figure 6.5.

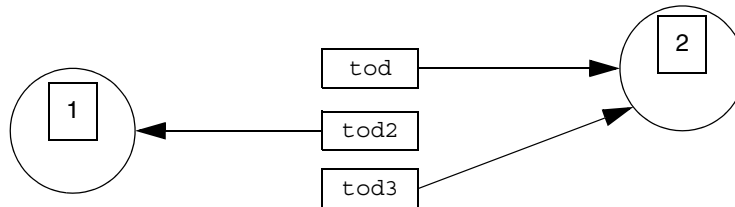

Figure 6.5. Three smart pointers and two instances.

You can clear a smart pointer by assigning zero to it:

```
tod = 0;          // Clear handle
```

As you would expect, this decrements the reference count of the instance, as shown in Figure 6.6.

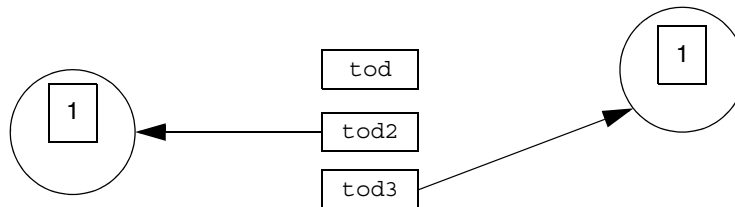

Figure 6.6. Decremented reference count after clearing a smart pointer.

If a smart pointer goes out of scope, is cleared, or has a new instance assigned to it, the smart pointer decrements the reference count of its instance; if the reference count drops to zero, the smart pointer calls `delete` to deallocate the instance. The following code snippet deallocates the instance on the right by assigning `tod2` to `tod3`:

```
tod3 = tod2;
```

This results in the situation shown in Figure 6.7.

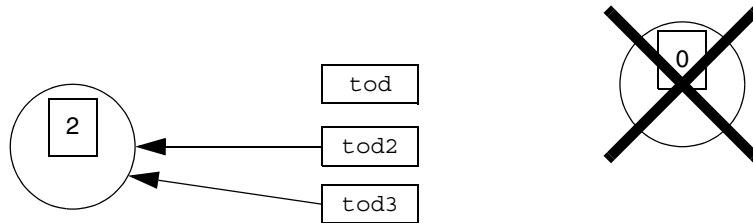

Figure 6.7. Deallocation of an instance with a reference count of zero.

Copying and Assignment of Classes

Classes have a default memberwise copy constructor and assignment operator, so you can copy and assign class instances:

```
TimeOfDayPtr tod = new TimeOfDayI(2, 3, 4); // Create instance
TimeOfDayPtr tod2 = new TimeOfDayI(*tod); // Copy instance

TimeOfDayPtr tod3 = new TimeOfDayI;
*tod3 = *tod; // Assign instance
```

Copying and assignment in this manner performs a memberwise shallow copy or assignment, that is, the source members are copied into the target members; if a class contains class members (which are mapped as smart pointers), what is copied or assigned is the smart pointer, not the target of the smart pointer.

To illustrate this, consider the following Slice definitions:

```
class Node {
    int i;
    Node next;
};
```

Assume that we initialize two instances of type Node as follows:

```
NodePtr p1 = new Node(99, new Node(48, 0));
NodePtr p2 = new Node(23, 0);

// ...

*p2 = *p1; // Assignment
```

After executing the first two statements, we have the situation shown in Figure 6.8.

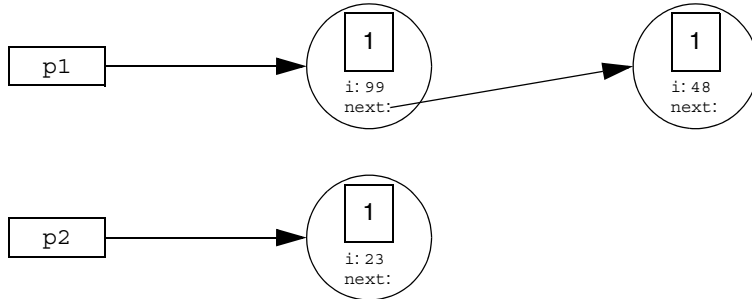

Figure 6.8. Class instances prior to assignment.

After executing the assignment statement, we end up with the result shown in Figure 6.9.

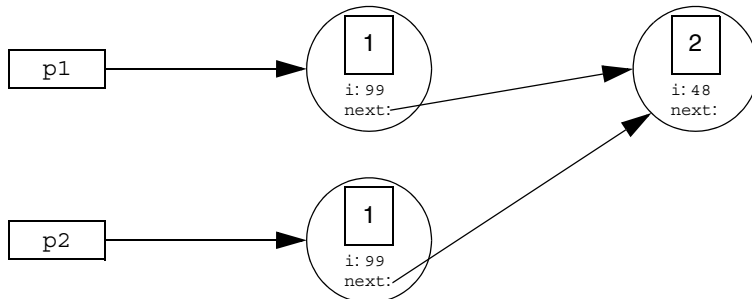

Figure 6.9. Class instances after assignment.

Note that copying and assignment also works for the implementation of abstract classes, such as our `TimeOfDayI` class, for example:

```

class TimeOfDayI;

typedef IceUtil::Handle<TimeOfDayI> TimeOfDayIPtr;

class TimeOfDayI : virtual public TimeOfDay {
    // As before...
};
  
```

The default copy constructor and assignment operator will perform a memberwise copy or assignment of your implementation class:

```
TimeOfDayIPtr tod1 = new TimeOfDayI;
TimeOfDayIPtr tod2 = new TimeOfDayI(*tod1);    // Make copy
```

Of course, if your implementation class contains raw pointers (for which a memberwise copy would almost certainly be inappropriate), you must implement your own copy constructor and assignment operator that take the appropriate action (and probably call the base copy constructor or assignment operator to take care of the base part).

Note that the preceding code uses `TimeOfDayIPtr` as a typedef for `IceUtil::Handle<TimeOfDayI>`. This class is a template that contains the smart pointer implementation. If you want smart pointers for the implementation of an abstract class, you must define a smart pointer type as illustrated by this type definition.

Copying and assignment of classes also works correctly for derived classes: you can assign a derived class to a base class, but not vice-versa; during such an assignment, the derived part of the source class is sliced, as per the usual C++ assignment semantics.

Polymorphic Copying of Classes

As shown in Section 6.14.1 on page 218, the C++ mapping generates an `ice_clone` member function for every class:

```
class TimeOfDay : virtual public Ice::Object {
public:
    // ...

    virtual Ice::ObjectPtr ice_clone() const;
};
```

This member function makes a polymorphic shallow copy of a class: members that are not class members are deep copied; all members that are class members are shallow copied. To illustrate, consider the following class definition:

```
class Node {
    Node n1;
    Node n2;
};
```

Assume that we have an instance of this class, with the `n1` and `n2` members initialized to point at separate instances, as shown in Figure 6.10.

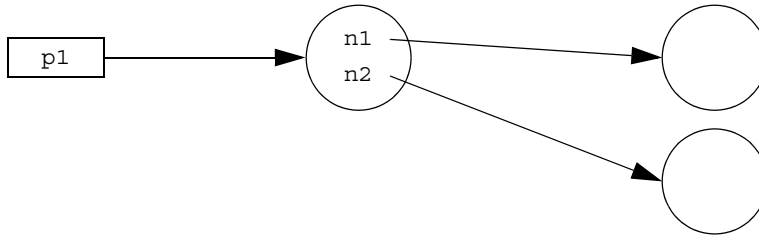

Figure 6.10. A class instance pointing to two other instances.

If we call `ice_clone` on the instance on the left, we end up with the situation shown in Figure 6.11.

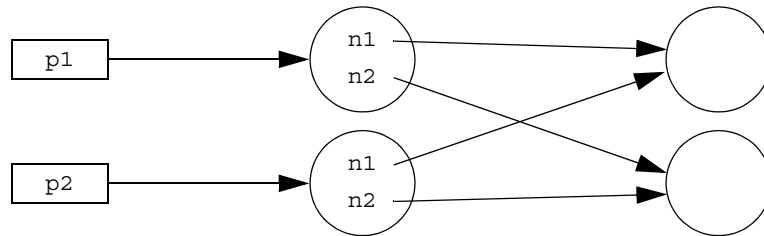

Figure 6.11. Resulting graph after calling `ice_clone` on the left-most instance of Figure 6.10.

As you can see, class members are shallow copied, that is, `ice_clone` makes a copy of the class instance on which it is invoked, but does not copy any class instances that are pointed at by the copied instance.

Note that `ice_clone` returns a value of type `Ice::ObjectPtr`, to avoid problems with compilers that do not support covariant return types. The generated `Ptr` classes contain a `dynamicCast` member that allows you to safely down-cast the return value of `ice_clone`. For example, the code to achieve the situation shown in Figure 6.11 looks as follows:

```
NodePtr p1 = new Node(new Node, new Node);
NodePtr p2 = NodePtr::dynamicCast(p1->ice_clone());
```

`ice_clone` is generated by the Slice compiler for concrete classes (that is, classes that do not have operations). However, because classes with operations are abstract, for abstract classes, the generated `ice_clone` cannot know how to

instantiate an instance of the derived concrete class (because the name of the derived class is not known). This means that, for abstract classes, the generated `ice_clone` throws a `CloneNotImplementedException`.

If you want to clone the implementation of an abstract class, you must override the virtual `ice_clone` member in your concrete implementation class. For example:

```
class TimeOfDayI : public TimeOfDay {
public:
    virtual Ice::ObjectPtr ice_clone() const
    {
        return new TimeOfDayI(*this);
    }
};
```

Null Smart Pointers

A null smart pointer contains a null C++ pointer to its underlying instance. This means that if you attempt to dereference a null smart pointer, you get an `IceUtil::NullHandleException`:

```
TimeOfDayPtr tod;                // Construct null handle

try {
    tod->minute = 0;              // Dereference null handle
    assert(false);              // Cannot get here
} catch (const IceUtil::NullHandleException&) {
    ; // OK, expected
} catch (...) {
    assert(false);              // Must get NullHandleException
}
```

Preventing Stack-Allocation of Class Instances

The Ice C++ mapping expects class instances to be allocated on the heap. Allocating class instances on the stack or in static variables is pragmatically useless because all the Ice APIs expect parameters that are smart pointers, not class instances. This means that, to do anything with a stack-allocated class instance, you must initialize a smart pointer for the instance. However, doing so does not work because it inevitably leads to a crash:

```

{
    TimeOfDayI t;           // Stack-allocated class instance
    TimeOfDayPtr todp;     // Handle for a TimeOfDay instance

    todp = &t;             // Legal, but dangerous
    // ...
}                          // Leave scope, looming crash!

```

This goes badly wrong because, when `todp` goes out of scope, it decrements the reference count of the class to zero, which then calls `delete` on itself. However, the instance is stack-allocated and cannot be deleted, and we end up with undefined behavior (typically, a core dump).

The following attempt to fix this is also doomed to failure:

```

{
    TimeOfDayI t;           // Stack-allocated class instance
    TimeOfDayPtr todp;     // Handle for a TimeOfDay instance

    todp = &t;             // Legal, but dangerous
    // ...
    todp = 0;              // Crash imminent!
}

```

This code attempts to circumvent the problem by clearing the smart pointer explicitly. However, doing so also causes the smart pointer to drop the reference count on the class to zero, so this code ends up with the same call to `delete` on the stack-allocated instance as the previous example.

The upshot of all this is: *never* allocate a class instance on the stack or in a static variable. The C++ mapping assumes that all class instances are allocated on the heap and no amount of coding trickery will change this.⁸

You can prevent allocation of class instances on the stack or in static variables by adding a protected destructor to your implementation of the class: if a class has a protected destructor, allocation must be made with `new`, and static or stack allocation causes a compile time error. In addition, explicit calls to `delete` on a heap-allocated instance also are flagged at compile time. You may want to habitually add a protected destructor to your implementation of abstract `Slice` classes to protect yourself from accidental heap allocation, as shown on page 222. (For `Slice`

8. You could abuse the `__setNoDelete` member (described on page 236) to disable deallocation, but we strongly discourage you from doing this.

classes that do not have operation, the Slice compiler automatically adds a protected destructor.)

Smart Pointers and Exception Safety

Smart pointers are exception safe: if an exception causes the thread of execution to leave a scope containing a stack-allocated smart pointer, the C++ run time ensures that the smart pointer's destructor is called, so no resource leaks can occur:

```
{ // Enter scope...

    TimeOfDayPtr tod = new TimeOfDayI; // Allocate instance

    someFuncThatMightThrow();          // Might throw...

    // ...

} // No leak here, even if an exception is thrown
```

If an exception is thrown, the destructor of `tod` runs and ensures that it deallocates the underlying class instance.

There is one potential pitfall you must be aware of though: if a constructor of a base class throws an exception, and another class instance holds a smart pointer to the instance being constructed, you can end up with a double deallocation. Consider the following example, which reduces the problem to its bare-bones minimum:

```
class Base;
typedef IceUtil::Handle<Base> BasePtr;

class Listener : public virtual IceUtil::Shared {
public:
    Listener(BasePtr p) {
        _parent = p;
    }

    virtual ~Listener() {
        _parent = 0;
    }

private:
    BasePtr _parent;
};

typedef IceUtil::Handle<Listener> ListenerPtr;
```



```
class Base : public virtual IceUtil::Shared {
public:
    Base() {
        _listener = new Listener(this);
    }

    virtual ~Base() {
        _listener = 0;
    }

private:
    ListenerPtr _listener;
};

class Derived : public virtual Base {
public:
    Derived() {
        if (errorCondition)
            throw "Some error";
    }
};

typedef IceUtil::Handle<Derived> DerivedPtr;

int main()
{
    try {
        DerivedPtr d = new Derived;
    } catch (...) {
        // ...
    }
    return 0;
}
```

This type of code is used, for example, for the listener pattern [2]. Consider what happens when the statement

```
DerivedPtr d = new Derived;
```

is executed in main and `errorCondition` is true:

1. The Base constructor is called (because Base is a base class of Derived).
2. The constructor of Base allocates an instance of Listener, which results in a call to the Listener constructor.

3. The `Listener` constructor assigns its argument to the `_parent` member, which leaves the reference count of the `Derived` object being instantiated at one.
4. The `Listener` constructor completes and returns control to the `Base` constructor, which assigns the newly-constructed `Listener` object to its `_listener` member, of type `ListenerPtr`. At this point, the reference count of the `Listener` object changes from zero to one.
5. The `Base` constructor completes, so the C++ run time continues to construct the `Derived` object being instantiated by calling the `Derived` constructor.
6. The `Derived` constructor throws an exception. As a result, the C++ run time calls the `Base` destructor.
7. The `Base` destructor assigns null to its `_listener` member, which drops the reference count of its `Listener` object to zero. As a result, the `Listener` object calls `delete this;`
8. The `Listener` destructor runs and assigns null to its `_listener` member. The `_listener` smart pointer drops the reference count of its `Base` object to zero. As a result, the `Base` object calls `delete this;`
9. The C++ run time calls the `Base` destructor.

At this point, the program shows undefined behavior (usually, dumps core) because the `Base` destructor is called a second time on the same object.

We can solve the problem by telling the `Derived` instance that it should *not* deallocate itself while the `Derived` constructor may still throw an exception. The `IceUtil::Shared` class provides a `__setNoDelete` member function that allows us to do this:

```
class Derived : public virtual Base {
public:
    Derived() {
        __setNoDelete(true);
        if (errorCondition)
            throw "Some error";
        __setNoDelete(false);
    }
};
```

Here, we have changed the `Derived` constructor to disable deallocation of its object until we know that no more exceptions can be thrown. Once the constructor is certain to complete successfully, it enables deallocation again, so the object will be deallocated once its reference count drops to zero.

Smart Pointers and Cycles

One thing you need to be aware of is the inability of reference counting to deal with cyclic dependencies. For example, consider the following simple self-referential class:

```
class Node {
    int val;
    Node next;
};
```

Intuitively, this class implements a linked list of nodes. As long as there are no cycles in the list of nodes, everything is fine, and our smart pointers will correctly deallocate the class instances. However, if we introduce a cycle, we have a problem:

```
{                                     // Open scope...

    NodePtr n1 = new Node; // N1 refcount == 1
    NodePtr n2 = new Node; // N2 refcount == 1
    n1->next = n2;         // N2 refcount == 2
    n2->next = n1;         // N1 refcount == 2

} // Destructors run:                // N2 refcount == 1,
                                     // N1 refcount == 1, memory leak!
```

The nodes pointed to by `n1` and `n2` do not have names but, for the sake of illustration, let us assume that `n1`'s node is called `N1`, and `n2`'s node is called `N2`. When we allocate the `N1` instance and assign it to `n1`, the smart pointer `n1` increments `N1`'s reference count to 1. Similarly, `N2`'s reference count is 1 after allocating the node and assigning it to `n2`. The next two statements set up a cyclic dependency between `n1` and `n2` by making their `next` pointers point at each other. This sets the reference count of both `N1` and `N2` to 2. When the enclosing scope closes, the destructor of `n2` is called first and decrements `N2`'s reference count to 1, followed by the destructor of `n1`, which decrements `N1`'s reference count to 1. The net effect is that neither reference count ever drops to zero, so both `N1` and `N2` are leaked.

Garbage Collection of Class Instances

The previous example illustrates a problem that is generic to using reference counts for deallocation: if a cyclic dependency exists anywhere in a graph (possibly via many intermediate nodes), all nodes in the cycle are leaked.

To avoid memory leaks due to such cycles, Ice for C++ contains a garbage collector. The collector identifies class instances that are part of one or more cycles but are no longer reachable from the program and deletes such instances:

- By default, garbage is collected whenever you destroy a communicator. This means that no memory is leaked when your program exits. (Of course, this assumes that you correctly destroy your communicators as described in Section 8.3.)
- You can also explicitly call the garbage collector by calling `Ice::collectGarbage`. For example, the leak caused by the preceding example can be avoided as follows:

```
{                                     // Open scope...

    NodePtr n1 = new Node; // N1 refcount == 1
    NodePtr n2 = new Node; // N2 refcount == 1
    n1->next = n2;         // N1 refcount == 2
    n2->next = n1;         // N2 refcount == 2

} // Destructors run:                // N2 refcount == 1,
                                     // N1 refcount == 1

Ice::collectGarbage();               // Deletes N1 and N2
```

The call to `Ice::collectGarbage` deletes the no longer reachable instances N1 and N2 (as well as any other non-reachable instances that may have accumulated earlier).

- Deleting leaked memory with explicit calls to the garbage collector can be inconvenient because it requires polluting the code with calls to the collector. You can ask the Ice run time to run a garbage collection thread that periodically cleans up leaked memory by setting the property `Ice.GC.Interval` to a non-zero value.⁹ For example, setting `Ice.GC.Interval` to 5 causes the collector thread to run the garbage collector once every five seconds. You can trace the execution of the collector by setting `Ice.Trace.GC` to a non-zero value (Appendix C).

Note that the garbage collector is useful *only* if your program actually creates cyclic class graphs. There is no point in running the garbage collector in programs that do not create such cycles. (For this reason, the collector thread is disabled by

9. See Chapter 30 for how to set properties.

default and runs only if you explicitly set `Ice.GC.Interval` to a non-zero value.)

Smart Pointer Comparison

As for proxy handles (see Section 6.11.3 on page 206), class handles support the comparison operators `==`, `!=`, and `<`. This allows you to use class handles in STL sorted containers. Be aware that, for smart pointers, object identity is *not* used for the comparison, because class instances do not have identity. Instead, these operators simply compare the memory address of the classes they point to. This means that `operator==` returns true only if two smart pointers point at the same physical class instance:

```
// Create a class instance and initialize
//
TimeOfDayIPtr p1 = new TimeOfDayI;
p1->hour = 23;
p1->minute = 10;
p1->second = 18;

// Create another class instance with
// the same member values
//
TimeOfDayIPtr p2 = new TimeOfDayI;
p2->hour = 23;
p2->minute = 10;
p2->second = 18;

assert(p1 != p2);          // The two do not compare equal

TimeOfDayIPtr p3 = p1;    // Point at first class again

assert(p1 == p3);        // Now they compare equal
```

6.15 `slice2cpp` Command-Line Options

The Slice-to-C++ compiler, `slice2cpp`, offers the following command-line options in addition to the standard options described in Section 4.19:

- `--header-ext EXT`

Changes the file extension for the generated header files from the default `h` to the extension specified by `EXT`.

- **--source-ext** *EXT*

Changes the file extension for the generated source files from the default `cpp` to the extension specified by *EXT*.

- **--add-header** *HDR[, GUARD]*

This option adds an include directive for the specified header at the beginning of the generated source file (preceding any other include directives). If *GUARD* is specified, the include directive is protected by the specified guard. For example, **--add-header** `precompiled.h, __PRECOMPILED_H__` results in the following directives at the beginning of the generated source file:

```
#ifndef __PRECOMPILED_H__
#define __PRECOMPILED_H__
#include <precompiled.h>
#endif
```

The option can be repeated to create include directives for several files.

As suggested by the preceding example, this option is useful mainly to integrate the generated code with a compiler's precompiled header mechanism.

- **--include-dir** *DIR*

Modifies `#include` directives in source files to prepend the pathname of each header file with the directory *DIR*. See Section 6.15.1 for more information.

- **--impl**

Generate sample implementation files. This option will not overwrite an existing file.

- **--depend**

Prints makefile dependency information to standard output. No code is generated when this option is specified. The output generally needs to be filtered before it can be included in a makefile; the Ice build system uses the script `config/makedepend.py` for this purpose.

- **--dll-export** *SYMBOL*

Use *SYMBOL* to control DLL exports or imports. This option allows you to selectively export or import global symbols in the generated code. As an example, compiling a Slice definition with

```
$ slice2cpp --dll-export ENABLE_DLL x.ice
```

results in the following additional code being generated into `x.h`:

```
#ifndef ENABLE_DLL
```

```
#   ifdef ENABLE_DLL_EXPORTS
#       define ENABLE_DLL ICE_DECLSPEC_EXPORT
#   else
#       define ENABLE_DLL ICE_DECLSPEC_IMPORT
#   endif
#endif
```

ICE_DECLSPEC_EXPORT and ICE_DECLSPEC_IMPORT are platform-specific macros. For example, for Windows, they are defined as `__declspec(dllexport)` and `__declspec(dllimport)`, respectively; for Solaris using **CC** version 5.5 or later, ICE_DECLSPEC_EXPORT is defined as `__global`, and ICE_DECLSPEC_IMPORT is empty.¹⁰

The symbol name you specify on the command line (ENABLE_DLL in this example) is used by the generated code to export or import any symbols that must be visible to code outside the generated compilation unit. The net effect is that, if you want to create a DLL that includes `x.cpp`, but also want to use the generated types in compilation units outside the DLL, you can arrange for the relevant symbols to be exported by compiling `x.cpp` with **-DENABLE_DLL_EXPORTS**.

- **--checksum**
Generate checksums for Slice definitions.
- **--stream**
Generate streaming helper functions for Slice types (see Section 36.2).

6.15.1 Include Directives

The `#include` directives generated by the Slice-to-C++ compiler can be a source of confusion if the semantics governing their generation are not well-understood. The generation of `#include` directives is influenced by the command-line options **-I** and **--include-dir**; these options are discussed in more detail below. The **--output-dir** option directs the translator to place all generated files in a particular directory, but has no impact on the contents of the generated code.

Given that the `#include` directives in header files and source files are generated using different semantics, we describe them in separate sections.

¹⁰Similar definitions exist for other platforms. For platforms that do not have any concept of explicit export or import of shared library symbols, both macros are empty.

Header Files

In most cases, the compiler generates the appropriate `#include` directives by default. As an example, suppose file `A.ice` includes `B.ice` using the following statement:

```
// A.ice
#include <B.ice>
```

Assuming both files are in the current working directory, we run the compiler as shown below:

```
$ slice2cpp -I. A.ice
```

The generated file `A.h` contains this `#include` directive:

```
// A.h
#include <B.h>
```

If the proper include paths are specified to the C++ compiler, everything should compile correctly.

Similarly, consider the common case where `A.ice` includes `B.ice` from a subdirectory:

```
// A.ice
#include <inc/B.ice>
```

Assuming both files are in the `inc` subdirectory, we run the compiler as shown below:

```
$ slice2cpp -I. inc/A.ice
```

The default output of the compiler produces this `#include` directive in `A.h`:

```
// A.h
#include <inc/B.h>
```

Again, it is the user's responsibility to ensure that the C++ compiler is configured to find `inc/B.h` during compilation.

Now let us consider a more complex example, in which we do not want the `#include` directive in the header file to match that of the Slice file. This can be necessary when the organizational structure of the Slice files does not match the application's C++ code. In such a case, the user may need to relocate the generated files from the directory in which they were created, and the `#include` directives must be aligned with the new structure.

For example, let us assume that `B.ice` is located in the subdirectory `slice/inc`:

```
// A.ice
#include <slice/inc/B.ice>
```

However, we do not want the `slice` subdirectory to appear in the `#include` directive generated in the header file, therefore we specify the additional compiler option `-Islice`:

```
$ slice2cpp -I. -Islice slice/inc/A.ice
```

The generated code demonstrates the impact of this extra option:

```
// A.h
#include <inc/B.h>
```

As you can see, the `#include` directives generated in header files are affected by the include paths that you specify when running the compiler. Specifically, the include paths are used to abbreviate the pathname in generated `#include` directives.

When translating an `#include` directive from a Slice file to a header file, the compiler compares each of the include paths against the path of the included file. If an include path matches the leading portion of the included file, the compiler removes that leading portion when generating the `#include` directive in the header file. If more than one include path matches, the compiler selects the one that results in the shortest path for the included file.

For example, suppose we had used the following options when compiling `A.ice`:

```
$ slice2cpp -I. -Islice -Islice/inc slice/inc/A.ice
```

In this case, the compiler compares all of the include paths against the included file `slice/inc/B.ice` and generates the following directive:

```
// A.h
#include <B.h>
```

The option `-Islice/inc` produces the shortest result, therefore the default path for the included file (`slice/inc/B.h`) is replaced with `B.h`.

In general, the `-I` option plays two roles: it enables the preprocessor to locate included Slice files, and it provides you with a certain amount of control over the generated `#include` directives. In the last example above, the preprocessor locates `slice/inc/B.ice` using the include path specified by the `-I.` option. The remaining `-I` options do not help the preprocessor locate included files; they are simply hints to the compiler.

Finally, we recommend using caution when specifying include paths. If the preprocessor is able to locate an included file via multiple include paths, it always

uses the first include path that successfully locates the file. If you intend to modify the generated `#include` directives by specifying extra `-I` options, you must ensure that your include path hints match the include path selected by the preprocessor to locate the included file. As a general rule, you should avoid specifying include paths that enable the preprocessor to locate a file in multiple ways.

Source Files

By default, the compiler generates `#include` directives in source files using only the base name of the included file. This behavior is usually appropriate when the source file and header file reside in the same directory.

For example, suppose `A.ice` includes `B.ice` from a subdirectory, as shown in the following snippet of `A.ice`:

```
// A.ice
#include <inc/B.ice>
```

We generate the source file using this command:

```
$ slice2cpp -I. inc/A.ice
```

Upon examination, we see that the source file contains the following `#include` directive:

```
// A.cpp
#include <B.h>
```

However, suppose that we wish to enforce a particular standard for generated `#include` directives so that they are compatible with our C++ compiler's existing include path settings. In this case, we use the `--include-dir` option to modify the generated code. For example, consider the compiler command shown below:

```
$ slice2cpp --include-dir src -I. inc/A.ice
```

The source file now contains the following `#include` directive:

```
// A.cpp
#include <src/B.h>
```

Any leading path in the included file is discarded as usual, and the value of the `--include-dir` option is prepended.

6.16 Using Slice Checksums

As described in Section 4.20, the Slice compilers can optionally generate checksums of Slice definitions. For `slice2cpp`, the `--checksum` option causes the compiler to generate code in each C++ source file that accumulates checksums in a global map. A copy of this map can be obtained by calling a function defined in the header file `Ice/SliceChecksums.h`:

```
namespace Ice {
    Ice::SliceChecksumDict sliceChecksums();
}
```

In order to verify a server's checksums, a client could simply compare the dictionaries using the equality operator. However, this is not feasible if it is possible that the server might be linked with more Slice definitions than the client. A more general solution is to iterate over the local checksums as demonstrated below:

```
Ice::SliceChecksumDict serverChecksums = ...
Ice::SliceChecksumDict localChecksums = Ice::sliceChecksums();

for (Ice::SliceChecksumDict::const_iterator
     p = localChecksums.begin();
     p != localChecksums.end(); ++p) {

    Ice::SliceChecksumDict::const_iterator q
        = serverChecksums.find(p->first);
    if(q == serverChecksums.end()) {
        // No match found for type id!
    } else if(p->second != q->second) {
        // Checksum mismatch!
    }
}
```

In this example, the client first verifies that the server's dictionary contains an entry for each Slice type ID, and then it proceeds to compare the checksums.

6.17 A Comparison with the CORBA C++ Mapping

Comparing the Slice and the CORBA C++ mappings is somewhat difficult because they are so different. As any CORBA C++ developer will know, the CORBA C++ mapping is large and complex and, in places, arcane. For example, the developer is burdened with a large number of error-prone memory manage-

ment responsibilities, and the rules for what must be deallocated by the developer and what is deallocated by the ORB are inconsistent.

Overall, the Ice C++ mapping is much easier to use, integrates with STL and, due to the smaller amount of generated code, is much more efficient.

Chapter 7

Developing a File System Client in C++

7.1 Chapter Overview

In this chapter, we present the source code for a C++ client that accesses the file system we developed in Chapter 5 (see Chapter 9 for the corresponding server).

7.2 The C++ Client

We now have seen enough of the client-side C++ mapping to develop a complete client to access our remote file system. For reference, here is the Slice definition once more:

```
module Filesystem {
    interface Node {
        nonmutating string name();
    };

    exception GenericError {
        string reason;
    };

    sequence<string> Lines;

    interface File extends Node {
```

```

        nonmutating Lines read();
        idempotent void write(Lines text) throws GenericError;
};

sequence<Node*> NodeSeq;

interface Directory extends Node {
    nonmutating NodeSeq list();
};

interface Filesys {
    nonmutating Directory* getRoot();
};
};

```

To exercise the file system, the client does a recursive listing of the file system, starting at the root directory. For each node in the file system, the client shows the name of the node and whether that node is a file or directory. If the node is a file, the client retrieves the contents of the file and prints them.

The body of the client code looks as follows:

```

#include <Ice/Ice.h>
#include <Filesystem.h>
#include <iostream>
#include <iterator>

using namespace std;
using namespace Filesystem;

static void
listRecursive(const DirectoryPrx& dir, int depth = 0)
{
    // ...
}

int
main(int argc, char* argv[])
{
    int status = 0;
    Ice::CommunicatorPtr ic;
    try {
        // Create a communicator
        //
        ic = Ice::initialize(argc, argv);
    }
}

```

```

        // Create a proxy for the root directory
        //
        Ice::ObjectPrx base
            = ic->stringToProxy("RootDir:default -p 10000");
        if (!base)
            throw "Could not create proxy";

        // Down-cast the proxy to a Directory proxy
        //
        DirectoryPrx rootDir = DirectoryPrx::checkedCast(base);
        if (!rootDir)
            throw "Invalid proxy";

        // Recursively list the contents of the root directory
        //
        cout << "Contents of root directory:" << endl;
        listRecursive(rootDir);
    } catch (const Ice::Exception& ex) {
        cerr << ex << endl;
        status = 1;
    } catch (const char* msg) {
        cerr << msg << endl;
        status = 1;
    }
}

// Clean up
//
if (ic)
    ic->destroy();

return status;
}

```

1. The code includes a few header files:

1. `Ice/Ice.h`

This file is always included in both client and server source files. It provides definitions that are necessary for accessing the Ice run time.

2. `Filesystem.h`

This is the header that is generated by the Slice compiler from the Slide definitions in `Filesystem.ice`.

3. `iostream`

The client uses the `iostream` library to produce its output.

4.iterator

The implementation of `listRecursive` uses an STL iterator.

2. The code adds using declarations for the `std` and `Filesystem` namespaces.
3. The structure of the code in `main` follows what we saw in Chapter 3. After initializing the run time, the client creates a proxy to the root directory of the file system. For this example, we assume that the server runs on the local host and listens using the default protocol (TCP/IP) at port 10000. The object identity of the root directory is known to be `RootDir`.
4. The client down-casts the proxy to `DirectoryPrx` and passes that proxy to `listRecursive`, which prints the contents of the file system.

Most of the work happens in `listRecursive`:

```
// Recursively print the contents of directory "dir" in
// tree fashion. For files, show the contents of each file.
// The "depth" parameter is the current nesting level
// (for indentation).

static void
listRecursive(const DirectoryPrx& dir, int depth = 0)
{
    string indent(++depth, '\t');

    NodeSeq contents = dir->list();

    for (NodeSeq::const_iterator i = contents.begin();
         i != contents.end();
         ++i) {
        DirectoryPrx dir = DirectoryPrx::checkedCast(*i);
        FilePrx file = FilePrx::uncheckedCast(*i);
        cout << indent << (*i)->name()
              << (dir ? " (directory):" : " (file):") << endl;
        if (dir) {
            listRecursive(dir, depth);
        } else {
            Lines text = file->read();
            for (Lines::const_iterator j = text.begin();
                 j != text.end();
                 ++j) {
                cout << indent << "\t" << *j << endl;
            }
        }
    }
}
```



```
        }  
    }  
}
```

The function is passed a proxy to a directory to list, and an indent level. (The indent level increments with each recursive call and allows the code to print the name of each node at an indent level that corresponds to the depth of the tree at that node.) `listRecursive` calls the `list` operation on the directory and iterates over the returned sequence of nodes:

1. The code does a `checkedCast` to narrow the `Node` proxy to a `Directory` proxy, as well as an `uncheckedCast` to narrow the `Node` proxy to a `File` proxy. Exactly one of those casts will succeed, so there is no need to call `checkedCast` twice: if the `Node` *is-a* `Directory`, the code uses the `DirectoryPrx` returned by the `checkedCast`; if the `checkedCast` fails, we *know* that the `Node` *is-a* `File` and, therefore, an `uncheckedCast` is sufficient to get a `FilePrx`.

In general, if you know that a down-cast to a specific type will succeed, it is preferable to use an `uncheckedCast` instead of a `checkedCast` because an `uncheckedCast` does not incur any network traffic.

2. The code prints the name of the file or directory and then, depending on which cast succeeded, prints " (directory) " or " (file) " following the name.
3. The code checks the type of the node:
 - If it is a directory, the code recurses, incrementing the indent level.
 - If it is a file, the code calls the `read` operation on the file to retrieve the file contents and then iterates over the returned sequence of lines, printing each line.

Assume that we have a small file system consisting of two files and a directory as follows:

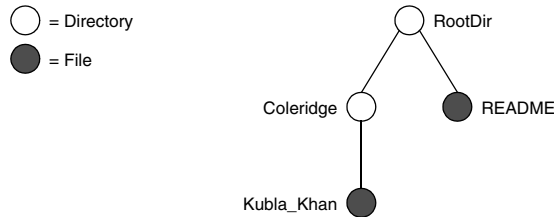

Figure 7.1. A small file system.

The output produced by client for this file system is:

```

Contents of root directory:
  README (file):
    This file system contains a collection of poetry.
  Coleridge (directory):
    Kubla_Khan (file):
      In Xanadu did Kubla Khan
      A stately pleasure-dome decree:
      Where Alph, the sacred river, ran
      Through caverns measureless to man
      Down to a sunless sea.
  
```

Note that, so far, our client (and server) are not very sophisticated:

- The protocol and address information are hard-wired into the code.
- The client makes more remote procedure calls than strictly necessary; with minor redesign of the Slice definitions, many of these calls can be avoided.

We will see how to address these shortcomings in XREF and XREF.

7.3 Summary

This chapter presented a very simple client to access a server that implements the file system we developed in Chapter 5. As you can see, the C++ code hardly differs from the code you would write for an ordinary C++ program. This is one of the biggest advantages of using Ice: accessing a remote object is as easy as accessing an ordinary, local C++ object. This allows you to put your effort where you should, namely, into developing your application logic instead of having to

struggle with arcane networking APIs. As we will see in Chapter 9, this is true for the server side as well, meaning that you can develop distributed applications easily and efficiently.

Chapter 8

Server-Side Slice-to-C++ Mapping

8.1 Chapter Overview

In this chapter, we present the server-side Slice-to-C++ mapping (see Chapter 6 for the client-side mapping). Section 8.3 discusses how to initialize and finalize the server-side run time, sections 8.4 to 8.6 show how to implement interfaces and operations, and Section 8.7 discusses how to register objects with the server-side Ice run time.

8.2 Introduction

The mapping for Slice data types to C++ is identical on the client side and server side. This means that everything in Chapter 6 also applies to the server side. However, for the server side, there are a few additional things you need to know, specifically:

- how to initialize and finalize the server-side run time
- how to implement servants
- how to pass parameters and throw exceptions
- how to create servants and register them with the Ice run time.

We discuss these topics in the remainder of this chapter.

8.3 The Server-Side `main` Function

The main entry point to the Ice run time is represented by the local interface `Ice::Communicator`. As for the client side, you must initialize the Ice run time by calling `Ice::initialize` before you can do anything else in your server. `Ice::initialize` returns a smart pointer to an instance of an `Ice::Communicator`:

```
int
main(int argc, char* argv[])
{
    Ice::CommunicatorPtr ic
        = Ice::initialize(argc, argv);
    // ...
}
```

`Ice::initialize` accepts a C++ reference to `argc` and `argv`. The function scans the argument vector for any command-line options that are relevant to the Ice run time; any such options are removed from the argument vector so, when `Ice::initialize` returns, the only options and arguments remaining are those that concern your application. If anything goes wrong during initialization, `initialize` throws an exception.

Before leaving your `main` function, you *must* call `Communicator::destroy`. The `destroy` operation is responsible for finalizing the Ice run time. In particular, `destroy` waits for any operation invocations that may still be running to complete. In addition, `destroy` ensures that any outstanding threads are joined with and reclaims a number of operating system resources, such as file descriptors and memory. Never allow your `main` function to terminate without calling `destroy` first; doing so has undefined behavior.

The general shape of our server-side `main` function is therefore as follows:

```
#include <Ice/Ice.h>

int
main(int argc, char* argv[])
{
    int status = 0;
    Ice::CommunicatorPtr ic;
    try {
        ic = Ice::initialize(argc, argv);

        // Server code here...
```

```

    } catch (const Ice::Exception& e) {
        cerr << e << endl;
        status = 1;
    } catch (const std::string& msg) {
        cerr << msg << endl;
        status = 1;
    } catch (const char* msg) {
        cerr << msg << endl;
        status = 1;
    }
    if (ic) {
        try {
            ic->destroy();
        } catch (const std::string& msg) {
            cerr << msg << endl;
            status = 1;
        }
    }
    return status;
}

```

Note that the code places the call to `Ice::initialize` in a `try` block and takes care to return the correct exit status to the operating system. Also note that an attempt to destroy the communicator is made only if the initialization succeeded.

The `catch` handlers for `const std::string &` and `const char *` are in place as a convenience feature: if we encounter a fatal error condition anywhere in the server code, we can simply throw a string or a string literal containing an error message; this causes the stack to be unwound back to `main`, at which point the error message is printed and, after destroying the communicator, `main` terminates with non-zero exit status.

8.3.1 The `Ice::Application` Class

The preceding structure for the `main` function is so common that `Ice` offers a class, `Ice::Application`, that encapsulates all the correct initialization and finalization activities. The definition of the class is as follows (with some detail omitted for now):

```

namespace Ice {
    class Application /* ... */ {
    public:
        Application();

```

```

    virtual ~Application();

    int main(int argc, char*[] argv);
    int main(int, char*[], const char* config);
    int main(int argc, char*[] argv,
            const Ice::InitializationData& id);
    virtual int run(int, char*[]) = 0;

    static const char* appName();
    static CommunicatorPtr communicator();
    // ...
};
}

```

The intent of this class is that you specialize `Ice::Application` and implement the pure virtual `run` method in your derived class. Whatever code you would normally place in `main` goes into the `run` method instead. Using `Ice::Application`, our program looks as follows:

```

#include <Ice/Ice.h>

class MyApplication : virtual public Ice::Application {
public:
    virtual int run(int, char*[]) {

        // Server code here...

        return 0;
    }
};

int
main(int argc, char* argv[])
{
    MyApplication app;
    return app.main(argc, argv);
}

```

Note that `Application::main` is overload and can optionally be called with either a configuration file name or an `InitializationData` structure (see Section 31.3 and Section 30.8). If you pass a configuration file name, settings on the command line override settings in the configuration file. The `Application::main` function does the following:

1. It installs an exception handler for `Ice::Exception`. If your code fails to handle an Ice exception, `Application::main` prints the exception details on `stderr` before returning with a non-zero return value.
2. It installs exception handlers for `const std::string &` and `const char *`. This allows you to terminate your server in response to a fatal error condition by throwing a `std::string` or a string literal. `Application::main` prints the string on `stderr` before returning a non-zero return value.
3. It initializes (by calling `Ice::initialize`) and finalizes (by calling `Communicator::destroy`) a communicator. You can get access to the communicator for your server by calling the static `communicator()` member.
4. It scans the argument vector for options that are relevant to the Ice run time and removes any such options. The argument vector that is passed to your run method therefore is free of Ice-related options and only contains options and arguments that are specific to your application.
5. It provides the name of your application via the static `appName` member function. The return value from this call is `argv[0]`, so you can get at `argv[0]` from anywhere in your code by calling `Ice::Application::appName` (which is usually required for error messages).
6. It creates an `IceUtil::CtrlCHandler` that properly destroys the communicator.

Using `Ice::Application` ensures that your program properly finalizes the Ice run time, whether your server terminates normally or in response to an exception or signal. We recommend that all your programs use this class; doing so makes your life easier. In addition, `Ice::Application` also provides features for signal handling and configuration that you do not have to implement yourself when you use this class.

Using `Ice::Application` on the Client Side

You can use `Ice::Application` for your clients as well: simply implement a class that derives from `Ice::Application` and place the client code into its run method. The advantage of this approach is the same as for the server side: `Ice::Application` ensures that the communicator is destroyed correctly even in the presence of exceptions.

Catching Signals

The simple server we developed in Chapter 3 had no way to shut down cleanly: we simply interrupted the server from the command line to force it to exit. Terminating a server in this fashion is unacceptable for many real-life server applications: typically, the server has to perform some cleanup work before terminating, such as flushing database buffers or closing network connections. This is particularly important on receipt of a signal or keyboard interrupt to prevent possible corruption of database files or other persistent data.

To make it easier to deal with signals, `Ice::Application` encapsulates the platform-independent signal handling capabilities provided by the class `IceUtil::CtrlHandler` (see Section 30.11). This allows you to cleanly shut down on receipt of a signal and to use the same source code regardless of the underlying operating system and threading package:

```
namespace Ice {
    class Application : /* ... */ {
    public:
        // ...
        static void destroyOnInterrupt();
        static void shutdownOnInterrupt();
        static void ignoreInterrupt();
        static void holdInterrupt();
        static void releaseInterrupt();
        static bool interrupted();
    };
}
```

You can use `Ice::Application` under both Windows and UNIX: for UNIX, the member functions control the behavior of your application for **SIGINT**, **SIGHUP**, and **SIGTERM**; for Windows, the member functions control the behavior of your application for **CTRL_C_EVENT**, **CTRL_BREAK_EVENT**, **CTRL_CLOSE_EVENT**, **CTRL_LOGOFF_EVENT**, and **CTRL_SHUTDOWN_EVENT**.

The member functions behave as follows:

- `destroyOnInterrupt`

This function creates an `IceUtil::CtrlHandler` that destroys the communicator when one of the monitored signals is raised. This is the default behavior.

- `shutdownOnInterrupt`
This function creates an `IceUtil::CtrlCHandler` that shuts down the communicator when one of the monitored signals is raised.
- `ignoreInterrupt`
This function causes signals to be ignored.
- `holdInterrupt`
This function temporarily blocks signal delivery.
- `releaseInterrupt`
This function restores signal delivery to the previous disposition. Any signal that arrives after `holdInterrupt` was called is delivered when you call `releaseInterrupt`.
- `interrupted`
This function returns `true` if a signal caused the communicator to shut down, `false` otherwise. This allows us to distinguish intentional shutdown from a forced shutdown that was caused by a signal. This is useful, for example, for logging purposes.

By default, `Ice::Application` behaves as if `destroyOnInterrupt` was invoked, therefore our server `main` function requires no change to ensure that the program terminates cleanly on receipt of a signal. However, we add a diagnostic to report the occurrence of a signal, so our `main` function now looks like:

```
#include <Ice/Ice.h>

class MyApplication : virtual public Ice::Application {
public:
    virtual int run(int, char*[]) {

        // Server code here...

        if (interrupted())
            cerr << appName() << ": terminating" << endl;

        return 0;
    }
};

int
main(int argc, char* argv[])
```

```

{
    MyApplication app;
    return app.main(argc, argv);
}

```

Note that, if your server is interrupted by a signal, the Ice run time waits for all currently executing operations to finish. This means that an operation that updates persistent state cannot be interrupted in the middle of what it was doing and cause partial update problems.

Ice::Application and Properties

Apart from the functionality shown in this section, `Ice::Application` also takes care of initializing the Ice run time with property values. Properties allow you to configure the run time in various ways. For example, you can use properties to control things such as the thread pool size or port number for a server. We discuss Ice properties in more detail in Chapter 30.

Limitations of Ice::Application

`Ice::Application` is a singleton class that creates a single communicator. If you are using multiple communicators, you cannot use `Ice::Application`. Instead, you must structure your code as we saw in Chapter 3 (taking care to always destroy the communicators).

8.3.2 The Ice::Service Class

The `Ice::Application` class described in Section 8.3.1 is very convenient for general use by Ice client and server applications. In some cases, however, an application may need to run at the system level as a Unix daemon or Win32 service. For these situations, Ice includes `Ice::Service`, a singleton class that is comparable to `Ice::Application` but also encapsulates the low-level, platform-specific initialization and shutdown procedures common to system services. The `Ice::Service` class is defined as follows:

```

namespace Ice {
    class Service {
    public:
        Service();

        virtual bool shutdown();
        virtual void interrupt();
    };
}

```

```
int main(int&, char*[],
        const Ice::InitializationData& =
        Ice::InitializationData());
Ice::CommunicatorPtr communicator() const;

static Service* instance();

bool service() const;
std::string name() const;
bool checkSystem() const;

int run(int&, char*[], const Ice::InitializationData&);

void configureService(const std::string&);

int installService(const std::string&,
                  const std::string&,
                  const std::string&,
                  const std::vector<std::string>&);
int uninstallService(const std::string&);
int startService(const std::string&,
                const std::vector<std::string>&);
int stopService(const std::string&);

void configureDaemon(bool, bool);

virtual void handleInterrupt(int);

protected:
virtual bool start(int, char*[]) = 0;
virtual void waitForShutdown();
virtual bool stop();
virtual Ice::CommunicatorPtr initializeCommunicator(
    int&, char*[], const Ice::InitializationData&);

virtual void syserror(const std::string&);
virtual void error(const std::string&);
virtual void warning(const std::string&);
virtual void trace(const std::string&);

void enableInterrupt();
void disableInterrupt();

// ...
};
}
```

At a minimum, an Ice application that uses the `Ice::Service` class must define a subclass and override the `start` member function, which is where the service must perform its startup activities, such as processing command-line arguments, creating an object adapter, and registering servants. The application's `main` function must instantiate the subclass and typically invokes its `main` member function, passing the program's argument vector as parameters. The example below illustrates a minimal `Ice::Service` subclass:

```
#include <Ice/Service.h>

class MyService : public Ice::Service {
protected:
    virtual bool start(int, char* []);
private:
    Ice::ObjectAdapterPtr _adapter;
};

bool
MyService::start(int argc, char* argv[])
{
    _adapter = communicator()->createObjectAdapter("MyAdapter");
    _adapter->addWithUUID(new MyServantI);
    _adapter->activate();
    return true;
}

int
main(int argc, char* argv[])
{
    MyService svc;
    return svc.main(argc, argv);
}
```

The `Service::main` member function performs the following sequence of tasks:

1. Scans the argument vector for reserved options that indicate whether the program should run as a system service and removes these options from the argument vector (`argc` is adjusted accordingly). Additional reserved options are supported for administrative tasks.
2. Configures the program for running as a system service (if necessary) by invoking `configureService` or `configureDaemon`, as appropriate for the platform.
3. Invokes the `run` member function and returns its result.

The `Service::run` member function executes the service in the steps shown below:

1. Installs an `IceUtil::CtrlCHandler` (see Section 30.11) for proper signal handling.
2. Invokes the `initializeCommunicator` member function to obtain a communicator. The communicator instance can be accessed using the `communicator` member function.
3. Invokes the `start` member function. If `start` returns `false` to indicate failure, `run` destroys the communicator and returns immediately.
4. Invokes the `waitForShutdown` member function, which should block until shutdown is invoked.
5. Invokes the `stop` member function. If `stop` returns `true`, `run` considers the application to have terminated successfully.
6. Destroys the communicator.
7. Gracefully terminates the system service (if necessary).

If an unhandled exception is caught by `Service::run`, a descriptive message is logged, the communicator is destroyed and the service is terminated.

Ice::Service Member Functions

The virtual member functions in `Ice::Service` represent the points at which a subclass can intercept the service activities. All of the virtual member functions (except `start`) have default implementations.

- `void handleInterrupt(int sig)`
Invoked by the `CtrlCHandler` when a signal occurs. The default implementation ignores the signal if it represents a logoff event and the `Ice.NoHup` property is set to a value larger than zero, otherwise it invokes the `interrupt` member function.
- `Ice::CommunicatorPtr initializeCommunicator(int & argc, char * argv[], const Ice::InitializationData & data)`
Initializes a communicator. The default implementation invokes `Ice::initialize` and passes the given arguments.
- `void interrupt()`
Invoked by the signal handler to indicate a signal was received. The default implementation invokes the `shutdown` member function.

- `bool shutdown()`
Causes the service to begin the shutdown process. The default implementation invokes `shutdown` on the communicator. The subclass must return `true` if shutdown was started successfully, and `false` otherwise.
- `bool start(int argc, char * argv[])`
Allows the subclass to perform its startup activities, such as scanning the provided argument vector for recognized command-line options, creating an object adapter, and registering servants. The subclass must return `true` if startup was successful, and `false` otherwise.
- `bool stop()`
Allows the subclass to clean up prior to termination. The default implementation does nothing but return `true`. The subclass must return `true` if the service has stopped successfully, and `false` otherwise.
- `void syserror(const std::string & msg) const`
- `void error(const std::string & msg) const`
- `void warning(const std::string & msg) const`
- `void trace(const std::string & msg) const`
- `void print(const std::string & msg) const`
Convenience functions for logging messages to the communicator's logger. The `syserror` member function includes a description of the system's current error code.
- `void waitForShutdown()`
Waits indefinitely for the service to shut down. The default implementation invokes `waitForShutdown` on the communicator.

The non-virtual member functions shown in the class definition are described below:

- `bool checkSystem() const`
Returns `true` if the operating system supports Win32 services or Unix daemons. This function returns `false` on Windows 95/98/ME.
- `Ice::CommunicatorPtr communicator() const`
Returns the communicator used by the service, as created by `initializeCommunicator`.
- `void configureDaemon(bool chdir, bool close)`
Configures the program to run as a Unix daemon. The `chdir` parameter determines whether the daemon changes its working directory to the root

directory. The `close` parameter determines whether the daemon closes unnecessary file descriptors (i.e., `stdin`, `stdout`, etc.).

- `void configureService(const std::string & name)`
Configures the program to run as a Win32 service with the given name.
- `void disableInterrupt()`
Disables the signal handling behavior in `Ice::Service`. When disabled, signals are ignored.
- `void enableInterrupt()`
Enables the signal handling behavior in `Ice::Service`. When enabled, the occurrence of a signal causes the `handleInterrupt` member function to be invoked.
- `int installService(const std::string & name,
 const std::string & display,
 const std::string & executable,
 const std::vector<std::string> & args)`
Registers the program as a Win32 service with the given name. If the `display` parameter is non-empty, it is used as the display name for the service, otherwise the service name is used. If the `executable` parameter is non-empty, it is used as the pathname of the executable, otherwise the pathname of the current executable is used. The values in `args` are passed to the service as command-line arguments at startup. This vector should typically include an option to notify the program that it is being started as a service. The function returns `EXIT_SUCCESS` for success, `EXIT_FAILURE` for failure.
- `static Service * instance()`
Returns the singleton `Ice::Service` instance.
- `int main(int & argc, char * argv[],
 const Ice::InitializationData & data =
 Ice::InitializationData())`
The primary entry point of the `Ice::Service` class. The tasks performed by this function are described earlier in this section. The function returns `EXIT_SUCCESS` for success, `EXIT_FAILURE` for failure.
- `std::string name() const`
Returns the name of the service. If the program is running as a Win32 service, the return value is the Win32 service name, otherwise it returns the value of `argv[0]`.

- `int run(int & argc, char * argv[],
const Ice::InitializationData & data)`

Alternative entry point for applications that prefer a different style of service configuration. The program must invoke `configureService` (Win32) or `configureDaemon` (Unix) in order to run as a service. The tasks performed by this function are described earlier in this section. The function returns `EXIT_SUCCESS` for success, `EXIT_FAILURE` for failure.

- `bool service() const`

Returns true if the program is running as a Win32 service or Unix daemon, or false otherwise.

- `int startService(const std::string & name,
const std::vector<std::string> & args)`

Starts the Win32 service using the Service Control Manager. The values in `args` are passed to the service as command-line options at startup. The function returns `EXIT_SUCCESS` for success, `EXIT_FAILURE` for failure.

- `int stopService(const std::string & name)`

Stops the Win32 service using the Service Control Manager. The function returns `EXIT_SUCCESS` for success, `EXIT_FAILURE` for failure.

- `int uninstallService(const std::string & name)`

Removes a Win32 service using the Service Control Manager. The function returns `EXIT_SUCCESS` for success, `EXIT_FAILURE` for failure.

Unix Daemons

On Unix platforms, `Ice::Service` recognizes the following command-line options:

- **--daemon**

Indicates that the program should run as a daemon. This involves the creation of a background child process in which `Service::main` performs its tasks. The parent process does not terminate until the child process has successfully invoked the `start` member function¹. Unless instructed otherwise, `Ice::Service` changes the current working directory of the child process to the root directory, and closes all unnecessary file descriptors. Note that the

1. This behavior avoids the uncertainty often associated with starting a daemon from a shell script, because it ensures that the command invocation does not complete until the daemon is ready to receive requests.

file descriptors are not closed until after the communicator is initialized, meaning standard input, standard output, and standard error are available for use during this time. For example, the IceSSL plug-in may need to prompt for a passphrase on standard input, or Ice may print the child's process id on standard output if the property `Ice.PrintProcessId` is set.

- **--noclose**

Prevents `Ice::Service` from closing unnecessary file descriptors. This can be useful during debugging and diagnosis because it provides access to the output from the daemon's standard output and standard error.

- **--nochdir**

Prevents `Ice::Service` from changing the current working directory.

The **--noclose** and **--nochdir** options can only be specified in conjunction with **--daemon**. These options are removed from the argument vector that is passed to the `start` member function.

Win32 Services

On Win32 platforms², `Ice::Service` starts the application as a Windows service if the **--service** option is specified:

- **--service NAME**

Run as a Windows service named **NAME**. This option is removed from the argument vector that is passed to the `start` member function.

Before an application can run as a Windows service, however, it must be installed, therefore the `Ice::Service` class supports several additional command-line options for performing administrative duties:

- **--install NAME [--display DISP] [--executable EXEC] [ARG ...]**

Installs the service **NAME**. If the **--display** option is specified, use **DISP** as the display name of the service, otherwise use **NAME**. If the **--executable** option is specified, use **EXEC** as the service executable pathname, otherwise use the pathname of the executable used to invoke **--install**. Any additional arguments are passed unchanged to the `Service::start` member function. Note that this command automatically adds the command-line

2. Windows services are not supported on Windows 95/98/ME.

option `--service NAME` to the set of arguments passed to the service at startup, therefore it is not necessary to specify those options explicitly.

- `--uninstall NAME`

Removes the service **NAME**. If the service is currently active, it must be stopped before it can be uninstalled.

- `--start NAME [ARG ...]`

Starts the service **NAME**. Any additional arguments are passed unchanged to the `Service::start` member function.

- `--stop NAME`

Stops the service **NAME**.

An error occurs if more than one administrative command is specified, or if the `--service` option is specified in conjunction with an administrative command. The program terminates immediately after executing the administrative command.

The `Ice::Service` class supports the Windows service control codes `SERVICE_CONTROL_INTERROGATE` and `SERVICE_CONTROL_STOP`. Upon receipt of `SERVICE_CONTROL_STOP`, `Ice::Service` invokes the `shutdown` member function.

Logging Considerations

When an application is running as a Unix daemon or Windows service, the default implementation of `Ice::Logger` is usually not appropriate because its output is sent to standard error and is therefore lost. The application can implement a custom logger, or it can use one of the alternatives provided by Ice:

- On Unix, the `Ice.UseSyslog` property selects a logger implementation that uses the `syslog` facility.
- On Windows, the `Ice.UseEventLog` property causes log messages to be recorded in the Windows event log. The logger implementation automatically adds the necessary key to the registry to enable the service to use the event log. Alternatively, the default logger can be used in conjunction with the `Ice.StdErr` property to redirect standard error to a file.

Note that when preparing to start a Windows service, `Ice::Service` may encounter errors before the communicator is initialized. If no logger is supplied in the `InitializationData` argument to `main`, `Ice::Service` creates a temporary instance of the Windows event logger to use until the communicator is successfully initialized and the communicator's configured logger can be used instead. Therefore, even if a failing service is configured to use a different logger

implementation, useful diagnostic information may have been recorded in the Windows event log.

If an `Ice::Service` subclass needs to supply an alternate logger implementation, the subclass can provide it using the `InitializationData` argument to `main`, or the subclass can override the `initializeCommunicator` member function.

Troubleshooting Win32 Service Failures

One failure that commonly occurs when starting a Windows service is caused by missing DLLs, which usually results in an error window stating a particular DLL cannot be found. Fixing this problem can often be a trial-and-error process because the DLL mentioned in the error may depend on other DLLs that are also missing. It is important to understand that a Windows service is launched by the operating system and can be configured to execute as a different user, which means the service's environment (most importantly its `PATH`) may not match yours and therefore extra steps are necessary to ensure that the service can locate its required DLLs³.

The simplest approach is to copy all of the necessary DLLs to the directory containing the service executable. If this solution is undesirable, another option is to modify the system `PATH` to include the directory or directories containing the required DLLs. (Note that modifying the system `PATH` requires restarting the system.) Finally, you can copy the necessary DLLs to `\WINDOWS\system32`, although we do not recommend this approach⁴.

Assuming that DLL issues are resolved, a Windows service can fail to start for a number of other reasons, including

- invalid command-line arguments or configuration properties
- inability to access necessary resources such as filesystems and databases, because either the resources do not exist or the service does not have sufficient access rights to them

3. The command-line utility `dumpbin` can be used to discover the dependencies of an executable or DLL.

4. Copying DLLs to `\WINDOWS\system32` often results in subtle problems later when trying to develop using newer versions of the DLLs. Inevitably you will forget about the DLLs in `\WINDOWS\system32` and struggle to determine why your application is misbehaving or failing to start.

- networking issues, such as attempting to open a port that is already in use, or DNS lookup failures

Failures encountered by the Ice run time prior to initialization of the communicator are reported to the Windows event log if no other logger implementation is defined, so that should be the first place you look. Typically you will find an entry in the System event log resembling the following message:

```
The IcePatch2 service terminated with service-specific error 1.
```

Error code 1 corresponds to `EXIT_FAILURE`, the value used by `Ice::Service` to indicate a failure during startup. Additional diagnostic messages may be available in the Application event log. See page 270 for more information on configuring a logger for a Windows service.

As we mentioned earlier, insufficient access rights can also prevent a Windows service from starting successfully. By default, a Windows service is configured to run under a local system account, in which case the service may not be able to access resources owned by other users. It may be necessary for you to configure a service to run under a different account, which you can do using the Services control panel.

8.4 Mapping for Interfaces

The server-side mapping for interfaces provides an up-call API for the Ice run time: by implementing virtual functions in a servant class, you provide the hook that gets the thread of control from the Ice server-side run time into your application code.

8.4.1 Skeleton Classes

On the client side, interfaces map to proxy classes (see Section 6.11). On the server side, interfaces map to *skeleton* classes. A skeleton is a class that has a pure virtual member function for each operation on the corresponding interface. For example, consider the Slice definition for the `Node` interface we defined in Chapter 5 once more:

```
module Filesystem {
    interface Node {
        nonmutating string name();
    };
    // ...
};
```

The Slice compiler generates the following definition for this interface:

```
namespace Filesystem {

    class Node : virtual public Ice::Object {
    public:
        virtual std::string name(const Ice::Current& =
                                Ice::Current()) const = 0;

        // ...
    };
    // ...
}
```

For the moment, we will ignore a number of other member functions of this class. The important points to note are:

- As for the client side, Slice modules are mapped to C++ namespaces with the same name, so the skeleton class definition is nested in the namespace `Filesystem`.
- The name of the skeleton class is the same as the name of the Slice interface (`Node`).
- The skeleton class contains a pure virtual member function for each operation in the Slice interface.
- The skeleton class is an abstract base class because its member functions are pure virtual.
- The skeleton class inherits from `Ice::Object` (which forms the root of the Ice object hierarchy).

8.4.2 Servant Classes

In order to provide an implementation for an Ice object, you must create a servant class that inherits from the corresponding skeleton class. For example, to create a servant for the `Node` interface, you could write:

```
#include <Filesystem.h> // Slice-generated header

class NodeI : public virtual Filesystem::Node {
public:
    NodeI(const std::string&);
    virtual std::string name(const Ice::Current&) const;
private:
    std::string _name;
};
```

By convention, servant classes have the name of their interface with an I-suffix, so the servant class for the Node interface is called NodeI. (This is a convention only: as far as the Ice run time is concerned, you can chose any name you prefer for your servant classes.)

Note that NodeI inherits from Filesystem::Node, that is, it derives from its skeleton class. It is a good idea to always use virtual inheritance when defining servant classes. Strictly speaking, virtual inheritance is necessary only for servants that implement interfaces that use multiple inheritance; however, the virtual keyword does no harm and, if you add multiple inheritance to an interface hierarchy half-way through development, you do not have to go back and add a virtual keyword to all your servant classes.

As far as Ice is concerned, the NodeI class must implement only a single member function: the pure virtual name function that it inherits from its skeleton. This makes the servant class a concrete class that can be instantiated. You can add other member functions and data members as you see fit to support your implementation. For example, in the preceding definition, we added a _name member and a constructor. Obviously, the constructor initializes the _name member and the name function returns its value:

```
NodeI::NodeI(const std::string& name) : _name(name)
{
}

std::string
NodeI::name(const Ice::Current&) const
{
    return _name;
}
```

Normal, idempotent, and nonmutating Operations

The name member function of the NodeI skeleton on page 274 is a const member function. The const keyword is added by the Slice compiler because

name is a nonmutating operation (see Section 3.8.1). In contrast, normal operations and idempotent operations are non-const member functions. For example, the following interface contains a normal operation, an idempotent operation, and a nonmutating operation:

```
interface Example {
    void normalOp();
    idempotent void idempotentOp();
    nonmutating void nonmutatingOp();
};
```

The skeleton class for this interface looks like this:

```
class Example : virtual public Ice::Object {
public:
    virtual void normalOp(const Ice::Current&
                          = Ice::Current()) = 0;
    virtual void idempotentOp(const Ice::Current&
                              = Ice::Current()) = 0;
    virtual void nonmutatingOp(const Ice::Current&
                                = Ice::Current()) const = 0;
    // ...
};
```

Note that only the nonmutating operation is mapped as a const member function; normal and idempotent operations are ordinary member functions.

8.5 Parameter Passing

For each parameter of a Slice operation, the C++ mapping generates a corresponding parameter for the virtual member function in the skeleton. In addition, every operation has an additional, trailing parameter of type `Ice::Current`. For example, the name operation of the Node interface has no parameters, but the name member function of the Node skeleton class has a single parameter of type `Ice::Current`. We explain the purpose of this parameter in Section 31.6 and will ignore it for now.

Parameter passing on the server side follows the rules for the client side:

- in-parameters are passed by value or const reference.
- out-parameters are passed by reference.
- return values are passed by value

To illustrate the rules, consider the following interface that passes string parameters in all possible directions:

```
module M {
    interface Example {
        string op(string sin, out string sout);
    };
};
```

The generated skeleton class for this interface looks as follows:

```
namespace M {
    class Example : virtual public ::Ice::Object {
    public:
        virtual std::string
            op(const std::string&, std::string&,
              const Ice::Current& = Ice::Current()) = 0;
        // ...
    };
}
```

As you can see, there are no surprises here. For example, we could implement `op` as follows:

```
std::string
ExampleI::op(const std::string& sin,
             std::string& sout,
             const Ice::Current&)
{
    cout << sin << endl;           // In parameters are initialized
    sout = "Hello World!";        // Assign out parameter
    return "Done";                // Return a string
}
```

This code is in no way different from what you would normally write if you were to pass strings to and from a function; the fact that remote procedure calls are involved does not impact on your code in any way. The same is true for parameters of other types, such as proxies, classes, or dictionaries: the parameter passing conventions follow normal C++ rules and do not require special-purpose API calls or memory management.⁵

5. This is in sharp contrast to the CORBA C++ mapping, which has very complex parameter passing rules that make it all too easy to leak memory or cause undefined behavior.

8.6 Raising Exceptions

To throw an exception from an operation implementation, you simply instantiate the exception, initialize it, and throw it. For example:

```
void
Filesystem::FileI::write(const Filesystem::Lines& text,
                        const Ice::Current&)
{
    // Try to write the file contents here...
    // Assume we are out of space...
    if (error) {
        Filesystem::GenericError e;
        e.reason = "file too large";
        throw e;
    }
};
```

No memory management issues arise in the presence of exceptions.

Note that the Slice compiler never generates exception specifications for operations, regardless of whether the corresponding Slice operation definition has an exception specification or not. This is deliberate: C++ exception specifications do not add any value and are therefore not used by the Ice C++ mapping. (See [22] for an excellent treatment of the problems associated with C++ exception specifications.)

If you throw an arbitrary C++ exception (such as an `int` or other unexpected type), the Ice run time catches the exception and then returns an `UnknownException` to the client. Similarly, if you throw an “impossible” user exception (a user exception that is not listed in the exception specification of the operation), the client receives an `UnknownUserException`.

If you throw a run-time exception, such as `MemoryLimitException`, the client receives an `UnknownLocalException`.⁶ For that reason, you should never throw system exceptions from operation implementations. If you do, all the client will see is an `UnknownLocalException`, which does not tell the client anything useful.

6. There are three system exceptions that are not changed to `UnknownLocalException` when returned to the client: `ObjectNotExistException`, `OperationNotExistException`, and `FacetNotExistException`. We discuss these exceptions in more detail in Section 4.10.4 and Chapter 33.

8.7 Object Incarnation

Having created a servant class such as the rudimentary `NodeI` class in Section 8.4.2, you can instantiate the class to create a concrete servant that can receive invocations from a client. However, merely instantiating a servant class is insufficient to incarnate an object. Specifically, to provide an implementation of an Ice object, you must follow the following steps:

1. Instantiate a servant class.
2. Create an identity for the Ice object incarnated by the servant.
3. Inform the Ice run time of the existence of the servant.
4. Pass a proxy for the object to a client so the client can reach it.

8.7.1 Instantiating a Servant

Instantiating a servant means to allocate an instance on the heap:

```
NodePtr servant = new NodeI("Fred");
```

This code creates a new `NodeI` instance on the heap and assigns its address to a smart pointer of type `NodePtr` (see also page 232). This works because `NodeI` is derived from `Node`, so a smart pointer of type `NodePtr` can also look after an instance of type `NodeI`. However, if we want to invoke a member function of the derived `NodeI` class at this point, we have a problem: we cannot access member functions of the derived `NodeI` class through a `NodePtr` smart pointer, only member functions of `Node` base class. (The C++ type rules prevent us from accessing a member of a derived class through a pointer to a base class.) To get around this, we can modify the code as follows:

```
typedef IceUtil::Handle<NodeI> NodeIPtr;  
NodeIPtr servant = new NodeI("Fred");
```

This code makes use of the smart pointer template we presented in Section 6.14.6 by defining `NodeIPtr` as a smart pointer to `NodeI` instances. Whether you use a smart pointer of type `NodePtr` or `NodeIPtr` depends solely on whether you want to invoke a member function of the `NodeI` derived class; if you only want to invoke member functions that are defined in the `Node` skeleton base class, it is sufficient to use a `NodePtr` and you need not define the `NodeIPtr` type.

Whether you use `NodePtr` or `NodeIPtr`, the advantages of using a smart pointer class should be obvious from the discussion in Section 6.14.6: they make it impossible to accidentally leak memory.

8.7.2 Creating an Identity

Each Ice object requires an identity. That identity must be unique for all servants using the same object adapter.⁷ An Ice object identity is a structure with the following Slice definition:

```
module Ice {
    struct Identity {
        string name;
        string category;
    };
    // ...
};
```

The full identity of an object is the combination of both the name and category fields of the Identity structure. For now, we will leave the category field as the empty string and simply use the name field. (See Section 31.7 for a discussion of the category field.)

To create an identity, we simply assign a key that identifies the servant to the name field of the Identity structure:

```
Ice::Identity id;
id.name = "Fred"; // Not unique, but good enough for now
```

8.7.3 Activating a Servant

Merely creating a servant instance does nothing: the Ice run time becomes aware of the existence of a servant only once you explicitly tell the object adapter about the servant. To activate a servant, you invoke the add operation on the object adapter. Assuming that we have access to the object adapter in the `_adapter` variable, we can write:

```
_adapter->add(servant, id);
```

Note the two arguments to `add`: the smart pointer to the servant and the object identity. Calling `add` on the object adapter adds the servant pointer and the servant's identity to the adapter's servant map and links the proxy for an Ice object to the correct servant instance in the server's memory as follows:

7. The Ice object model assumes that all objects (regardless of their adapter) have a globally unique identity. See XREF for further discussion.

1. The proxy for an Ice object, apart from addressing information, contains the identity of the Ice object. When a client invokes an operation, the object identity is sent with the request to the server.
2. The object adapter receives the request, retrieves the identity, and uses the identity as an index into the servant map.
3. If a servant with that identity is active, the object adapter retrieves the servant pointer from the servant map and dispatches the incoming request into the correct member function on the servant.

Assuming that the object adapter is in the active state (see Section 31.4.5), client requests are dispatched to the servant as soon as you call `add`.

Servant Life Time and Reference Counts

Putting the preceding points together, we can write a simple function that instantiates and activates one of our `NodeI` servants. For this example, we use a simple helper function called `activateServant` that creates and activates a servant with a given identity:

```
void
activateServant(const string& name)
{
    NodePtr servant = new NodeI(name);           // Refcount == 1
    Ice::Identity id;
    id.name = name;
    _adapter->add(servant, id);                 // Refcount == 2
}                                              // Refcount == 1
```

Note that we create the servant on the heap and that, once `activateServant` returns, we lose the last remaining handle to the servant (because the `servant` variable goes out of scope). The question is, what happens to the heap-allocated servant instance? The answer lies in the smart pointer semantics:

- When the new servant is instantiated, its reference count is initialized to 0.
- Assigning the servant's address to the `servant` smart pointer increments the servant's reference count to 1.
- Calling `add` passes the `servant` smart pointer to the object adapter which keeps a copy of the handle internally. This increments the reference count of the servant to 2.
- When `activateServant` returns, the destructor of the `servant` variable decrements the reference count of the servant to 1.

The net effect is that the servant is retained on the heap with a reference count of 1 for as long as the servant is in the servant map of its object adapter. (If we deactivate the servant, that is, remove it from the servant map, the reference count drops to zero and the memory occupied by the servant is reclaimed; we discuss these life cycle issues in XREF.)

8.7.4 UUIDs as Identities

As we discussed in Section 2.5.1, the Ice object model assumes that object identities are globally unique. One way of ensuring that uniqueness is to use UUIDs (Universally Unique Identifiers) [14] as identities. The `IceUtil` namespace contains a helper function to create such identities:

```
#include <IceUtil/UUID.h>
#include <iostream>

using namespace std;

int
main()
{
    cout << IceUtil::generateUUID() << endl;
}
```

When executed, this program prints a unique string such as `5029a22c-e333-4f87-86b1-cd5e0fcce509`. Each call to `generateUUID` creates a string that differs from all previous ones.⁸ You can use a UUID such as this to create object identities. For convenience, the object adapter has an operation `addWithUUID` that generates a UUID and adds a servant to the servant map in a single step. Using this operation, we can rewrite the code on page 280 like this:

```
void
activateServant(const string& name)
{
    NodePtr servant = new NodeI(name);
    _adapter->addWithUUID(servant);
}
```

8. Well, almost: eventually, the UUID algorithm wraps around and produces strings that repeat themselves, but this will not happen until approximately the year 3400.

8.7.5 Creating Proxies

Once we have activated a servant for an Ice object, the server can process incoming client requests for that object. However, clients can only access the object once they hold a proxy for the object. If a client knows the server's address details and the object identity, it can create a proxy from a string, as we saw in our first example in Chapter 3. However, creation of proxies by the client in this manner is usually only done to allow the client access to initial objects for bootstrapping. Once the client has an initial proxy, it typically obtains further proxies by invoking operations.

The object adapter contains all the details that make up the information in a proxy: the addressing and protocol information, and the object identity. The Ice run time offers a number of ways to create proxies. Once created, you can pass a proxy to the client as the return value or as an out-parameter of an operation invocation.

Proxies and Servant Activation

The `add` and `addWithUUID` servant activation operations on the object adapter return a proxy for the corresponding Ice object. This means we can write:

```
typedef IceUtil::Handle<NodeI> NodeIPtr;
NodeIPtr servant = new NodeI(name);
NodePrx proxy = NodePrx::uncheckedCast(
    _adapter->addWithUUID(servant));

// Pass proxy to client...
```

Here, `addWithUUID` both activates the servant and returns a proxy for the Ice object incarnated by that servant in a single step.

Note that we need to use an `uncheckedCast` here because `addWithUUID` returns a proxy of type `Ice::ObjectPrx`.

Direct Proxy Creation

The object adapter offers an operation to create a proxy for a given identity:

```
module Ice {
    local interface ObjectAdapter {
        Object* createProxy(Identity id);
        // ...
    };
};
```

Note that `createProxy` creates a proxy for a given identity whether a servant is activated with that identity or not. In other words, proxies have a life cycle that is quite independent from the life cycle of servants:

```
Ice::Identity id;
id.name = IceUtil::generateUUID();
ObjectPrx o = _adapter->createProxy(id);
```

This creates a proxy for an Ice object with the identity returned by `generateUUID`. Obviously, no servant yet exists for that object so, if we return the proxy to a client and the client invokes an operation on the proxy, the client will receive an `ObjectNotExistException`. (We examine these life cycle issues in more detail in XREF.)

8.8 Summary

This chapter presented the server-side C++ mapping. Because the mapping for Slice data types is identical for clients and servers, the server-side mapping only adds a few additional mechanism to the client side: a small API to initialize and finalize the run time, plus a few rules for how to derive servant classes from skeletons and how to register servants with the server-side run time.

Even though the examples in this chapter are very simple, they accurately reflect the basics of writing an Ice server. Of course, for more sophisticated servers (which we discuss in Chapter 31), you will be using additional APIs, for example, to improve performance or scalability. However, these APIs are all described in Slice, so, to use these APIs, you need not learn any C++ mapping rules beyond those we described here.

Chapter 9

Developing a File System Server in C++

9.1 Chapter Overview

In this chapter, we present the source code for a C++ server that implements the file system we developed in Chapter 5 (see Chapter 7 for the corresponding client). The code we present here is fully functional, apart from the required interlocking for threads. (We examine threading issues in detail in Chapter 30.)

9.2 Implementing a File System Server

We have now seen enough of the server-side C++ mapping to implement a server for the file system we developed in Chapter 5. (You may find it useful to review the Slice definition for our file system in Section 5 before studying the source code.)

Our server is composed of two source files:

- `Server.cpp`

This file contains the server main program.

- `FilesystemI.cpp`

This file contains the implementation for the file system servants.

9.2.1 The Server main Program

Our server main program, in the file `Server.cpp`, uses the `Ice::Application` class we discussed in Section 8.3.1. The `run` method installs a signal handler, creates an object adapter, instantiates a few servants for the directories and files in the file system, and then activates the adapter. This leads to a main program as follows:

```
#include <FilesystemI.h>
#include <Ice/Application.h>

using namespace std;
using namespace Filesystem;

class FilesystemApp : virtual public Ice::Application {
public:
    virtual int run(int, char*[]) {
        // Create an object adapter (stored in the NodeI::_adapter
        // static member)
        //
        NodeI::_adapter =
            communicator()->createObjectAdapterWithEndpoints(
                "SimpleFilesystem", "default -p 10000");

        // Create the root directory (with name "/" and no parent)
        //
        DirectoryIPtr root = new DirectoryI("/", 0);

        // Create a file called "README" in the root directory
        //
        FilePtr file = new FileI("README", root);
        Lines text;
        text.push_back("This file system contains"
            "a collection of poetry.");
        file->write(text);

        // Create a directory called "Coleridge" in
        // the root directory
        //
        DirectoryIPtr coleridge
            = new DirectoryI("Coleridge", root);

        // Create a file called "Kubla_Khan" in the
        // Coleridge directory
        //
        file = new FileI("Kubla_Khan", coleridge);
```

```

text.erase(text.begin(), text.end());
text.push_back("In Xanadu did Kubla Khan");
text.push_back("A stately pleasure-dome decree:");
text.push_back("Where Alph, the sacred river, ran");
text.push_back("Through caverns measureless to man");
text.push_back("Down to a sunless sea.");
file->write(text);

// All objects are created, allow client requests now
//
NodeI::_adapter->activate();

// Wait until we are done
//
communicator()->waitForShutdown();
if (interrupted()) {
    cerr << appName()
         << ": received signal, shutting down" << endl;
}
NodeI::_adapter = 0;
return 0;
};

};

int
main(int argc, char* argv[])
{
    FilesystemApp app;
    return app.main(argc, argv);
}

```

There is quite a bit of code here, so let us examine each section in detail:

```

#include <FilesystemI.h>
#include <Ice/Application.h>

using namespace std;
using namespace Filesystem;

```

The code includes the header file `FilesystemI.h` (see page 296). That file includes `Ice/Ice.h` as well as the header file that is generated by the Slice compiler, `Filesystem.h`. Because we are using `Ice::Application`, we need to include `Ice/Application.h` as well.

Two using declarations, for the namespaces `std` and `Filesystem`, permit us to be a little less verbose in the source code.

The next part of the source code is the definition of `FilesystemApp`, which derives from `Ice::Application` and contains the main application logic in its `run` method:

```
class FilesystemApp : virtual public Ice::Application {
public:
    virtual int run(int, char*[]) {
        // Create an object adapter (stored in the NodeI::_adapter
        // static member)
        //
        NodeI::_adapter =
            communicator()->createObjectAdapterWithEndpoints(
                "SimpleFilesystem", "default -p 10000");

        // Create the root directory (with name "/" and no parent)
        //
        DirectoryIPtr root = new DirectoryI("/", 0);

        // Create a file called "README" in the root directory
        //
        FilePtr file = new FileI("README", root);
        Lines text;
        text.push_back("This file system contains"
            "a collection of poetry.");
        file->write(text);

        // Create a directory called "Coleridge" in
        // the root directory
        //
        DirectoryIPtr coleridge
            = new DirectoryI("Coleridge", root);

        // Create a file called "Kubla_Khan" in the
        // Coleridge directory
        //
        file = new FileI("Kubla_Khan", coleridge);
        text.erase(text.begin(), text.end());
        text.push_back("In Xanadu did Kubla Khan");
        text.push_back("A stately pleasure-dome decree:");
        text.push_back("Where Alph, the sacred river, ran");
        text.push_back("Through caverns measureless to man");
        text.push_back("Down to a sunless sea.");
        file->write(text);

        // All objects are created, allow client requests now
        //
    }
};
```

```

NodeI::_adapter->activate();

// Wait until we are done
//
communicator()->waitForShutdown();
if (interrupted()) {
    cerr << appName()
        << ": received signal, shutting down" << endl;
}
NodeI::_adapter = 0;
return 0;
};
};
};

```

Much of this code is boiler plate that we saw previously: we create an object adapter, and, towards the end, activate the object adapter and call `waitForShutdown`. (Setting `_adapter` to zero before returning prevents a warning from the Ice run time about Ice objects that persist beyond the life time of the communicator.)

The interesting part of the code follows the adapter creation: here, the server instantiates a few nodes for our file system to create the structure shown in Figure 9.1.

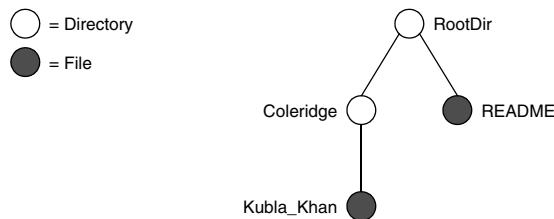

Figure 9.1. A small file system.

As we will see shortly, the servants for our directories and files are of type `DirectoryI` and `FileI`, respectively. The constructor for either type of servant accepts two parameters, the name of the directory or file to be created and a handle to the servant for the parent directory. (For the root directory, which has no parent, we pass a null parent handle.) Thus, the statement

```
DirectoryIPtr root = new DirectoryI("/", 0);
```

creates the root directory, with the name `" / "` and no parent directory. Note that we use the smart pointer class we discussed in Section 6.14.6 to hold the return

value from `new`; that way, we avoid any memory management issues. The type `DirectoryIPtr` is defined as follows in a header file `FilesystemI.h` (see page 296):

```
typedef IceUtil::Handle<DirectoryI> DirectoryIPtr;
```

Here is the code that establishes the structure in Figure 9.1:

```
// Create the root directory (with name "/" and no parent)
//
DirectoryIPtr root = new DirectoryI("/", 0);

// Create a file called "README" in the root directory
//
FilePtr file = new FileI("README", root);
Lines text;
text.push_back("This file system contains"
               "a collection of poetry.");
file->write(text);

// Create a directory called "Coleridge" in
// the root directory
//
DirectoryIPtr coleridge
    = new DirectoryI("Coleridge", root);

// Create a file called "Kubla_Khan" in the
// Coleridge directory
//
file = new FileI("Kubla_Khan", coleridge);
text.erase(text.begin(), text.end());
text.push_back("In Xanadu did Kubla Khan");
text.push_back("A stately pleasure-dome decree:");
text.push_back("Where Alph, the sacred river, ran");
text.push_back("Through caverns measureless to man");
text.push_back("Down to a sunless sea.");
file->write(text);
```

We first create the root directory and a file `README` within the root directory. (Note that we pass the handle to the root directory as the parent pointer when we create the new node of type `FileI`.)

The next step is to fill the file with text:

```
FilePtr file = new FileI("README", root);
Lines text;
text.push_back("This file system contains"
              "a collection of poetry.");
file->write(text);
```

Recall from Section 6.7.3 that Slice sequences map to STL vectors. The Slice type `Lines` is a sequence of strings, so the C++ type `Lines` is a vector of strings; we add a line of text to our `README` file by calling `push_back` on that vector.

Finally, we call the Slice `write` operation on our `FileI` servant by simply writing:

```
file->write(text);
```

This statement is interesting: the server code invokes an operation on one of its own servants. Because the call happens via a smart class pointer (of type `FilePtr`) and *not* via a proxy (of type `FilePrx`), the Ice run time does not know that this call is even taking place—such a direct call into a servant is not mediated by the Ice run time in any way and is dispatched as an ordinary C++ function call.

In similar fashion, the remainder of the code creates a subdirectory called `Coleridge` and, within that directory, a file called `Kubla_Khan` to complete the structure in Figure 9.1.

9.2.2 The Servant Class Definitions

We must provide servants for the concrete interfaces in our Slice specification, that is, we must provide servants for the `File` and `Directory` interfaces in the C++ classes `FileI` and `DirectoryI`. This means that our servant classes might look as follows:

```
namespace Filesystem {
    class FileI : virtual public File {
        // ...
    };

    class DirectoryI : virtual public Directory {
        // ...
    };
}
```

This leads to the C++ class structure as shown in Figure 9.2.

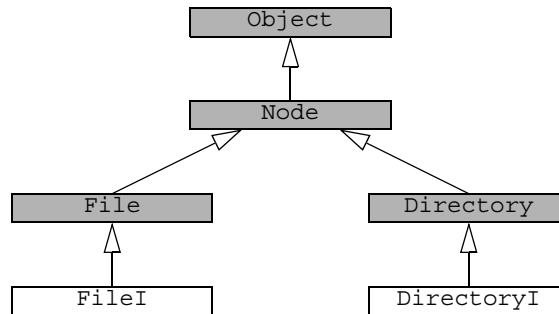

Figure 9.2. File system servants using interface inheritance.

The shaded classes in Figure 9.2 are skeleton classes and the unshaded classes are our servant implementations. If we implement our servants like this, `FileI` must implement the pure virtual operations it inherits from the `File` skeleton (`read` and `write`), as well as the operation it inherits from the `Node` skeleton (`name`). Similarly, `DirectoryI` must implement the pure virtual function it inherits from the `Directory` skeleton (`list`), as well as the operation it inherits from the `Node` skeleton (`name`). Implementing the servants in this way uses interface inheritance from `Node` because no implementation code is inherited from that class.

Alternatively, we can implement our servants using the following definitions:

```

namespace Filesystem {
    class NodeI : virtual public Node {
        // ...
    };

    class FileI : virtual public File,
                 virtual public NodeI {
        // ...
    };

    class DirectoryI : virtual public Directory,
                     virtual public NodeI {
        // ...
    };
}

```



```

};

class DirectoryI : virtual public Directory,
                  virtual public NodeI {
public:
    virtual NodeSeq list(const Ice::Current&) const;
};
}

```

This simply adds signatures for the operation implementations to each class. (Note that the signatures must exactly match the operation signatures in the generated skeleton classes—if they do not match exactly, you end up overloading the pure virtual function in the base class instead of overriding it, meaning that the servant class cannot be instantiated because it will still be abstract. To avoid signature mismatches, you can copy the signatures from the generated header file (`Filesystem.h`.)

Now that we have the basic structure in place, we need to think about other methods and data members we need to support our servant implementation. Typically, each servant class hides the copy constructor and assignment operator, and has a constructor to provide initial state for its data members. Given that all nodes in our file system have both a name and a parent directory, this suggests that the `NodeI` class should implement the functionality relating to tracking the name of each node, as well as the parent–child relationships:

```

namespace Filesystem {
    class DirectoryI;
    typedef IceUtil::Handle<DirectoryI> DirectoryIPtr;

    class NodeI : virtual public Node {
public:
    virtual std::string name(const Ice::Current&) const;
    NodeI(const std::string&, const DirectoryIPtr& parent);
    static Ice::ObjectAdapterPtr _adapter;
private:
    const std::string _name;
    DirectoryIPtr _parent;
    NodeI(const NodeI&);           // Copy forbidden
    void operator=(const NodeI&); // Assignment forbidden
};
}

```

The `NodeI` class has a private data member to store its name (of type `std::string`) and its parent directory (of type `DirectoryIPtr`). The constructor accepts parameters that set the value of these data members. For the

root directory, by convention, we pass a null handle to the constructor to indicate that the root directory has no parent. We have also added a public static variable to hold a smart pointer to the (single) object adapter we use in our server; that variable is initialized by the `Filesystem::run` method on page 288.

The `FileI` servant class must store the contents of its file, so it requires a data member for this. We can conveniently use the generated `Lines` type (which is a `std::vector<std::string>`) to hold the file contents, one string for each line. Because `FileI` inherits from `NodeI`, it also requires a constructor that accepts the file name and the parent directory, leading to the following class definition:

```
namespace Filesystem {
    class FileI : virtual public File,
                 virtual public NodeI {
    public:
        virtual Lines read(const Ice::Current&) const;
        virtual void write(const Lines&,
                          const Ice::Current&);
        FileI(const std::string&, const DirectoryIPtr&);
    private:
        Lines _lines;
    };
}
```

For directories, each directory must store its list of child nodes. We can conveniently use the generated `NodeSeq` type (which is a `vector<NodePrx>`) to do this. Because `DirectoryI` inherits from `NodeI`, we need to add a constructor to initialize the directory name and its parent directory. As we will see shortly, we also need a private helper function, `addChild`, to make it easier to connect a newly created directory to its parent. This leads to the following class definition:

```
namespace Filesystem {
    class DirectoryI : virtual public Directory,
                     virtual public NodeI {
    public:
        virtual NodeSeq list(const Ice::Current&) const;
        DirectoryI(const std::string&, const DirectoryIPtr&);
        void addChild(NodePrx child);
    private:
        NodeSeq _contents;
    };
}
```

Putting all this together, we end up with a servant header file, `FilesystemI.h`, as follows:

```
#include <Ice/Ice.h>
#include <Filesystem.h>

namespace Filesystem {
    class DirectoryI;
    typedef IceUtil::Handle<DirectoryI> DirectoryIPtr;

    class NodeI : virtual public Node {
    public:
        virtual std::string name(const Ice::Current&) const;
        NodeI(const std::string&, const DirectoryIPtr& parent);
        static Ice::ObjectAdapterPtr _adapter;
    private:
        const std::string _name;
        DirectoryIPtr _parent;
        NodeI(const NodeI&);           // Copy forbidden
        void operator=(const NodeI&); // Assignment forbidden
    };

    class FileI : virtual public File,
                  virtual public NodeI {
    public:
        virtual Lines read(const Ice::Current&) const;
        virtual void write(const Lines&,
                           const Ice::Current&);
        FileI(const std::string&, const DirectoryIPtr&);
    private:
        Lines _lines;
    };

    class DirectoryI : virtual public Directory,
                      virtual public NodeI {
    public:
        virtual NodeSeq list(const Ice::Current&) const;
        DirectoryI(const std::string&, const DirectoryIPtr&);
        void addChild(NodePrx child);
    private:
        NodeSeq _contents;
    };
}
```



```

{
}

void
Filesystem::DirectoryI::addChild(const NodePrx child)
{
    _contents.push_back(child);
}

```

The only noteworthy thing is the implementation of `addChild`: when a new directory or file is created, the constructor of the `NodeI` base class calls `addChild` on its own parent, passing it the proxy to the newly-created child. The implementation of `addChild` appends the passed reference to the contents list of the directory it is invoked on (which is the parent directory).

Implementing `NodeI`

The name operation of our `NodeI` class is again trivial: it simply returns the `_name` data member:

```

std::string
Filesystem::NodeI::name(const Ice::Current&) const
{
    return _name;
}

```

Most of the meat of our implementation is in the `NodeI` constructor. It is here that we create the proxy for each node and connect parent and child nodes:

```

Filesystem::NodeI::NodeI(const string& name,
                        const DirectoryIPtr& parent
                        ) : _name(name), _parent(parent)
{
    // Create an identity. The parent has the
    // fixed identity "RootDir"
    //
    Ice::Identity myID = _adapter.getCommunicator()->
        stringToIdentity(parent ? IceUtil::generateUUID()
                        : "RootDir");

    // Create a proxy for the new node and add it as
    // a child to the parent
    //
    NodePrx thisNode
        = NodePrx::uncheckedCast(_adapter->createProxy(myID));
    if (parent)

```



```

        parent->addChild(thisNode);

        // Activate the servant
        //
        _adapter->add(this, myID);
    }

```

The first step is to create a unique identity for each node. For the root directory, we use the fixed identity "RootDir". This allows the client to create a proxy for the root directory (see Section 7.2). For directories other than the root directory, we use a UUID as the identity (see page 281).

The next step is to create a proxy for the child and to add the child to the parent directory's content list by calling `addChild`. This connects the child to the parent.

Finally, we need to activate the servant so the Ice run time knows about the servant's existence, so we call `add` on the object adapter.

This completes our servant implementation. The complete source code is shown here once more:

```

#include <FilesystemI.h>
#include <IceUtil/UUID.h>

using namespace std;

Ice::ObjectAdapterPtr Filesystem::NodeI::_adapter;

// Slice Node::name() operation

std::string
Filesystem::NodeI::name(const Ice::Current&) const
{
    return _name;
}

// NodeI constructor

Filesystem::NodeI::NodeI(const string& name,
                        const DirectoryIPtr& parent
                        ) : _name(name), _parent(parent)
{
    // Create an identity. The parent has the
    // fixed identity "RootDir"
    //
    Ice::Identity myID = _adapter.getCommunicator->
        stringToIdentity(parent ? IceUtil::generateUUID()

```

```
        : "RootDir");

    // Create a proxy for the new node and add it
    // as a child to the parent
    //
    NodePrx thisNode
        = NodePrx::uncheckedCast(_adapter->createProxy(myID));
    if (parent)
        parent->addChild(thisNode);

    // Activate the servant
    //
    _adapter->add(this, myID);
}

// Slice File::read() operation

Filesystem::Lines
Filesystem::FileI::read(const Ice::Current&) const
{
    return _lines;
}

// Slice File::write() operation

void
Filesystem::FileI::write(const Filesystem::Lines& text,
                        const Ice::Current&)
{
    _lines = text;
}

// FileI constructor

Filesystem::FileI::FileI(const string& name,
                        const DirectoryIPtr& parent
                        ) : NodeI(name, parent)
{
}

// Slice Directory::list() operation

Filesystem::NodeSeq
Filesystem::DirectoryI::list(const Ice::Current&) const
{
    return _contents;
}
```

```
    }

    // DirectoryI constructor

    Filesystem::DirectoryI::DirectoryI(const string& name,
                                       const DirectoryIPtr& parent
                                       ) : NodeI(name, parent)
    {
    }

    // addChild is called by the child in order to add
    // itself to the _contents member of the parent

    void
    Filesystem::DirectoryI::addChild(const NodePrx child)
    {
        _contents.push_back(child);
    }
}
```

9.3 Summary

This chapter showed how to implement a complete server for the file system we defined in Chapter 5. Note that the server is remarkably free of code that relates to distribution: most of the server code is simply application logic that would be present just the same for a non-distributed version. Again, this is one of the major advantages of Ice: distribution concerns are kept away from application code so that you can concentrate on developing application logic instead of networking infrastructure.

Note that the server code we presented here is not quite correct as it stands: if two clients access the same file in parallel, each via a different thread, one thread may read the `_lines` data member while another thread updates it. Obviously, if that happens, we may write or return garbage or, worse, crash the server. However, it is trivial to make the `read` and `write` operations thread-safe: a single data member and two lines of source code are sufficient to achieve this. We discuss how to write thread-safe servant implementations in Chapter 30.

Part III.B

Java Mapping

Chapter 10

Client-Side Slice-to-Java Mapping

10.1 Chapter Overview

In this chapter, we present the client-side Slice-to-Java mapping (see Chapter 12 for the server-side mapping). One part of the client-side Java mapping concerns itself with rules for representing each Slice data type as a corresponding Java type; we cover these rules in Section 10.3 to Section 10.10. Another part of the mapping deals with how clients can invoke operations, pass and receive parameters, and handle exceptions. These topics are covered in Section 10.11 to Section 10.13. Slice classes have the characteristics of both data types and interfaces and are covered in Section 10.14. In Section 10.15, we show how you can customize the Slice-to-Java mapping using metadata. Section 10.16 lists the command-line options for the Slice-to-Java compiler. Finally, Section 10.17 covers the use of Slice checksums in the Java mapping.

10.2 Introduction

The client-side Slice-to-Java mapping defines how Slice data types are translated to Java types, and how clients invoke operations, pass parameters, and handle errors. Much of the Java mapping is intuitive. For example, Slice sequences map

to Java arrays, so there is essentially nothing new you have learn in order to use Slice sequences in Java.

The Java API to the Ice run time is fully thread-safe. Obviously, you must still synchronize access to data from different threads. For example, if you have two threads sharing a sequence, you cannot safely have one thread insert into the sequence while another thread is iterating over the sequence. However, you only need to concern yourself with concurrent access to your own data—the Ice run time itself is fully thread safe, and none of the Ice API calls require you to acquire or release a lock before you safely can make the call.

Much of what appears in this chapter is reference material. We suggest that you skim the material on the initial reading and refer back to specific sections as needed. However, we recommend that you read at least Section 10.9 to Section 10.13 in detail because these sections cover how to call operations from a client, pass parameters, and handle exceptions.

A word of advice before you start: in order to use the Java mapping, you should need no more than the Slice definition of your application and knowledge of the Java mapping rules. In particular, looking through the generated code in order to discern how to use the Java mapping is likely to be inefficient, due to the amount of detail. Of course, occasionally, you may want to refer to the generated code to confirm a detail of the mapping, but we recommend that you otherwise use the material presented here to see how to write your client-side code.

10.3 Mapping for Identifiers

Slice identifiers map to an identical Java identifier. For example, the Slice identifier `Clock` becomes the Java identifier `Clock`. There is one exception to this rule: if a Slice identifier is the same as a Java keyword, the corresponding Java identifier is prefixed with an underscore. For example, the Slice identifier `while` is mapped as `_while`.¹

A single Slice identifier often results in several Java identifiers. For example, for a Slice interface named `Foo`, the generated Java code uses the identifiers `Foo` and `FooPrx` (among others). If the interface has the name `while`, the generated

1. As suggested in Section 4.5.3 on page 86, you should try to avoid such identifiers as much as possible.

identifiers are `_while` and `whilePrx` (*not* `_whilePrx`), that is, the underscore prefix is applied only to those generated identifiers that actually require it.

10.4 Mapping for Modules

Slice modules map to Java packages with the same name as the Slice module. The mapping preserves the nesting of the Slice definitions. For example:

```
// Definitions at global scope here...

module M1 {
    // Definitions for M1 here...
    module M2 {
        // Definitions for M2 here...
    };
};

// ...

module M1 { // Reopen M1
    // More definitions for M1 here...
};
```

This definition maps to the corresponding Java definitions:

```
package M1;
// Definitions for M1 here...

package M1.M2;
// Definitions for M2 here...

package M1;
// Definitions for M1 here...
```

Note that these definitions appear in the appropriate source files; source files for definitions in module M1 are generated in directory M1 underneath the top-level directory, and source files for definitions for module M2 are generated in directory M1/M2 underneath the top-level directory. You can set the top-level output directory using the `--output-dir` option with `slice2java` (see Section 4.19).

10.5 The Ice Package

All of the APIs for the Ice run time are nested in the `Ice` package, to avoid clashes with definitions for other libraries or applications. Some of the contents of the `Ice` package are generated from Slice definitions; other parts of the `Ice` package provide special-purpose definitions that do not have a corresponding Slice definition. We will incrementally cover the contents of the `Ice` package throughout the remainder of the book.

10.6 Mapping for Simple Built-In Types

The Slice built-in types are mapped to Java types as shown in Table 10.1.

Table 10.1. Mapping of Slice built-in types to Java.

Slice	Java
<code>bool</code>	<code>boolean</code>
<code>byte</code>	<code>byte</code>
<code>short</code>	<code>short</code>
<code>int</code>	<code>int</code>
<code>long</code>	<code>long</code>
<code>float</code>	<code>float</code>
<code>double</code>	<code>double</code>
<code>string</code>	<code>String</code>

10.7 Mapping for User-Defined Types

Slice supports user-defined types: enumerations, structures, sequences, and dictionaries.

10.7.1 Mapping for Enumerations

Java2 does not have an enumerated type, so the Slice enumerations are emulated using a Java class: the name of the Slice enumeration becomes the name of the Java class; for each enumerator, the class contains two public final members, one with the same name as the enumerator, and one with the same name as the enumerator with a prepended underscore. For example:

```
enum Fruit { Apple, Pear, Orange };
```

The generated Java class looks as follows:

```
public final class Fruit {
    public static final int _Apple = 0;
    public static final int _Pear = 1;
    public static final int _Orange = 2;

    public static final Fruit Apple = new Fruit(_Apple);
    public static final Fruit Pear = new Fruit(_Pear);
    public static final Fruit Orange = new Fruit(_Orange);

    public int
    value() {
        // ...
    }

    public static Fruit
    convert(int val) {
        // ...
    }

    public static Fruit
    convert(String val) {
        // ...
    }

    // ...
}
```

Note that the generated class contains a number of other members, which we have not shown. These members are internal to the Ice run time and you must not use them in your application code (because they may change from release to release).

Given the above definitions, we can use enumerated values as follows:

```

Fruit favoriteFruit = Fruit.Apple;
Fruit otherFavoriteFruit = Fruit.Orange;

if (favoriteFruit == Fruit.Apple) // Compare with constant
    // ...

if (f1 == f2)                    // Compare two enums
    // ...

switch (f2.value()) {           // Switch on enum
case Fruit._Apple:
    // ...
    break;
case Fruit._Pear
    // ...
    break;
case Fruit._Orange
    // ...
    break;
}

```

As you can see, the generated class enables natural use of enumerated values. The `int` members with a prepended underscore are constants that encode each enumerator; the `Fruit` members are preinitialized enumerators that you can use for initialization and comparison.

The `value` and `convert` methods act as an accessor and a modifier, so you can read and write the value of an enumerated variable as an `int`. If you are using the `convert` method, you must make sure that the passed value is within the range of the enumeration; failure to do so will result in an assertion failure:

```
Fruit favoriteFruit = Fruit.convert(4); // Assertion failure!
```

See Section 10.15.2 for information on the Java5 mapping for Slice enumerations.

10.7.2 Mapping for Structures

Slice structures map to Java structures with the same name. For each Slice data member, the Java class contains a corresponding public data member. For example, here is our `Employee` structure from Section 4.9.4 once more:

```

struct Employee {
    long number;
    string firstName;
    string lastName;
};

```

The Slice-to-Java compiler generates the following definition for this structure:

```
public final class Employee implements java.lang.Cloneable {
    public long number;
    public String firstName;
    public String lastName;

    public Employee {}

    public Employee(long number,
                    String firstName,
                    String lastName) {
        this.number = number;
        this.firstName = firstName;
        this.lastName = lastName;
    }

    public boolean equals(java.lang.Object rhs) {
        // ...
    }

    public int hashCode() {
        // ...
    }

    public java.lang.Object clone()
        java.lang.Object o;
        try
        {
            o = super.clone();
        }
        catch(java.lang.CloneNotSupportedException ex)
        {
            assert false; // impossible
        }
        return o;
    }
}
```

For each data member in the Slice definition, the Java class contains a corresponding public data member of the same name. Refer to Section 10.15.4 for additional information on data members.

The `equals` member function compares two structures for equality. Note that the generated class also provides the usual `hashCode` and `clone` methods. (`clone` has the default behavior of making a shallow copy.)

The Java class also has a default constructor as well as a second constructor that accepts one argument for each data member of the structure. This constructor allows you to construct and initialize a structure in a single statement (instead of having to first instantiate the structure and then initialize its members).

10.7.3 Mapping for Sequences

Slice sequences map to Java arrays. This means that the Slice-to-Java compiler does not generate a separate named type for a Slice sequence. For example:

```
sequence<Fruit> FruitPlatter;
```

This definition simply corresponds to the Java type `Fruit []`. Naturally, because Slice sequences are mapped to Java arrays, you can take advantage of all the array functionality provided by Java, such as initialization, assignment, cloning, and the `length` member. For example:

```
Fruit[] platter = { Fruit.Apple, Fruit.Pear };  
assert(platter.length == 2);
```

See Section 10.15 for information on alternate mappings for sequence types.

10.7.4 Mapping for Dictionaries

Here is the definition of our `EmployeeMap` from Section 4.9.4 once more:

```
dictionary<long, Employee> EmployeeMap;
```

As for sequences, the Java mapping does not create a separate named type for this definition. Instead, *all* dictionaries are simply of type `java.util.Map`, so we can use a map of employee structures like any other Java map. (Of course, because `java.util.Map` is an abstract class, we must use a concrete class, such as `java.util.HashMap` for the actual map.) For example:

```
java.util.Map em = new java.util.HashMap();  
  
Employee e = new Employee();  
e.number = 31;  
e.firstName = "James";  
e.lastName = "Gosling";  
  
em.put(new Long(e.number), e);
```

See Section 10.15 for information on alternate mappings for dictionary types.

10.8 Mapping for Constants

Here are the constant definitions we saw in Section 4.9.5 on page 97 once more:

```
const bool      AppendByDefault = true;
const byte      LowerNibble = 0x0f;
const string    Advice = "Don't Panic!";
const short     TheAnswer = 42;
const double    PI = 3.1416;
```

```
enum Fruit { Apple, Pear, Orange };
const Fruit    FavoriteFruit = Pear;
```

Here are the generated definitions for these constants:

```
public interface AppendByDefault {
    boolean value = true;
}

public interface LowerNibble {
    byte value = 15;
}

public interface Advice {
    String value = "Don't Panic!";
}

public interface TheAnswer {
    short value = 42;
}

public interface PI {
    double value = 3.1416;
}

public interface FavoriteFruit {
    Fruit value = Fruit.Pear;
}
```

As you can see, each Slice constant is mapped to a Java interface with the same name as the constant. The interface contains a member named `value` that holds the value of the constant.

10.9 Mapping for Exceptions

Here is a fragment of the Slice definition for our world time server from Section 4.10.5 on page 113 once more:

```
exception GenericError {
    string reason;
};
exception BadTimeVal extends GenericError {};
exception BadZoneName extends GenericError {};
```

These exception definitions map as follows:

```
public class GenericError extends Ice.UserException {
    public String reason;

    public GenericError() {}

    public GenericError(String reason)
    {
        this.reason = reason;
    }

    public String ice_name() {
        return "GenericError";
    }
}

public class BadTimeVal extends GenericError {
    public String ice_name() {
        return "BadTimeVal";
    }
}

public class BadZoneName extends GenericError {
    public String ice_name() {
        return "BadZoneName";
    }
}
```

Each Slice exception is mapped to a Java class with the same name. For each data member, the corresponding class contains a public data member. (Obviously, because `BadTimeVal` and `BadZoneName` do not have members, the generated

classes for these exceptions also do not have members.) Refer to Section 10.15.4 for additional information on data members.

The inheritance structure of the Slice exceptions is preserved for the generated classes, so `BadTimeVal` and `BadZoneName` inherit from `GenericError`.

Exceptions have a default constructor as well as a second constructor that accepts one argument for each exception member. This constructor allows you to instantiate and initialize an exception in a single statement, instead of having to first instantiate the exception and then assign to its members. (For derived exceptions, the constructor accepts one argument for each base exception member, plus one argument for each derived exception member, in base-to-derived order.)

Each exception also defines the `ice_name` member function, which returns the name of the exception.

All user exceptions are derived from the base class `Ice.UserException`. This allows you to catch all user exceptions generically by installing a handler for `Ice.UserException`. `Ice.UserException`, in turn, derives from `java.lang.Exception`.

`Ice.UserExceptions` implements a `clone` method that is inherited by its derived exceptions, so you can make memberwise shallow copies of exceptions.

Note that the generated exception classes contain other member functions that are not shown. However, those member functions are internal to the Java mapping and are not meant to be called by application code.

10.10 Mapping for Run-Time Exceptions

The Ice run time throws run-time exceptions for a number of pre-defined error conditions. All run-time exceptions directly or indirectly derive from `Ice.LocalException` (which, in turn, derives from `java.lang.RuntimeException`).

`Ice.LocalExceptions` implements a `clone` method that is inherited by its derived exceptions, so you can make memberwise shallow copies of exceptions.

An inheritance diagram for user and run-time exceptions appears in Figure 4.4 on page 110. By catching exceptions at the appropriate point in the hierarchy, you can handle exceptions according to the category of error they indicate:

- `Ice.LocalException`

This is the root of the inheritance tree for run-time exceptions.

- `Ice.UserException`
This is the root of the inheritance tree for user exceptions.
- `Ice.TimeoutException`
This is the base exception for both operation-invocation and connection-establishment timeouts.
- `Ice.ConnectTimeoutException`
This exception is raised when the initial attempt to establish a connection to a server times out.

You will probably have little need to catch the remaining exceptions by category; the fine-grained error handling offered by the remainder of the hierarchy is of interest mainly in the implementation of the Ice run time. However, there is one exception you will probably be interested in specifically:

`Ice.ObjectNotExistException`. This exception is raised if a client invokes an operation on an Ice object that no longer exists. In other words, the client holds a dangling reference to an object that probably existed some time in the past but has since been permanently destroyed.

10.11 Mapping for Interfaces

Slice interfaces map to proxies on the client side. A proxy is simply a Java interface with operations that correspond to the operations defined in the Slice interface.

The compiler generates quite few source files for each Slice interface. In general, for an interface `<interface-name>`, the following source files are created by the compiler:

- `<interface-name>.java`
This source file declares the `<interface-name>` Java interface.
- `<interface-name>Holder.java`
This source file defines a holder type for the interface (see page 327).
- `<interface-name>Prx.java`
This source file defines the `<interface-name>Prx` interface (see page 317).

- `<interface-name>PrxHelper.java`
This source file defines the helper type for the interface's proxy (see page 320).
- `<interface-name>PrxHolder.java`
This source file defines the a holder type for the interface's proxy (see page 327).
- `_<interface-name>Operations.java`
`_<interface-name>OperationsNC.java`
These source files each define an interface that contains the operations corresponding to the Slice interface.

These are the files that contain code that is relevant to the client side. The compiler also generates a file that is specific to the server side, plus three additional files:

- `_<interface-name>Disp.java`
This file contains the definition of the server-side skeleton class.
- `_<interface-name>Del.java`
- `_<interface-name>DelD.java`
- `_<interface-name>DelM.java`
These files contain code that is internal to the Java mapping; they do not contain any functions of relevance to application programmers.

10.11.1 Proxy Interfaces

On the client side, Slice interfaces map to Java interfaces with member functions that correspond to the operations on those interfaces. Consider the following simple interface:

```
interface Simple {
    void op();
};
```

The Slice compiler generates the following definition for use by the client:

```
public interface SimplePrx extends Ice.ObjectPrx {
    public void op();
    public void op(java.util.Map __context);
}
```

As you can see, the compiler generates a *proxy interface* `SimplePrx`. In general, the generated name is `<interface-name>Prx`. If an interface is nested in a module `M`, the generated class is part of package `M`, so the fully-qualified name is `M.<interface-name>Prx`.

In the client's address space, an instance of `SimplePrx` is the local ambassador for a remote instance of the `Simple` interface in a server and is known as a *proxy instance*. All the details about the server-side object, such as its address, what protocol to use, and its object identity are encapsulated in that instance.

Note that `SimplePrx` inherits from `Ice.ObjectPrx`. This reflects the fact that all `Ice` interfaces implicitly inherit from `Ice::Object`.

For each operation in the interface, the proxy class has a member function of the same name. For the preceding example, we find that the operation `op` has been mapped to the member function `op`. Also note that `op` is overloaded: the second version of `op` has a parameter `__context` of type `java.util.Map`. This parameter is for use by the `Ice` run time to store information about how to deliver a request. You normally do not need to use it. (We examine the `__context` parameter in detail in Chapter 31. The parameter is also used by `IceStorm`—see Chapter 43.)

Because all the `<interface-name>Prx` types are interfaces, you cannot instantiate an object of such a type. Instead, proxy instances are always instantiated on behalf of the client by the `Ice` run time, so client code never has any need to instantiate a proxy directly. The proxy references handed out by the `Ice` run time are always of type `<interface-name>Prx`; the concrete implementation of the interface is part of the `Ice` run time and does not concern application code.

10.11.2 The `Ice.ObjectPrx` Interface

All `Ice` objects have `Object` as the ultimate ancestor type, so all proxies inherit from `Ice.ObjectPrx`. `ObjectPrx` provides a number of methods:

```
package Ice;

public interface ObjectPrx {
    boolean equals(java.lang.Object r);
    Identity ice_getIdentity();
    int ice_getHash();
    boolean ice_isA(String __id);
    String ice_id();
    void ice_ping();
    // ...
}
```

The methods behave as follows:

- `equals`

This operation compares two proxies for equality. Note that all aspects of proxies are compared by this operation, such as the communication endpoints for the proxy. This means that, in general, if two proxies compare unequal, that does *not* imply that they denote different objects. For example, if two proxies denote the same Ice object via different transport endpoints, `equals` returns `false` even though the proxies denote the same object.

- `ice_getIdentity`

This method returns the identity of the object denoted by the proxy. The identity of an Ice object has the following Slice type:

```
module Ice {
    struct Identity {
        string name;
        string category;
    };
};
```

To see whether two proxies denote the same object, first obtain the identity for each object and then compare the identities:

```
Ice.ObjectPrx o1 = ...;
Ice.ObjectPrx o2 = ...;
Ice.Identity i1 = o1.ice_getIdentity();
Ice.Identity i2 = o2.ice_getIdentity();

if (i1.equals(i2))
    // o1 and o2 denote the same object
else
    // o1 and o2 denote different objects
```

- `ice_getHash`

This method returns a hash key for the proxy.

- `ice_isA`

This method determines whether the object denoted by the proxy supports a specific interface. The argument to `ice_isA` is a type ID (see Section 4.13). For example, to see whether a proxy of type `ObjectPrx` denotes a `Printer` object, we can write:

```
Ice.ObjectPrx o = ...;
if (o != null && o.ice_isA("::Printer"))
```

```

        // o denotes a Printer object
    else
        // o denotes some other type of object

```

Note that we are testing whether the proxy is null before attempting to invoke the `ice_isA` method. This avoids getting a `NullPointerException` if the proxy is null.

- `ice_id`

This method returns the type ID of the object denoted by the proxy. Note that the type returned is the type of the actual object, which may be more derived than the static type of the proxy. For example, if we have a proxy of type `BasePrx`, with a static type ID of `::Base`, the return value of `ice_id` might be `::Base`, or it might something more derived, such as `::Derived`.

- `ice_ping`

This method provides a basic reachability test for the object. If the object can physically be contacted (that is, the object exists and its server is running and reachable), the call completes normally; otherwise, it throws an exception that indicates why the object could not be reached, such as

`ObjectNotExistException` or `ConnectTimeoutException`.

Note that there are other methods in `ObjectPrx`, not shown here. These methods provide different ways to dispatch a call. (We discuss these methods in Chapter 31.)

10.11.3 Proxy Helpers

For each Slice interface, apart from the proxy interface, the Slice-to-Java compiler creates a helper class: for an interface `Simple`, the name of the generated helper class is `SimplePrxHelper`. The helper classes contains two methods of to support down-casting:

```

public final class SimplePrxHelper
    extends Ice.ObjectPrxHelper implements SimplePrx {
    public static SimplePrx checkedCast(Ice.ObjectPrx b) {
        // ...
    }

    public static SimplePrx checkedCast(Ice.ObjectPrx b,
                                        Ice.Context ctx) {
        // ...
    }
}

```

```

    public static SimplePrx uncheckedCast (Ice.ObjectPrx b) {
        // ...
    }

    // ...
}

```

Both the `checkedCast` and `uncheckedCast` methods implement a down-cast: if the passed proxy is a proxy for an object of type `Simple`, or a proxy for an object with a type derived from `Simple`, the cast returns a non-null reference to a proxy of type `SimplePrx`; otherwise, if the passed proxy denotes an object of a different type (or if the passed proxy is null), the cast returns a null reference.

Given a proxy of any type, you can use a `checkedCast` to determine whether the corresponding object supports a given type, for example:

```

Ice.ObjectPrx obj = ...;           // Get a proxy from somewhere...

SimplePrx simple = SimplePrxHelper.checkedCast(obj);
if (simple != null)
    // Object supports the Simple interface...
else
    // Object is not of type Simple...

```

Note that a `checkedCast` contacts the server. This is necessary because only the implementation of a proxy in the server has definite knowledge of the type of an object. As a result, a `checkedCast` may throw a `ConnectTimeoutException` or an `ObjectNotExistException`. (This also explains the need for the helper class: the Ice run time must contact the server, so we cannot use a Java down-cast.)

In contrast, an `uncheckedCast` does not contact the server and unconditionally returns a proxy of the requested type. However, if you do use an `uncheckedCast`, you must be certain that the proxy really does support the type you are casting to; otherwise, if you get it wrong, you will most likely get a run-time exception when you invoke an operation on the proxy. The most likely error for such a type mismatch is `OperationNotExistException`. However, other exceptions, such as a marshaling exception are possible as well. And, if the object happens to have an operation with the correct name, but different parameter types, no exception may be reported at all and you simply end up sending the invocation to an object of the wrong type; that object may do rather non-sensical things. To illustrate this, consider the following two interfaces:

```

interface Process {
    void launch(int stackSize, int dataSize);
};

// ...

interface Rocket {
    void launch(float xCoord, float yCoord);
};

```

Suppose you expect to receive a proxy for a `Process` object and use an `uncheckedCast` to down-cast the proxy:

```

Ice.ObjectPrx obj = ...; // Get proxy...
ProcessPrx process
    = ProcessPrxHelper.uncheckedCast(obj); // No worries...
process.launch(40, 60); // Oops...

```

If the proxy you received actually denotes a `Rocket` object, the error will go undetected by the Ice run time: because `int` and `float` have the same size and because the Ice protocol does not tag data with its type on the wire, the implementation of `Rocket::launch` will simply misinterpret the passed integers as floating-point numbers.

In fairness, this example is somewhat contrived. For such a mistake to go unnoticed at run time, both objects must have an operation with the same name and, in addition, the run-time arguments passed to the operation must have a total marshaled size that matches the number of bytes that are expected by the unmarshaling code on the server side. In practice, this is extremely rare and an incorrect `uncheckedCast` typically results in a run-time exception.

A final warning about down-casts: you must use either a `checkedCast` or an `uncheckedCast` to down-cast a proxy. If you use a Java cast, the behavior is undefined.

10.11.4 Object Identity and Proxy Comparison

Proxies provide an `equals` method that compares proxies:

```

interface ObjectPrx {
    boolean equals(java.lang.Object r);
}

```

Note that proxy comparison with `equals` uses *all* of the information in a proxy for the comparison. This means that not only the object identity must match for a comparison to succeed, but other details inside the proxy, such as the protocol and

endpoint information, must be the same. In other words, comparison with `equals` tests for *proxy* identity, *not* object identity. A common mistake is to write code along the following lines:

```
Ice.ObjectPrx p1 = ...;           // Get a proxy...
Ice.ObjectPrx p2 = ...;           // Get another proxy...

if (p1.equals(p2)) {
    // p1 and p2 denote different objects      // WRONG!
} else {
    // p1 and p2 denote the same object        // Correct
}
```

Even though `p1` and `p2` differ, they may denote the same Ice object. This can happen because, for example, both `p1` and `p2` embed the same object identity, but each use a different protocol to contact the target object. Similarly, the protocols may be the same, but denote different endpoints (because a single Ice object can be contacted via several different transport endpoints). In other words, if two proxies compare equal with `equals`, we know that the two proxies denote the same object (because they are identical in all respects); however, if two proxies compare unequal with `equals`, we know absolutely nothing: the proxies may or may not denote the same object.

To compare the object identities of two proxies, you must use a helper function in the `Ice.Util` class:

```
package Ice;

public final class Util {
    public static int proxyIdentityCompare(ObjectPrx lhs,
                                           ObjectPrx rhs);
    public static int proxyIdentityAndFacetCompare(ObjectPrx lhs,
                                                    ObjectPrx rhs);
    // ...
}
```

`proxyIdentityCompare` allows you to correctly compare proxies for identity:

```
Ice.ObjectPrx p1 = ...;           // Get a proxy...
Ice.ObjectPrx p2 = ...;           // Get another proxy...

if (Ice.Util.proxyIdentityCompare(p1, p2) != 0) {
```

```

    // p1 and p2 denote different objects      // Correct
} else {
    // p1 and p2 denote the same object      // Correct
}

```

The function returns 0 if the identities are equal, -1 if p1 is less than p2, and 1 if p1 is greater than p2. (The comparison uses name as the major and category as the minor sort key.)

The `proxyIdentityAndFacetCompare` performs the same function, but compares both the identity and the facet name (see Chapter 33).

In addition, the Java mapping provides two wrapper classes that allow you to wrap proxies to use as the key of a hashed collection:

```

package Ice;

public class ProxyIdentityKey {
    public ProxyIdentityKey(Ice.ObjectPrx proxy);
    public int hashCode();
    public boolean equals(java.lang.Object obj);
    public Ice.ObjectPrx getProxy();
}

public class ProxyIdentityFacetKey {
    public ProxyIdentityFacetKey(Ice.ObjectPrx proxy);
    public int hashCode();
    public boolean equals(java.lang.Object obj);
    public Ice.ObjectPrx getProxy();
}

```

The constructor caches the identity and the hash code of the passed proxy, so calls to `hashCode` and `equals` can be evaluated efficiently. The `getProxy` method returns the proxy that was passed to the constructor.

As for the comparison functions, `ProxyIdentityKey` only uses the proxy's identity, whereas `ProxyIdentityFacetKey` also includes the facet name.

10.12 Mapping for Operations

As we saw in Section 10.11, for each operation on an interface, the proxy class contains a corresponding member function with the same name. To invoke an operation, you call it via the proxy. For example, here is part of the definitions for our file system from Section 5.4:

```

module Filesystem {
    interface Node {
        nonmutating string name();
    };
    // ...
};

```

The name operation returns a value of type string. Given a proxy to an object of type Node, the client can invoke the operation as follows:

```

NodePrx node = ...;           // Initialize proxy
String name = node.name();    // Get name via RPC

```

This illustrates the typical pattern for receiving return values: return values are returned by reference for complex types, and by value for simple types (such as int or double).

10.12.1 Normal, idempotent, and nonmutating Operations

You can add an idempotent or nonmutating qualifier to a Slice operation. As far as the signature for the corresponding proxy methods is concerned, neither idempotent nor nonmutating have any effect. For example, consider the following interface:

```

interface Example {
    string op1();
    idempotent string op2();
    nonmutating string op3();
};

```

The proxy interface for this is:

```

public interface ExamplePrx extends Ice.ObjectPrx {
    public String op1();
    public String op2();
    public String op3();
}

```

idempotent and nonmutating affect an aspect of call dispatch, not interface, so it makes sense for the three methods to look the same.

10.12.2 Passing Parameters

In-Parameters

The parameter passing rules for the Java mapping are very simple: parameters are passed either by value (for simple types) or by reference (for complex types and type `String`). Semantically, the two ways of passing parameters are identical: it is guaranteed that the value of a parameter will not be changed by the invocation (with some caveats—see XREF).

Here is an interface with operations that pass parameters of various types from client to server:

```
struct NumberAndString {
    int x;
    string str;
};

sequence<string> StringSeq;

dictionary<long, StringSeq> StringTable;

interface ClientToServer {
    void op1(int i, float f, bool b, string s);
    void op2(NumberAndString ns, StringSeq ss, StringTable st);
    void op3(ClientToServer* proxy);
};
```

The Slice compiler generates the following proxy for this definition:

```
public interface ClientToServerPrx extends Ice.ObjectPrx {
    public void op1(int i, float f, boolean b, String s);
    public void op2(NumberAndString ns,
        String[] ss,
        java.util.Map st);
    public void op3(ClientToServerPrx proxy);
}
```

Given a proxy to a `ClientToServer` interface, the client code can pass parameters as in the following example:

```
ClientToServerPrx p = ...; // Get proxy...

p.op1(42, 3.14f, true, "Hello world!"); // Pass simple literals

int i = 42;
float f = 3.14f;
```

```

boolean b = true;
String s = "Hello world!";
p.op1(i, f, b, s); // Pass simple variables

NumberAndString ns = new NumberAndString();
ns.x = 42;
ns.str = "The Answer";
String[] ss = { "Hello world!" };
java.util.HashMap st = new java.util.HashMap();
st.put(new Long(0), ns);
p.op2(ns, ss, st); // Pass complex variables

p.op3(p); // Pass proxy

```

out-Parameters

Java does not have pass-by-reference: parameters are always passed by value. For a function to modify one of its arguments, we must pass a reference (by value) to an object; the called function can then modify the object's contents via the passed reference.

To permit the called function to modify a parameter, the Java mapping provides so-called *holder* classes. For example, for each of the built-in Slice types, such as `int` and `string`, the `Ice` package contains a corresponding holder class. Here are the definitions for the holder classes `Ice.IntHolder` and `Ice.StringHolder`:

```

package Ice;

public final class IntHolder {
    public IntHolder() {}
    public IntHolder(int value)
        this.value = value;
    }
    public int value;
}

public final class StringHolder {
    public StringHolder() {}
    public StringHolder(String value) {
        this.value = value;
    }
    public String value;
}

```

A holder class has a public `value` member that stores the value of the parameter; the called function can modify the value by assigning to that member. The class also has a default constructor and a constructor that accepts an initial value.

For user-defined types, such as structures, the Slice-to-Java compiler generates a corresponding holder type. For example, here is the generated holder type for the `NumberAndString` structure we defined on page 326:

```
public final class NumberAndStringHolder {
    public NumberAndStringHolder() {}

    public NumberAndStringHolder(NumberAndString value) {
        this.value = value;
    }

    public NumberAndString value;
}
```

This looks exactly like the holder classes for the built-in types: we get a default constructor, a constructor that accepts an initial value, and the public `value` member.

Note that holder classes are generated for *every* Slice type you define. For example, for sequences, such as the `FruitPlatter` sequence we saw on page 312, the compiler does not generate a special Java `FruitPlatter` type because sequences map to Java arrays. However, the compiler *does* generate a `FruitPlatterHolder` class, so we can pass a `FruitPlatter` array as an out-parameter.

To pass an out-parameter to an operation, we simply pass an instance of a holder class and examine the `value` member of each out-parameter when the call completes. Here is the same Slice definition we saw on page 326 once more, but this time with all parameters being passed in the out direction:

```
struct NumberAndString {
    int x;
    string str;
};

sequence<string> StringSeq;

dictionary<long, StringSeq> StringTable;

interface ServerToClient {
    void op1(out int i, out float f, out bool b, out string s);
    void op2(out NumberAndString ns,
```

```

        out StringSeq ss,
        out StringTable st);
    void op3(out ServerToClient* proxy);
};

```

The Slice compiler generates the following code for this definition:

```

public interface ClientToServerPrx extends Ice.ObjectPrx {
    public void op1(Ice.IntHolder i, Ice.FloatHolder f,
        Ice.BooleanHolder b, Ice.StringHolder s);
    public void op2(NumberAndStringHolder ns,
        StringSeqHolder ss, StringTableHolder st);
    public void op3(ClientToServerPrxHolder proxy);
}

```

Given a proxy to a `ServerToClient` interface, the client code can pass parameters as in the following example:

```

ClientToServerPrx p = ...;           // Get proxy...

Ice.IntHolder ih = new Ice.IntHolder();
Ice.FloatHolder fh = new Ice.FloatHolder();
Ice.BooleanHolder bh = new Ice.BooleanHolder();
Ice.StringHolder sh = new Ice.StringHolder();
p.op1(ih, fh, bh, sh);

NumberAndStringHolder nsh = new NumberAndString();
StringSeqHolder ssh = new StringSeqHolder();
StringTableHolder sth = new StringTableHolder();
p.op2(nsh, ssh, sth);

ServerToClientPrxHolder stcph = new ServerToClientPrxHolder();
p.op3(stcph);

System.out.println(ih.value); // Show one of the values

```

Again, there are no surprises in this code: the various holder instances contain values once the operation invocation completes and the `value` member of each instance provides access to those values.

Parameter Type Mismatches

Parameters in the Java mapping are statically type safe, with one exception: dictionaries map to `java.util.Map`, which is simply a mapping from `java.lang.Object` to `java.lang.Object`. It follows that, if you pass a

map between client and server, you must take care to ensure that the pairs of values you insert into the map are of the correct type. For example:

```
dictionary<string, long> AgeTable;
```

```
interface Ages {  
    void put(AgeTable ages);  
};
```

Given a proxy to an Ages object, the client code could look as follows:

```
AgesPrx ages = ...;    // Get proxy...  
  
java.util.HashMap ageTable = new java.util.HashMap();  
String name = "Michi Henning";  
Long age = new Long(42);  
ageTable.put(age, name);           // Oops...  
ages.put(ageTable);               // ClassCastException!
```

The problem here is that the order of the parameters for `ageTable.put` is reversed. When the proxy implementation tries to marshal the data, it notices the type mismatch and throws a `ClassCastException`.

Null Parameters

Some Slice types naturally have “empty” or “not there” semantics. Specifically, proxies, sequences, dictionaries, and strings all can be null:

- For proxies, a Java null reference denotes the null proxy. The null proxy is a dedicated value that indicates that a proxy points “nowhere” (denotes no object).
- Sequences and dictionaries cannot be null, but can be empty. To make life with these types easier, whenever you pass a Java null reference as a parameter or return value of type sequence or dictionary, the Ice run time automatically sends an empty sequence or dictionary to the receiver.
- Java strings can be null, but Slice strings cannot (because Slice strings do not support the concept of a null string). Whenever you pass a Java null string as a parameter or return value, the Ice run time automatically sends an empty string to the receiver.

This behavior is useful as a convenience feature: especially for deeply-nested data types, members that are sequences, dictionaries, or strings automatically arrive as an empty value at the receiving end. This saves you having to explicitly initialize, for example, every string element in a large sequence before sending it in order to

avoid `NullPointerException`s. Note that using null parameters in this way does *not* create null semantics for sequences, dictionaries, or strings. As far as the object model is concerned, these do not exist (only *empty* sequences, dictionaries, and strings do). For example if you send a string as a null reference or an empty string makes no difference to the receiver: either way, the receiver sees an empty string.

10.13 Exception Handling

Any operation invocation may throw a run-time exception (see Section 10.10 on page 315) and, if the operation has an exception specification, may also throw user exceptions (see Section 10.9 on page 314). Suppose we have the following simple interface:

```
exception Tantrum {
    string reason;
};

interface Child {
    void askToCleanUp() throws Tantrum;
};
```

Slice exceptions are thrown as Java exceptions, so you can simply enclose one or more operation invocations in a `try-catch` block:

```
ChildPrx child = ...;    // Get child proxy...

try {
    child.askToCleanUp();
} catch (Tantrum t) {
    System.out.write("The child says: ");
    System.out.println(t.reason);
}
```

Typically, you will catch only a few exceptions of specific interest around an operation invocation; other exceptions, such as unexpected run-time errors, will typically be handled by exception handlers higher in the hierarchy. For example:

```
public class Client {
    static void run() {
        ChildPrx child = ...;    // Get child proxy...
        try {
            child.askToCleanUp();
        }
    }
}
```

```

        } catch (Tantrum t) {
            System.out.print("The child says: ");
            System.out.println(t.reason);
            child.scold();           // Recover from error...
        }
        child.praise();           // Give positive feedback...
    }

    public static void
    main(String[] args)
    {
        try {
            // ...
            run();
            // ...
        } catch (Ice.LocalException e) {
            e.printStackTrace();
        } catch (Ice.UserException e) {
            System.err.println(e.getMessage());
        }
    }
}

```

This code handles a specific exception of local interest at the point of call and deals with other exceptions generically. (This is also the strategy we used for our first simple application in Chapter 3.)

Exceptions and out-Parameters

The Ice run time makes no guarantees about the state of out-parameters when an operation throws an exception: the parameter may still have its original value or may have been changed by the operation's implementation in the target object. In other words, for out-parameters, Ice provides the weak exception guarantee [21] but does not provide the strong exception guarantee.²

2. This is done for reasons of efficiency: providing the strong exception guarantee would require more overhead than can be justified.

10.14 Mapping for Classes

Slice classes are mapped to Java classes with the same name. The generated class contains a public data member for each Slice data member (just as for structures and exceptions), and a member function for each operation. Consider the following class definition:

```
class TimeOfDay {
    short hour;           // 0 - 23
    short minute;        // 0 - 59
    short second;        // 0 -59
    string format();     // Return time as hh:mm:ss
};
```

The Slice compiler generates the following code for this definition:

```
public interface _TimeOfDayOperations {
    String format(Ice.Current current);
}

public interface _TimeOfDayOperationsNC {
    String format();
}

public abstract class TimeOfDay extends Ice.ObjectImpl
    implements _TimeOfDayOperations,
               _TimeOfDayOperationsNC
{
    public short hour;
    public short minute;
    public short second;

    public TimeOfDay();
    public TimeOfDay(short hour, short minute, short second);
    // ...
}
```

There are a number of things to note about the generated code:

1. The compiler generates “operations interfaces” called `_TimeOfDayOperations` and `_TimeOfDayOperationsNC`. These interfaces contain a method for each Slice operation of the class.
2. The generated class `TimeOfDay` inherits (indirectly) from `Ice.Object`. This means that all classes implicitly inherit from `Ice.Object`, which is the ultimate ancestor of all classes. Note that `Ice.Object` is *not* the same as

`Ice.ObjectPrx`. In other words, you *cannot* pass a class where a proxy is expected and vice versa.

If a class has only data members, but no operations, the compiler generates a non-abstract class.

3. The generated class contains a public member for each Slice data member.
4. The generated class inherits member functions for each Slice operation from the operations interfaces.
5. The generated class contains two constructors.

There is quite a bit to discuss here, so we will look at each item in turn.

10.14.1 Operations Interfaces

The methods in the `_<interface-name>Operations` interface have an additional trailing parameter of type `Ice.Current`, whereas the methods in the `_<interface-name>OperationsNC` interface lack this additional trailing parameter. The methods without the `Current` parameter simply forward to the methods with a `Current` parameter, supplying a default `Current`. For now, you can ignore this parameter and pretend it does not exist. (We look at it in more detail in Section 31.6.)

If a class has only data members, but no operations, the compiler omits generating the `_<interface-name>Operations` and `_<interface-name>OperationsNC` interfaces.

10.14.2 Inheritance from `Ice.Object`

Like interfaces, classes implicitly inherit from a common base class, `Ice.Object`. However, as shown in Figure 10.1, classes inherit from `Ice.Object` instead of `Ice.ObjectPrx` (which is at the base of the inheritance hierarchy for proxies). As a result, you cannot pass a class where a proxy is

expected (and vice versa) because the base types for classes and proxies are not compatible.

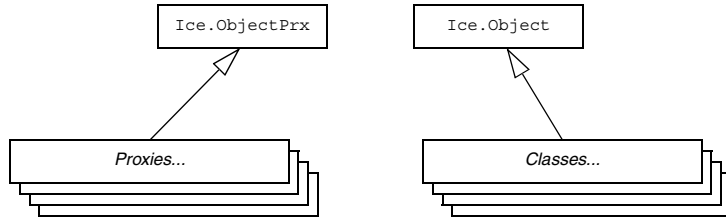

Figure 10.1. Inheritance from `Ice.ObjectPrx` and `Ice.Object`.

`Ice.Object` contains a number of member functions:

```
package Ice;

public interface Object
{
    int ice_getHash();

    boolean ice_isA(String s);
    boolean ice_isA(String s, Current current);

    void ice_ping();
    void ice_ping(Current current);

    String[] ice_ids();
    String[] ice_ids(Current current);

    String ice_id();
    String ice_id(Current current);

    void ice_preMarshal();
    void ice_postUnmarshal();
}
```

The member functions of `Ice.Object` behave as follows:

- `ice_getHash`

This function returns a hash value for the class, allowing you to easily place classes into hash tables. The implementation returns the value of `hashCode`.

- `ice_isA`
This function returns `true` if the object supports the given type ID, and `false` otherwise.
- `ice_ping`
As for interfaces, `ice_ping` provides a basic reachability test for the class.
- `ice_ids`
This function returns a string sequence representing all of the type IDs supported by this object, including `::Ice::Object`.
- `ice_id`
This function returns the actual run-time type ID for a class. If you call `ice_id` through a reference to a base instance, the returned type id is the actual (possibly more derived) type ID of the instance.
- `ice_preMarshal`
The Ice run time invokes this function prior to marshaling the object's state, providing the opportunity for a subclass to validate its declared data members.
- `ice_postUnmarshal`
The Ice run time invokes this function after unmarshaling an object's state. A subclass typically overrides this function when it needs to perform additional initialization using the values of its declared data members.

10.14.3 Data Members of Classes

Data members of classes are mapped exactly as for structures and exceptions: for each data member in the Slice definition, the generated class contains a corresponding public data member. Refer to Section 10.15.4 for additional information on data members.

10.14.4 Operations of Classes

Operations of classes are mapped to abstract member functions in the generated class. This means that, if a class contains operations (such as the `format` operation of our `TimeOfDay` class), you must provide an implementation of the operation in a class that is derived from the generated class. For example:

```

public class TimeOfDayI extends TimeOfDay {
    public String format(Ice.Current current) {
        DecimalFormat df
            = (DecimalFormat)DecimalFormat.getInstance();
        df.setMinimumIntegerDigits(2);
        return new String(df.format(hour) + ":" +
            df.format(minute) + ":" +
            df.format(second));
    }
}

```

Class Factories

Having created a class such as `TimeOfDayI`, we have an implementation and we can instantiate the `TimeOfDayI` class, but we cannot receive it as the return value or as an out-parameter from an operation invocation. To see why, consider the following simple interface:

```

interface Time {
    TimeOfDay get();
};

```

When a client invokes the `get` operation, the Ice run time must instantiate and return an instance of the `TimeOfDay` class. However, `TimeOfDay` is an abstract class that cannot be instantiated. Unless we tell it, the Ice run time cannot magically know that we have created a `TimeOfDayI` class that implements the abstract `format` operation of the `TimeOfDay` abstract class. In other words, we must provide the Ice run time with a factory that knows that the `TimeOfDay` abstract class has a `TimeOfDayI` concrete implementation. The `Ice::Communicator` interface provides us with the necessary operations:

```

module Ice {
    local interface ObjectFactory {
        Object create(string type);
        void destroy();
    };

    local interface Communicator {
        void addObjectFactory(ObjectFactory factory, string id);
        ObjectFactory findObjectFactory(string id);
        // ...
    };
};

```

To supply the Ice run time with a factory for our `TimeOfDayI` class, we must implement the `ObjectFactory` interface:

```
class ObjectFactory
    extends Ice.LocalObjectImpl
    implements Ice.ObjectFactory {
public Ice.Object create(String type) {
    if (type.equals("::M::TimeOfDay")) {
        return new TimeOfDayI();
    }
    assert(false);
    return null;
}

public void destroy() {
    // Nothing to do
}
}
```

The object factory's `create` method is called by the Ice run time when it needs to instantiate a `TimeOfDay` class. The factory's `destroy` method is called by the Ice run time when its communicator is destroyed.

The `create` method is passed the type ID (see Section 4.13) of the class to instantiate. For our `TimeOfDay` class, the type ID is `::M::TimeOfDay`. Our implementation of `create` checks the type ID: if it is `::M::TimeOfDay`, it instantiates and returns a `TimeOfDayI` object. For other type IDs, it asserts because it does not know how to instantiate other types of objects.

Given a factory implementation, such as our `ObjectFactory`, we must inform the Ice run time of the existence of the factory:

```
Ice.Communicator ic = ...;
ic.addObjectFactory(new ObjectFactory(), "::M::TimeOfDay");
```

Now, whenever the Ice run time needs to instantiate a class with the type ID `::M::TimeOfDay`, it calls the `create` method of the registered `ObjectFactory` instance.

The `destroy` operation of the object factory is invoked by the Ice run time when the communicator is destroyed. This gives you a chance to clean up any resources that may be used by your factory. Do not call `destroy` on the factory while it is registered with the communicator—if you do, the Ice run time has no idea that this has happened and, depending on what your `destroy` implementation is doing, may cause undefined behavior when the Ice run time tries to next use the factory.

The run time guarantees that `destroy` will be the last call made on the factory, that is, `create` will not be called concurrently with `destroy`, and `create` will not be called once `destroy` has been called. However, calls to `create` can be made concurrently.

Note that you cannot register a factory for the same type ID twice: if you call `addObjectFactory` with a type ID for which a factory is registered, the Ice run time throws an `AlreadyRegisteredException`.

Finally, keep in mind that if a class has only data members, but no operations, you need not create and register an object factory to transmit instances of such a class. Only if a class has operations do you have to define and register an object factory.

Inheritance from `LocalObject`

Note that the implementation of the factory in the previous example extends `Ice.LocalObjectImpl`. The object factory, being a local object, inherits a number of operations from `Ice.LocalObject`, such as `ice_getHash` (see page 319). The `Ice.LocalObjectImpl` class provides implementations for these operations, so you do not need to implement them yourself.

In general, all local interfaces inherit from `Ice.LocalObject`, and all implementations of local interfaces, such as an object factory or servant locator (see Section 31.7) must inherit from `Ice.LocalObjectImpl`.

10.14.5 Class Constructors

The generated class contains both a default constructor, and a constructor that accepts one argument for each member of the class. This allows you to create and initialize a class in a single statement, for example:

```
TimeOfDayI tod = new TimeOfDayI(14, 45, 00); // 14:45pm
```

For derived classes, the constructor requires one argument of all of the members of the class, including members of the base class(es). For example, consider the the definition from Section 4.11.2 once more:

```
class TimeOfDay {
    short hour;           // 0 - 23
    short minute;        // 0 - 59
    short second;        // 0 - 59
};

class DateTime extends TimeOfDay {
```

```

        short day;           // 1 - 31
        short month;        // 1 - 12
        short year;         // 1753 onwards
};

```

The constructors for the generated classes are as follows:

```

public class TimeOfDay extends Ice.ObjectImpl {
    public TimeOfDay() {}

    public TimeOfDay(short hour, short minute, short second)
    {
        this.hour = hour;
        this.minute = minute;
        this.second = second;
    }

    // ...
}

public class DateTime extends TimeOfDay
{
    public DateTime()
    {
        super();
    }

    public DateTime(short hour, short minute, short second,
                    short day, short month, short year)
    {
        super(hour, minute, second);
        this.day = day;
        this.month = month;
        this.year = year;
    }

    // ...
}

```

In other words, if you want to instantiate and initialize a `DateTime` instance, you must either use the default constructor or provide data for all of the data members of the instance, including data members of any base classes.

10.15 Customizing the Java Mapping

You can customize the code that the Slice-to-Java compiler produces by annotating your Slice definitions with metadata (see Section 4.17). This section describes how metadata influences several aspects of the generated Java code.

10.15.1 Packages

By default, the scope of a Slice definition determines the package of its mapped Java construct. A Slice type defined in a module hierarchy is mapped to a type residing in the equivalent Java package (see Section 10.4 for more information on the module mapping).

There are times when applications require greater control over the packaging of generated Java classes. For instance, a company may have software development guidelines that require all Java classes to reside in a designated package. One way to satisfy this requirement is to modify the Slice module hierarchy so that the generated code uses the required package by default. In the example below, we have enclosed the original definition of `Workflow::Document` in the modules `com::acme` so that the compiler will create the class in the `com.acme` package:

```
module com {
    module acme {
        module Workflow {
            class Document {
                // ...
            };
        };
    };
};
```

There are two problems with this workaround:

1. It incorporates the requirements of an implementation language into the application's interface specification.
2. Developers using other languages, such as C++, are also affected.

The Slice-to-Java compiler provides a better way to control the packages of generated code through the use of global metadata (see Section 4.17). The example above can be converted as follows:

```

[["java:package:com.acme"]]
module Workflow {
    class Document {
        // ...
    };
};

```

The global metadata directive `java:package:com.acme` instructs the compiler to generate all of the classes resulting from definitions in this Slice file into the Java package `com.acme`. The net effect is the same: the class for `Document` is generated in the package `com.acme.Workflow`. However, we have addressed the two shortcomings of the first solution by reducing our impact on the interface specification: the Slice-to-Java compiler recognizes the package metadata directive and modifies its actions accordingly, whereas the compilers for other language mappings simply ignore it.

Package Configuration Properties

Using global metadata to alter the default package of generated classes has ramifications for the Ice run time when unmarshaling exceptions and concrete class types. The Ice run time dynamically loads generated classes by translating their Slice type ids into Java class names. For example, the Ice run time translates the Slice type id `::Workflow::Document` into the class name `Workflow.Document`.

However, when the generated classes are placed in a user-specified package, the Ice run time can no longer rely on the direct translation of a Slice type id into a Java class name, and therefore must be configured in order to successfully locate the generated classes. Two configuration properties are supported:

- `Ice.Package.Module=package`
Associates a top-level³ Slice module with the package in which it was generated.
- `Ice.Default.Package=package`
Specifies a default package to use if other attempts to load a class have failed.

The behavior of the Ice run time when unmarshaling an exception or concrete class is described below:

3. Only top-level module names are allowed; the semantics of global metadata prevent a nested module from being generated into a different package than its enclosing module.

1. Translate the Slice type id into a Java class name and attempt to load the class.
2. If that fails, extract the top-level module from the type id and check for an `Ice.Package` property with a matching module name. If found, prepend the specified package to the class name and try to load the class again.
3. If that fails, check for the presence of `Ice.Default.Package`. If found, prepend the specified package to the class name and try to load the class again.
4. If the class still cannot be loaded, the instance may be sliced according to the rules described in Section 34.2.11.

Continuing our example from the previous section, we can define the following property:

```
Ice.Package.Workflow=com.acme
```

Alternatively, we could achieve the same result with this property:

```
Ice.Default.Package=com.acme
```

10.15.2 Java5 Mapping

The language features introduced in Java5 offer a number of convenient new capabilities that you can incorporate into your Ice applications. To enable support for Java5, you must annotate your Slice definitions with global metadata, and you must use a Java5-specific distribution of Ice for Java.

Metadata

The global metadata `java:java5` activates the Slice-to-Java compiler's support for the Java5 mapping. The effects of this metadata are described in the sections below. If you would prefer not to modify each of your Slice files to include the metadata, you can use the compiler's `--meta` option instead, as shown below:

```
$ slice2java --meta java:java5 Document.ice
```

The Java5 mapping cannot be used selectively. The metadata may only appear as global metadata, and has no effect when specified on individual Slice definitions. Furthermore, since the Java5 mapping alters the default mapping of several Slice types, you must use it for all of your Slice definitions. Using the `--meta` option as shown above is equivalent to defining the global metadata in `Document.ice` and in any files included directly or indirectly by `Document.ice`.

Regardless of whether you use the Java5 mapping, you may still customize the mapping of Slice sequence and dictionary types as described in Section 10.15.3.

Mapping for Enum

A Slice enum type maps to the Java5 enum type. Consider the example from Section 10.7.1:

```
enum Fruit { Apple, Pear, Orange };
```

The Java5 mapping for Fruit is shown below:

```
public enum Fruit {
    Apple(0),
    Pear(1),
    Orange(2);

    public static final int _Apple = 0;
    public static final int _Pear = 1;
    public static final int _Orange = 2;

    public int
    value() {
        // ...
    }

    public static Fruit
    convert(int val) {
        // ...
    }

    public static Fruit
    convert(String val) {
        // ...
    }

    // ...
}
```

As you can see, the Java5 mapping is very similar to the default mapping. The static members such as `_Apple` that supply the integer values of each enumerator are retained for backward compatibility.

Mapping for Dictionary

As explained in Section 10.7.4, the mapping for a Slice dictionary type defines both abstract and concrete types. In the Java5 mapping for a dictionary, the abstract and concrete types are instances of the generic types `java.util.Map<K, V>` and `java.util.HashMap<K, V>`, respectively,

where *K* is the Java5 mapping of the key type and *V* is the Java5 mapping of the value type.

Consider our earlier dictionary example:

```
dictionary<long, Employee> EmployeeMap;
```

The typesafe nature of the Java5 mapping makes using dictionaries simpler, since it eliminates the need for casts and wrapper objects:

```
java.util.Map<Long, Employee> em =  
    new java.util.HashMap<Long, Employee>();
```

```
Employee e = new Employee();  
e.number = 31;  
e.firstName = "James";  
e.lastName = "Gosling";
```

```
em.put(e.number, e);
```

Iterating over the dictionary is also more convenient in the Java5 mapping:

```
for(java.util.Map.Entry<Long, Employee> i : em.entrySet())  
{  
    long num = i.getKey();  
    Employee emp = i.getValue();  
    System.out.println(emp.firstName + " was employee #" + num);  
}
```

Mapping for Sequence

The default mapping for a Slice sequence type remains unchanged for Java5 and continues to use a native Java array, which is the most efficient representation. If you specify a custom type for a sequence (see Section 10.15.3) and do not also specify the abstract type, the Java5 mapping uses the abstract type `java.util.List<E>` by default, where *E* is the Java5 mapping of the element type.

10.15.3 Custom Types

One of the more powerful applications of metadata is the ability to tailor the Java mapping for sequence and dictionary types to match the needs of your application.

Metadata

The metadata for specifying a custom type has the following format:

```
java:type:concrete-type[:abstract-type]
```

The abstract type is optional; the compiler uses a default value if one is not defined. The concrete type must satisfy an *is-A* relationship with the abstract type: either the same class is specified for both types, or the concrete type must be derived from the abstract type.

The Slice-to-Java compiler generates code that uses the abstract type for all occurrences of the modified Slice definition except when the generated code must instantiate the type, in which case the compiler uses the concrete type instead.

The compiler performs no validation on your custom types. Misspellings and other errors will not be apparent until you compile the generated code.

Defining a Custom Sequence Type

Although the default mapping of a sequence type to a native Java array is efficient and typesafe, it is not always the most convenient representation of your data. To use a different representation, specify the type information in a metadata directive, as shown in the following example:

```
["java:type:java.util.LinkedList"]  
sequence<string> StringList;
```

If you prefer a typesafe class, you can use a Java5 generic type instead:

```
["java:type:java.util.LinkedList<String>"]  
sequence<string> StringList;
```

It is your responsibility to use a type parameter for the Java5 class (`String` in the example above) that is the correct mapping for the sequence's element type.

The compiler selects a default abstract type if you do not define one. If the Java5 mapping is enabled (see Section 10.15.2), the default abstract type is `java.util.List<E>`, where `E` is the Java5 mapping of the element type. Otherwise, the default abstract type is `java.util.List`.

It is legal to use Java5 classes in your metadata even if the Java5 mapping is not enabled. In this situation, we recommend that you always specify an appropriate abstract type explicitly because the compiler's default type, `java.util.List`, may cause the Java compiler to emit warnings when you compile the generated code. The example below demonstrates the use of an abstract type:

```
["java:type:java.util.LinkedList<String>:java.util.List<String>"]
sequence<string> StringList;
```

Defining a Custom Dictionary Type

If the semantics of a `HashMap` are not suitable for your application, you can specify an alternate type using metadata as shown in the example below:

```
["java:type:java.util.TreeMap"]
dictionary<string, string> StringMap;
```

If you prefer a typesafe class, you can use a Java5 generic type instead:

```
["java:type:java.util.TreeMap<String, String>"]
dictionary<string, string> StringMap;
```

It is your responsibility to use type parameters for the Java5 class (`String` in the example above) that are the correct mappings for the dictionary's key and value types.

The compiler selects a default abstract type if you do not define one. If the Java5 mapping is enabled (see Section 10.15.2), the default abstract type is `java.util.Map<K, V>`, where `K` is the Java5 mapping of the key type and `V` is the Java5 mapping of the value type. Otherwise, the default abstract type is `java.util.Map`.

It is legal to use Java5 classes in your metadata even if the Java5 mapping is not enabled. In this situation, we recommend that you always specify an appropriate abstract type explicitly because the compiler's default type, `java.util.Map`, may cause the Java compiler to emit warnings when you compile the generated code. The example below demonstrates the use of an abstract type:

```
["java:type:java.util.TreeMap<String, String>:java.util.Map<String, String>"]
dictionary<string, string> StringMap;
```

Usage

You can define custom type metadata in a variety of situations. The simplest scenario is specifying the metadata at the point of definition:

```
["java:type:java.util.LinkedList"]
sequence<string> StringList;
```

Defined in this manner, the Slice-to-Java compiler uses `java.util.List` (the default abstract type) for all occurrences of `StringList`, and `java.util.LinkedList` when it needs to instantiate `StringList`.

You may also specify a custom type more selectively by defining metadata for a data member, parameter or return value. For instance, the mapping for the original Slice definition might be sufficient in most situations, but a different mapping is more convenient in particular cases. The example below demonstrates how to override the sequence mapping for the data member of a structure as well as for several operations:

```
sequence<string> StringSeq;

struct S {
    ["java:type:java.util.LinkedList"] StringSeq seq;
};

interface I {
    ["java:type:java.util.ArrayList"] StringSeq
    modifiedReturnValue();

    void modifiedInParam(
        ["java:type:java.util.ArrayList"] StringSeq seq);

    void modifiedOutParam(
        out ["java:type:java.util.ArrayList"] StringSeq seq);
};
```

As you might expect, modifying the mapping for an operation's parameters or return value may require the application to manually convert values from the original mapping to the modified mapping. For example, suppose we want to invoke the `modifiedInParam` operation. The signature of its proxy operation is shown below:

```
void modifiedInParam(java.util.List seq, Ice.Current curr)
```

The metadata changes the mapping of the `seq` parameter to `java.util.List`, which is the default abstract type. If a caller has a `StringSeq` value in the original mapping, it must convert the array as shown in the following example:

```
String[] seq = new String[2];
seq[0] = "hi";
seq[1] = "there";
IPrx proxy = ...;
proxy.modifiedInParam(java.util.Arrays.asList(seq));
```

Although we specified the concrete type `java.util.ArrayList` for the parameter, we are still able to pass the result of `asList` because its return type (`java.util.List`) is compatible with the parameter's abstract type declared by the proxy method. In the case of an operation parameter, the concrete type is only relevant to a servant implementation, which may need to make assumptions about the actual type of the parameter.

Mapping for Modified Out Parameters

The mapping for an out parameter uses a generated “holder” class to convey the parameter value (see Section 10.12.2). If you modify the mapping of an out parameter, as discussed in the previous section, it is possible that the holder class for the parameter's unmodified type is no longer compatible with the custom type you have specified. The holder class generated for `StringSeq` is shown below:

```
public final class StringSeqHolder
{
    public
    StringSeqHolder()
    {
    }

    public
    StringSeqHolder(String[] value)
    {
        this.value = value;
    }

    public String[] value;
}
```

An out parameter of type `StringSeq` would normally map to a proxy method that used `StringSeqHolder` to hold the parameter value. When the parameter is modified, as is the case with the `modifiedOutParam` operation, the Slice-to-Java compiler cannot use `StringSeqHolder` to hold an instance of `java.util.List`, because `StringSeqHolder` is only appropriate for the default mapping to a native array.

As a result, the compiler uses special holder classes in these situations. For the example above, the compiler generates the following proxy method:

```
void modifiedOutParam(ice.ListHolder seq, ice.Current curr)
```

The `ice.ListHolder` class holds an instance of `java.util.List`. The compiler uses `ListHolder` for all modified out sequence parameters whose

abstract type is `java.util.List`. As a convenience, the compiler uses the class `Ice.ArrayListHolder` for an abstract type of `java.util.ArrayList`, and `Ice.LinkedListHolder` for an abstract type of `java.util.LinkedList`.

In a similar fashion, the compiler uses `Ice.MapHolder` when it detects an incompatibility for a modified out dictionary parameter. `Ice.MapHolder` holds a value of type `java.util.Map`.

In the Java5 mapping, the compiler handles these situations using instances of the generic class `Ice.Holder<T>`, where `T` is the parameter's abstract type. Consider the following example:

```
sequence<string> StringSeq;

interface I {
    void modifiedOutParam(
        out ["java:type:java.util.ArrayList<String>"]
        StringSeq seq);
};
```

The compiler generates the following Java5 mapping for the `modifiedOutParam` proxy method:

```
void modifiedOutParam(
    Ice.Holder<java.util.List<java.lang.String> > seq,
    Ice.Current curr)
```

The abstract type of the parameter is `java.util.List<String>`, therefore the holder class becomes `Ice.Holder<java.util.List<String>>`.

10.15.4 **JavaBean Mapping**

The Java mapping optionally generates JavaBean-style methods for the data members of class, struct and exception types.

Generated Methods

For each data member `val` of type `T`, the mapping generates the following methods:

```
public T getVal();
public void setVal(T v);
```

The mapping generates an additional method if `T` is the `bool` type:

```
public boolean isVal();
```

Finally, if T is a sequence type with an element type E , two methods are generated to provide direct access to elements:

```
public E getVal(int index);
public void setVal(int index, E v);
```

Note that these element methods are only generated for sequence types that use the default mapping.

The Slice-to-Java compiler considers it a fatal error for a JavaBean method of a class data member to conflict with a declared operation of the class. In this situation, you must rename the operation or the data member, or disable the generation of JavaBean methods for the data member in question.

Metadata

The JavaBean methods are generated for a data member when the member or its enclosing type is annotated with the `java:getset` metadata. The following example demonstrates both styles of usage:

```
sequence<int> IntSeq;

class C {
    ["java:getset"] int i;
    double d;
};

["java:getset"]
struct S {
    bool b;
    string str;
};

["java:getset"]
exception E {
    IntSeq seq;
};
```

JavaBean methods are generated for all members of struct `S` and exception `E`, but for only one member of class `C`. Relevant portions of the generated code are shown below:

```
public class C extends Ice.ObjectImpl
{
    ...

    public int i;
```

```
public int
getI()
{
    return i;
}

public void
setI(int _i)
{
    i = _i;
}

public double d;
}

public final class S implements java.lang.Cloneable
{
    public boolean b;

    public boolean
    getB()
    {
        return b;
    }

    public void
    setB(boolean _b)
    {
        b = _b;
    }

    public boolean
    isB()
    {
        return b;
    }

    public String str;

    public String
    getStr()
    {
        return str;
    }
}
```

```
    public void
    setStr(String _str)
    {
        str = _str;
    }

    ...
}

public class E extends Ice.UserException
{
    ...

    public int[] seq;

    public int[]
    getSeq()
    {
        return seq;
    }

    public void
    setSeq(int[] _seq)
    {
        seq = _seq;
    }

    public int
    getSeq(int _index)
    {
        return seq[_index];
    }

    public void
    setSeq(int _index, int _val)
    {
        seq[_index] = _val;
    }

    ...
}
```

10.16 `slice2java` Command-Line Options

The Slice-to-Java compiler, `slice2java`, offers the following command-line options in addition to the standard options described in Section 4.19:

- `--tie`
Generate tie classes (see Section 12.7).
- `--impl`
Generate sample implementation files. This option will not overwrite an existing file.
- `--impl-tie`
Generate sample implementation files using ties (see Section 12.7). This option will not overwrite an existing file.
- `--checksum CLASS`
Generate checksums for Slice definitions into the class *CLASS*. The given class name may optionally contain a package specifier. The generated class contains checksums for all of the Slice files being translated by this invocation of the compiler. For example, the command below causes `slice2java` to generate the file `Checksums.java` containing the checksums for the Slice definitions in `File1.ice` and `File2.ice`:

```
slice2java --checksum Checksums File1.ice File2.ice
```
- `--stream`
Generate streaming helper functions for Slice types (see Section 36.2).
- `--meta META`
Define the global metadata directive *META*. Using this option is equivalent to defining the global metadata *META* in each named Slice file, as well as in any file included by a named Slice file. See Section 10.15.2 for an example of using this option.

10.17 Using Slice Checksums

As described in Section 4.20, the Slice compilers can optionally generate checksums of Slice definitions. For `slice2java`, the `--checksum` option causes the compiler to generate a new Java class that adds checksums to a static map

member. Assuming we supplied the option `--checksum Checksums` to `slice2java`, the generated class `Checksums.java` looks like this:

```
public class Checksums {
    public static java.util.Map checksums;
}
```

The read-only map `checksums` is initialized automatically prior to first use; no action is required by the application.

In order to verify a server's checksums, a client could simply compare the dictionaries using the `equals` method. However, this is not feasible if it is possible that the server might return a superset of the client's checksums. A more general solution is to iterate over the local checksums as demonstrated below:

```
java.util.Map serverChecksums = ...
java.util.Iterator i = Checksums.checksums.entrySet().iterator();
while(i.hasNext()) {
    java.util.Map.Entry e = (java.util.Map.Entry)i.next();
    String id = (String)e.getKey();
    String checksum = (String)e.getValue();
    String serverChecksum = (String)serverChecksums.get(id);
    if(serverChecksum == null) {
        // No match found for type id!
    } else if(!checksum.equals(serverChecksum)) {
        // Checksum mismatch!
    }
}
```

In this example, the client first verifies that the server's dictionary contains an entry for each `Slice` type ID, and then it proceeds to compare the checksums.

Chapter 11

Developing a File System Client in Java

11.1 Chapter Overview

In this chapter, we present the source code for a Java client that accesses the file system we developed in Chapter 5 (see Chapter 13 for the corresponding server).

11.2 The Java Client

We now have seen enough of the client-side Java mapping to develop a complete client to access our remote file system. For reference, here is the Slice definition once more:

```
module Filesystem {
    interface Node {
        nonmutating string name();
    };

    exception GenericError {
        string reason;
    };

    sequence<string> Lines;

    interface File extends Node {
```

```

        nonmutating Lines read();
        idempotent void write(Lines text) throws GenericError;
};

sequence<Node*> NodeSeq;

interface Directory extends Node {
    nonmutating NodeSeq list();
};

interface Filesys {
    nonmutating Directory* getRoot();
};
};

```

To exercise the file system, the client does a recursive listing of the file system, starting at the root directory. For each node in the file system, the client shows the name of the node and whether that node is a file or directory. If the node is a file, the client retrieves the contents of the file and prints them.

The body of the client code looks as follows:

```

import Filesystem.*;

public class Client {

    // Recursively print the contents of directory "dir" in
    // tree fashion. For files, show the contents of each file.
    // The "depth" parameter is the current nesting level
    // (for indentation).

    static void
    listRecursive(DirectoryPrx dir, int depth)
    {
        char[] indentCh = new char[++depth];
        java.util.Arrays.fill(indentCh, '\t');
        String indent = new String(indentCh);

        NodePrx[] contents = dir.list();

        for (int i = 0; i < contents.length; ++i) {
            DirectoryPrx subdir
                = DirectoryPrxHelper.checkedCast(contents[i]);
            FilePrx file
                = FilePrxHelper.uncheckedCast(contents[i]);
            System.out.println(indent + contents[i].name() +

```

```
        (subdir != null ? " (directory):" : " (file):"));
if (subdir != null) {
    listRecursive(subdir, depth);
} else {
    String[] text = file.read();
    for (int j = 0; j < text.length; ++j)
        System.out.println(indent + "\t" + text[j]);
}
}
}

public static void
main(String[] args)
{
    int status = 0;
    Ice.Communicator ic = null;
    try {
        // Create a communicator
        //
        ic = Ice.Util.initialize(args);

        // Create a proxy for the root directory
        //
        Ice.ObjectPrx base
            = ic.stringToProxy("RootDir:default -p 10000");
        if (base == null)
            throw new RuntimeException("Cannot create proxy");

        // Down-cast the proxy to a Directory proxy
        //
        DirectoryPrx rootDir
            = DirectoryPrxHelper.checkedCast(base);
        if (rootDir == null)
            throw new RuntimeException("Invalid proxy");

        // Recursively list the contents of the root directory
        //
        System.out.println("Contents of root directory:");
        listRecursive(rootDir, 0);
    } catch (Ice.LocalException e) {
        e.printStackTrace();
        status = 1;
    } catch (Exception e) {
        System.err.println(e.getMessage());
        status = 1;
    }
}
```

```
        if (ic != null) {
            // Clean up
            //
            try {
                ic.destroy();
            } catch (Exception e) {
                System.err.println(e.getMessage());
                status = 1;
            }
        }
        System.exit(status);
    }
}
```

After importing the `Filesystem` package, the `Client` class defines two methods: `listRecursive`, which is a helper function to print the contents of the file system, and `main`, which is the main program. Let us look at `main` first:

1. The structure of the code in `main` follows what we saw in Chapter 3. After initializing the run time, the client creates a proxy to the root directory of the file system. For this example, we assume that the server runs on the local host and listens using the default protocol (TCP/IP) at port 10000. The object identity of the root directory is known to be `RootDir`.
2. The client down-casts the proxy to `DirectoryPrx` and passes that proxy to `listRecursive`, which prints the contents of the file system.

Most of the work happens in `listRecursive`. The function is passed a proxy to a directory to list, and an indent level. (The indent level increments with each recursive call and allows the code to print the name of each node at an indent level that corresponds to the depth of the tree at that node.) `listRecursive` calls the `list` operation on the directory and iterates over the returned sequence of nodes:

1. The code does a `checkedCast` to narrow the `Node` proxy to a `Directory` proxy, as well as an `uncheckedCast` to narrow the `Node` proxy to a `File` proxy. Exactly one of those casts will succeed, so there is no need to call `checkedCast` twice: if the `Node` *is-a* `Directory`, the code uses the `DirectoryPrx` returned by the `checkedCast`; if the `checkedCast` fails, we *know* that the `Node` *is-a* `File` and, therefore, an `uncheckedCast` is sufficient to get a `FilePrx`.

In general, if you know that a down-cast to a specific type will succeed, it is preferable to use an `uncheckedCast` instead of a `checkedCast` because an `uncheckedCast` does not incur any network traffic.

2. The code prints the name of the file or directory and then, depending on which cast succeeded, prints " (directory) " or " (file) " following the name.
3. The code checks the type of the node:
 - If it is a directory, the code recurses, incrementing the indent level.
 - If it is a file, the code calls the read operation on the file to retrieve the file contents and then iterates over the returned sequence of lines, printing each line.

Assume that we have a small file system consisting of two files and a directory as follows:

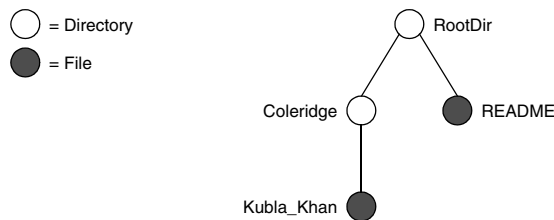

Figure 11.1. A small file system.

The output produced by client for this file system is:

```

Contents of root directory:
  README (file):
    This file system contains a collection of poetry.
  Coleridge (directory):
    Kubla_Khan (file):
      In Xanadu did Kubla Khan
      A stately pleasure-dome decree:
      Where Alph, the sacred river, ran
      Through caverns measureless to man
      Down to a sunless sea.
  
```

Note that, so far, our client (and server) are not very sophisticated:

- The protocol and address information are hard-wired into the code.
- The client makes more remote procedure calls than strictly necessary; with minor redesign of the Slice definitions, many of these calls can be avoided.

We will see how to address these shortcomings in Chapter 37 and XREF.

11.3 Summary

This chapter presented a very simple client to access a server that implements the file system we developed in Chapter 5. As you can see, the Java code hardly differs from the code you would write for an ordinary Java program. This is one of the biggest advantages of using Ice: accessing a remote object is as easy as accessing an ordinary, local Java object. This allows you to put your effort where you should, namely, into developing your application logic instead of having to struggle with arcane networking APIs. As we will see in Chapter 13, this is true for the server side as well, meaning that you can develop distributed applications easily and efficiently.

Chapter 12

Server-Side Slice-to-Java Mapping

12.1 Chapter Overview

In this chapter, we present the server-side Slice-to-Java mapping (see Chapter 10 for the client-side mapping). Section 12.3 discusses how to initialize and finalize the server-side run time, sections 12.4 to 12.7 show how to implement interfaces and operations, and Section 12.8 discusses how to register objects with the server-side Ice run time.

12.2 Introduction

The mapping for Slice data types to Java is identical on the client side and server side. This means that everything in Chapter 10 also applies to the server side. However, for the server side, there are a few additional things you need to know, specifically:

- how to initialize and finalize the server-side run time
- how to implement servants
- how to pass parameters and throw exceptions
- how to create servants and register them with the Ice run time.

We discuss these topics in the remainder of this chapter.

12.3 The Server-Side `main` Function

The main entry point to the Ice run time is represented by the local interface `Ice::Communicator`. As for the client side, you must initialize the Ice run time by calling `Ice.Util.initialize` before you can do anything else in your server. `Ice.Util.initialize` returns a reference to an instance of an `Ice.Communicator`:

```
public class Server {
    public static void
    main(String[] args)
    {
        int status = 0;
        Ice.Communicator ic = null;
        try {
            ic = Ice.Util.initialize(args);
            // ...
        } catch (Exception e) {
            e.printStackTrace();
            status = 1;
        }
        // ...
    }
}
```

`Ice.Util.initialize` accepts the argument vector that is passed to `main` by the operating system. The function scans the argument vector for any command-line options that are relevant to the Ice run time, but does not remove those options.¹ If anything goes wrong during initialization, `initialize` throws an exception.

Before leaving your `main` function, you *must* call `Communicator::destroy`. The `destroy` operation is responsible for finalizing the Ice run time. In particular, `destroy` waits for any operation invocations that may still be running to complete. In addition, `destroy` ensures that any outstanding threads are joined with and reclaims a number of operating system resources, such as file descriptors and memory. Never allow your `main` function to terminate without calling `destroy` first; doing so has undefined behavior.

1. The semantics of Java arrays prevents `Ice.Util.initialize` from modifying the size of the argument vector. However, another overloading of `Ice.Util.initialize` is provided that allows the application to obtain a new argument vector with the Ice options removed.

The general shape of our server-side main function is therefore as follows:

```
public class Server {
    public static void
    main(String[] args)
    {
        int status = 0;
        Ice.Communicator ic = null;
        try {
            ic = Ice.Util.initialize(args);
            // ...
        } catch (Exception e) {
            e.printStackTrace();
            status = 1;
        }
        if (ic != null) {
            try {
                ic.destroy();
            } catch (Exception e) {
                e.printStackTrace();
                status = 1;
            }
        }
        System.exit(status);
    }
}
```

Note that the code places the call to `Ice::initialize` into a `try` block and takes care to return the correct exit status to the operating system. Also note that an attempt to destroy the communicator is made only if the initialization succeeded.

12.3.1 The `Ice.Application` Class

The preceding structure for the main function is so common that `Ice` offers a class, `Ice.Application`, that encapsulates all the correct initialization and finalization activities. The synopsis of the class is as follows (with some detail omitted for now):

```
package Ice;

public abstract class Application {
    public Application()

        public final int main(String appName, String[] args)
```

```

public final int
    main(String appName, String[] args, String configFile)

public abstract int run(String[] args);

public static String appName()

public static Communicator communicator()

    // ...
}

```

The intent of this class is that you specialize `Ice.Application` and implement the abstract `run` method in your derived class. Whatever code you would normally place in `main` goes into the `run` method instead. Using `Ice.Application`, our program looks as follows:

```

public class Server extends Ice.Application {
    public int
    run(String[] args)
    {
        // Server code here...

        return 0;
    }

    public static void
    main(String[] args)
    {
        Server app = new Server();
        int status = app.main("Server", args);
        System.exit(status);
    }
}

```

The `Application.main` function does the following:

1. It installs an exception handler for `java.lang.Exception`. If your code fails to handle an exception, `Application.main` prints the name of an exception and a stack trace on `System.err` before returning with a non-zero return value.
2. It initializes (by calling `Ice.Util.initialize`) and finalizes (by calling `Communicator.destroy`) a communicator. You can get access to the communicator for your server by calling the static `communicator` accessor.

3. It scans the argument vector for options that are relevant to the Ice run time and removes any such options. The argument vector that is passed to your `run` method therefore is free of Ice-related options and only contains options and arguments that are specific to your application.
4. It provides the name of your application via the static `appName` member function. The return value from this call is the first argument in the call to `Application.main`, so you can get at this name from anywhere in your code by calling `Ice.Application.appName` (which is usually required for error messages). In the example above, the return value from `appName` would be `Server`.
5. It installs a shutdown hook that properly shuts down the communicator.

Using `Ice.Application` ensures that your program properly finalizes the Ice run time, whether your server terminates normally or in response to an exception. We recommend that all your programs use this class; doing so makes your life easier. In addition `Ice.Application` also provides features for signal handling and configuration that you do not have to implement yourself when you use this class.

Using `Ice.Application` on the Client Side

You can use `Ice.Application` for your clients as well: simply implement a class that derives from `Ice.Application` and place the client code into its `run` method. The advantage of this approach is the same as for the server side: `Ice.Application` ensures that the communicator is destroyed correctly even in the presence of exceptions.

Catching Signals

The simple server we developed in Chapter 3 had no way to shut down cleanly: we simply interrupted the server from the command line to force it to exit. Terminating a server in this fashion is unacceptable for many real-life server applications: typically, the server has to perform some cleanup work before terminating, such as flushing database buffers or closing network connections. This is particularly important on receipt of a signal or keyboard interrupt to prevent possible corruption of database files or other persistent data.

Java does not provide direct support for signals, but it does allow an application to register a *shutdown hook* that is invoked when the JVM is shutting down. There are several events which trigger JVM shutdown, such as a call to

`System.exit` or an interrupt signal from the operating system, but the shutdown hook is not provided with the reason for the shut down.

`Ice.Application` registers a shutdown hook by default, allowing you to cleanly terminate your application prior to JVM shutdown:

```
package Ice;

public abstract class Application {
    // ...

    synchronized public static void destroyOnInterrupt()

    synchronized public static void shutdownOnInterrupt()

    synchronized public static void defaultInterrupt()

    synchronized public static boolean interrupted()
}
```

The member functions behave as follows:

- `destroyOnInterrupt`
This function installs a shutdown hook that calls `destroy` on the communicator. This is the default behavior.
- `shutdownOnInterrupt`
This function installs a shutdown hook that calls `shutdown` on the communicator.
- `defaultInterrupt`
This function removes the shutdown hook.
- `interrupted`
This function returns `true` if the shutdown hook caused the communicator to shut down, `false` otherwise. This allows us to distinguish intentional shutdown from a forced shutdown that was caused by the JVM. This is useful, for example, for logging purposes.

By default, `Ice.Application` behaves as if `destroyOnInterrupt` was invoked, therefore our server `main` function requires no change to ensure that the program terminates cleanly on JVM shutdown. However, we add a diagnostic to report the occurrence, so our `main` function now looks like:

```
public class Server extends Ice.Application {
    public int
    run(String[] args)
    {
        // Server code here...

        if (interrupted())
            System.err.println(appName() + ": terminating");

        return 0;
    }

    public static void
    main(String[] args)
    {
        Server app = new Server();
        int status = app.main("Server", args);
        System.exit(status);
    }
}
```

Ice.Application and Properties

Apart from the functionality shown in this section, `Ice.Application` also takes care of initializing the Ice run time with property values. Properties allow you to configure the run time in various ways. For example, you can use properties to control things such as the thread pool size or port number for a server. The `main` function of `Ice.Application` is overloaded; the second version allows you to specify the name of a configuration file that will be processed during initialization. We discuss Ice properties in more detail in Chapter 30.

Limitations of Ice.Application

`Ice.Application` is a singleton class that creates a single communicator. If you are using multiple communicators, you cannot use `Ice.Application`. Instead, you must structure your code as we saw in Chapter 3 (taking care to always destroy the communicator).

12.4 Mapping for Interfaces

The server-side mapping for interfaces provides an up-call API for the Ice run time: by implementing member functions in a servant class, you provide the hook

that gets the thread of control from the Ice server-side run time into your application code.

12.4.1 Skeleton Classes

On the client side, interfaces map to proxy classes (see Section 5.12). On the server side, interfaces map to *skeleton* classes. A skeleton is a class that has a pure virtual member function for each operation on the corresponding interface. For example, consider the Slice definition for the `Node` interface we defined in Chapter 5 once more:

```
module Filesystem {
    interface Node {
        nonmutating string name();
    };
    // ...
};
```

The Slice compiler generates the following definition for this interface:

```
package Filesystem;

public interface _NodeOperations
{
    String name(Ice.Current current);
}

public interface _NodeOperationsNC
{
    String name();
}

public interface Node extends Ice.Object,
                               _NodeOperations,
                               _NodeOperationsNC {}

public abstract class _NodeDisp extends Ice.ObjectImpl
                               implements Node
{
    // Mapping-internal code here...
}
```

The important points to note here are:

- As for the client side, Slice modules are mapped to Java packages with the same name, so the skeleton class definitions are part of the `Filesystem` package.
- For each Slice interface *<interface-name>*, the compiler generates Java interfaces `_<interface-name>Operations` and `_<interface-name>OperationsNC` (`_NodeOperations` and `_NodeOperationsNC` in this example). These interfaces contains a member function for each operation in the Slice interface. (You can ignore the `Ice.Current` parameter for the time being—we discuss it in detail in Section 31.6.)
- For each Slice interface *<interface-name>*, the compiler generates a Java interface *<interface-name>* (`Node` in this example). That interface extends `Ice.Object` and the two operations interfaces.
- For each Slice interface *<interface-name>*, the compiler generates an abstract class `_<interface-name>Disp` (`_NodeDisp` in this example). This abstract class is the actual skeleton class; it is the base class from which you derive your servant class.

12.4.2 Servant Classes

In order to provide an implementation for an Ice object, you must create a servant class that inherits from the corresponding skeleton class. For example, to create a servant for the `Node` interface, you could write:

```
package Filesystem;

public final class NodeI extends _NodeDisp {

    public NodeI(String name)
    {
        _name = name;
    }

    public String name(Ice.Current current)
    {
        return _name;
    }

    private String _name;
}
```

By convention, servant classes have the name of their interface with an `I`-suffix, so the servant class for the `Node` interface is called `NodeI`. (This is a convention only: as far as the Ice run time is concerned, you can choose any name you prefer for your servant classes.) Note that `NodeI` extends `_NodeDisp`, that is, it derives from its skeleton class.

As far as Ice is concerned, the `NodeI` class must implement only a single method: the name method that it inherits from its skeleton. This makes the servant class a concrete class that can be instantiated. You can add other member functions and data members as you see fit to support your implementation. For example, in the preceding definition, we added a `_name` member and a constructor. (Obviously, the constructor initializes the `_name` member and the name function returns its value.)

Normal, idempotent, and nonmutating Operations

Whether an operation is an ordinary operation, or an `idempotent` or `nonmutating` operation has no influence on the way the operation is mapped. To illustrate this, consider the following interface:

```
interface Example {
    void normalOp();
    idempotent void idempotentOp();
    nonmutating void nonmutatingOp();
};
```

The operations class for this interface looks like this:

```
public interface _ExampleOperations
{
    void normalOp(Ice.Current current);
    void idempotentOp(Ice.Current current);
    void nonmutatingOp(Ice.Current current);
}
```

Note that the signatures of the member functions are unaffected by the `idempotent` and `nonmutating` qualifiers. (In C++, the `nonmutating` qualifier generates a C++ `const` member function.)

12.5 Parameter Passing

For each parameter of a Slice operation, the Java mapping generates a corresponding parameter for the corresponding method in the

`_<interface-name>Operations` interface. In addition, every operation has an additional, trailing parameter of type `Ice.Current`. For example, the `name` operation of the `_Node` interface has no parameters, but the `name` member function of the `_NodeOperations` interface has a single parameter of type `Ice.Current`. We explain the purpose of this parameter in Section 31.6 and will ignore it for now.

To illustrate the rules, consider the following interface that passes string parameters in all possible directions:

```
module M {
    interface Example {
        string op(string sin, out string sout);
    };
};
```

The generated skeleton class for this interface looks as follows:

```
public interface _ExampleOperations
{
    String op(String sin, Ice.StringHolder sout,
              Ice.Current current);
}
```

As you can see, there are no surprises here. For example, we could implement `op` as follows:

```
public final class ExampleI extends M._ExampleDisp {
    public String op(String sin, Ice.StringHolder sout,
                    Ice.Current current)
    {
        System.out.println(sin);    // In params are initialized
        sout.value = "Hello World!"; // Assign out param
        return "Done";
    }
}
```

This code is in no way different from what you would normally write if you were to pass strings to and from a function; the fact that remote procedure calls are involved does not impact on your code in any way. The same is true for parameters of other types, such as proxies, classes, or dictionaries: the parameter passing conventions follow normal Java rules and do not require special-purpose API calls.

12.6 Raising Exceptions

To throw an exception from an operation implementation, you simply instantiate the exception, initialize it, and throw it. For example:

```
// ...

public void
write(String[] text, Ice.Current current)
    throws GenericError

{
    // Try to write file contents here...
    // Assume we are out of space...
    if (error) {
        GenericError e = new GenericError();
        e.reason = "file too large";
        throw e;
    }
}
```

If you throw an arbitrary Java run-time exception (such as a `ClassCastException`), the Ice run time catches the exception and then returns an `UnknownException` to the client. Similarly, if you throw an “impossible” user exception (a user exception that is not listed in the exception specification of the operation), the client receives an `UnknownUserException`.

If you throw an Ice run-time exception, such `MemoryLimitException`, the client receives an `UnknownLocalException`.² For that reason, you should never throw system exceptions from operation implementations. If you do, all the client will see is an `UnknownLocalException`, which does not tell the client anything useful.

12.7 Tie Classes

The mapping to skeleton classes we saw in Section 12.4 requires the servant class to inherit from its skeleton class. Occasionally, this creates a problem: some class

2. There are three run-time exceptions that are not changed to `UnknownLocalException` when returned to the client: `ObjectNotExistException`, `OperationNotExistException`, and `FacetNotExistException`. We discuss these exceptions in more detail in Chapter 33.

libraries require you to inherit from a base class in order to access functionality provided by the library; because Java does not support multiple inheritance, this means that you cannot use such a class library to implement your servants because your servants cannot inherit from both the library class and the skeleton class simultaneously.

To allow you to still use such class libraries, Ice provides a way to write servants that replaces inheritance with delegation. This approach is supported by *tie classes*. The idea is that, instead of inheriting from the skeleton class, you simply create a class (known as an *implementation class* or *delegate class*) that contains methods corresponding to the operations of an interface. You use the `--tie` option with the `slice2java` compiler to create a tie class. For example, for the Node interface we saw in Section 12.4.1, the `--tie` option causes the compiler to create exactly the same code as we saw previously, but to also emit an additional tie class. For an interface `<interface-name>`, the generated tie class has the name `_<interface-name>Tie`:

```
package Filesystem;

public class _NodeTie extends _NodeDisp implements Ice.TieBase {

    public _NodeTie() {}

    public
    _NodeTie(_NodeOperations delegate)
    {
        _ice_delegate = delegate;
    }

    public java.lang.Object
    ice_delegate()
    {
        return _ice_delegate;
    }

    public void
    ice_delegate(java.lang.Object delegate)
    {
        _ice_delegate = (_NodeOperations)delegate;
    }

    public boolean
    equals(java.lang.Object rhs)
    {
```

```

        if(this == rhs)
        {
            return true;
        }
        if(!(rhs instanceof _NodeTie))
        {
            return false;
        }

        return _ice_delegate.equals((( _NodeTie)rhs)._ice_delegate)
;
    }

    public int
    hashCode()
    {
        return _ice_delegate.hashCode();
    }

    public String
    name(Ice.Current current)
    {
        return _ice_delegate.name(current);
    }

    private _NodeOperations _ice_delegate;
}

```

This looks a lot worse than it is: in essence, the generated tie class is simply a servant class (it extends `_NodeDisp`) that delegates each invocation of a method that corresponds to a Slice operation to your implementation class (see Figure 12.1).

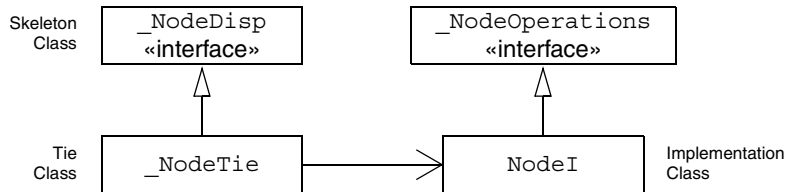

Figure 12.1. A skeleton class, tie class, and implementation class.

The generated tie class also implements the `Ice.TieBase` interface, which defines methods for obtaining and changing the delegate object:

```

package Ice;

public interface TieBase {
    java.lang.Object ice_delegate();
    void ice_delegate(java.lang.Object delegate);
}

```

The delegate has type `java.lang.Object` in these methods in order to allow a tie object's delegate to be manipulated without knowing its actual type. However, the `ice_delegate` modifier raises `ClassCastException` if the given delegate object is not of the correct type.

Given this machinery, we can create an implementation class for our `Node` interface as follows:

```

package Filesystem;

public final class NodeI implements _NodeOperations {
{
    public NodeI(String name)
    {
        _name = name;
    }

    public String name(Ice.Current current)
    {
        return _name;
    }

    private String _name;
}
}

```

Note that this class is identical to our previous implementation, except that it implements the `_NodeOperations` interface and does not extend `_NodeDisp` (which means that you are now free to extend any other class to support your implementation).

To create a servant, you instantiate your implementation class and the tie class, passing a reference to the implementation instance to the tie constructor:

```

NodeI fred = new NodeI("Fred");           // Create implementation
_NodeTie servant = new _NodeTie(fred);    // Create tie

```

Alternatively, you can also default-construct the tie class and later set its delegate instance by calling `ice_delegate`:

```
_NodeTie servant = new _NodeTie();      // Create tie
// ...
NodeI fred = new NodeI("Fred");        // Create implementation
// ...
servant.ice_delegate(fred);            // Set delegate
```

When using tie classes, it is important to remember that the tie instance is the servant, not your delegate. Furthermore, you must not use a tie instance to incarnate (see Section 12.8) an Ice object until the tie has a delegate. Once you have set the delegate, you must not change it for the lifetime of the tie; otherwise, undefined behavior results.

You should use the tie approach only if you need to, that is, if you need to extend some base class in order to implement your servants: using the tie approach is more costly in terms of memory because each Ice object is incarnated by two Java objects instead of one, the tie and the delegate. In addition, call dispatch for ties is marginally slower than for ordinary servants because the tie forwards each operation to the delegate, that is, each operation invocation requires two function calls instead of one.

Also note that, unless you arrange for it, there is no way to get from the delegate back to the tie. If you need to navigate back to the tie from the delegate, you can store a reference to the tie in a member of the delegate. (The reference can, for example, be initialized by the constructor of the delegate.)

12.8 Object Incarnation

Having created a servant class such as the rudimentary `NodeI` class in Section 12.4.2, you can instantiate the class to create a concrete servant that can receive invocations from a client. However, merely instantiating a servant class is insufficient to incarnate an object. Specifically, to provide an implementation of an Ice object, you must take the following steps:

1. Instantiate a servant class.
2. Create an identity for the Ice object incarnated by the servant.
3. Inform the Ice run time of the existence of the servant.
4. Pass a proxy for the object to a client so the client can reach it.

12.8.1 Instantiating a Servant

Instantiating a servant means to allocate an instance:

```
Node servant = new NodeI("Fred");
```

This code creates a new `NodeI` instance and assigns its address to a reference of type `Node`. This works because `NodeI` is derived from `Node`, so a `Node` reference can refer to an instance of type `NodeI`. However, if we want to invoke a member function of the `NodeI` class at this point, we must use a `NodeI` reference:

```
NodeI servant = new NodeI("Fred");
```

Whether you use a `Node` or a `NodeI` reference depends purely on whether you want to invoke a member function of the `NodeI` class: if not, a `Node` reference works just as well as a `NodeI` reference.

12.8.2 Creating an Identity

Each Ice object requires an identity. That identity must be unique for all servants using the same object adapter.³ An Ice object identity is a structure with the following Slice definition:

```
module Ice {
    struct Identity {
        string name;
        string category;
    };
    // ...
};
```

The full identity of an object is the combination of both the name and category fields of the `Identity` structure. For now, we will leave the `category` field as the empty string and simply use the name field. (See Section 31.6 for a discussion of the `category` field.)

To create an identity, we simply assign a key that identifies the servant to the name field of the `Identity` structure:

```
Ice.Identity id = new Ice.Identity();
id.name = "Fred"; // Not unique, but good enough for now
```

3. The Ice object model assumes that all objects (regardless of their adapter) have a globally unique identity. See XREF for further discussion.

12.8.3 Activating a Servant

Merely creating a servant instance does nothing: the Ice run time becomes aware of the existence of a servant only once you explicitly tell the object adapter about the servant. To activate a servant, you invoke the `add` operation on the object adapter. Assuming that we have access to the object adapter in the `_adapter` variable, we can write:

```
_adapter.add(servant, id);
```

Note the two arguments to `add`: the servant and the object identity. Calling `add` on the object adapter adds the servant and the servant's identity to the adapter's servant map and links the proxy for an Ice object to the correct servant instance in the server's memory as follows:

1. The proxy for an Ice object, apart from addressing information, contains the identity of the Ice object. When a client invokes an operation, the object identity is sent with the request to the server.
2. The object adapter receives the request, retrieves the identity, and uses the identity as an index into the servant map.
3. If a servant with that identity is active, the object adapter retrieves the servant from the servant map and dispatches the incoming request into the correct member function on the servant.

Assuming that the object adapter is in the active state (see Section 31.4), client requests are dispatched to the servant as soon as you call `add`.

12.8.4 UUIDs as Identities

As we discussed in Section 2.5.1, the Ice object model assumes that object identities are globally unique. One way of ensuring that uniqueness is to use UUIDs (Universally Unique Identifiers) [14] as identities. The `Ice.Util` package contains a helper function to create such identities:

```
public class Example {
    public static void
    main(String[] args)
    {
        System.out.println(Ice.Util.generateUUID());
    }
}
```

When executed, this program prints a unique string such as `5029a22c-e333-4f87-86b1-cd5e0fcce509`. Each call to `generate-`

UUID creates a string that differs from all previous ones.⁴ You can use a UUID such as this to create object identities. For convenience, the object adapter has an operation `addWithUUID` that generates a UUID and adds a servant to the servant map in a single step. Using this operation, we can create an identity and register a servant with that identity in a single step as follows:

```
_adapter.addWithUUID(new NodeI("Fred"));
```

12.8.5 Creating Proxies

Once we have activated a servant for an Ice object, the server can process incoming client requests for that object. However, clients can only access the object once they hold a proxy for the object. If a client knows the server's address details and the object identity, it can create a proxy from a string, as we saw in our first example in Chapter 3. However, creation of proxies by the client in this manner is usually only done to allow the client access to initial objects for bootstrapping. Once the client has an initial proxy, it typically obtains further proxies by invoking operations.

The object adapter contains all the details that make up the information in a proxy: the addressing and protocol information, and the object identity. The Ice run time offers a number of ways to create proxies. Once created, you can pass a proxy to the client as the return value or as an out-parameter of an operation invocation.

Proxies and Servant Activation

The `add` and `addWithUUID` servant activation operations on the object adapter return a proxy for the corresponding Ice object. This means we can write:

```
NodePrx proxy = NodePrxHelper.uncheckedCast(  
    _adapter.addWithUUID(new NodeI("Fred")));
```

Here, `addWithUUID` both activates the servant and returns a proxy for the Ice object incarnated by that servant in a single step.

Note that we need to use an `uncheckedCast` here because `addWithUUID` returns a proxy of type `Ice.ObjectPrx`.

4. Well, almost: eventually, the UUID algorithm wraps around and produces strings that repeat themselves, but this will not happen until approximately the year 3400.

Direct Proxy Creation

The object adapter offers an operation to create a proxy for a given identity:

```
module Ice {
    local interface ObjectAdapter {
        Object* createProxy(Identity id);
        // ...
    };
};
```

Note that `createProxy` creates a proxy for a given identity whether a servant is activated with that identity or not. In other words, proxies have a life cycle that is quite independent from the life cycle of servants:

```
Ice.Identity id = new Ice.Identity();
id.name = Ice.Util.generateUUID();
Ice.ObjectPrx o = _adapter.createProxy(id);
```

This creates a proxy for an Ice object with the identity returned by `generateUUID`. Obviously, no servant yet exists for that object so, if we return the proxy to a client and the client invokes an operation on the proxy, the client will receive an `ObjectNotExistException`. (We examine these life cycle issues in more detail in XREF.)

12.9 Summary

This chapter presented the server-side Java mapping. Because the mapping for Slice data types is identical for clients and servers, the server-side mapping only adds a few additional mechanism to the client side: a small API to initialize and finalize the run time, plus a few rules for how to derive servant classes from skeletons and how to register servants with the server-side run time.

Even though the examples in this chapter are very simple, they accurately reflect the basics of writing an Ice server. Of course, for more sophisticated servers (which we discuss in Chapter 31), you will be using additional APIs, for example, to improve performance or scalability. However, these APIs are all described in Slice, so, to use these APIs, you need not learn any Java mapping rules beyond those we described here.

Chapter 13

Developing a File System Server in Java

13.1 Chapter Overview

In this chapter, we present the source code for a Java server that implements the file system we developed in Chapter 5 (see Chapter 11 for the corresponding client). The code we present here is fully functional, apart from the required interlocking for threads. (We examine threading issues in detail in Section 31.9.)

13.2 Implementing a File System Server

We have now seen enough of the server-side Java mapping to implement a server for the file system we developed in Chapter 5. (You may find it useful to review the Slice definition for our file system in Section 5 before studying the source code.)

Our server is composed of three source files:

- `Server.java`

This file contains the server main program.

- `Filesystem/DirectoryI.java`

This file contains the implementation for the `Directory` servants.

- Filesystem/FileI.java

This file contains the implementation for the File servants.

13.2.1 The Server main Program

Our server main program, in the file `Server.java`, uses the `Ice.Application` class we discussed in Section 12.3.1. The `run` method installs a shutdown hook, creates an object adapter, instantiates a few servants for the directories and files in the file system, and then activates the adapter. This leads to a main program as follows:

```
import Filesystem.*;

public class Server extends Ice.Application {
    public int
    run(String[] args)
    {
        // Create an object adapter (stored in the _adapter
        // static members)
        //
        Ice.ObjectAdapter adapter
            = communicator().createObjectAdapterWithEndpoints(
                "SimpleFilesystem", "default -p 10000");
        DirectoryI._adapter = adapter;
        FileI._adapter = adapter;

        // Create the root directory (with name "/" and no parent)
        //
        DirectoryI root = new DirectoryI("/", null);

        // Create a file "README" in the root directory
        //
        File file = new FileI("README", root);
        String[] text;
        text = new String[] {
            "This file system contains a collection of poetry."
        };
        try {
            file.write(text, null);
        } catch (GenericError e) {
            System.err.println(e.reason);
        }

        // Create a directory "Coleridge" in the root directory
```

```
//
DirectoryI coleridge
    = new DirectoryI("Coleridge", root);

// Create a file "Kubla_Khan" in the Coleridge directory
//
file = new FileI("Kubla_Khan", coleridge);
text = new String[]{ "In Xanadu did Kubla Khan",
                    "A stately pleasure-dome decree:",
                    "Where Alph, the sacred river, ran",
                    "Through caverns measureless to man",
                    "Down to a sunless sea." };

try {
    file.write(text, null);
} catch (GenericError e) {
    System.err.println(e.reason);
}

// All objects are created, allow client requests now
//
adapter.activate();

// Wait until we are done
//
communicator().waitForShutdown();

return 0;
}

public static void
main(String[] args)
{
    Server app = new Server();
    System.exit(app.main("Server", args));
}
}
```

The code imports the contents of the `Filesystem` package. This avoids having to continuously use fully-qualified identifiers with a `Filesystem.` prefix.

The next part of the source code is the definition of the `Server` class, which derives from `Ice.Application` and contains the main application logic in its `run` method. Much of this code is boiler plate that we saw previously: we create an object adapter, and, towards the end, activate the object adapter and call `waitForShutdown`.

The interesting part of the code follows the adapter creation: here, the server instantiates a few nodes for our file system to create the structure shown in Figure 13.1.

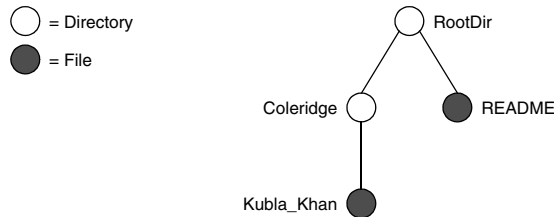

Figure 13.1. A small file system.

As we will see shortly, the servants for our directories and files are of type `DirectoryI` and `FileI`, respectively. The constructor for either type of servant accepts two parameters, the name of the directory or file to be created and a reference to the servant for the parent directory. (For the root directory, which has no parent, we pass a null parent.) Thus, the statement

```
DirectoryI root = new DirectoryI("/", null);
```

creates the root directory, with the name "/" and no parent directory.

Here is the code that establishes the structure in Figure 13.1:

```

// Create the root directory (with name "/" and no parent)
//
DirectoryI root = new DirectoryI("/", null);

// Create a file "README" in the root directory
//
File file = new FileI("README", root);
String[] text;
text = new String[] {
    "This file system contains a collection of poetry."
};
try {
    file.write(text, null);
} catch (GenericError e) {
    System.err.println(e.reason);
}

// Create a directory "Coleridge" in the root directory
//
DirectoryI coleridge

```



```

        = new DirectoryI("Coleridge", root);

// Create a file "Kubla_Khan" in the Coleridge directory
//
file = new FileI("Kubla_Khan", coleridge);
text = new String[]{ "In Xanadu did Kubla Khan",
                    "A stately pleasure-dome decree:",
                    "Where Alph, the sacred river, ran",
                    "Through caverns measureless to man",
                    "Down to a sunless sea." };

try {
    file.write(text, null);
} catch (GenericError e) {
    System.err.println(e.reason);
}

```

We first create the root directory and a file `README` within the root directory. (Note that we pass a reference to the root directory as the parent when we create the new node of type `FileI`.)

The next step is to fill the file with text:

```

String[] text;
text = new String[] {
    "This file system contains a collection of poetry."
};
try {
    file.write(text, null);
} catch (GenericError e) {
    System.err.println(e.reason);
}

```

Recall from Section 10.7.3 that `Slice` sequences by default map to Java arrays. The `Slice` type `Lines` is simply an array of strings; we add a line of text to our `README` file by initializing the `text` array to contain one element.

Finally, we call the `Slice` `write` operation on our `FileI` servant by simply writing:

```
file.write(text, null);
```

This statement is interesting: the server code invokes an operation on one of its own servants. Because the call happens via a reference to the servant (of type `FileI`) and *not* via a proxy (of type `FilePrx`), the Ice run time does not know that this call is even taking place—such a direct call into a servant is not mediated by the Ice run time in any way and is dispatched as an ordinary Java function call.

In similar fashion, the remainder of the code creates a subdirectory called Coleridge and, within that directory, a file called Kubla_Khan to complete the structure in Figure 13.1.

13.2.2 The FileI Servant Class

Our FileI servant class has the following basic structure:

```
public class FileI extends _FileDisp
{
    // Constructor and operations here...

    public static Ice.ObjectAdapter _adapter;
    private String _name;
    private DirectoryI _parent;
    private String[] _lines;
}
```

The class has a number of data members:

- `_adapter`
This static member stores a reference to the single object adapter we use in our server.
- `_name`
This member stores the name of the file incarnated by the servant.
- `_parent`
This member stores the reference to the servant for the file's parent directory.
- `_lines`
This member holds the contents of the file.

The `_name` and `_parent` data members are initialized by the constructor:

```
public
FileI(String name, DirectoryI parent)
{
    _name = name;
    _parent = parent;

    assert(_parent != null);

    // Create an identity
    //
    Ice.Identity myID
```

```

        = Ice.Util.stringToIdentity(Ice.Util.generateUUID());

    // Add the identity to the object adapter
    //
    _adapter.add(this, myID);

    // Create a proxy for the new node and
    // add it as a child to the parent
    //
    NodePrx thisNode
        = NodePrxHelper.uncheckedCast(_adapter.createProxy(myID));
    _parent.addChild(thisNode);
}

```

After initializing the `_name` and `_parent` members, the code verifies that the reference to the parent is not null because every file must have a parent directory. The constructor then generates an identity for the file by calling `Ice.Util.generateUUID` and adds itself to the servant map by calling `ObjectAdapter.add`. Finally, the constructor creates a proxy for this file and calls the `addChild` method on its parent directory. `addChild` is a helper function that a child directory or file calls to add itself to the list of descendant nodes of its parent directory. We will see the implementation of this function on page 391.

The remaining methods of the `FileI` class implement the Slice operations we defined in the `Node` and `File Slice` interfaces:

```

// Slice Node::name() operation

public String
name(Ice.Current current)
{
    return _name;
}

// Slice File::read() operation

public String[]
read(Ice.Current current)
{
    return _lines;
}

// Slice File::write() operation

public void

```

```

write(String[] text, Ice.Current current)
    throws GenericError
{
    _lines = text;
}

```

The `name` method is inherited from the generated `Node` interface (which is a base interface of the `_FileDisp` class from which `FileI` is derived). It simply returns the value of the `_name` member.

The `read` and `write` methods are inherited from the generated `File` interface (which is a base interface of the `_FileDisp` class from which `FileI` is derived) and simply return and set the `_lines` member.

13.2.3 The DirectoryI Servant Class

The `DirectoryI` class has the following basic structure:

```

package Filesystem;

public final class DirectoryI extends _DirectoryDisp
{
    // Constructor and operations here...

    public static Ice.ObjectAdapter _adapter;
    private String _name;
    private DirectoryI _parent;
    private java.util.ArrayList _contents
        = new java.util.ArrayList();
}

```

As for the `FileI` class, we have data members to store the object adapter, the name, and the parent directory. (For the root directory, the `_parent` member holds a null reference.) In addition, we have a `_contents` data member that stores the list of child directories. These data members are initialized by the constructor:

```

public
DirectoryI(String name, DirectoryI parent)
{
    _name = name;
    _parent = parent;

    // Create an identity. The parent has the
    // fixed identity "RootDir"
    //

```

```

Ice.Identity myID
    = Ice.Util.stringToIdentity(_parent != null ?
                               Ice.Util.generateUUID() : "RootDir");

// Add the identity to the object adapter
//
_adapter.add(this, myID);

// Create a proxy for the new node and add it as a
// child to the parent
//
NodePrx thisNode
    = NodePrxHelper.uncheckedCast(_adapter.createProxy(myID));
if (_parent != null)
    _parent.addChild(thisNode);
}

```

The constructor creates an identity for the new directory by calling `Ice.Util.generateUUID`. (For the root directory, we use the fixed identity "RootDir".) The servant adds itself to the servant map by calling `ObjectAdapter.add` and then creates a reference to itself and passes it to the `addChild` helper function.

`addChild` simply adds the passed reference to the `_contents` list:

```

void
addChild(NodePrx child)
{
    _contents.add(child);
}

```

The remainder of the operations, `name` and `list`, are trivial:

```

public String
name(Ice.Current current)
{
    return _name;
}

// Slice Directory::list() operation

public NodePrx[]
list(Ice.Current current)
{

```

```
NodePrx[] result = new NodePrx[_contents.size()];
_contents.toArray(result);
return result;
}
```

Note that the `_contents` member is of type `java.util.ArrayList`, which is convenient for the implementation of the `addChild` method. However, this requires us to convert the list into a Java array in order to return it from the `list` operation.

13.3 Summary

This chapter showed how to implement a complete server for the file system we defined in Chapter 5. Note that the server is remarkably free of code that relates to distribution: most of the server code is simply application logic that would be present just the same for a non-distributed version. Again, this is one of the major advantages of Ice: distribution concerns are kept away from application code so that you can concentrate on developing application logic instead of networking infrastructure.

Note that the server code we presented here is not quite correct as it stands: if two clients access the same file in parallel, each via a different thread, one thread may read the `_lines` data member while another thread updates it. Obviously, if that happens, we may write or return garbage or, worse, crash the server. However, it is trivial to make the `read` and `write` operations thread-safe. We discuss thread safety in Section 31.9.

Part III.C

C# Mapping

Chapter 14

Client-Side Slice-to-C# Mapping

14.1 Chapter Overview

In this chapter, we present the client-side Slice-to-C# mapping (see Chapter 16 for the server-side mapping). One part of the client-side C# mapping concerns itself with rules for representing each Slice data type as a corresponding C# type; we cover these rules in Section 14.3 to Section 14.10. Another part of the mapping deals with how clients can invoke operations, pass and receive parameters, and handle exceptions. These topics are covered in Section 14.11 to Section 14.13. Slice classes have the characteristics of both data types and interfaces and are covered in Section 14.14.

14.2 Introduction

The client-side Slice-to-C# mapping defines how Slice data types are translated to C# types, and how clients invoke operations, pass parameters, and handle errors. Much of the C# mapping is intuitive. For example, Slice dictionaries map to a C# class that derives from `System.Collections.DictionaryBase`, so there is little you have learn in order to use Slice dictionaries in C#.

The C# API to the Ice run time is fully thread-safe. Obviously, you must still synchronize access to data from different threads. For example, if you have two

threads sharing a sequence, you cannot safely have one thread insert into the sequence while another thread is iterating over the sequence. However, you only need to concern yourself with concurrent access to your own data—the Ice run time itself is fully thread safe, and none of the Ice API calls require you to acquire or release a lock before you safely can make the call.

Much of what appears in this chapter is reference material. We suggest that you skim the material on the initial reading and refer back to specific sections as needed. However, we recommend that you read at least Section 14.10 to Section 14.13 in detail because these sections cover how to call operations from a client, pass parameters, and handle exceptions.

A word of advice before you start: in order to use the C# mapping, you should need no more than the Slice definition of your application and knowledge of the C# mapping rules. In particular, looking through the generated code in order to discern how to use the C# mapping is likely to be inefficient, due to the amount of detail. Of course, occasionally, you may want to refer to the generated code to confirm a detail of the mapping, but we recommend that you otherwise use the material presented here to see how to write your client-side code.

14.3 Mapping for Identifiers

Slice identifiers map to an identical C# identifier. For example, the Slice identifier `Clock` becomes the C# identifier `Clock`. If a Slice identifier is the same as a C# keyword, the corresponding C# identifier is a *verbatim identifier* (an identifier prefixed with `@`). For example, the Slice identifier `while` is mapped as `@while`.¹

The Slice-to-C# compiler generates classes that inherit from interfaces or base classes in the .NET framework. These interfaces and classes introduce a number of methods into derived classes. To avoid name clashes between Slice identifiers that happen to be the same as an inherited method, such identifiers are prefixed with `ice_` and suffixed with `_` in the generated code. For example, the Slice identifier `Clone` maps to the VB identifier `ice_Clone_` if it would clash with an inherited `Clone`. The complete list of identifiers that are so changed is:

<code>Clone</code>	<code>Equals</code>	<code>Finalize</code>
<code>GetBaseException</code>	<code>GetHashCode</code>	<code>GetObjectData</code>

1. As suggested in Section 4.5.3 on page 86, you should try to avoid such Slice identifiers as much as possible.

GetType	MemberwiseClone	ReferenceEquals
ToString	checkedCast	uncheckedCast

Note that Slice identifiers in this list are translated to the corresponding C# identifier only where necessary. For example, structures do not derive from `ICloneable`, so if a Slice structure contains a member named `Clone`, the corresponding C# structure's member is named `Clone` as well. On the other hand, classes do derive from `ICloneable`, so, if a Slice class contains a member named `Clone`, the corresponding C# class's member is named `ice_Clone_`.

Also note that, for the purpose of prefixing, Slice identifiers are case-insensitive, that is, both `Clone` and `clone` are escaped and map to `ice_Clone_` and `ice_clone_`, respectively.

14.4 Mapping for Modules

Slice modules map to C# namespaces with the same name as the Slice module. The mapping preserves the nesting of the Slice definitions. For example:

```
module M1 {
    // Definitions for M1 here...
    module M2 {
        // Definitions for M2 here...
    };
};

// ...

module M1 { // Reopen M1
    // More definitions for M1 here...
};
```

This definition maps to the corresponding C# definitions:

```
namespace M1
{
    namespace M2
    {
        // ...
    }
    // ...
}

// ...
```

```
namespace M1    // Reopen M1
{
    // ...
}
```

If a Slice module is reopened, the corresponding C# namespace is reopened as well.

14.5 The Ice Namespace

All of the APIs for the Ice run time are nested in the Ice namespace, to avoid clashes with definitions for other libraries or applications. Some of the contents of the Ice namespace are generated from Slice definitions; other parts of the Ice namespace provide special-purpose definitions that do not have a corresponding Slice definition. We will incrementally cover the contents of the Ice namespace throughout the remainder of the book.

14.6 Mapping for Simple Built-In Types

The Slice built-in types are mapped to C# types as shown in Table 14.1.

Table 14.1. Mapping of Slice built-in types to C#.

Slice	C#
bool	bool
byte	byte
short	short
int	int
long	long
float	float

Table 14.1. Mapping of Slice built-in types to C#.

Slice	C#
double	double
string	string

14.7 Mapping for User-Defined Types

Slice supports user-defined types: enumerations, structures, sequences, and dictionaries.

14.7.1 Mapping for Enumerations

Enumerations map to the corresponding enumeration in C#. For example:

```
enum Fruit { Apple, Pear, Orange };
```

Not surprisingly, the generated C# definition is identical:

```
enum Fruit { Apple, Pear, Orange };
```

14.7.2 Mapping for Structures

Ice for C# supports two different mappings for structures. By default, Slice structures map to C# structures if they (recursively) contain only value types. If a Slice structure (recursively) contains a string, proxy, class, sequence, or dictionary member, it maps to a C# class. A metadata directive (see Section 4.17) allows you to force the mapping to a C# class for Slice structures that contain only value types.

In addition, for either mapping, you can control whether Slice data members are mapped to fields or to properties (see page 402).

Structure Mapping for Structures

Consider the following structure:

```
struct Point {  
    double x;  
    double y;  
};
```

This structure consist of only value types and so, by default, maps to a C# structure:

```
public struct Point  
{  
    public double x;  
    public double y;  
  
    public Point(double x, double y);  
  
    public override int GetHashCode();  
    public override bool Equals(object other);  
  
    public static bool operator==(Point lhs, Point rhs);  
    public static bool operator!=(Point lhs, Point rhs);  
}
```

For each data member in the Slice definition, the C# structure contains a corresponding public data member of the same name.

The generated constructor accepts one argument for each structure member, in the order in which they are defined in the Slice definition. This allows you to construct and initialize a structure in a single statement:

```
Point p = new Point(5.1, 7.8);
```

The structure overrides the `GetHashCode` and `Equals` methods to allow you to use it as the key type of a dictionary. (Note that the static two-argument version of `Equals` is inherited from `System.Object`.) Two structures are equal if (recursively) all their data members are equal. Otherwise, they are not equal. For structures that contain reference types, `Equals` performs a deep comparison; that is, reference types are compared for value equality, not reference equality.

Class Mapping for Structures

The mapping for Slice structures to C# structures provides value semantics. Usually, this is appropriate, but there are situations where you may want to change this:

- If you use structures as members of a collection, each access to an element of the collection incurs the cost of boxing or unboxing. Depending on your situation, the performance penalty may be noticeable.

- On occasion, it is useful to be able to assign null to a structure, for example, to support “not there” semantics (such as when implementing parameters that are conceptually optional).

To allow you to choose the correct performance and functionality trade-off, the Slice-to-C# compiler provides an alternative mapping of structures to classes, for example:

```
["clr:class"] struct Point {  
    double x;  
    double y;  
};
```

The "clr:class" metadata directive instructs the Slice-to-C# compiler to generate a mapping to a C# class for this structure. The generated code is identical, except that the keyword `struct` is replaced by the keyword `class`² and that the class also inherits from `ICloneable`:

```
public class Point : _System.ICloneable  
{  
    public double x;  
    public double y;  
  
    public Point();  
    public Point(double x, double y);  
  
    public object Clone();  
  
    public override int GetHashCode();  
    public override bool Equals(object other);  
  
    public static bool operator==(Point lhs, Point rhs);  
    public static bool operator!=(Point lhs, Point rhs);  
}
```

The `Clone` method performs a shallow memberwise copy, and the comparison methods have the usual semantics (they perform value comparison).

Note that you can influence the mapping for structures only at the point of definition of a structure, that is, for a particular structure type, you must decide whether you want to use the structure or the class mapping. (You cannot override

2. Some of the generated marshaling code differs for the class mapping of structures, but this is irrelevant to application code.

the structure mapping elsewhere, for example, for individual structure members or operation parameters.)

As we mentioned previously, if a Slice structure (recursively) contains a member of reference type, it is automatically mapped to a C# class. (The compiler behaves as if you had explicitly specified the “`clr:class`” metadata directive for the structure.)

Here is our `Employee` structure from Section 4.9.4 once more:

```
struct Employee {
    long number;
    string firstName;
    string lastName;
};
```

The structure contains two strings, which are reference types, so the Slice-to-C# compiler generates a C# class for this structure:

```
public class Employee : _System.ICloneable
{
    public long number;
    public string firstName;
    public string lastName;

    public Employee();
    public Employee(long number,
                    string firstName,
                    string lastName);

    public object Clone();

    public override int GetHashCode();
    public override bool Equals(object other);

    public static bool operator==(Employee lhs, Employee rhs);
    public static bool operator!=(Employee lhs, Employee rhs);
}
```

Property Mapping for Structures

You can instruct the compiler to emit property definitions instead of public data members. For example:

```
["clr:property"] struct Point {
    double x;
    double y;
};
```

The “clr:property” metadata directive causes the compiler to generate a property for each Slice data member:

```
public struct Point
{
    private double x_prop;
    public double x {
        get {
            return x_prop;
        }
        set {
            x_prop = value;
        }
    }

    private double y_prop;
    public double y {
        get {
            return y_prop;
        }
        set {
            y_prop = value;
        }
    }

    // Other methods here...
}
```

Note that the properties are non-virtual because C# structures cannot have virtual properties. However, if you apply the “clr:property” directive to a structure that contains a member of reference type, or if you combine the “clr:property” and “clr:class” directives, the generated properties are virtual. For example:

```
["clr:property", "clr:class"]
struct Point {
    double x;
    double y;
};
```

This generates the following code:

```
public class Point : System.ICloneable
{
    private double x_prop;
    public virtual double x {
        get {
            return x_prop;
        }
    }
}
```

```
    }
    set {
        x_prop = value;
    }
}

private double y_prop;
public virtual double y {
    get {
        return y_prop;
    }
    set {
        y_prop = value;
    }
}

// Other methods here...
}
```

14.7.3 Mapping for Sequences

Ice for C# supports two different mappings for sequences. By default, sequences are mapped to arrays. A metadata directive (see Section 4.17) allows you to instead map sequences to classes that are derived from `System.Collections.CollectionBase`.

Array Mapping for Sequences

By default, the Slice-to-C# compiler maps sequences to arrays. Interestingly, no code is generated in this case; you simply define an array of elements to model the Slice sequence. For example:

```
sequence<Fruit> FruitPlatter;
```

Given this definition, to create a sequence containing an apple and an orange, you could write:

```
Fruit[] fp = { Fruit.Apple, Fruit.Orange };
```

Or, alternatively:

```
Fruit fp[] = new Fruit[2];
fp[0] = Fruit.Apple;
fp[1] = Fruit.Orange;
```

The array mapping for sequences is both simple and efficient, especially for sequences of value types because accessing array elements does not require boxing and unboxing.

CollectionBase Mapping for Sequences

The mapping of sequences to arrays is simple, but has the disadvantage that the number of elements in the sequence is fixed when you instantiate the array. This makes the array mapping useless in situations where you need to grow and shrink a sequence on demand. To allow you to choose the correct feature trade-off, the Slice-to-C# compiler provides an alternative mapping, for example:

```
["clr:collection"] sequence<Fruit> FruitPlatter;
```

The "clr:collection" metadata directive instructs the Slice-to-C# compiler to generate a mapping to a C# class that derives from `System.Collections.CollectionBase`:

```
public class FruitPlatter : System.Collections.CollectionBase,
                          System.ICloneable
{
    public FruitPlatter();
    public FruitPlatter(int capacity);
    public FruitPlatter(Fruit[] a);

    public void CopyTo(Fruit[] a);
    public void CopyTo(Fruit[] a, int i);
    public void CopyTo(int i, Fruit[] a, int ai, int c);

    public Fruit[] ToArray();

    public void AddRange(FruitPlatter s);
    public void AddRange(Fruit[] a);

    public Fruit this[int index] { get; set; }

    public int Add(Fruit value);
    public int IndexOf(Fruit value);
    public void Insert(int index, Fruit value);
    public void Remove(Fruit value);
    public bool Contains(Fruit value);

    public virtual int Capacity { get; set; }

    public virtual void TrimToSize();
}
```

```
public virtual void Sort()  
public virtual void Sort(System.Collections.IComparer comparer  
)  
public virtual void Sort(int index, int count,  
                          System.Collections.IComparer comparer  
)  
  
public virtual void Reverse()  
public virtual void Reverse(int index, int count)  
  
public virtual int BinarySearch(Fruit value)  
public virtual int BinarySearch(Fruit value, System.Collectio  
n.IComparer comparer)  
public virtual int BinarySearch(int index, int count,  
                                Fruit value,  
                                System.Collections.IComparer c  
omparer)  
  
public virtual void InsertRange(int index, FruitPlatter c)  
public virtual void InsertRange(int index, Fruit[] c)  
  
public virtual void RemoveRange(int index, int count)  
public virtual FruitPlatter GetRange(int index, int count)  
  
public virtual void SetRange(int index, FruitPlatter c)  
public virtual void SetRange(int index, Fruit[] c)  
  
public virtual int LastIndexOf(Fruit value)  
public virtual int LastIndexOf(Fruit value, int startIndex)  
public virtual int LastIndexOf(Fruit value, int startIndex, in  
t count)  
  
public static FruitPlatter Repeat(Fruit value, int count)  
  
public object Clone();  
  
public override int GetHashCode();  
public override bool Equals(object other);  
  
public static bool Equals(FruitPlatter lhs,  
                          FruitPlatter rhs);  
public static bool operator==(FruitPlatter lhs,  
                              FruitPlatter rhs);  
public static bool operator!=(FruitPlatter lhs,
```

```

        FruitPlatter rhs);

    // ...
}

```

The generated `FruitPlatter` class provides implementations of the indexer (get and set methods), and the inherited `Add`, `IndexOf`, `Insert`, `Remove`, and `Contains` methods. (The `CollectionBase` base class provides implementations of yet more methods, such as `RemoveAt` and `Clear`.) To make sequences easier to use, the Slice-to-C# compiler adds a number of additional properties and methods:

- `FruitPlatter()`;
`FruitPlatter(int capacity)`;
`FruitPlatter(Fruit[] a)`;

Apart from calling the default constructor, you can also specify an initial capacity for the sequence or, using the array constructor, initialize a sequence from an array.

- `void CopyTo(Fruit[] a)`;
`void CopyTo(Fruit[] a, int i)`;
`void CopyTo(int i, Fruit[] a, int ai, int c)`;

These methods copy the contents of a sequence into an array. The semantics are the same as for the corresponding methods on `System.Collections.ArrayList`.

- `Fruit[] ToArray()`;

The `ToArray` method returns the contents of the sequence as an array.

- `void AddRange(FruitPlatter s)`;
`void AddRange(Fruit[] a)`;

The `AddRange` methods append the contents of a sequence or an array to the current sequence, respectively.

- `int Capacity { get; set }`

This property controls the capacity of the sequence. Its semantics are as for `System.Collections.ArrayList`.

- `virtual void TrimToSize()`;

This method sets the capacity of the sequence to the actual number of elements.

- `virtual void Sort()`;
`virtual void Sort(System.Collections.IComparer`

```

        comparer);
    virtual void Sort(int index, int count,
        System.Collections.IComparer comparer);

```

These methods sort the sequence.

- `virtual void Reverse();`
`virtual void Reverse(int index, int count);`

These methods reverse the order of elements of the sequence.

- `virtual int BinarySearch(Fruit value);`
`virtual int BinarySearch(Fruit value,`
 `System.Collections.IComparer comparer);`
`virtual int BinarySearch(int index, int count,`
 `Fruit value,`
 `System.Collections.IComparer comparer);`

The methods perform a binary search on the sequence, with semantics as for `System.Collections.ArrayList`.

- `virtual void InsertRange(int index, FruitPlatter c);`
`virtual void InsertRange(int index, Fruit[] c);`

These methods insert a range of values into the sequence starting at the given index.

- `virtual void RemoveRange(int index, int count);`
 This method removes `count` elements, starting at the given index.
- `virtual FruitPlatter GetRange(int index, int count);`
 This method returns a subrange of the sequence. Note that, unlike `System.Collections.ArrayList.GetRange`, this method returns an independent copy of the subrange instead of a view on the underlying sequence.

- `virtual void SetRange(int index, FruitPlatter c);`
`virtual void SetRange(int index, Fruit[] c);`

These methods copy the provided sequence over a range of elements in the target sequence, starting at the provided index, with semantics as for `System.Collections.ArrayList`

- `virtual int LastIndexOf(Fruit value);`
`virtual int LastIndexOf(Fruit value,`
 `int startIndex);`

```
virtual int LastIndexOf(Fruit value, int startIndex,
    int count);
```

These methods search for the provided element and return its last occurrence in the sequence, as for

```
System.Collections.ArrayList.LastIndexOf.
```

- `static FruitPlatter Repeat(Fruit value, int count);`

This method returns a sequence with `count` elements that are initialized to `value`.

Note that all these methods perform a shallow copy, that is, if you have a sequence whose elements have reference type, what is copied are the references, not the objects denoted by those references.

The generated class also provides the usual `GetHashCode` and `Equals` methods, as well as the comparison operators for equality and inequality. (Two sequences are equal if they have the same number of elements and all elements in corresponding positions are equal.)

The `Clone` method performs a shallow copy.

The class also implements the inherited `IsFixedSize`, `IsReadOnly`, and `IsSynchronized` properties (which return `false`), and the inherited `SyncRoot` property (which returns `this`).

Creating a sequence containing an apple and an orange is simply a matter of writing:

```
FruitPlatter fp = new FruitPlatter();
fp.Add(Fruit.Apple);
fp.Add(Fruit.Orange);
```

Which Mapping to Choose?

Note that you can influence the mapping for sequences only at the point of definition of a sequence, that is, you must decide up front whether you want to use the `CollectionBase` or the array mapping for a particular sequence type. (You cannot override the sequence mapping elsewhere, for example, for individual structure members or operation parameters.)

Note that the convenience of the `CollectionBase` mapping is not without its cost: sequences of value types (such as a sequence of `int`) are considerably slower for insertion and removal of elements than arrays, due to the cost of boxing and unboxing of the values. Depending on the access patterns, the array mapping can also be noticeably faster for sequences of reference types.

In general, you must use the sequence mapping if you require a sequence whose number of elements can change during its lifetime. The array mapping for sequences is appropriate if the following conditions are met:

- The sequence has a fixed number of elements during its life time.
- The sequence is used in code that is highly performance-critical.

In practice, the array mapping for sequences is likely to yield a performance gain if the element type is a value type. For example, if you are using a `sequence<byte>` to model buffers for transmission of (large) binary data, the array mapping is likely to be considerably faster.

Multi-Dimensional Sequences

Slice permits you to define sequences of sequences, for example:

```
enum Fruit { Apple, Orange, Pear };
["clr:collection"] sequence<Fruit> FruitPlatter;
["clr:collection"] sequence<FruitPlatter> Cornucopia;
```

If we use these definitions as shown, the generated code for the `Cornucopia` sequence (with some details removed for clarity) looks as follows:

```
public class Cornucopia : System.Collections.CollectionBase,
                        System.ICloneable
{
    public FruitPlatter this[int index] { get; set; }

    public int Add(FruitPlatter value);
    public int IndexOf(FruitPlatter value);
    public void Insert(int index, FruitPlatter value);
    public void Remove(FruitPlatter value);
    public bool Contains(FruitPlatter value);

    // ...
}
```

As you can see, the `Cornucopia` class deals with elements of type `FruitPlatter`, as you would expect.

Now let us modify the definition to change the mapping of `FruitPlatter` to an array:

```
enum Fruit { Apple, Orange, Pear };
sequence<Fruit> FruitPlatter;
["clr:collection"] sequence<FruitPlatter> Cornucopia;
```

With this definition, the generated code for `Cornucopia` looks as follows (again, with some details removed for clarity):

```
public class Cornucopia : System.Collections.CollectionBase,
                        System.ICloneable
{
    public Fruit[] this[int index] { get; set; }

    public int Add(Fruit[] value);

    public int IndexOf(Fruit[] value);
    public void Insert(int index, Fruit[] value);
    public void Remove(Fruit[] value);
    public bool Contains(Fruit[] value);

    // ...
}
```

As you can see, the generated code now no longer mentions the type `FruitPlatter` anywhere and deals with the `Cornucopia` elements as an array of `Fruit` instead.

Of course, we could also change the metadata directive to make the `Cornucopia` sequence an array, and use the `CollectionBase` mapping for `FruitPlatter`. In that case, the compiler does not generate any definitions for `Cornucopia` at all—there is no need to generate anything because the application code now has to treat `Cornucopia` as an array of `FruitPlatter` throughout.

14.8 Mapping for Dictionaries

Here is the definition of our `EmployeeMap` from Section 4.9.4 once more:

```
dictionary<long, Employee> EmployeeMap;
```

The Slice-to-C# compiler maps the dictionary to a class with the same name:

```
public class EmployeeMap : System.Collections.DictionaryBase,
                        System.ICloneable
{
    public Employee this[long key] { get; set; }

    public System.Collections.ICollection Keys { get; }
    public System.Collections.ICollection Values { get; }

    public void AddRange(EmployeeMap d);
}
```

```
public void Add(long key, Employee value);
public void Remove(long key);
public bool Contains(long key);

public object Clone();

public override int GetHashCode();
public override bool Equals(object other);

public static bool Equals(EmployeeMap lhs,
                          EmployeeMap rhs);
public static bool operator==(EmployeeMap lhs,
                              EmployeeMap rhs);
public static bool operator!=(EmployeeMap lhs,
                              EmployeeMap rhs);
}
```

Note that the generated `EmployeeMap` class inherits from `DictionaryBase`, so it follows the standard conventions of the .NET framework. Apart from methods inherited from `DictionaryBase`, the class provides an `AddRange` method that allows you to append the contents of one dictionary to another. If the target dictionary contains a key that is also in the source dictionary, the target dictionary's value is preserved. For example:

```
Employee e1 = new Employee();
e1.number = 42;
e1.firstName = "Herb";
e1.lastName = "Sutter";

EmployeeMap em1 = new EmployeeMap();
em1[42] = e;

Employee e2 = new Employee();
e2.number = 42;
e2.firstName = "Stan";
e2.lastName = "Lipmann";

EmployeeMap em2 = new EmployeeMap();
em2[42] = e2;

// Add contents of em2 to em1
//
em1.AddRange(em2);
```

```
// Equal keys preserve the original value
//
Debug.Assert(eml[42].firstName.Equals("Herb"));
```

The generated class also provides the usual `GetHashCode` and `Equals` methods, as well as the comparison operators for equality and inequality. (Two dictionaries are equal if they contain the same number of entries and, for each entry, the key and value are the same.)

The `Clone` method performs a shallow copy.

The class also implements the inherited `IsFixedSize`, `IsReadOnly`, and `IsSynchronized` properties (which return false), and the inherited `SyncRoot` property (which returns `this`).

14.9 Mapping for Constants

Here are the constant definitions we saw in Section 4.9.5 on page 97 once more:

```
const bool      AppendByDefault = true;
const byte      LowerNibble = 0x0f;
const string    Advice = "Don't Panic!";
const short     TheAnswer = 42;
const double    PI = 3.1416;
```

```
enum Fruit { Apple, Pear, Orange };
const Fruit    FavoriteFruit = Pear;
```

Here are the generated definitions for these constants:

```
public abstract class AppendByDefault
{
    public const bool value = true;
}

public abstract class LowerNibble
{
    public const byte value = 15;
}

public abstract class Advice
{
    public const string value = "Don't Panic!";
}
```

```
public abstract class TheAnswer
{
    public const short value = 42;
}

public abstract class PI
{
    public const double value = 3.1416;
}

public enum Fruit { Apple, Pear, Orange }

public abstract class FavoriteFruit
{
    public const Fruit value = Fruit.Pear;
}
```

As you can see, each Slice constant is mapped to a class with the same name as the constant. The class contains a member named `value` that holds the value of the constant.³

3. The mapping to classes instead of to plain constants is necessary because C# does not permit constant definitions at namespace scope.

14.10 Mapping for Exceptions

The mapping for exceptions is based on the inheritance hierarchy shown in Figure 14.1

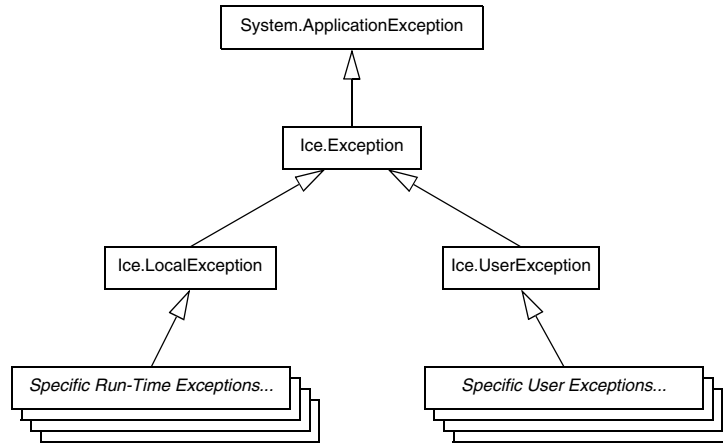

Figure 14.1. Inheritance structure for exceptions.

The ancestor of all exceptions is `System.ApplicationException`. Derived from that is `Ice.Exception`, which provides the definitions for a number of constructors. `Ice.LocalException` and `Ice.UserException` are derived from `Ice.Exception` and form the base for all run-time and user exceptions.

The constructors defined in `Ice.Exception` have the following signatures:

```

public abstract class Exception : System.ApplicationException
{
    public Exception();
    public Exception(string msg);
    public Exception(System.Exception ex);
    public Exception(string msg, System.Exception ex);
}
  
```

Each concrete derived exception class implements these constructors. The constructors initialize the `Message` and `InnerException` properties of `ApplicationException`. (The default constructor initializes the `Message` property to the name of the exception.)

Here is a fragment of the Slice definition for our world time server from Section 4.10.5 on page 113 once more:

```
exception GenericError {
    string reason;
};

exception BadTimeVal extends GenericError {};

exception BadZoneName extends GenericError {};
```

These exception definitions map as follows:

```
public class GenericError : Ice.UserException
{
    public string reason;

    public GenericError();
    public GenericError(string msg);
    public GenericError(System.Exception ex);
    public GenericError(string msg, System.Exception ex);

    // GetHashCode and comparison methods defined here,
    // as well as mapping-internal methods.
}

public class BadTimeVal : GenericError
{
    public BadTimeVal();
    public BadTimeVal(string msg);
    public BadTimeVal(System.Exception ex);
    public BadTimeVal(string msg, System.Exception ex);

    // GetHashCode and comparison methods defined here,
    // as well as mapping-internal methods.
}

public class BadZoneName : GenericError
{
    public BadZoneName();
    public BadZoneName(string msg);
    public BadZoneName(System.Exception ex);
    public BadZoneName(string msg, System.Exception ex);
}
```

```
    // GetHashCode and comparison methods defined here,  
    // as well as mapping-internal methods.  
}
```

Each Slice exception is mapped to a C# class with the same name. For each exception member, the corresponding class contains a public data member. (Obviously, because `BadTimeVal` and `BadZoneName` do not have members, the generated classes for these exceptions also do not have members.)

The inheritance structure of the Slice exceptions is preserved for the generated classes, so `BadTimeVal` and `BadZoneName` inherit from `GenericError`.

All user exceptions are derived from the base class `Ice.UserException`. This allows you to catch all user exceptions generically by installing a handler for `Ice.UserException`. Similarly, you can catch all Ice run-time exceptions with a handler for `Ice.LocalException`, and you can catch all Ice exceptions with a handler for `Ice.Exception`.

All exceptions also provide the usual `GetHashCode` and `Equals` methods, as well as the `==` and `!=` comparison operators.

The generated exception classes also contain other member functions that are not shown here; these member functions are internal to the C# mapping and are not meant to be called by application code.

14.11 Mapping for Interfaces

On the client side, Slice interfaces map to C# interfaces with member functions that correspond to the operations on those interfaces. Consider the following simple interface:

```
interface Simple {  
    void op();  
};
```

The Slice compiler generates the following definition for use by the client:

```
public interface SimplePrx : Ice.ObjectPrx  
{  
    void op();  
    void op(Ice.Context __context);  
}
```

As you can see, the compiler generates a *proxy interface* `SimplePrx`. In general, the generated name is `<interface-name>Prx`. If an interface is nested in a module `M`, the generated interface is part of namespace `M`, so the fully-qualified name is `M.<interface-name>Prx`.

In the client's address space, an instance of `SimplePrx` is the local ambassador for a remote instance of the `Simple` interface in a server and is known as a *proxy instance*. All the details about the server-side object, such as its address, what protocol to use, and its object identity are encapsulated in that instance.

Note that `SimplePrx` inherits from `Ice.ObjectPrx`. This reflects the fact that all `Ice` interfaces implicitly inherit from `Ice::Object`.

For each operation in the interface, the proxy class has a member function of the same name. For the preceding example, we find that the operation `op` has been mapped to the method `op`. Also note that `op` is overloaded: the second version of `op` has a parameter `__context` of type `Ice.Context`. This parameter is for use by the `Ice` run time to store information about how to deliver a request. You normally do not need to use it. (We examine the `__context` parameter in detail in Chapter 31. The parameter is also used by `IceStorm`—see Chapter 43.)

Because all the `<interface-name>Prx` types are interfaces, you cannot instantiate an object of such a type. Instead, proxy instances are always instantiated on behalf of the client by the `Ice` run time, so client code never has any need to instantiate a proxy directly. The proxy references handed out by the `Ice` run time are always of type `<interface-name>Prx`; the concrete implementation of the interface is part of the `Ice` run time and does not concern application code.

14.11.1 The `Ice.ObjectPrx` Interface

All `Ice` objects have `Object` as the ultimate ancestor type, so all proxies inherit from `Ice.ObjectPrx`. `ObjectPrx` provides a number of methods:

```
namespace Ice
{
    public interface ObjectPrx
    {
        Identity ice_getIdentity();
        int ice_getHash();
        bool ice_isA(string id);
        string ice_id();
        void ice_ping();

        int GetHashCode();
        bool Equals(object r);
    }
}
```



```

        // Defined in a helper class:
        //
        public static bool Equals(Ice.ObjectPrx lhs,
                                Ice.ObjectPrx rhs);
        public static bool operator==(ObjectPrx lhs,
                                      ObjectPrx rhs);
        public static bool operator!=(ObjectPrx lhs,
                                      ObjectPrx rhs);

        // ...
    }
}

```

Note that the static methods are not actually defined `Ice.ObjectPrx`, but in a helper class that becomes a base class of an instantiated proxy. However, this is simply an internal detail of the C# mapping—conceptually, these methods belong with `Ice.ObjectPrx`, so we discuss them here.

The methods behave as follows:

- `ice_getIdentity`

This method returns the identity of the object denoted by the proxy. The identity of an Ice object has the following Slice type:

```

module Ice {
    struct Identity {
        string name;
        string category;
    };
};

```

To see whether two proxies denote the same object, first obtain the identity for each object and then compare the identities:

```

Ice.ObjectPrx o1 = ...;
Ice.ObjectPrx o2 = ...;
Ice.Identity i1 = o1.ice_getIdentity();
Ice.Identity i2 = o2.ice_getIdentity();

if (i1.Equals(i2))
    // o1 and o2 denote the same object
else
    // o1 and o2 denote different objects

```

- `ice_getHash`

This method returns a hash key for the proxy. (It is a synonym for `GetHashCode`.)

- `ice_isA`

This method determines whether the object denoted by the proxy supports a specific interface. The argument to `ice_isA` is a type ID (see Section 4.13). For example, to see whether a proxy of type `ObjectPrx` denotes a `Printer` object, we can write:

```
Ice.ObjectPrx o = ...;
if (o != null && o.ice_isA("::Printer"))
    // o denotes a Printer object
else
    // o denotes some other type of object
```

Note that we are testing whether the proxy is null before attempting to invoke the `ice_isA` method. This avoids getting a `NullReferenceException` if the proxy is null.

- `ice_id`

This method returns the type ID of the object denoted by the proxy. Note that the type returned is the type of the actual object, which may be more derived than the static type of the proxy. For example, if we have a proxy of type `BasePrx`, with a static type ID of `::Base`, the return value of `ice_id` might be `::Base`, or it might something more derived, such as `::Derived`.

- `ice_ping`

This method provides a basic reachability test for the object. If the object can physically be contacted (that is, the object exists and its server is running and reachable), the call completes normally; otherwise, it throws an exception that indicates why the object could not be reached, such as `ObjectNotExistException` or `ConnectTimeoutException`.

- `Equals`

This operation compares two proxies for equality. Note that all aspects of proxies are compared by this operation, such as the communication endpoints for the proxy. This means that, in general, if two proxies compare unequal, that does *not* imply that they denote different objects. For example, if two proxies denote the same Ice object via different transport endpoints, `equals` returns `false` even though the proxies denote the same object.

Note that there are other methods in `ObjectPrx`, not shown here. These methods provide different ways to dispatch a call and also provide access to an object's facets; we discuss these methods in Chapter 31 and XREF.

14.11.2 Proxy Helpers

For each Slice interface, apart from the proxy interface, the Slice-to-C# compiler creates a helper class: for an interface `Simple`, the name of the generated helper class is `SimplePrxHelper`.⁴ The helper class contains two methods of interest:

```
public class SimplePrxHelper : Ice.ObjectPrxHelperBase, SimplePrx
{
    public static SimplePrx checkedCast(Ice.ObjectPrx b);
    public static SimplePrx checkedCast(Ice.ObjectPrx b,
                                       Ice.Context ctx);
    public static SimplePrx uncheckedCast(Ice.ObjectPrx b)

    // ...
}
```

Both the `checkedCast` and `uncheckedCast` methods implement a down-cast: if the passed proxy is a proxy for an object of type `Simple`, or a proxy for an object with a type derived from `Simple`, the cast returns a non-null reference to a proxy of type `SimplePrx`; otherwise, if the passed proxy denotes an object of a different type (or if the passed proxy is null), the cast returns a null reference.

Given a proxy of any type, you can use a `checkedCast` to determine whether the corresponding object supports a given type, for example:

```
Ice.ObjectPrx obj = ...;           // Get a proxy from somewhere...

SimplePrx simple = SimplePrxHelper.checkedCast(obj);
if (simple != null)
    // Object supports the Simple interface...
else
    // Object is not of type Simple...
```

Note that a `checkedCast` contacts the server. This is necessary because only the implementation of an object in the server has definite knowledge of the type of an object. As a result, a `checkedCast` may throw a `ConnectTimeoutEx-`

4. You can ignore the `ObjectPrxHelperBase` base class—it exists for mapping-internal purposes.

ception or an `ObjectNotExistException`. (This also explains the need for the helper class: the Ice run time must contact the server, so we cannot use a C# down-cast.)

In contrast, an `uncheckedCast` does not contact the server and unconditionally returns a proxy of the requested type. However, if you do use an `uncheckedCast`, you must be certain that the proxy really does support the type you are casting to; otherwise, if you get it wrong, you will most likely get a run-time exception when you invoke an operation on the proxy. The most likely error for such a type mismatch is `OperationNotExistException`. However, other exceptions, such as a marshaling exception are possible as well. And, if the object happens to have an operation with the correct name, but different parameter types, no exception may be reported at all and you simply end up sending the invocation to an object of the wrong type; that object may do rather non-sensical things. To illustrate this, consider the following two interfaces:

```
interface Process {
    void launch(int stackSize, int dataSize);
};

// ...

interface Rocket {
    void launch(float xCoord, float yCoord);
};
```

Suppose you expect to receive a proxy for a `Process` object and use an `uncheckedCast` to down-cast the proxy:

```
Ice.ObjectPrx obj = ...; // Get proxy...
ProcessPrx process
    = ProcessPrxHelper.uncheckedCast(obj); // No worries...
process.launch(40, 60); // Oops...
```

If the proxy you received actually denotes a `Rocket` object, the error will go undetected by the Ice run time: because `int` and `float` have the same size and because the Ice protocol does not tag data with its type on the wire, the implementation of `Rocket::launch` will simply misinterpret the passed integers as floating-point numbers.

In fairness, this example is somewhat contrived. For such a mistake to go unnoticed at run time, both objects must have an operation with the same name and, in addition, the run-time arguments passed to the operation must have a total marshaled size that matches the number of bytes that are expected by the unmar-

shaling code on the server side. In practice, this is extremely rare and an incorrect `uncheckedCast` typically results in a run-time exception.

A final warning about down-casts: you must use either a `checkedCast` or an `uncheckedCast` to down-cast a proxy. If you use a C# cast, the behavior is undefined.

14.11.3 Object Identity and Proxy Comparison

As mentioned on page 420, proxies provide an `Equals` operation. Proxy comparison with `Equals` uses *all* of the information in a proxy for the comparison. This means that not only the object identity must match for a comparison to succeed, but other details inside the proxy, such as the protocol and endpoint information, must be the same. In other words, comparison with `Equals` (or `==` and `!=`) tests for *proxy* identity, *not* object identity. A common mistake is to write code along the following lines:

```
Ice.ObjectPrx p1 = ...;           // Get a proxy...
Ice.ObjectPrx p2 = ...;           // Get another proxy...

if (p1.Equals(p2)) {
    // p1 and p2 denote different objects           // WRONG!
} else {
    // p1 and p2 denote the same object             // Correct
}
```

Even though `p1` and `p2` differ, they may denote the same Ice object. This can happen because, for example, both `p1` and `p2` embed the same object identity, but each use a different protocol to contact the target object. Similarly, the protocols may be the same, but denote different endpoints (because a single Ice object can be contacted via several different transport endpoints). In other words, if two proxies compare equal with `Equals`, we know that the two proxies denote the same object (because they are identical in all respects); however, if two proxies compare unequal with `Equals`, we know absolutely nothing: the proxies may or may not denote the same object.

To compare the object identities of two proxies, you must use a helper function in the `Ice.Util` class:

```
public sealed class Util {
    public static int proxyIdentityCompare(ObjectPrx lhs,
                                         ObjectPrx rhs);
    public static int proxyIdentityAndFacetCompare(ObjectPrx lhs,
                                                  ObjectPrx rhs);
// ...

```

`proxyIdentityCompare` allows you to correctly compare proxies for identity:

```
Ice.ObjectPrx p1 = ...;           // Get a proxy...
Ice.ObjectPrx p2 = ...;           // Get another proxy...

if (Ice.Util.proxyIdentityCompare(p1, p2) != 0) {
    // p1 and p2 denote different objects      // Correct
} else {
    // p1 and p2 denote the same object        // Correct
}

```

The function returns 0 if the identities are equal, -1 if `p1` is less than `p2`, and 1 if `p1` is greater than `p2`. (The comparison uses name as the major and category as the minor sort key.)

The `proxyIdentityAndFacetCompare` performs the same function, but compares both the identity and the facet name (see Chapter 33).

The C# mapping also provides two helper classes in the `Ice` namespace that allow you to insert proxies into hashtables or ordered collections, based on the identity, or the identity plus the facet name:

```
public class ProxyIdentityKey
    : System.Collections.IHashCodeProvider,
      System.Collections.IComparer {

    public int GetHashCode(object obj);
    public int Compare(object obj1, object obj2);
}

public class ProxyIdentityFacetKey
    : System.Collections.IHashCodeProvider,
      System.Collections.IComparer {

    public int GetHashCode(object obj);
    public int Compare(object obj1, object obj2);
}

```

Note these classes derive from `IHashCodeProvider` and `IComparer`, so they can be used for both hash tables and ordered collections.

14.12 Mapping for Operations

As we saw in Section 14.11, for each operation on an interface, the proxy class contains a corresponding member function with the same name. To invoke an operation, you call it via the proxy. For example, here is part of the definitions for our file system from Section 5.4:

```
module Filesystem {
    interface Node {
        nonmutating string name();
    };
    // ...
};
```

The name operation returns a value of type `string`. Given a proxy to an object of type `Node`, the client can invoke the operation as follows:

```
NodePrx node = ...;           // Initialize proxy
string name = node.name();    // Get name via RPC
```

This illustrates the typical pattern for receiving return values: return values are returned by reference for complex types, and by value for simple types (such as `int` or `double`).

14.12.1 Normal, idempotent, and nonmutating Operations

You can add an `idempotent` or `nonmutating` qualifier to a Slice operation. As far as the signature for the corresponding proxy methods is concerned, neither `idempotent` nor `nonmutating` have any effect. For example, consider the following interface:

```
interface Example {
    string op1();
    idempotent string op2();
    nonmutating string op3();
};
```

The proxy interface for this is:

```
public interface ExamplePrx : Ice.ObjectPrx
{
    string op1();
    string op2();
    string op3();
}
```

idempotent and nonmutating affect an aspect of call dispatch, not interface, so it makes sense for the three methods to look the same.

14.12.2 Passing Parameters

In-Parameters

The parameter passing rules for the C# mapping are very simple: parameters are passed either by value (for value types) or by reference (for reference types). Semantically, the two ways of passing parameters are identical: it is guaranteed that the value of a parameter will not be changed by the invocation (with some caveats—see XREF).

Here is an interface with operations that pass parameters of various types from client to server:

```
struct NumberAndString {
    int x;
    string str;
};

sequence<string> StringSeq;

dictionary<long, StringSeq> StringTable;

interface ClientToServer {
    void op1(int i, float f, bool b, string s);
    void op2(NumberAndString ns, StringSeq ss, StringTable st);
    void op3(ClientToServer* proxy);
};
```

The Slice compiler generates the following proxy for this definition:

```
public interface ClientToServerPrx : Ice.ObjectPrx
{
    void op1(int i, float f, bool b, string s);
    void op2(NumberAndString ns, StringSeq ss, StringTable st);
    void op3(ClientToServerPrx proxy);
}
```

Given a proxy to a `ClientToServer` interface, the client code can pass parameters as in the following example:

```

ClientToServerPrx p = ...;           // Get proxy...

p.op1(42, 3.14f, true, "Hello world!"); // Pass simple literals

int i = 42;
float f = 3.14f;
bool b = true;
string s = "Hello world!";
p.op1(i, f, b, s);                   // Pass simple variables

NumberAndString ns = new NumberAndString();
ns.x = 42;
ns.str = "The Answer";
StringSS ss = new StringSS();
ss.Add("Hello world!");
StringTable st = new StringTable();
st[0] = ns;
p.op2(ns, ss, st);                   // Pass complex variables

p.op3(p);                             // Pass proxy

```

out-Parameters

Slice out parameters simply map to C# out parameters.

Here is the same Slice definition we saw on page 426 once more, but this time with all parameters being passed in the out direction:

```

struct NumberAndString {
    int x;
    string str;
};

sequence<string> StringSeq;

dictionary<long, StringSeq> StringTable;

interface ServerToClient {
    void op1(out int i, out float f, out bool b, out string s);
    void op2(out NumberAndString ns,
             out StringSeq ss,
             out StringTable st);
    void op3(out ServerToClient* proxy);
};

```

The Slice compiler generates the following code for this definition:

```
public interface ServerToClientPrx : Ice.ObjectPrx
{
    void op1(out int i, out float f, out bool b, out string s);
    void op2(out NumberAndString ns,
            out StringSeq ss,
            out StringTable st);
    void op3(out ServerToClientPrx proxy);
}
```

Given a proxy to a `ServerToClient` interface, the client code can pass parameters as in the following example:

```
ClientToServerPrx p = ...; // Get proxy...

int i;
float f;
bool b;
string s;
p.op1(out i, out f, out b, out s);

NumberAndString ns;
StringSeq ss;
StringTable st;
p.op2(out ns, out ss, out st);

ServerToClientPrx stc;
p.op3(out stc);

System.Console.WriteLine(i); // Show one of the values
```

Null Parameters

Some Slice types naturally have “empty” or “not there” semantics. Specifically, proxies, sequences (if mapped to `CollectionBase`), dictionaries, strings, and structures (if mapped to classes) can be null:

- For proxies, a C# null reference denotes the null proxy. The null proxy is a dedicated value that indicates that a proxy points “nowhere” (denotes no object).
- Sequences and dictionaries cannot be null, but can be empty. To make life with these types easier, whenever you pass a C# null reference as a parameter or return value of type sequence or dictionary, the Ice run time automatically sends an empty sequence or dictionary to the receiver.
- C# strings can be null, but Slice strings cannot (because Slice strings do not support the concept of a null string). Whenever you pass a C# null string as a

parameter or return value, the Ice run time automatically sends an empty string to the receiver.

- Structures can be null if you use the class mapping. If you pass a C# null reference to such a structure as a parameter or return value, the Ice run time automatically sends a structure whose elements are default initialized. This means that all proxy members are initialized to null, sequence and dictionary members are initialized to empty collections, strings are initialized to the empty string, and members that have a value type are initialized to their default values.

This behavior is useful as a convenience feature: especially for deeply-nested data types, members that are structures, sequences, dictionaries, or strings automatically arrive as an empty value at the receiving end. This saves you having to explicitly initialize, for example, every string element in a large sequence before sending it in order to avoid `NullReferenceExceptions`. Note that using null parameters in this way does *not* create null semantics for sequences, dictionaries, or strings. As far as the object model is concerned, these do not exist (only *empty* sequences, dictionaries, and strings do). For example, sending a string as a null reference or as an empty string makes no difference to the receiver: either way, the receiver sees an empty string.

14.13 Exception Handling

Any operation invocation may throw a run-time exception (see Section 14.10 on page 415) and, if the operation has an exception specification, may also throw user exceptions (see Section 14.10 on page 415). Suppose we have the following simple interface:

```
exception Tantrum {
    string reason;
};

interface Child {
    void askToCleanUp() throws Tantrum;
};
```

Slice exceptions are thrown as C# exceptions, so you can simply enclose one or more operation invocations in a `try-catch` block:

```
ChildPrx child = ...;    // Get child proxy...

try
{
    child.askToCleanUp();
}
catch (Tantrum t)
{
    System.Console.WriteLine("The child says: ");
    System.Console.WriteLine(t.reason);
}
```

Typically, you will catch only a few exceptions of specific interest around an operation invocation; other exceptions, such as unexpected run-time errors, will typically be handled by exception handlers higher in the hierarchy. For example:

```
public class Client
{
    private static void run() {
        ChildPrx child = ...;    // Get child proxy...
        try
        {
            child.askToCleanUp();
        }
        catch (Tantrum t)
        {
            System.Console.WriteLine("The child says: ");
            System.Console.WriteLine(t.reason);
            child.scold();        // Recover from error...
        }
        child.praise();          // Give positive feedback...
    }

    static void Main(string[] args)
    {
        try
        {
            // ...
            run();
            // ...
        }
        catch (Ice.Exception e)
        {
```

```
        System.Console.WriteLine(e);  
    }  
}
```

This code handles a specific exception of local interest at the point of call and deals with other exceptions generically. (This is also the strategy we used for our first simple application in Chapter 15.)

Note that the `ToString` method of exceptions prints the name of the exception, any inner exceptions, and the stack trace. Of course, you can be more selective in the way exceptions are displayed. For example, `e.Message` contains the error message (if any) for the exception, and `e.GetType().Name` returns the (unscoped) name of an exception.

Exceptions and out-Parameters

The Ice run time makes no guarantees about the state of out-parameters when an operation throws an exception: the parameter may still have its original value or may have been changed by the operation's implementation in the target object. In other words, for out-parameters, Ice provides the weak exception guarantee [21] but does not provide the strong exception guarantee.⁵

14.14 Mapping for Classes

Slice classes are mapped to C# classes with the same name. By default, the generated class contains a public data member for each Slice data member (just as for structures and exceptions), and a member function for each operation.

Note that classes also support the “`clr:property`” metadata directive, so you can generate classes with virtual properties instead of data members. (See page 402 for details on “`clr:property`”.)

Consider the following class definition:

5. This is done for reasons of efficiency: providing the strong exception guarantee would require more overhead than can be justified.

```

class TimeOfDay {
    short hour;           // 0 - 23
    short minute;        // 0 - 59
    short second;        // 0 - 59
    string format();     // Return time as hh:mm:ss
};

```

The Slice compiler generates the following code for this definition:

```

public interface TimeOfDayOperations_
{
    string format(Ice.Current __current);
}

public interface TimeOfDayOperationsNC_
{
    string format();
}

public abstract class TimeOfDay
: Ice.ObjectImpl,
  TimeOfDayOperations_,
  TimeOfDayOperationsNC_
{
    public short hour;
    public short minute;
    public short second;

    public TimeOfDay()
    {
    }

    public TimeOfDay(short hour, short minute, short second)
    {
        this.hour = hour;
        this.minute = minute;
        this.second = second;
    }

    public string format()
    {
        return format(new Ice.Current());
    }

    public abstract string format(Ice.Current __current);
}

```

There are a number of things to note about the generated code:

1. The compiler generates “operations interfaces” called `TimeOfDayOperations_` and `TimeOfDayOperationsNC_`. These interfaces contain a method for each Slice operation of the class.
2. The generated class `TimeOfDay` inherits (indirectly) from `Ice.Object`. This means that all classes implicitly inherit from `Ice.Object`, which is the ultimate ancestor of all classes. Note that `Ice.Object` is *not* the same as `Ice.ObjectPrx`. In other words, you *cannot* pass a class where a proxy is expected and vice versa.
If a class has only data members, but no operations, the compiler generates a non-abstract class.
3. The generated class contains a public member for each Slice data member.
4. The generated class inherits member functions for each Slice operation from the operations interfaces.
5. The generated class contains two constructors.

There is quite a bit to discuss here, so we will look at each item in turn.

14.14.1 Operations Interfaces

The methods in the `<interface-name>Operations_` interface have an additional trailing parameter of type `Ice.Current`, whereas the methods in the `<interface-name>OperationsNC_` interface lack this additional trailing parameter. The methods without the `Current` parameter simply forward to the methods with a `Current` parameter, supplying a default `Current`. For now, you can ignore this parameter and pretend it does not exist. (We look at it in more detail in Section 31.6.)

If a class has only data members, but no operations, the compiler omits generating the `<interface-name>Operations_` and `<interface-name>OperationsNC_` interfaces.

14.14.2 Inheritance from `Ice.Object`

Like interfaces, classes implicitly inherit from a common base class, `Ice.Object`. However, as shown in Figure 14.2, classes inherit from `Ice.Object` instead of `Ice.ObjectPrx` (which is at the base of the inheritance hierarchy for proxies). As a result, you cannot pass a class where a proxy is

expected (and vice versa) because the base types for classes and proxies are not compatible.

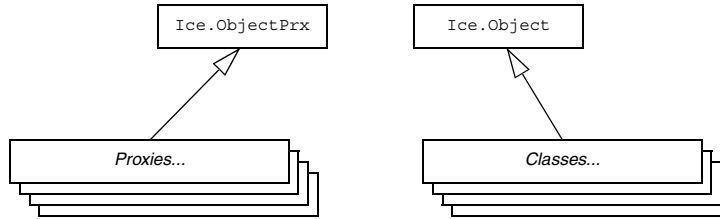

Figure 14.2. Inheritance from `Ice.ObjectPrx` and `Ice.Object`.

`Ice.Object` contains a number of member functions:

```

namespace Ice
{
    public interface Object : System.ICloneable
    {
        int ice_getHash();

        bool ice_isA(string s);
        bool ice_isA(string s, Current current);

        void ice_ping();
        void ice_ping(Current current);

        string[] ice_ids();
        string[] ice_ids(Current current);

        string ice_id();
        string ice_id(Current current);

        void ice_preMarshal();
        void ice_postUnmarshal();
    }
}
  
```

The member functions of `Ice.Object` behave as follows:

- `ice_getHash`

This function returns a hash value for the class, allowing you to easily place classes into hash tables. The implementation returns the value of `System.Object.GetHashCode`.

- `ice_isA`
This function returns `true` if the object supports the given type ID, and `false` otherwise.
- `ice_ping`
As for interfaces, `ice_ping` provides a basic reachability test for the class.
- `ice_ids`
This function returns a string sequence representing all of the type IDs supported by this object, including `::Ice::Object`.
- `ice_id`
This function returns the actual run-time type ID for a class. If you call `ice_id` through a reference to a base instance, the returned type id is the actual (possibly more derived) type ID of the instance.
- `ice_preMarshal`
The Ice run time invokes this function prior to marshaling the object's state, providing the opportunity for a subclass to validate its declared data members.
- `ice_postUnmarshal`
The Ice run time invokes this function after unmarshaling an object's state. A subclass typically overrides this function when it needs to perform additional initialization using the values of its declared data members.

Note that the generated class does *not* override `GetHashCode` and `Equals`. This means that classes are compared using shallow reference equality, not value equality (as is used for structures).

The class also provides a `Clone` method (whose implementation is inherited from `Ice.ObjectImpl`); the `Clone` method returns a shallow memberwise copy.

14.14.3 Data Members of Classes

Data members of classes are mapped exactly as for structures and exceptions: for each data member in the Slice definition, the generated class contains a corresponding public data member.

14.14.4 Operations of Classes

Operations of classes are mapped to abstract member functions in the generated class. This means that, if a class contains operations (such as the `format` operation

of our `TimeOfDay` class), you must provide an implementation of the operation in a class that is derived from the generated class. For example:

```
public class TimeOfDayI : TimeOfDay
{
    public string format(Ice.Current current)
    {
        return    hour.ToString("D2") + ":"
                + minute.ToString("D2") + ":"
                + second.ToString("D2");
    }
}
```

Class Factories

Having created a class such as `TimeOfDayI`, we have an implementation and we can instantiate the `TimeOfDayI` class, but we cannot receive it as the return value or as an out-parameter from an operation invocation. To see why, consider the following simple interface:

```
interface Time {
    TimeOfDay get();
};
```

When a client invokes the `get` operation, the Ice run time must instantiate and return an instance of the `TimeOfDay` class. However, `TimeOfDay` is an abstract class that cannot be instantiated. Unless we tell it, the Ice run time cannot magically know that we have created a `TimeOfDayI` class that implements the abstract `format` operation of the `TimeOfDay` abstract class. In other words, we must provide the Ice run time with a factory that knows that the `TimeOfDay` abstract class has a `TimeOfDayI` concrete implementation. The `Ice::Communicator` interface provides us with the necessary operations:

```
module Ice {
    local interface ObjectFactory {
        Object create(string type);
        void destroy();
    };

    local interface Communicator {
        void addObjectFactory(ObjectFactory factory, string id);
        ObjectFactory findObjectFactory(string id);
        // ...
    };
};
```

To supply the Ice run time with a factory for our `TimeOfDayI` class, we must implement the `ObjectFactory` interface:

```
class ObjectFactory : Ice.LocalObjectImpl, Ice.ObjectFactory
{
    public Ice.Object create(string type)
    {
        if (type.Equals("::M::TimeOfDay"))
            return new TimeOfDayI();
        System.Diagnostics.Debug.Assert(false);
        return null;
    }

    public void destroy()
    {
        // Nothing to do
    }
}
```

The object factory's `create` method is called by the Ice run time when it needs to instantiate a `TimeOfDay` class. The factory's `destroy` method is called by the Ice run time when its communicator is destroyed.

The `create` method is passed the type ID (see Section 4.13) of the class to instantiate. For our `TimeOfDay` class, the type ID is `::M::TimeOfDay`. Our implementation of `create` checks the type ID: if it is `::M::TimeOfDay`, it instantiates and returns a `TimeOfDayI` object. For other type IDs, it asserts because it does not know how to instantiate other types of objects.

Given a factory implementation, such as our `ObjectFactory`, we must inform the Ice run time of the existence of the factory:

```
Ice.Communicator ic = ...;
ic.addObjectFactory(new ObjectFactory(), "::M::TimeOfDay");
```

Now, whenever the Ice run time needs to instantiate a class with the type ID `::M::TimeOfDay`, it calls the `create` method of the registered `ObjectFactory` instance, which returns a `TimeOfDayI` instance to the Ice run time.

The `destroy` operation of the object factory is invoked by the Ice run time when the communicator is destroyed. This gives you a chance to clean up any resources that may be used by your factory. Do not call `destroy` on the factory while it is registered with the communicator—if you do, the Ice run time has no idea that this has happened and, depending on what your `destroy` implementation is doing, may cause undefined behavior when the Ice run time tries to next use the factory.

The run time guarantees that `destroy` will be the last call made on the factory, that is, `create` will not be called concurrently with `destroy`, and `create` will not be called once `destroy` has been called. However, calls to `create` can be made concurrently.

Note that you cannot register a factory for the same type ID twice: if you call `addObjectFactory` with a type ID for which a factory is registered, the Ice run time throws an `AlreadyRegisteredException`.

Finally, keep in mind that if a class has only data members, but no operations, you need not create and register an object factory to transmit instances of such a class. Only if a class has operations do you have to define and register an object factory.

Inheritance from `LocalObject`

Note that the implementation of the factory in the previous example extends `Ice.LocalObjectImpl`. The object factory, being a local object, inherits a number of operations from `Ice.LocalObject`, such as `ice_getHash` (see page 420). The `Ice.LocalObjectImpl` class provides implementations for these operations, so you do not need to implement them yourself.

In general, all local interfaces inherit from `Ice.LocalObject`, and all implementations of local interfaces, such as an object factory or servant locator (see Section 31.7) must inherit from `Ice.LocalObjectImpl`.

14.14.5 Class Constructors

The generated class contains both a default constructor, and a constructor that accepts one argument for each member of the class. This allows you to create and initialize a class in a single statement, for example:

```
TimeOfDayI tod = new TimeOfDayI(14, 45, 00); // 2:45pm
```

For derived classes, the constructor requires one argument of all of the members of the class, including members of the base class(es). For example, consider the the definition from Section 4.11.2 once more:

```
class TimeOfDay {
    short hour;           // 0 - 23
    short minute;        // 0 - 59
    short second;        // 0 - 59
};

class DateTime extends TimeOfDay {
```

```
    short day;           // 1 - 31
    short month;        // 1 - 12
    short year;         // 1753 onwards
};
```

The constructors for the generated classes are as follows:

```
public class TimeOfDay : Ice.ObjectImpl
{
    public TimeOfDay() {}

    public TimeOfDay(short hour, short minute, short second)
    {
        this.hour = hour;
        this.minute = minute;
        this.second = second;
    }

    // ...
}

public class DateTime : TimeOfDay
{
    public DateTime() : base() {}

    public DateTime(short hour,
                    short minute,
                    short second,
                    short day,
                    short month,
                    short year) : base(hour, minute, second)
    {
        this.day = day;
        this.month = month;
        this.year = year;
    }

    // ...
}
```

In other words, if you want to instantiate and initialize a `DateTime` instance, you must either use the default constructor or provide data for all of the data members of the instance, including data members of any base classes.

14.15 C#-Specific Metadata Directives

The `slice2cs` compiler supports metadata directives that allow you inject C# attribute specifications into the generated code. The metadata directive is `cs:attribute:.` For example:

```
["cs:attribute:System.Serializable"]
struct Point {
    double x;
    double y;
};
```

This results in the following code being generated for S:

```
[System.Serializable]
public struct Point
{
    public double x;
    public double y;
    // ...
}
```

You can apply this metadata directive to any slice construct, such as structure, operation, or parameter definitions.

You can use this directive also at global level. For example:

```
["cs:attribute:assembly: AssemblyDescription(\"My assembly\")"]
```

This results in the following code being inserted following any using directives and preceding any definitions:

```
[assembly: AssemblyDescription("My assembly")]
```

14.16 `slice2cs` Command-Line Options

The Slice-to-C# compiler, `slice2cs`, offers the following command-line options in addition to the standard options described in Section 4.19:

- `--tie`
Generate tie classes (see Section 16.7).
- `--impl`
Generate sample implementation files. This option will not overwrite an existing file.

- **--impl-tie**
Generate sample implementation files using ties (see Section 16.7). This option will not overwrite an existing file.
- **--checksum**
Generate checksums for Slice definitions.
- **--stream**
Generate streaming helper functions for Slice types (see Section 36.2).

14.17 Using Slice Checksums

As described in Section 4.20, the Slice compilers can optionally generate checksums of Slice definitions. For `slice2cs`, the `--checksum` option causes the compiler to generate checksums in each C# source file that are added to a member of the `Ice.SliceChecksums` class:

```
namespace Ice {  
    public sealed class SliceChecksums {  
        public readonly static SliceChecksumDict checksums;  
    };  
}
```

The `checksums` map is initialized automatically prior to first use; no action is required by the application.

In order to verify a server's checksums, a client could simply compare the dictionaries using the `Equals` function. However, this is not feasible if it is possible that the server might be linked with more Slice definitions than the client. A more general solution is to iterate over the local checksums as demonstrated below:

```
Ice.SliceChecksumDict serverChecksums = ...  
foreach(System.Collections.DictionaryEntry e  
    in Ice.SliceChecksums.checksums) {  
    string checksum = serverChecksums[e.Key];  
    if(checksum == null) {  
        // No match found for type id!  
    } else if(!checksum.Equals(e.Value)) {  
        // Checksum mismatch!  
    }  
}
```

In this example, the client first verifies that the server's dictionary contains an entry for each Slice type ID, and then it proceeds to compare the checksums.

Chapter 15

Developing a File System Client in C#

15.1 Chapter Overview

In this chapter, we present the source code for a C# client that accesses the file system we developed in Chapter 5 (see Chapter 17 for the corresponding server).

15.2 The C# Client

We now have seen enough of the client-side C# mapping to develop a complete client to access our remote file system. For reference, here is the Slice definition once more:

```
module Filesystem {
    interface Node {
        nonmutating string name();
    };

    exception GenericError {
        string reason;
    };

    sequence<string> Lines;

    interface File extends Node {
```

```

        nonmutating Lines read();
        idempotent void write(Lines text) throws GenericError;
};

sequence<Node*> NodeSeq;

interface Directory extends Node {
    nonmutating NodeSeq list();
};

interface Filesys {
    nonmutating Directory* getRoot();
};
};

```

To exercise the file system, the client does a recursive listing of the file system, starting at the root directory. For each node in the file system, the client shows the name of the node and whether that node is a file or directory. If the node is a file, the client retrieves the contents of the file and prints them.

The body of the client code looks as follows:

```

using System;
using Filesystem;

public class Client
{
    // Recursively print the contents of directory "dir"
    // in tree fashion. For files, show the contents of
    // each file. The "depth" parameter is the current
    // nesting level (for indentation).

    static void listRecursive(DirectoryPrx dir, int depth)
    {
        string indent = new string('\t', ++depth);

        NodePrx[] contents = dir.list();

        foreach (NodePrx node in contents)
            DirectoryPrx subdir
                = DirectoryPrxHelper.checkedCast(node);
            FilePrx file = FilePrxHelper.uncheckedCast(node);
            Console.WriteLine(indent + node.name() +
                (subdir != null ? " (directory):" : " (file):"));
            if (subdir != null) {
                listRecursive(subdir, depth);
            }
        }
    }
}

```

```
        } else {
            string[] text = file.read();
            for (int j = 0; j < text.Length; ++j)
                Console.WriteLine(indent + "\t" + text[j]);
        }
    }
}

public static void Main(string[] args)
{
    int status = 0;
    Ice.Communicator ic = null;
    try {
        // Create a communicator
        //
        ic = Ice.Util.initialize(ref args);

        // Create a proxy for the root directory
        //
        Ice.ObjectPrx obj
            = ic.stringToProxy("RootDir:default -p 10000");

        // Down-cast the proxy to a Directory proxy
        //
        DirectoryPrx rootDir
            = DirectoryPrxHelper.checkedCast(obj);

        // Recursively list the contents of the root directory
        //
        Console.WriteLine("Contents of root directory:");
        listRecursive(rootDir, 0);
    } catch (Exception e) {
        Console.Error.WriteLine(e);
        status = 1;
    }
    if (ic != null) {
        // Clean up
        //
        try {
            ic.destroy();
        } catch (Exception e) {
            Console.Error.WriteLine(e);
            status = 1;
        }
    }
}
```

```
        }
        Environment.Exit(status);
    }
}
```

The `Client` class defines two methods: `listRecursive`, which is a helper function to print the contents of the file system, and `Main`, which is the main program. Let us look at `Main` first:

1. The structure of the code in `Main` follows what we saw in Chapter 3. After initializing the run time, the client creates a proxy to the root directory of the file system. For this example, we assume that the server runs on the local host and listens using the default protocol (TCP/IP) at port 10000. The object identity of the root directory is known to be `RootDir`.
2. The client down-casts the proxy to `DirectoryPrx` and passes that proxy to `listRecursive`, which prints the contents of the file system.

Most of the work happens in `listRecursive`. The function is passed a proxy to a directory to list, and an indent level. (The indent level increments with each recursive call and allows the code to print the name of each node at an indent level that corresponds to the depth of the tree at that node.) `listRecursive` calls the `list` operation on the directory and iterates over the returned sequence of nodes:

1. The code does a `checkedCast` to narrow the `Node` proxy to a `Directory` proxy, as well as an `uncheckedCast` to narrow the `Node` proxy to a `File` proxy. Exactly one of those casts will succeed, so there is no need to call `checkedCast` twice: if the `Node` *is-a* `Directory`, the code uses the `DirectoryPrx` returned by the `checkedCast`; if the `checkedCast` fails, we *know* that the `Node` *is-a* `File` and, therefore, an `uncheckedCast` is sufficient to get a `FilePrx`.

In general, if you know that a down-cast to a specific type will succeed, it is preferable to use an `uncheckedCast` instead of a `checkedCast` because an `uncheckedCast` does not incur any network traffic.

2. The code prints the name of the file or directory and then, depending on which cast succeeded, prints "`(directory)`" or "`(file)`" following the name.
3. The code checks the type of the node:
 - If it is a directory, the code recurses, incrementing the indent level.
 - If it is a file, the code calls the `read` operation on the file to retrieve the file contents and then iterates over the returned sequence of lines, printing each line.

Assume that we have a small file system consisting of two files and a directory as follows:

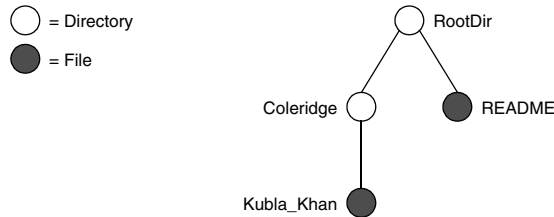

Figure 15.1. A small file system.

The output produced by client for this file system is:

Contents of root directory:

README (file):

This file system contains a collection of poetry.

Coleridge (directory):

Kubla_Khan (file):

In Xanadu did Kubla Khan
 A stately pleasure-dome decree:
 Where Alph, the sacred river, ran
 Through caverns measureless to man
 Down to a sunless sea.

Note that, so far, our client (and server) are not very sophisticated:

- The protocol and address information are hard-wired into the code.
- The client makes more remote procedure calls than strictly necessary; with minor redesign of the Slice definitions, many of these calls can be avoided.

We will see how to address these shortcomings in Chapter 37 and XREF.

15.3 Summary

This chapter presented a very simple client to access a server that implements the file system we developed in Chapter 5. As you can see, the C# code hardly differs from the code you would write for an ordinary C# program. This is one of the biggest advantages of using Ice: accessing a remote object is as easy as accessing an ordinary, local C# object. This allows you to put your effort where you should, namely, into developing your application logic instead of having to struggle with

arcane networking APIs. As we will see in Chapter 17, this is true for the server side as well, meaning that you can develop distributed applications easily and efficiently.

Chapter 16

Server-Side Slice-to-C# Mapping

16.1 Chapter Overview

In this chapter, we present the server-side Slice-to-C# mapping (see Chapter 14 for the client-side mapping). Section 16.3 discusses how to initialize and finalize the server-side run time, sections 16.4 to 16.7 show how to implement interfaces and operations, and Section 16.8 discusses how to register objects with the server-side Ice run time.

16.2 Introduction

The mapping for Slice data types to C# is identical on the client side and server side. This means that everything in Chapter 14 also applies to the server side. However, for the server side, there are a few additional things you need to know, specifically:

- how to initialize and finalize the server-side run time
- how to implement servants
- how to pass parameters and throw exceptions
- how to create servants and register them with the Ice run time.

We discuss these topics in the remainder of this chapter.

16.3 The Server-Side Main Method

The main entry point to the Ice run time is represented by the local interface `Ice::Communicator`. As for the client side, you must initialize the Ice run time by calling `Ice.Util.initialize` before you can do anything else in your server. `Ice.Util.initialize` returns a reference to an instance of an `Ice.Communicator`:

```
using System;

public class Server
{
    public static void Main(string[] args)
    {
        int status = 0;
        Ice.Communicator communicator = null;

        try {
            communicator = Ice.Util.initialize(ref args);
            // ...
        } catch (Exception ex) {
            Console.Error.WriteLine(ex);
            status = 1;
        }
        // ...
    }
}
```

`Ice.Util.initialize` accepts the argument vector that is passed to `Main` by the operating system. The method scans the argument vector for any command-line options that are relevant to the Ice run time; any such options are removed from the argument vector so, when `Ice.Util.initialize` returns, the only options and arguments remaining are those that concern your application. If anything goes wrong during initialization, `initialize` throws an exception.

Before leaving your `Main` method, you *must* call `Communicator::destroy`. The `destroy` operation is responsible for finalizing the Ice run time. In particular, `destroy` waits for any operation invocations that may still be running to complete. In addition, `destroy` ensures that any outstanding threads are joined with and reclaims a number of operating system resources, such as file descriptors and memory. Never allow your `Main` method to terminate without calling `destroy` first; doing so has undefined behavior.

The general shape of our server-side `Main` method is therefore as follows:

```
using System;

public class Server
{
    public static void Main(string[] args)
    {
        int status = 0;
        Ice.Communicator communicator = null;

        try {
            communicator = Ice.Util.initialize(ref args);
            // ...
        } catch (Exception ex) {
            Console.Error.WriteLine(ex);
            status = 1;
        }

        if (communicator != null) {
            try {
                communicator.destroy();
            } catch (Exception ex) {
                Console.Error.WriteLine(ex);
                status = 1;
            }
        }

        Environment.Exit(status);
    }
}
```

Note that the code places the call to `Ice.Util.initialize` into a `try` block and takes care to return the correct exit status to the operating system. Also note that an attempt to destroy the communicator is made only if the initialization succeeded.

16.3.1 The `Ice.Application` Class

The preceding structure for the `Main` method is so common that `Ice` offers a class, `Ice.Application`, that encapsulates all the correct initialization and finalization activities. The synopsis of the class is as follows (with some detail omitted for now):

```
namespace Ice
{
    public abstract class Application
    {
        public abstract int run(string[] args);
    }
}
```

```

        public Application();

        public int main(string[] args);
        public int main(string[] args, string configFile);

        public static string appName();

        public static Communicator communicator();
    }
}

```

The intent of this class is that you specialize `Ice.Application` and implement the abstract `run` method in your derived class. Whatever code you would normally place in `Main` goes into the `run` method instead. Using `Ice.Application`, our program looks as follows:

```

using System;

public class Server : Ice.Application
{
    public override int run(string[] args)
    {
        // Server code here...

        return 0;
    }

    public static void Main(string[] args)
    {
        Server app = new Server();
        Environment.Exit(app.main(args));
    }
}

```

The `Application.main` method does the following:

1. It installs an exception handler for `System.Exception`. If your code fails to handle an exception, `Application.main` prints the name of the exception and a stack trace on `Console.Error` before returning with a non-zero return value.
2. It initializes (by calling `Ice.Util.initialize`) and finalizes (by calling `Communicator.destroy`) a communicator. You can get access to the communicator for your server by calling the static `communicator` accessor.

3. It scans the argument vector for options that are relevant to the Ice run time and removes any such options. The argument vector that is passed to your run method therefore is free of Ice-related options and only contains options and arguments that are specific to your application.
4. It provides the name of your application via the static `appName` method. You can get at the application name from anywhere in your code by calling `Ice.Application.appName` (which is usually required for error messages).
5. It creates an `IceUtil.CtrlCHandler` that properly destroys the communicator.

Using `Ice.Application` ensures that your program properly finalizes the Ice run time, whether your server terminates normally or in response to an exception. We recommend that all your programs use this class; doing so makes your life easier. In addition `Ice.Application` also provides features for signal handling and configuration that you do not have to implement yourself when you use this class.

Using `Ice.Application` on the Client Side

You can use `Ice.Application` for your clients as well: simply implement a class that derives from `Ice.Application` and place the client code into its run method. The advantage of this approach is the same as for the server side: `Ice.Application` ensures that the communicator is destroyed correctly even in the presence of exceptions.

Catching Signals

The simple server we developed in Chapter 3 had no way to shut down cleanly: we simply interrupted the server from the command line to force it to exit. Terminating a server in this fashion is unacceptable for many real-life server applications: typically, the server has to perform some cleanup work before terminating, such as flushing database buffers or closing network connections. This is particularly important on receipt of a signal or keyboard interrupt to prevent possible corruption of database files or other persistent data.

To make it easier to deal with signals, `Ice.Application` encapsulates the platform-independent signal handling capabilities provided by the class `IceUtil.CtrlCHandler` (see Section 30.11). This allows you to cleanly shut down on receipt of a signal and to use the same source code regardless of the underlying operating system and C# run time:

```
namespace Ice
{
    public abstract class Application
    {
        // ...

        public static void destroyOnInterrupt();
        public static void shutdownOnInterrupt();
        public static void ignoreInterrupt();
        public static void holdInterrupt();
        public static void releaseInterrupt();

        public static bool interrupted();
    }
}
```

The methods behave as follows:

- `destroyOnInterrupt`
This method installs a handler that destroys the communicator if it is interrupted. This is the default behavior.
- `shutdownOnInterrupt`
This method installs a handler that shuts down the communicator if it is interrupted.
- `ignoreInterrupt`
This method causes signals to be ignored.
- `holdInterrupt`
This method temporarily blocks signal delivery.
- `releaseInterrupt`
This method restores signal delivery to the previous disposition. Any signal that arrives after `holdInterrupt` was called is delivered when you call `releaseInterrupt`.
- `interrupted`
This method returns `true` if a signal caused the communicator to shut down, `false` otherwise. This allows us to distinguish intentional shutdown from a forced shutdown that was caused by a signal. This is useful, for example, for logging purposes.

By default, `Ice.Application` behaves as if `destroyOnInterrupt` was invoked, therefore our server `Main` method requires no change to ensure that the

program terminates cleanly on receipt of a signal. However, we add a diagnostic to report the occurrence, so our run method now looks like:

```
using System;

public class Server : Ice.Application
{
    public override int run(string[] args)
    {
        // Server code here...

        if (interrupted())
            Console.Error.WriteLine(appName() + ": terminating");

        return 0;
    }

    public static void Main(string[] args)
    {
        Server app = new Server();
        Environment.Exit(app.main(args));
    }
}
```

Ice.Application and Properties

Apart from the functionality shown in this section, `Ice.Application` also takes care of initializing the Ice run time with property values. Properties allow you to configure the run time in various ways. For example, you can use properties to control things such as the thread pool size or port number for a server. The main method of `Ice.Application` is overloaded; the second version allows you to specify the name of a configuration file that will be processed during initialization. We discuss Ice properties in more detail in Chapter 30.

Limitations of Ice.Application

`Ice.Application` is a singleton class that creates a single communicator. If you are using multiple communicators, you cannot use `Ice.Application`. Instead, you must structure your code as we saw in Chapter 3 (taking care to always destroy the communicator).

16.4 Mapping for Interfaces

The server-side mapping for interfaces provides an up-call API for the Ice run time: by implementing methods in a servant class, you provide the hook that gets the thread of control from the Ice server-side run time into your application code.

16.4.1 Skeleton Classes

On the client side, interfaces map to proxy classes (see Section 5.12). On the server side, interfaces map to *skeleton* classes. A skeleton is a class that has an abstract method for each operation on the corresponding interface. For example, consider the Slice definition for the `Node` interface we defined in Chapter 5 once more:

```
module Filesystem {
    interface Node {
        nonmutating string name();
    };
    // ...
};
```

The Slice compiler generates the following definition for this interface:

```
namespace Filesystem
{
    public interface NodeOperations_
    {
        string name(Ice.Current __current);
    }

    public interface NodeOperationsNC_
    {
        string name();
    }

    public interface Node : Ice.Object,
                          NodeOperations_, NodeOperationsNC_
    {
    }

    public abstract class NodeDisp_ : Ice.ObjectImpl, Node
    {
        public string name()
        {
```

```

        return name(new Ice.Current());
    }

    public abstract string name(Ice.Current __current);

    // Mapping-internal code here...
}
}

```

The important points to note here are:

- As for the client side, Slice modules are mapped to C# namespaces with the same name, so the skeleton class definitions are part of the `Filesystem` namespace.
- For each Slice interface `<interface-name>`, the compiler generates C# interfaces `<interface-name>Operations_` and `<interface-name>OperationsNC_` (`NodeOperations_` and `NodeOperationsNC_` in this example). These interfaces contain a method for each operation in the Slice interface. (You can ignore the `Ice.Current` parameter for the time being—we discuss it in detail in Section 31.6.)
- For each Slice interface `<interface-name>`, the compiler generates a C# interface `<interface-name>` (`Node` in this example). That interface extends `Ice.Object` and the two operations interfaces.
- For each Slice interface `<interface-name>`, the compiler generates an abstract class `<interface-name>Disp_` (`NodeDisp_` in this example). This abstract class is the actual skeleton class; it is the base class from which you derive your servant class.

16.4.2 Servant Classes

In order to provide an implementation for an Ice object, you must create a servant class that inherits from the corresponding skeleton class. For example, to create a servant for the `Node` interface, you could write:

```

public class NodeI : NodeDisp_
{
    public NodeI(string name)
    {
        _name = name;
    }

    public override string name(Ice.Current current)

```

```

    {
        return _name;
    }

    private string _name;
}

```

By convention, servant classes have the name of their interface with an I-suffix, so the servant class for the `Node` interface is called `NodeI`. (This is a convention only: as far as the Ice run time is concerned, you can choose any name you prefer for your servant classes.) Note that `NodeI` extends `NodeDisp_`, that is, it derives from its skeleton class.

As far as Ice is concerned, the `NodeI` class must implement only a single method: the abstract `name` method that it inherits from its skeleton. This makes the servant class a concrete class that can be instantiated. You can add other methods and data members as you see fit to support your implementation. For example, in the preceding definition, we added a `_name` member and a constructor. (Obviously, the constructor initializes the `_name` member and the `name` method returns its value.)

Normal, idempotent, and nonmutating Operations

Whether an operation is an ordinary operation, or an `idempotent` or `nonmutating` operation has no influence on the way the operation is mapped. To illustrate this, consider the following interface:

```

interface Example {
    void normalOp();
    idempotent void idempotentOp();
    nonmutating void nonmutatingOp();
};

```

The operations class for this interface looks like this:

```

public interface ExampleOperations_
{
    void normalOp(Ice.Current __current);
    void idempotentOp(Ice.Current __current);
    void nonmutatingOp(Ice.Current __current);
}

```

Note that the signatures of the methods are unaffected by the `idempotent` and `nonmutating` qualifiers because C# has no notion of const-correctness (whereas, in C++, the `nonmutating` qualifier generates a C++ `const` member function).

16.5 Parameter Passing

For each parameter of a Slice operation, the C# mapping generates a corresponding parameter for the corresponding method in the `<interface-name>Operations_` interface. In addition, every operation has an additional, trailing parameter of type `Ice.Current`. For example, the `name` operation of the `Node` interface has no parameters, but the `name` method of the `NodeOperations_` interface has a single parameter of type `Ice.Current`. We explain the purpose of this parameter in Section 31.6 and will ignore it for now.

To illustrate the rules, consider the following interface that passes string parameters in all possible directions:

```
module M {
    interface Example {
        string op(string sin, out string sout);
    };
};
```

The generated method for `op` looks as follows:

```
public interface ExampleOperations_
{
    string op(string sin, out string sout, Ice.Current __current);
}
```

As you can see, there are no surprises here. For example, we could implement `op` as follows:

```
using System;

public class ExampleI : ExampleDisp_
{
    public override string op(string sin, out string sout,
        Ice.Current current)
    {
        Console.WriteLine(sin); // In params are initialized
        sout = "Hello World!"; // Assign out param
        return "Done";
    }
}
```

This code is in no way different from what you would normally write if you were to pass strings to and from a method; the fact that remote procedure calls are involved does not affect your code in any way. The same is true for parameters of

other types, such as proxies, classes, or dictionaries: the parameter passing conventions follow normal C# rules and do not require special-purpose API calls.

16.6 Raising Exceptions

To throw an exception from an operation implementation, you simply instantiate the exception, initialize it, and throw it. For example:

```
// ...
public override void write(string[] text, Ice.Current current)
{
    try
    {
        // Try to write file contents here...
    }
    catch(System.Exception ex)
    {
        GenericError e = new GenericError("cannot write file", ex)
;
        e.reason = "Exception during write operation";
        throw e;
    }
}
```

Note that, for this example, we have supplied the optional second parameter to the `GenericError` constructor (see Section 14.10). This parameter sets the `InnerException` member of `System.Exception` and preserves the original cause of the error for later diagnosis.

```
// ...

public void
write(String[] text, Ice.Current current)
    throws GenericError

{
    // Try to write file contents here...
    // Assume we are out of space...
    if (error) {
        GenericError e = new GenericError();
        e.reason = "file too large";
        throw e;
    }
}
```

If you throw an arbitrary C# run-time exception (such as an `InvalidCastException`), the Ice run time catches the exception and then returns an `UnknownException` to the client. Similarly, if you throw an “impossible” user exception (a user exception that is not listed in the exception specification of the operation), the client receives an `UnknownUserException`.

If you throw an Ice run-time exception, such `MemoryLimitException`, the client receives an `UnknownLocalException`.¹ For that reason, you should never throw system exceptions from operation implementations. If you do, all the client will see is an `UnknownLocalException`, which does not tell the client anything useful.

16.7 Tie Classes

The mapping to skeleton classes we saw in Section 16.4 requires the servant class to inherit from its skeleton class. Occasionally, this creates a problem: some class libraries require you to inherit from a base class in order to access functionality provided by the library; because C# does not support multiple implementation inheritance, this means that you cannot use such a class library to implement your servants because your servants cannot inherit from both the library class and the skeleton class simultaneously.

To allow you to still use such class libraries, Ice provides a way to write servants that replaces inheritance with delegation. This approach is supported by *tie classes*. The idea is that, instead of inheriting from the skeleton class, you simply create a class (known as an *implementation class* or *delegate class*) that contains methods corresponding to the operations of an interface. You use the `--tie` option with the `slice2cs` compiler to create a tie class. For example, for the `Node` interface we saw in Section 16.4.1, the `--tie` option causes the compiler to create exactly the same code as we saw previously, but to also emit an additional tie class. For an interface `<interface-name>`, the generated tie class has the name `<interface-name>Tie_:`

1. There are three run-time exceptions that are not changed to `UnknownLocalException` when returned to the client: `ObjectNotExistException`, `OperationNotExistException`, and `FacetNotExistException`. We discuss these exceptions in more detail in Chapter 33.

```
public class NodeTie_ : NodeDisp_, Ice.TieBase
{
    public NodeTie_()
    {
    }

    public NodeTie_(NodeOperations_ del)
    {
        _ice_delegate = del;
    }

    public object ice_delegate()
    {
        return _ice_delegate;
    }

    public void ice_delegate(object del)
    {
        _ice_delegate = (NodeOperations_)del;
    }

    public override int ice_getHash()
    {
        return GetHashCode();
    }

    public override int GetHashCode()
    {
        return _ice_delegate == null
            ? 0
            : _ice_delegate.GetHashCode();
    }

    public override bool Equals(object rhs)
    {
        if(object.ReferenceEquals(this, rhs))
        {
            return true;
        }
        if(!(rhs is NodeTie_))
        {
            return false;
        }
        if(_ice_delegate == null)
        {
            return ((NodeTie_)rhs)._ice_delegate == null;
        }
    }
}
```

```

    }
    return _ice_delegate.Equals(((NodeTie_) rhs)._ice_delegate);
}

public override string name(Ice.Current __current)
{
    return _ice_delegate.name(__current);
}

private NodeOperations_ _ice_delegate;
}

```

This looks a lot worse than it is: in essence, the generated tie class is simply a servant class (it extends `NodeDisp_`) that delegates each invocation of a method that corresponds to a Slice operation to your implementation class (see Figure 16.1).

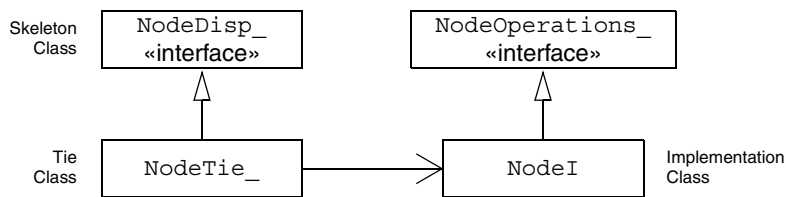

Figure 16.1. A skeleton class, tie class, and implementation class.

The `Ice.TieBase` interface defines the `ice_delegate` methods that allow you to get and set the delegate.

Given this machinery, we can create an implementation class for our `Node` interface as follows:

```

public class NodeI : NodeOperations_
{
    public NodeI(string name)
    {
        _name = name;
    }

    public override string name(Ice.Current current)
    {
        return _name;
    }
}

```

```

    }

    private string _name;
}

```

Note that this class is identical to our previous implementation, except that it implements the `NodeOperations_` interface and does not extend `NodeDisp_` (which means that you are now free to extend any other class to support your implementation).

To create a servant, you instantiate your implementation class and the tie class, passing a reference to the implementation instance to the tie constructor:

```

NodeI fred = new NodeI("Fred");           // Create implementation
NodeTie_ servant = new NodeTie_(fred);    // Create tie

```

Alternatively, you can also default-construct the tie class and later set its delegate instance by calling `ice_delegate`:

```

NodeTie_ servant = new NodeTie_();        // Create tie
// ...
NodeI fred = new NodeI("Fred");          // Create implementation
// ...
servant.ice_delegate(fred);              // Set delegate

```

When using tie classes, it is important to remember that the tie instance is the servant, not your delegate. Furthermore, you must not use a tie instance to incarnate (see Section 16.8) an Ice object until the tie has a delegate. Once you have set the delegate, you must not change it for the lifetime of the tie; otherwise, undefined behavior results.

You should use the tie approach only if you need to, that is, if you need to extend some base class in order to implement your servants: using the tie approach is more costly in terms of memory because each Ice object is incarnated by two C# objects instead of one, the tie and the delegate. In addition, call dispatch for ties is marginally slower than for ordinary servants because the tie forwards each operation to the delegate, that is, each operation invocation requires two function calls instead of one.

Also note that, unless you arrange for it, there is no way to get from the delegate back to the tie. If you need to navigate back to the tie from the delegate, you can store a reference to the tie in a member of the delegate. (The reference can, for example, be initialized by the constructor of the delegate.)

16.8 Object Incarnation

Having created a servant class such as the rudimentary `NodeI` class in Section 16.4.2, you can instantiate the class to create a concrete servant that can receive invocations from a client. However, merely instantiating a servant class is insufficient to incarnate an object. Specifically, to provide an implementation of an Ice object, you must take the following steps:

1. Instantiate a servant class.
2. Create an identity for the Ice object incarnated by the servant.
3. Inform the Ice run time of the existence of the servant.
4. Pass a proxy for the object to a client so the client can reach it.

16.8.1 Instantiating a Servant

Instantiating a servant means to allocate an instance:

```
Node servant = new NodeI("Fred");
```

This code creates a new `NodeI` instance and assigns its address to a reference of type `Node`. This works because `NodeI` is derived from `Node`, so a `Node` reference can refer to an instance of type `NodeI`. However, if we want to invoke a method of the `NodeI` class at this point, we must use a `NodeI` reference:

```
NodeI servant = new NodeI("Fred");
```

Whether you use a `Node` or a `NodeI` reference depends purely on whether you want to invoke a method of the `NodeI` class: if not, a `Node` reference works just as well as a `NodeI` reference.

16.8.2 Creating an Identity

Each Ice object requires an identity. That identity must be unique for all servants using the same object adapter.² An Ice object identity is a structure with the following Slice definition:

2. The Ice object model assumes that all objects (regardless of their adapter) have a globally unique identity. See XREF for further discussion.

```
module Ice {
    struct Identity {
        string name;
        string category;
    };
    // ...
};
```

The full identity of an object is the combination of both the name and category fields of the `Identity` structure. For now, we will leave the category field as the empty string and simply use the name field. (See Section 31.6 for a discussion of the category field.)

To create an identity, we simply assign a key that identifies the servant to the name field of the `Identity` structure:

```
Ice.Identity id = new Ice.Identity();
id.name = "Fred"; // Not unique, but good enough for now
```

16.8.3 Activating a Servant

Merely creating a servant instance does nothing: the Ice run time becomes aware of the existence of a servant only once you explicitly tell the object adapter about the servant. To activate a servant, you invoke the `add` operation on the object adapter. Assuming that we have access to the object adapter in the `_adapter` variable, we can write:

```
_adapter.add(servant, id);
```

Note the two arguments to `add`: the servant and the object identity. Calling `add` on the object adapter adds the servant and the servant's identity to the adapter's servant map and links the proxy for an Ice object to the correct servant instance in the server's memory as follows:

1. The proxy for an Ice object, apart from addressing information, contains the identity of the Ice object. When a client invokes an operation, the object identity is sent with the request to the server.
2. The object adapter receives the request, retrieves the identity, and uses the identity as an index into the servant map.
3. If a servant with that identity is active, the object adapter retrieves the servant from the servant map and dispatches the incoming request into the correct method on the servant.

Assuming that the object adapter is in the active state (see Section 31.4), client requests are dispatched to the servant as soon as you call `add`.

16.8.4 UUIDs as Identities

As we discussed in Section 2.5.1, the Ice object model assumes that object identities are globally unique. One way of ensuring that uniqueness is to use UUIDs (Universally Unique Identifiers) [14] as identities. The `Ice.Util` package contains a helper function to create such identities:

```
public class Example
{
    public static void Main(string[] args)
    {
        System.Console.WriteLine(Ice.Util.generateUUID());
    }
}
```

When executed, this program prints a unique string such as `5029a22c-e333-4f87-86b1-cd5e0fcce509`. Each call to `generateUUID` creates a string that differs from all previous ones.³ You can use a UUID such as this to create object identities. For convenience, the object adapter has an operation `addWithUUID` that generates a UUID and adds a servant to the servant map in a single step. Using this operation, we can create an identity and register a servant with that identity in a single step as follows:

```
_adapter.addWithUUID(new NodeI("Fred"));
```

16.8.5 Creating Proxies

Once we have activated a servant for an Ice object, the server can process incoming client requests for that object. However, clients can only access the object once they hold a proxy for the object. If a client knows the server's address details and the object identity, it can create a proxy from a string, as we saw in our first example in Chapter 3. However, creation of proxies by the client in this manner is usually only done to allow the client access to initial objects for boot-

3. Well, almost: eventually, the UUID algorithm wraps around and produces strings that repeat themselves, but this will not happen until approximately the year 3400.

strapping. Once the client has an initial proxy, it typically obtains further proxies by invoking operations.

The object adapter contains all the details that make up the information in a proxy: the addressing and protocol information, and the object identity. The Ice run time offers a number of ways to create proxies. Once created, you can pass a proxy to the client as the return value or as an out-parameter of an operation invocation.

Proxies and Servant Activation

The `add` and `addWithUUID` servant activation operations on the object adapter return a proxy for the corresponding Ice object. This means we can write:

```
NodePrx proxy = NodePrxHelper.uncheckedCast(
    _adapter.addWithUUID(new NodeI("Fred")));
```

Here, `addWithUUID` both activates the servant and returns a proxy for the Ice object incarnated by that servant in a single step.

Note that we need to use an `uncheckedCast` here because `addWithUUID` returns a proxy of type `Ice.ObjectPrx`.

Direct Proxy Creation

The object adapter offers an operation to create a proxy for a given identity:

```
module Ice {
    local interface ObjectAdapter {
        Object* createProxy(Identity id);
        // ...
    };
};
```

Note that `createProxy` creates a proxy for a given identity whether a servant is activated with that identity or not. In other words, proxies have a life cycle that is quite independent from the life cycle of servants:

```
Ice.Identity id = new Ice.Identity();
id.name = Ice.Util.generateUUID();
Ice.ObjectPrx o = _adapter.createProxy(id);
```

This creates a proxy for an Ice object with the identity returned by `generateUUID`. Obviously, no servant yet exists for that object so, if we return the proxy to a client and the client invokes an operation on the proxy, the client will receive an `ObjectNotExistException`. (We examine these life cycle issues in more detail in XREF.)

16.9 Summary

This chapter presented the server-side C# mapping. Because the mapping for Slice data types is identical for clients and servers, the server-side mapping only adds a few additional mechanisms to the client side: a small API to initialize and finalize the run time, plus a few rules for how to derive servant classes from skeletons and how to register servants with the server-side run time.

Even though the examples in this chapter are very simple, they accurately reflect the basics of writing an Ice server. Of course, for more sophisticated servers (which we discuss in Chapter 31), you will be using additional APIs, for example, to improve performance or scalability. However, these APIs are all described in Slice, so, to use these APIs, you need not learn any C# mapping rules beyond those we described here.

Chapter 17

Developing a File System Server in C#

17.1 Chapter Overview

In this chapter, we present the source code for a C# server that implements the file system we developed in Chapter 5 (see Chapter 15 for the corresponding client). The code we present here is fully functional, apart from the required interlocking for threads. (We examine threading issues in detail in Section 31.9.)

17.2 Implementing a File System Server

We have now seen enough of the server-side C# mapping to implement a server for the file system we developed in Chapter 5. (You may find it useful to review the Slice definition for our file system in Section 5 before studying the source code.)

Our server is composed of three source files:

- `Server.cs`

This file contains the server main program.

- `DirectoryI.cs`

This file contains the implementation for the `Directory` servants.

- `FileI.cs`

This file contains the implementation for the `File` servants.

17.2.1 The Server Main Program

Our server main program, in the file `Server.cs`, uses the `Ice.Application` class we discussed in Section 16.3.1. The `run` method installs a signal handler, creates an object adapter, instantiates a few servants for the directories and files in the file system, and then activates the adapter. This leads to a `Main` method as follows:

```
using Filesystem;
using System;

public class Server : Ice.Application
{
    public override int run(string[] args)
    {
        // Terminate cleanly on receipt of a signal
        //
        shutdownOnInterrupt();

        // Create an object adapter (stored in the _adapter
        // static members)
        //
        Ice.ObjectAdapter adapter
            = communicator().createObjectAdapterWithEndpoints(
                "SimpleFilesystem", "default -p 10000");
        DirectoryI._adapter = adapter;
        FileI._adapter = adapter;

        // Create the root directory (with name "/" and no parent)
        //
        DirectoryI root = new DirectoryI("/", null);

        // Create a file called "README" in the root directory
        //
        File file = new FileI("README", root);
        string[] text;
        text = new string[]{ "This file system contains "
            + "a collection of poetry." };
        try {
            file.write(text);
        } catch (GenericError e) {
```

```
        Console.Error.WriteLine(e.reason);
    }

    // Create a directory called "Coleridge"
    // in the root directory
    //
    DirectoryInfo coleridge = new DirectoryInfo("Coleridge", root);

    // Create a file called "Kubla_Khan"
    // in the Coleridge directory
    //
    file = new FileI("Kubla_Khan", coleridge);
    text = new string[] { "In Xanadu did Kubla Khan",
        "A stately pleasure-dome decree:",
        "Where Alph, the sacred river, ran",
        "Through caverns measureless to man",
        "Down to a sunless sea." };

    try {
        file.write(text);
    } catch (GenericError e) {
        Console.Error.WriteLine(e.reason);
    }

    // All objects are created, allow client requests now
    //
    adapter.activate();

    // Wait until we are done
    //
    communicator().waitForShutdown();

    if (interrupted())
        Console.Error.WriteLine(appName() + ": terminating");

    return 0;
}

public static void Main(string[] args)
{
    Server app = new Server();
    Environment.Exit(app.main(args));
}
}
```

The code uses a using directive for the the `FileSystem` namespace. This avoids having to continuously use fully-qualified identifiers with a `FileSystem.` prefix.

The next part of the source code is the definition of the `Server` class, which derives from `Ice.Application` and contains the main application logic in its `run` method. Much of this code is boiler plate that we saw previously: we create an object adapter, and, towards the end, activate the object adapter and call `wait-ForShutdown`.

The interesting part of the code follows the adapter creation: here, the server instantiates a few nodes for our file system to create the structure shown in Figure 17.1.

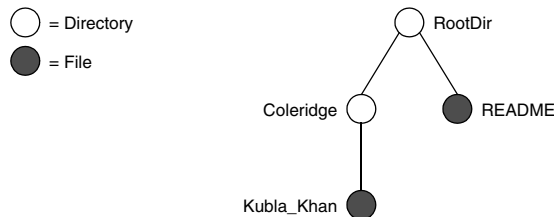

Figure 17.1. A small file system.

As we will see shortly, the servants for our directories and files are of type `DirectoryI` and `FileI`, respectively. The constructor for either type of servant accepts two parameters, the name of the directory or file to be created and a reference to the servant for the parent directory. (For the root directory, which has no parent, we pass a null parent.) Thus, the statement

```
DirectoryI root = new DirectoryI("/", null);
```

creates the root directory, with the name `"/"` and no parent directory.

Here is the code that establishes the structure in Figure 17.1:

```
// Create the root directory (with name "/" and no parent)
//
DirectoryI root = new DirectoryI("/", null);

// Create a file called "README" in the root directory
//
FileI file = new FileI("README", root);
string[] text;
text = new string[]{ "This file system contains "
                    + "a collection of poetry." };
```



```
try {
    file.write(text);
} catch (GenericError e) {
    Console.Error.WriteLine(e.reason);
}

// Create a directory called "Coleridge"
// in the root directory
//
DirectoryI coleridge = new DirectoryI("Coleridge", root);

// Create a file called "Kubla_Khan"
// in the Coleridge directory
//
file = new FileI("Kubla_Khan", coleridge);
text = new string[] { "In Xanadu did Kubla Khan",
                     "A stately pleasure-dome decree:",
                     "Where Alph, the sacred river, ran",
                     "Through caverns measureless to man",
                     "Down to a sunless sea." };

try {
    file.write(text);
} catch (GenericError e) {
    Console.Error.WriteLine(e.reason);
}
```

We first create the root directory and a file README within the root directory. (Note that we pass a reference to the root directory as the parent when we create the new node of type `FileI`.)

The next step is to fill the file with text:

```
string[] text;
text = new string[] { "This file system contains "
                    + "a collection of poetry." };

try {
    file.write(text);
} catch (GenericError e) {
    Console.Error.WriteLine(e.reason);
}
```

Recall from Section 14.7.3 that Slice sequences by default map to C# arrays. The Slice type `Lines` is simply an array of strings; we add a line of text to our README file by initializing the `text` array to contain one element.

Finally, we call the Slice write operation on our `FileI` servant by simply writing:

```
file.write(text);
```

This statement is interesting: the server code invokes an operation on one of its own servants. Because the call happens via a reference to the servant (of type `FileI`) and *not* via a proxy (of type `FilePrx`), the Ice run time does not know that this call is even taking place—such a direct call into a servant is not mediated by the Ice run time in any way and is dispatched as an ordinary C# method call.

In similar fashion, the remainder of the code creates a subdirectory called `Coleridge` and, within that directory, a file called `Kubla_Khan` to complete the structure in Figure 17.1.

17.2.2 The `FileI` Servant Class

Our `FileI` servant class has the following basic structure:

```
using FileSystem;
using System;

public class FileI : FileDisp_
{
    // Constructor and operations here...

    public static Ice.ObjectAdapter _adapter;
    private string _name;
    private DirectoryI _parent;
    private string[] _lines;
}
```

The class has a number of data members:

- `_adapter`
This static member stores a reference to the single object adapter we use in our server.
- `_name`
This member stores the name of the file incarnated by the servant.
- `_parent`
This member stores the reference to the servant for the file's parent directory.
- `_lines`
This member holds the contents of the file.

The `_name` and `_parent` data members are initialized by the constructor:

```
public FileI(string name, DirectoryI parent)
{
    _name = name;
    _parent = parent;

    Debug.Assert(_parent != null);

    // Create an identity
    //
    Ice.Identity myID
        = Ice.Util.stringToIdentity(Ice.Util.generateUUID());

    // Add the identity to the object adapter
    //
    _adapter.add(this, myID);

    // Create a proxy for the new node and
    // add it as a child to the parent
    //
    NodePrx thisNode = NodePrxHelper.uncheckedCast(
        _adapter.createProxy(myID));
    _parent.addChild(thisNode);
}
```

After initializing the `_name` and `_parent` members, the code verifies that the reference to the parent is not null because every file must have a parent directory. The constructor then generates an identity for the file by calling `Ice.Util.generateUUID` and adds itself to the servant map by calling `ObjectAdapter.add`. Finally, the constructor creates a proxy for this file and calls the `addChild` method on its parent directory. `addChild` is a helper function that a child directory or file calls to add itself to the list of descendant nodes of its parent directory. We will see the implementation of this function on page 479.

The remaining methods of the `FileI` class implement the Slice operations we defined in the `Node` and `File Slice` interfaces:

```
// Slice Node::name() operation

public override string name(Ice.Current current)
{
    return _name;
}

// Slice File::read() operation
```

```
public override string[] read(Ice.Current current)
{
    return _lines;
}

// Slice File::write() operation

public override void write(string[] text, Ice.Current current)
{
    _lines = text;
}
```

The `name` method is inherited from the generated `Node` interface (which is a base interface of the `_FileDisp` class from which `FileI` is derived). It simply returns the value of the `_name` member.

The `read` and `write` methods are inherited from the generated `File` interface (which is a base interface of the `_FileDisp` class from which `FileI` is derived) and simply return and set the `_lines` member.

17.2.3 The DirectoryI Servant Class

The `DirectoryI` class has the following basic structure:

```
using Filesystem;
using System;
using System.Collections;

public class DirectoryI : DirectoryDisp_
{
    // Constructor and operations here...

    public static Ice.ObjectAdapter _adapter;
    private string _name;
    private DirectoryI _parent;
    private ArrayList _contents = new ArrayList();
}
```

As for the `FileI` class, we have data members to store the object adapter, the name, and the parent directory. (For the root directory, the `_parent` member holds a null reference.) In addition, we have a `_contents` data member that stores the list of child directories. These data members are initialized by the constructor:

```

public DirectoryI(string name, DirectoryI parent)
{
    _name = name;
    _parent = parent;

    // Create an identity. The
    // parent has the fixed identity "RootDir"
    //
    Ice.Identity myID = Ice.Util.stringToIdentity(
        _parent != null
            ? Ice.Util.generateUUID()
            : "RootDir");

    // Add the identity to the object adapter
    //
    _adapter.add(this, myID);

    // Create a proxy for the new node and
    // add it as a child to the parent
    //
    NodePrx thisNode = NodePrxHelper.uncheckedCast(
        _adapter.createProxy(myID));
    if (_parent != null)
        _parent.addChild(thisNode);
}

```

The constructor creates an identity for the new directory by calling `Ice.Util.generateUUID`. (For the root directory, we use the fixed identity "RootDir".) The servant adds itself to the servant map by calling `ObjectAdapter.add` and then creates a proxy to itself and passes it to the `addChild` helper function.

`addChild` simply adds the passed reference to the `_contents` list:

```

public void addChild(NodePrx child)
{
    _contents.Add(child);
}

```

The remainder of the operations, `name` and `list`, are trivial:

```

public override string name(Ice.Current current)
{
    return _name;
}

```

```
public override NodePrx[] list(Ice.Current current)
{
    return (NodePrx[])_contents.ToArray(typeof(NodePrx));
}
```

Note that the `_contents` member is of type `System.Collections.ArrayList`, which is convenient for the implementation of the `addChild` method. However, this requires us to convert the list into a C# array in order to return it from the `list` operation.

17.3 Summary

This chapter showed how to implement a complete server for the file system we defined in Chapter 5. Note that the server is remarkably free of code that relates to distribution: most of the server code is simply application logic that would be present just the same for a non-distributed version. Again, this is one of the major advantages of Ice: distribution concerns are kept away from application code so that you can concentrate on developing application logic instead of networking infrastructure.

Note that the server code we presented here is not quite correct as it stands: if two clients access the same file in parallel, each via a different thread, one thread may read the `_lines` data member while another thread updates it. Obviously, if that happens, we may write or return garbage or, worse, crash the server. However, it is trivial to make the `read` and `write` operations thread-safe. We discuss thread safety in Section 31.9.

Part III.D

Visual Basic Mapping

Chapter 18

Client-Side Slice-to-Visual Basic Mapping

18.1 Chapter Overview

In this chapter, we present the client-side Slice-to-Visual Basic (VB) mapping (see Chapter 8 for the server-side mapping). One part of the client-side VB mapping concerns itself with rules for representing each Slice data type as a corresponding VB type; we cover these rules in Section 18.3 to Section 18.10. Another part of the mapping deals with how clients can invoke operations, pass and receive parameters, and handle exceptions. These topics are covered in Section 18.11 to Section 18.13. Slice classes have the characteristics of both data types and interfaces and are covered in Section 18.14.

18.2 Introduction

The client-side Slice-to-VB mapping defines how Slice data types are translated to VB types, and how clients invoke operations, pass parameters, and handle errors. Much of the VB mapping is intuitive. For example, Slice dictionaries map to a VB class that derives from `System.Collections.DictionaryBase`, so there is little you have learn in order to use Slice dictionaries in VB.

The VB and C# mappings are binary compatible, that is, compiling a Slice definition with `slice2vb` and `slice2cs` results in generated code that, when

compiled, provides binary compatible APIs. This allows you to freely mix both languages in your application.

The VB API to the Ice run time is fully thread-safe. Obviously, you must still synchronize access to data from different threads. For example, if you have two threads sharing a sequence, you cannot safely have one thread insert into the sequence while another thread is iterating over the sequence. However, you only need to concern yourself with concurrent access to your own data—the Ice run time itself is fully thread safe, and none of the Ice API calls require you to acquire or release a lock before you safely can make the call.

Much of what appears in this chapter is reference material. We suggest that you skim the material on the initial reading and refer back to specific sections as needed. However, we recommend that you read at least Section 18.10 to Section 18.13 in detail because these sections cover how to call operations from a client, pass parameters, and handle exceptions.

A word of advice before you start: in order to use the VB mapping, you should need no more than the Slice definition of your application and knowledge of the VB mapping rules. In particular, looking through the generated code in order to discern how to use the VB mapping is likely to be inefficient, due to the amount of detail. Of course, occasionally, you may want to refer to the generated code to confirm a detail of the mapping, but we recommend that you otherwise use the material presented here to see how to write your client-side code.

18.3 Mapping for Identifiers

Slice identifiers map to an identical VB identifier. For example, the Slice identifier `Clock` becomes the VB identifier `Clock`. If a Slice identifier is the same as a VB keyword, the corresponding VB identifier is an *escaped identifier* (an identifier surrounded with `[]`). For example, the Slice identifier `while` is mapped as `[while]`.¹

The Slice-to-VB compiler generates classes that inherit from interfaces or base classes in the .NET framework. These interfaces and classes introduce a number of methods into derived classes. To avoid name clashes between Slice identifiers that happen to be the same as an inherited method, such identifiers are

1. As suggested in Section 4.5.3 on page 86, you should try to avoid such Slice identifiers as much as possible.

prefixed by `ice_` and suffixed with `_` in the generated code. For example, the Slice identifier `Equals` maps to the VB identifier `ice_Equals_` if it would clash with an inherited `Equals`. The complete list of identifiers that are so changed is:

<code>Clone</code>	<code>Equals</code>	<code>Finalize</code>
<code>GetBaseException</code>	<code>GetHashCode</code>	<code>GetObjectData</code>
<code>GetType</code>	<code>MemberwiseClone</code>	<code>ReferenceEquals</code>
<code>ToString</code>	<code>checkedCast</code>	<code>uncheckedCast</code>

Note that Slice identifiers in this list are translated to the corresponding VB identifier only where necessary. For example, structures do not derive from `ICloneable`, so if a Slice structure contains a member named `Clone`, the corresponding VB structure's member is named `Clone` as well. On the other hand, classes do derive from `ICloneable`, so, if a Slice class contains a member named `Clone`, the corresponding VB class's member is named `ice_Clone_`.

Also note that, for the purpose of prefixing, Slice identifiers are case-insensitive, that is, both `Clone` and `clone` are escaped and map to `ice_Clone_` and `ice_clone_`, respectively. (Of course, as far as Visual Basic is concerned, `ice_Clone_` and `ice_clone_` are the same identifier because VB identifiers are case-insensitive.)

18.4 Mapping for Modules

Slice modules map to VB namespaces with the same name as the Slice module. The mapping preserves the nesting of the Slice definitions. For example:

```
module M1 {
    // Definitions for M1 here...
    module M2 {
        // Definitions for M2 here...
    };
};

// ...

module M1 { // Reopen M1
    // More definitions for M1 here...
};
```

This definition maps to the corresponding VB definitions:

```
Namespace M1
    ' Definitions for M1 here...

Namespace M2
    ' Definitions for M2 here...

End Namespace

End Namespace

Namespace M1
    ' More definitions for M1 here...

End Namespace
```

If a Slice module is reopened, the corresponding VB namespace is reopened as well.

18.5 The Ice Namespace

All of the APIs for the Ice run time are nested in the Ice namespace, to avoid clashes with definitions for other libraries or applications. Some of the contents of the Ice namespace are generated from Slice definitions; other parts of the Ice namespace provide special-purpose definitions that do not have a corresponding Slice definition. We will incrementally cover the contents of the Ice namespace throughout the remainder of the book.

18.6 Mapping for Simple Built-In Types

The Slice built-in types are mapped to VB types as shown in Table 18.1.

Table 18.1. Mapping of Slice built-in types to VB.

Slice	VB
bool	Boolean
byte	Byte
short	Short
int	Integer
long	Long
float	Single
double	Double
string	String

18.7 Mapping for User-Defined Types

Slice supports user-defined types: enumerations, structures, sequences, and dictionaries.

18.7.1 Mapping for Enumerations

Enumerations map to the corresponding enumeration in VB. For example:

```
enum Fruit { Apple, Pear, Orange };
```

Not surprisingly, the generated VB definition is analogous:

```
Public Enum Fruit
    Apple
    Pear
    Orange
End Enum
```

18.7.2 Mapping for Structures

Ice for Visual Basic supports two different mappings for structures. By default, Slice structures map to VB structures if they (recursively) contain only value types. If a Slice structure (recursively) contains a string, proxy, class, sequence, or dictionary member, it maps to a VB class. A metadata directive (see Section 4.17) allows you to force the mapping to a VB class for Slice structures that contain only value types.

In addition, for either mapping, you can control whether Slice data members are mapped to fields or to properties (see page 491).

Structure Mapping for Structures

Consider the following structure:

```
struct Point {
    double x;
    double y;
};
```

This structure consist of only value types and so, by default, maps to a VB structure:

```
Public Structure Point

    Public x As Double
    Public y As Double

    Public Sub New(ByVal x As Double, ByVal y As Double)

    Public Overrides Function GetHashCode() As Integer
    Public Overloads Overrides Function Equals( _
        ByVal other As Object) As Boolean

End Structure
```

For each data member in the Slice definition, the VB structure contains a corresponding public data member of the same name.

The generated constructor accepts one argument for each structure member, in the order in which they are defined in the `Slice` definition. This allows you to construct and initialize a structure in a single statement:

```
Dim p As Point = New Point(5.1, 7.8)
```

The structure overrides the `GetHashCode` and `Equals` methods to allow you to use it as the key type of a dictionary. (Note that the shared two-argument version of `Equals` is inherited from `System.Object`.) Two structures are equal if (recursively) all their data members are equal. Otherwise, they are not equal. For structures that contain reference types, `Equals` performs a deep comparison; that is, reference types, such as strings and dictionaries, are compared for value equality, not reference equality.

Class Mapping for Structures

The mapping for `Slice` structures to VB structures provides value semantics. Usually, this is appropriate, but there are situations where you may want to change this:

- If you use structures as members of a collection, each access to an element of the collection incurs the cost of boxing or unboxing. Depending on your situation, the performance penalty may be noticeable.
- On occasion, it is useful to be able to assign `Nothing` to a structure, for example, to support “not there” semantics (such as when implementing parameters that are conceptually optional).

To allow you to choose the correct performance and functionality trade-off, the `Slice-to-VB` compiler provides an alternative mapping of structures to classes, for example:

```
["clr:class"] struct Point {  
    double x;  
    double y;  
};
```

The `"clr:class"` metadata directive instructs the `Slice-to-VB` compiler to generate a mapping to a VB class for this structure. The generated code is iden-

tical, except that the keyword `struct` is replaced by the keyword `class`² and that the class also inherits from `ICloneable`:

```
Public Class Point
    Implements _System.ICloneable

    Public x As Double
    Public y As Double

    Public Sub New()
    Public Sub New(ByVal x As Double, ByVal y As Double)

    Function Clone() As Object Implements _System.ICloneable.Clone

    Public Overrides Function GetHashCode() As Integer
    Public Overloads Overrides Function Equals(_
        ByVal other As Object) As Boolean

End Class
```

The `Clone` method performs a shallow memberwise copy, and the comparison methods have the usual semantics (they perform value comparison).

Note that you can influence the mapping for structures only at the point of definition of a structure, that is, for a particular structure type, you must decide whether you want to use the structure or the class mapping. (You cannot override the structure mapping elsewhere, for example, for individual structure members or operation parameters.)

As we mentioned previously, if a Slice structure (recursively) contains a member of reference type, it is automatically mapped to a VB class. (The compiler behaves as if you had explicitly specified the “`clr:class`” metadata directive for the structure.)

Here is our `Employee` structure from Section 4.9.4 once more:

```
struct Employee {
    long number;
    string firstName;
    string lastName;
};
```

2. Some of the generated marshaling code differs for the class mapping of structures, but this is irrelevant to application code.

The structure contains two strings, which are reference types, so the Slice-to-VB compiler generates a VB class for this structure:

```
Public Structure Employee

    Public number As Long
    Public firstName As String
    Public lastName As String

    Public Sub New(ByVal number As Long, _
                  ByVal firstName As String, _
                  ByVal lastName As String)

    Public Overrides Function GetHashCode() As Integer

    Public Overloads Overrides Function Equals( _
                  ByVal other As Object) As Boolean

End Structure
```

Property Mapping for Structures

You can instruct the compiler to emit property definitions instead of public data members. For example:

```
["clr:property"] struct Point {
    double x;
    double y;
};

["clr:property"] struct Point {
    double x;
    double y;
};
```

The “clr:property” metadata directive causes the compiler to generate a property for each Slice data member:

```
Public Structure Point

    Private x_prop As Double
    Public Property x As Double
        Get
            Return x_prop
        End Get
        Set
            x_prop = Value
        End Set
    End Property
End Structure
```

```

        End Set
    End Property

    Private y_prop As Double
    Public Property y As Double
        Get
            Return y_prop
        End Get
        Set
            y_prop = Value
        End Set
    End Property

    ' Other methods here...

End Structure

```

Note that the properties are not overridable because VB structures cannot have overridable properties. However, if you apply the “clr:property” directive to a structure that contains a member of reference type, or if you combine the “clr:property” and “clr:class” directives, the generated properties are overridable. For example:

```

["clr:property", "clr:class"]
struct Point {
    double x;
    double y;
};

```

This generates the following code:

```

Public Class Point
    Implements System.ICloneable

    Private x_prop As Double
    Public Overridable Property x As Double
        Get
            Return x_prop
        End Get
        Set
            x_prop = Value
        End Set
    End Property

    Private y_prop As Double
    Public Overridable Property y As Double

```

```
        Get
            Return y_prop
        End Get
        Set
            y_prop = Value
        End Set
    End Property

    ' Other methods here...

End Structure
```

18.7.3 Mapping for Sequences

Ice for Visual Basic supports two different mappings for sequences. By default, sequences are mapped to arrays. A metadata directive (see Section 4.17) allows you to instead map sequences to classes that are derived from `System.Collections.CollectionBase`.

Array Mapping for Sequences

By default, the Slice-to-VB compiler maps sequences to arrays. Interestingly, no code is generated in this case; you simply define an array of elements to model the Slice sequence. For example:

```
sequence<Fruit> FruitPlatter;
```

Given this definition, to create a sequence containing an apple and an orange, you could write:

```
Dim fp() As Fruit = New Fruit() { Fruit.Apple, Fruit.Orange }
```

Or, alternatively:

```
Dim fp() As Fruit = New Fruit(1)
fp(0) = Fruit.Apple
fp(1) = Fruit.Orange
```

The array mapping for sequences is both simple and efficient, especially for sequences of value types because accessing array elements does not require boxing and unboxing.

CollectionBase Mapping for Sequences

The mapping of sequences to arrays is simple, but has the disadvantage that the number of elements in the sequence is fixed when you instantiate the array. This

makes the array mapping useless in situations where you need to grow and shrink a sequence on demand.³ To allow you to choose the correct feature trade-off, the Slice-to-VB compiler provides an alternative mapping, for example:

```
["clr:collection"] sequence<Fruit> FruitPlatter;
```

The "clr:collection" metadata directive instructs the Slice-to-VB compiler to generate a mapping to a VB class that derives from `System.Collections.CollectionBase`:

```
Public Class FruitPlatter
    Inherits System.Collections.CollectionBase
    Implements System.ICloneable

    Public Sub New()
    Public Sub New(ByVal capacity As Integer)
    Public Sub New(ByVal a As Fruit())

    Public Sub CopyTo(ByVal a As Fruit())
    Public Sub CopyTo(ByVal a As Fruit(), _
        ByVal i As Integer)
    Public Sub CopyTo(ByVal i As Integer, _
        ByVal a As Fruit(), _
        ByVal ai As Integer, _
        ByVal c As Integer)
    Public Function ToArray() As Fruit()

    Public Sub AddRange(ByVal s As FruitPlatter)
    Public Sub AddRange(ByVal a As Fruit())

    Default Property Item(ByVal index As Integer) As Fruit
        Get
        Set

    Public Function Add(ByVal value As Fruit) As Integer
    Public Function IndexOf(ByVal value As Fruit) As Integer
    Public Sub Insert(ByVal index As Integer, _
        ByVal value As Fruit)
    Public Sub Remove(ByVal value As Fruit)
    Public Function Contains(ByVal value As Fruit) As Boolean
```

3. You can resize an array with `ReDim`; however, `ReDim` does not permit you to arbitrarily resize multi-dimensional arrays and therefore does not provide a general solution.

```
Property Capacity As Integer
    Get
    Set

Public Overridable Sub TrimToSize()

Public Overloads Overridable Sub Sort()
Public Overloads Overridable Sub Sort(ByVal comparer _
    As _System.Collections.IComparer)
Public Overloads Overridable Sub Sort(_
    ByVal index As Integer, ByVal count As Integer, _
    ByVal Comparer As _System.Collections.IComparer)
Public Sub Reverse()
Public Overridable Sub Reverse( _
    ByVal index As Integer, ByVal count As Integer)

Public Overridable Function BinarySearch( _
    ByVal value As M.Fruit) As Integer
Public Overridable Function BinarySearch( _
    ByVal value As M.Fruit, _
    ByVal comparer As _System.Collections.IComparer) _
    As Integer
Public Overridable Function BinarySearch( _
    ByVal index As Integer, _
    ByVal count As Integer, _
    ByVal value As M.Fruit, _
    ByVal comparer As _System.Collections.IComparer) _
    As Integer

Public Overridable Sub InsertRange( _
    ByVal index As Integer, ByVal c As FruitPlatter)
Public Overridable Sub InsertRange( _
    ByVal index As Integer, ByVal c As M.Fruit())

Public Overridable Sub RemoveRange( _
    ByVal index As Integer, ByVal count As Integer)
Public Overridable Function GetRange( _
    ByVal index As Integer, ByVal count As Integer) _
    As FruitPlatter

Public Overridable Sub SetRange( _
    ByVal index As Integer, ByVal c As FruitPlatter)
Public Overridable Sub SetRange( _
    ByVal index As Integer, ByVal c As M.Fruit())

Public Overridable Function LastIndexOf( _
```

```

        ByVal value As M.Fruit) As Integer
Public Overridable Function LastIndexOf( _
    ByVal value As M.Fruit, ByVal startIndex As Integer) _
    As Integer
Public Overridable Function LastIndexOf( _
    ByVal value As M.Fruit, _
    ByVal startIndex As Integer, _
    ByVal count As Integer) As Integer

Public Shared Function Repeat( _
    ByVal value As M.Fruit, ByVal count As Integer) _
    As FruitPlatter

Function Clone() As Object Implements System.ICloneable.Clone

Public Overrides Function GetHashCode() As Integer

Public Overloads Overrides Function Equals( _
    ByVal other As Object) As Boolean

Public Overloads Shared Function Equals( _
    ByVal lhs As FruitPlatter, _
    ByVal rhs As FruitPlatter) As Boolean

' ...

End Class

```

The generated `FruitPlatter` class provides implementations of the indexer (Get and Set methods), and the inherited `Add`, `IndexOf`, `Insert`, `Remove`, and `Contains` methods. (The `CollectionBase` base class provides implementations of yet more methods, such as `RemoveAt` and `Clear`.) To make sequences easier to use, the `Slice-to-VB` compiler adds a number of additional properties and methods:

- `Sub New()`
`Sub New(ByVal capacity As Integer)`
`Sub New(ByVal a As Fruit())`

Apart from calling the default constructor, you can also specify an initial capacity for the sequence or, using the array constructor, initialize a sequence from an array.

- `Sub CopyTo(ByVal a As Fruit())`
`Sub CopyTo(ByVal a As Fruit(), _`

```

        ByVal i As Integer)
Sub CopyTo(ByVal i As Integer, _
        ByVal a As Fruit(), _
        ByVal ai As Integer, _
        ByVal c As Integer)

```

These methods copy the contents of a sequence into an array. The semantics are the same as for the corresponding methods on `System.Collections.ArrayList`.

- Function `ToArray() As Fruit()`

The `ToArray` method returns the contents of the sequence as an array.

- Sub `AddRange(ByVal s As FruitPlatter)`
Sub `AddRange(ByVal a As Fruit())`

The `AddRange` methods append the contents of a sequence or an array to the current sequence, respectively.

- Property `Capacity As Integer`
Get
Set

This property controls the capacity of the sequence. Its semantics are as for `System.Collections.ArrayList`.

- Overridable Sub `TrimToSize()`

This method sets the capacity of the sequence to the actual number of elements.

- Overridable Sub `Sort()`
Overridable Sub `Sort(comparer As _
System.Collections.IComparer)`
Overridable Sub `Sort(_
ByVal index As Integer, _
ByVal count As Integer, _
ByVal comparer As System.Collections.IComparer)`

These methods sort the sequence.

- Overridable Sub `Reverse()`
Overridable Sub `Reverse(_
ByVal index As Integer, _
ByVal count As Integer)`

These methods reverse the order of elements of the sequence.

- Overridable Function BinarySearch(_
 ByVal value As Fruit) As Integer
Overridable Function BinarySearch(_
 ByVal value As Fruit, _
 ByVal comparer As System.Collections.IComparer) _
 As Integer
Overridable Function BinarySearch(_
 ByVal index As Integer, _
 ByVal count As Integer, _
 ByVal value As Fruit, _
 ByVal comparer As System.Collections.IComparer) _
 As Integer

The methods perform a binary search on the sequence, with semantics as for `System.Collections.ArrayList`.

- Overridable Sub InsertRange(_
 ByVal index As Integer, _
 ByVal c As FruitPlatter)
Overridable Sub InsertRange(_
 ByVal index As Integer, _
 ByVal c As Fruit())

These methods insert a range of values into the sequence starting at the given index.

- Overridable Sub RemoveRange(_
 ByVal index As Integer, ByVal count As Integer)

This method removes count elements, starting at the given index.

- Overridable Function GetRange(_
 ByVal index As Integer, _
 ByVal count As Integer) As FruitPlatter

This method returns a subrange of the sequence. Note that, unlike `System.Collections.ArrayList.GetRange`, this method returns an independent copy of the subrange instead of a view on the underlying sequence.

- Overridable Sub SetRange(_
 ByVal index As Integer, ByVal c As FruitPlatter)

```
Overridable Sub SetRange( _
    ByVal index As Integer, ByVal c As Fruit())
```

These methods copy the provided sequence over a range of elements in the target sequence, starting at the provided index, with semantics as for `System.Collections.ArrayList`

- ```
Overridable Function LastIndexOf(_
 ByVal value As Fruit) As Integer
```

```
Overridable Function LastIndexOf(_
 ByVal value As Fruit, _
 ByVal startIndex As Integer) As Integer
```

```
Overridable Function LastIndexOf(_
 ByVal value As Fruit, _
 ByVal startIndex As Integer, _
 ByVal count As Integer) As Integer
```

These methods search for the provided element and return its last occurrence in the sequence, as for `System.Collections.ArrayList.LastIndexOf`.

- ```
Shared Function Repeat( _
    ByVal value As Fruit, ByVal count As Integer) _
    As FruitPlatter
```

This method returns a sequence with `count` elements that are initialized to `value`.

Note that all these methods perform a shallow copy, that is, if you have a sequence whose elements have reference type, what is copied are the references, not the objects denoted by those references.

The generated class also provides the usual `GetHashCode` and `Equals` methods. (Two sequences are equal if they have the same number of elements and all elements in corresponding positions are equal.)

The `Clone` method performs a shallow copy.

The class also implements the inherited `IsFixedSize`, `IsReadOnly`, and `IsSynchronized` properties (which return `False`), and the inherited `SyncRoot` property (which returns `this`).

Creating a sequence containing an apple and an orange is simply a matter of writing:

```
Dim fp() As FruitPlatter = New FruitPlatter
fp.Add(Fruit.Apple)
fp.Add(Fruit.Orange)
```

Which Mapping to Choose?

Note that you can influence the mapping for sequences only at the point of definition of a sequence, that is, you must decide up front whether you want to use the `CollectionBase` or the array mapping for a particular sequence type. (You cannot override the sequence mapping elsewhere, for example, for individual structure members or operation parameters.)

The convenience of the `CollectionBase` mapping is not without its cost: sequences of value types (such as a sequence of `int`) are considerably slower for insertion and removal of elements than arrays, due to the cost of boxing and unboxing of the values. In practice, the array mapping for sequences is likely to yield a performance gain if the element type is a value type. For example, if you are using a `sequence<byte>` to model buffers for transmission of (large) binary data, the array mapping is likely to be considerably faster.

Multi-Dimensional Sequences

Slice permits you to define sequences of sequences, for example:

```
enum Fruit { Apple, Orange, Pear };
["clr:collection"] sequence<Fruit> FruitPlatter;
["clr:collection"] sequence<FruitPlatter> Cornucopia;
```

If we use these definitions as shown, the generated code for the `Cornucopia` sequence (with some details removed for clarity) looks as follows:

```
Public Class Cornucopia
    Inherits System.Collections.CollectionBase
    Implements System.ICloneable

    Default Property Item(ByVal index As Integer) As FruitPlatter
        Get
        Set

    Public Function Add(ByVal value As FruitPlatter) As Integer
    Public Function IndexOf(ByVal value As FruitPlatter) _
        As Integer
    Public Sub Insert(ByVal index As Integer, _
        ByVal value As FruitPlatter)
    Public Sub Remove(ByVal value As FruitPlatter)
    Public Function Contains(ByVal value As FruitPlatter) _
        As Boolean

    ' ...
End Class
```

As you can see, the `Cornucopia` class deals with elements of type `FruitPlatter`, as you would expect.

Now let us modify the definition to change the mapping of `FruitPlatter` to an array:

```
enum Fruit { Apple, Orange, Pear };
sequence<Fruit> FruitPlatter;
["clr:collection"] sequence<FruitPlatter> Cornucopia;
```

With this definition, the generated code for `Cornucopia` looks as follows (again, with some details removed for clarity):

```
Public Class Cornucopia
    Inherits System.Collections.CollectionBase
    Implements System.ICloneable

    Public Function Add(ByVal value As Fruit()) As Integer

    Public Function IndexOf(ByVal value As Fruit()) As Integer
    Public Sub Insert(ByVal index As Integer, _
                    ByVal value As Fruit())
    Public Sub Remove(ByVal value As Fruit())
    Public Function Contains(ByVal value As Fruit()) _
                        As Boolean

    ' ...
End Class
```

As you can see, the generated code now no longer mentions the type `FruitPlatter` anywhere and deals with the elements of `Cornucopia` as an array of `Fruit` instead.

Of course, we could also change the metadata directive to make the `Cornucopia` sequence an array, and use the `CollectionBase` mapping for `FruitPlatter`. In that case, the compiler does not generate any definitions for `Cornucopia` at all—there is no need to generate anything because the application code now has to treat `Cornucopia` as an array of `FruitPlatter` throughout.

18.8 Mapping for Dictionaries

Here is the definition of our `EmployeeMap` from Section 4.9.4 once more:

```
dictionary<long, Employee> EmployeeMap;
```

The Slice-to-VB compiler maps the dictionary to a class with the same name:

```
Public Class EmployeeMap
    Inherits System.Collections.DictionaryBase
    Implements System.ICloneable

    Default Property Item(ByVal key As Long) As Employee
        Get
        Set

    ReadOnly Property Keys As System.Collections.ICollection
        Get

    ReadOnly Property Values As System.Collections.ICollection
        Get

    Public Sub AddRange(ByVal d As EmployeeMap)

    Public Sub Add(ByVal key As Long, ByVal value As Employee)
    Public Sub Remove(ByVal key As Long)
    Public Function Contains(ByVal key As Long)

    Function Clone() As Object Implements System.ICloneable.Clone

    Public Overrides Function GetHashCode() As Integer

    Public Overloads Overrides Function Equals(_
        ByVal other As Object) As Boolean

    Public Overloads Shared Function Equals(_
        ByVal lhs As EmployeeMap, _
        ByVal rhs As EmployeeMap) As Boolean

    ' ...
End Class
```

Note that the generated `EmployeeMap` class inherits from `DictionaryBase`, so it follows the standard conventions of the .NET framework. Apart from methods inherited from `DictionaryBase`, the class provides an `AddRange` method that allows you to append the contents of one dictionary to another. If the target dictionary contains a key that is also in the source dictionary, the target dictionary's value is preserved. For example:

```
Dim e1 As Employee = New Employee
e1.number = 42
e1.firstName = "Herb"
e1.lastName = "Sutter"

Dim em1 As EmployeeMap = New EmployeeMap
em(42) = e

Dim e2 As Employee = New Employee
e2.number = 42
e2.firstName = "Stan"
e2.lastName = "Lipmann"

Dim em2 As EmployeeMap = New EmployeeMap
em(42) = e2

' Add contents of em2 to em1
'
em1.AddRange(em2)

' Equal keys preserve the original value
'
Debug.Assert(em1(42).firstName.Equals("Herb"))
```

The generated class also provides the usual `GetHashCode` and `Equals` methods. (Two dictionaries are equal if they contain the same number of entries and, for each entry, the key and value are the same.)

The `Clone` method performs a shallow copy.

The class also implements the inherited `IsFixedSize`, `IsReadOnly`, and `IsSynchronized` properties (which return `False`), and the inherited `SyncRoot` property (which returns `this`).

18.9 Mapping for Constants

Here are the constant definitions we saw in Section 4.9.5 on page 97 once more:

```
const bool      AppendByDefault = true;
const byte      LowerNibble = 0x0f;
const string    Advice = "Don't Panic!";
const short     TheAnswer = 42;
```

```
const double    PI = 3.1416;

enum Fruit { Apple, Pear, Orange };
const Fruit    FavoriteFruit = Pear;
```

Here are the generated definitions for these constants:

```
Public NotInheritable Class AppendByDefault
    Public Const value As Boolean = True
End Class

Public NotInheritable Class LowerNibble
    Public Const value As Byte = 15
End Class

Public NotInheritable Class Advice
    Public Const value As String = "Don't Panic!"
End Class

Public NotInheritable Class TheAnswer
    Public Const value As Short = 42S
End Class

Public NotInheritable Class PI
    Public Const value As Double = 3.1416R
End Class

Public Enum Fruit
    Apple
    Pear
    Orange
End Enum

Public NotInheritable Class FavoriteFruit
    Public Const value As Fruit = Fruit.Pear
End Class
```

As you can see, each Slice constant is mapped to a class with the same name as the constant. The class contains a member named `value` that holds the value of the constant.⁴

4. The mapping to classes instead of to plain constants is necessary because VB does not permit constant definitions at global or namespace scope.

18.10 Mapping for Exceptions

The mapping for exceptions is based on the inheritance hierarchy shown in Figure 18.1

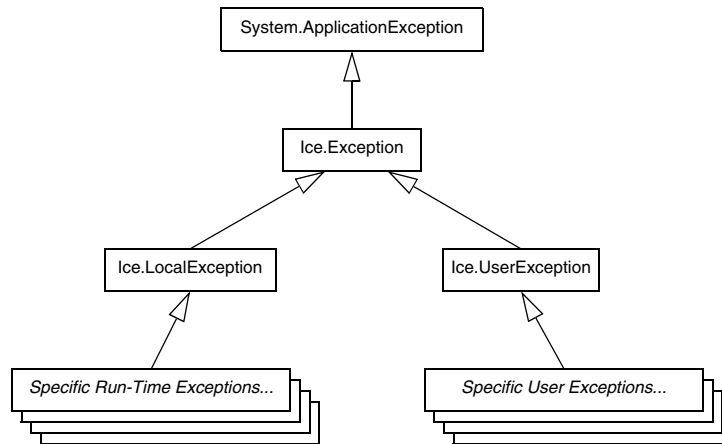

Figure 18.1. Inheritance structure for exceptions.

The ancestor of all exceptions is `System.ApplicationException`. Derived from that is `Ice.Exception`, which provides the definitions for a number of constructors. `Ice.LocalException` and `Ice.UserException` are derived from `Ice.Exception` and form the base for all run-time and user exceptions.

The constructors defined in `Ice.Exception` have the following signatures:

```

Public MustInherit Class Exception
    Inherits System.ApplicationException

    Public Sub New()
    Public Sub New(ByVal msg As String)
    Public Sub New(ByVal ex As System.Exception)
    Public Sub New(ByVal msg As String, _
        ByVal ex As System.Exception)

End Class
  
```

Each concrete derived exception class implements these constructors. The constructors initialize the `Message` and `InnerException` properties of

ApplicationException. (The default constructor initializes the Message property to the name of the exception.)

Here is a fragment of the Slice definition for our world time server from Section 4.10.5 on page 113 once more:

```
exception GenericError {
    string reason;
};
exception BadTimeVal extends GenericError {};
exception BadZoneName extends GenericError {};
```

These exception definitions map as follows:

```
Public Class GenericError
    Inherits Ice.UserException

    Public reason As String

    Public Sub New()
    Public Sub New(ByVal msg As String)
    Public Sub New(ByVal ex As System.Exception)
    Public Sub New(ByVal msg As String, _
        ByVal ex As System.Exception)

    ' GetHashCode and comparison methods defined here,
    ' as well as mapping-internal methods.
End Class

Public Class BadTimeVal
    Inherits GenericError

    Public Sub New()
    Public Sub New(ByVal msg As String)
    Public Sub New(ByVal ex As System.Exception)
    Public Sub New(ByVal msg As String, _
        ByVal ex As System.Exception)

    ' GetHashCode and comparison methods defined here,
    ' as well as mapping-internal methods.
End Class

Public Class BadZoneName
    Inherits GenericError

    Public Sub New()
    Public Sub New(ByVal msg As String)
```



```
Public Sub New(ByVal ex As System.Exception)
Public Sub New(ByVal msg As String, _
                ByVal ex As System.Exception)

    ' GetHashCode and comparison methods defined here,
    ' as well as mapping-internal methods.
End Class
```

Each Slice exception is mapped to a VB class with the same name. For each exception member, the corresponding class contains a public data member. (Obviously, because `BadTimeVal` and `BadZoneName` do not have members, the generated classes for these exceptions also do not have members.)

The inheritance structure of the Slice exceptions is preserved for the generated classes, so `BadTimeVal` and `BadZoneName` inherit from `GenericError`.

All user exceptions are derived from the base class `Ice.UserException`. This allows you to catch all user exceptions generically by installing a handler for `Ice.UserException`. Similarly, you can catch all Ice run-time exceptions with a handler for `Ice.LocalException`, and you can catch all Ice exceptions with a handler for `Ice.Exception`.

All exceptions also provide the usual `GetHashCode` and `Equals` methods.

The generated exception classes also contain other member functions that are not shown here; these member functions are internal to the VB mapping and are not meant to be called by application code.

18.11 Mapping for Interfaces

On the client side, Slice interfaces map to VB interfaces with member functions that correspond to the operations on those interfaces. Consider the following simple interface:

```
interface Simple {
    void op();
};
```

The Slice compiler generates the following definition for use by the client:

```

Public Interface SimplePrx
    Inherits Ice.ObjectPrx

    Sub op()
    Sub op(ByVal __context As Ice.Context)

End Interface

```

As you can see, the compiler generates a *proxy interface* `SimplePrx`. In general, the generated name is `<interface-name>Prx`. If an interface is nested in a module `M`, the generated interface is part of namespace `M`, so the fully-qualified name is `M.<interface-name>Prx`.

In the client's address space, an instance of `SimplePrx` is the local ambassador for a remote instance of the `Simple` interface in a server and is known as a *proxy instance*. All the details about the server-side object, such as its address, what protocol to use, and its object identity are encapsulated in that instance.

Note that `SimplePrx` inherits from `Ice.ObjectPrx`. This reflects the fact that all `Ice` interfaces implicitly inherit from `Ice::Object`.

For each operation in the interface, the proxy class has a member function of the same name. For the preceding example, we find that the operation `op` has been mapped to the method `op`. Also note that `op` is overloaded: the second version of `op` has a parameter `__context` of type `Ice.Context`. This parameter is for use by the `Ice` run time to store information about how to deliver a request. You normally do not need to use it. (We examine the `__context` parameter in detail in Chapter 31. The parameter is also used by `IceStorm`—see Chapter 43.)

Because all the `<interface-name>Prx` types are interfaces, you cannot instantiate an object of such a type. Instead, proxy instances are always instantiated on behalf of the client by the `Ice` run time, so client code never has any need to instantiate a proxy directly. The proxy references handed out by the `Ice` run time are always of type `<interface-name>Prx`; the concrete implementation of the interface is part of the `Ice` run time and does not concern application code.

18.11.1 The `Ice.ObjectPrx` Interface

All `Ice` objects have `Object` as the ultimate ancestor type, so all proxies inherit from `Ice.ObjectPrx`. `ObjectPrx` provides a number of methods:

```

Namespace Ice

```

```

    Public Interface ObjectPrx
        Function ice_getIdentity() As Identity

```

```

Function ice_getHash() As Boolean
Function ice_isA(string __id) As Boolean
Function ice_id() As String
Sub ice_ping()

// Defined in a helper class:
//
Function GetHashCode() As Integer
Function Equals(object __r) As Boolean
Shared Function Equals(Ice.ObjectPrx __lhs, Ice.ObjectPrx
__rhs) As Boolean

' ...
End Interface

End Namespace

```

Note that the `GetHashCode` and `Equals` methods are not actually defined in `Ice.ObjectPrx`, but in a helper class that becomes a base class of an instantiated proxy. However, this is simply an internal detail of the VB mapping—conceptually, these methods belong with `Ice.ObjectPrx`, so we discuss them here.

The methods behave as follows:

- `ice_getIdentity`

This method returns the identity of the object denoted by the proxy. The identity of an Ice object has the following `Slice` type:

```

module Ice {
    struct Identity {
        string name;
        string category;
    };
};

```

To see whether two proxies denote the same object, first obtain the identity for each object and then compare the identities:

```

Dim o1 As Ice.ObjectPrx = ...
Dim o2 As Ice.ObjectPrx = ...
Dim i1 As Ice.Identity = o1.ice_getIdentity()
Dim i2 As Ice.Identity = o2.ice_getIdentity()

If i1.Equals(i2) Then
    ' o1 and o2 denote the same object

```

```
Else
    ' o1 and o2 denote different objects
End If
```

- `ice_getHash`

This method returns a hash key for the proxy. (It is a synonym for `GetHashCode`.)

- `ice_isA`

This method determines whether the object denoted by the proxy supports a specific interface. The argument to `ice_isA` is a type ID (see Section 4.13). For example, to see whether a proxy of type `ObjectPrx` denotes a `Printer` object, we can write:

```
Ice.ObjectPrx o = ...;
If Not o Is Nothing AndAlso o.ice_isA("::Printer") Then
    ' o denotes a Printer object
Else
    ' o denotes some other type of object
End If
```

Note that we attempt to invoke the `ice_isA` method only if the proxy is not `Nothing` to avoid getting a `NullReferenceException` if the proxy is `Nothing`.

- `ice_id`

This method returns the type ID of the object denoted by the proxy. Note that the type returned is the type of the actual object, which may be more derived than the static type of the proxy. For example, if we have a proxy of type `BasePrx`, with a static type ID of `::Base`, the return value of `ice_id` might be `::Base`, or it might something more derived, such as `::Derived`.

- `ice_ping`

This method provides a basic reachability test for the object. If the object can physically be contacted (that is, the object exists and its server is running and reachable), the call completes normally; otherwise, it throws an exception that indicates why the object could not be reached, such as `ObjectNotExistException` or `ConnectTimeoutException`.

- `Equals`

This operation compares two proxies for equality. Note that all aspects of proxies are compared by this operation, such as the communication endpoints for the proxy. This means that, in general, if two proxies compare unequal,

that does *not* imply that they denote different objects. For example, if two proxies denote the same `Ice` object via different transport endpoints, `Equals` returns `False` even though the proxies denote the same object.

Note that there are other methods in `ObjectPrx`, not shown here. These methods provide different ways to dispatch a call and also provide access to an object's facets; we discuss these methods in Chapter 31 and XREF.

18.11.2 Proxy Helpers

For each `Slice` interface, apart from the proxy interface, the `Slice-to-VB` compiler creates a helper class: for an interface `Simple`, the name of the generated helper class is `SimplePrxHelper`.⁵ The helper class contains two methods of interest:

```
Public Class SimplePrxHelper
    Inherits Ice.ObjectPrxHelperBase
    Implements SimplePrx

    Public Shared Function checkedCast( _
        ByVal b As Ice.ObjectPrx) _
        As SimplePrx
    Public Shared Function checkedCast( _
        ByVal b As Ice.ObjectPrx), _
        ByVal ctx As Ice.Context) _
        As SimplePrx
    Public Shared Function uncheckedCast( _
        ByVal B As Ice.ObjectPrx, _
        ByVal f As String) _
        As SimplePrx
    ' ...
End Class
```

Both the `checkedCast` and `uncheckedCast` methods implement a down-cast: if the passed proxy is a proxy for an object of type `Simple`, or a proxy for an object with a type derived from `Simple`, the cast returns a reference to a proxy of type `SimplePrx`; otherwise, if the passed proxy denotes an object of a different type (or if the passed proxy is `Nothing`), the cast returns `Nothing`.

5. You can ignore the `ObjectPrxHelperBase` base class—it exists for mapping-internal purposes.

Given a proxy of any type, you can use a `checkedCast` to determine whether the corresponding object supports a given type, for example:

```
Dim obj As Ice.ObjectPrx = ... ' Get a proxy from somewhere...

Dim simple As SimplePrx = SimplePrxHelper.checkedCast(obj)
If Not simple Is Nothing Then
    ' Object supports the Simple interface...
Else
    ' Object is not of type Simple...
End If
```

Note that a `checkedCast` contacts the server. This is necessary because only the implementation of an object in the server has definite knowledge of the type of an object. As a result, a `checkedCast` may throw a `ConnectTimeoutException` or an `ObjectNotExistException`. (This also explains the need for the helper class: the Ice run time must contact the server, so we cannot use a VB down-cast.)

In contrast, an `uncheckedCast` does not contact the server and unconditionally returns a proxy of the requested type. However, if you do use an `uncheckedCast`, you must be certain that the proxy really does support the type you are casting to; otherwise, if you get it wrong, you will most likely get a run-time exception when you invoke an operation on the proxy. The most likely error for such a type mismatch is `OperationNotExistException`. However, other exceptions, such as a marshaling exception are possible as well. And, if the object happens to have an operation with the correct name, but different parameter types, no exception may be reported at all and you simply end up sending the invocation to an object of the wrong type; that object may do rather non-sensical things. To illustrate this, consider the following two interfaces:

```
interface Process {
    void launch(int stackSize, int dataSize);
};

// ...

interface Rocket {
    void launch(float xCoord, float yCoord);
};
```

Suppose you expect to receive a proxy for a `Process` object and use an `uncheckedCast` to down-cast the proxy:

```

Dim obj As Ice.ObjectPrx = ...           ' Get proxy...
Dim process As ProcessPrx _
    = ProcessPrxHelper.uncheckedCast(obj) ' No worries...
process.launch(40, 60)                   ' Oops...

```

If the proxy you received actually denotes a Rocket object, the error will go undetected by the Ice run time: because `int` and `float` have the same size and because the Ice protocol does not tag data with its type on the wire, the implementation of `Rocket::launch` will simply misinterpret the passed integers as floating-point numbers.

In fairness, this example is somewhat contrived. For such a mistake to go unnoticed at run time, both objects must have an operation with the same name and, in addition, the run-time arguments passed to the operation must have a total marshaled size that matches the number of bytes that are expected by the unmarshaling code on the server side. In practice, this is extremely rare and an incorrect `uncheckedCast` typically results in a run-time exception.

A final warning about down-casts: you must use either a `checkedCast` or an `uncheckedCast` to down-cast a proxy. If you use a VB cast, the behavior is undefined.

18.11.3 Object Identity and Proxy Comparison

As mentioned on page 510, proxies provide an `Equals` operation. Proxy comparison with `Equals` uses *all* of the information in a proxy for the comparison. This means that not only the object identity must match for a comparison to succeed, but other details inside the proxy, such as the protocol and endpoint information, must be the same. In other words, comparison with `Equals` tests for *proxy* identity, *not* object identity. A common mistake is to write code along the following lines:

```

Dim p1 As Ice.ObjectPrx = ...           ' Get a proxy...
Dim p2 As Ice.ObjectPrx = ...           ' Get another proxy...

If p1.Equals(p2) Then
    ' p1 and p2 denote different objects      ' WRONG!
Else
    ' p1 and p2 denote the same object        ' Correct
End If

```

Even though `p1` and `p2` differ, they may denote the same Ice object. This can happen because, for example, both `p1` and `p2` embed the same object identity, but each use a different protocol to contact the target object. Similarly, the protocols

may be the same, but denote different endpoints (because a single Ice object can be contacted via several different transport endpoints). In other words, if two proxies compare equal with `Equals`, we know that the two proxies denote the same object (because they are identical in all respects); however, if two proxies compare unequal with `Equals`, we know absolutely nothing: the proxies may or may not denote the same object.

To compare the object identities of two proxies, you must use a helper function in the `Ice.Util` class:

```
Public NotInheritable Class Util
    Public Shared Function proxyIdentityCompare( _
                                                ByVal lhs As ObjectPrx, _
                                                ByVal rhs As ObjectPrx) As Integer

        Public Shared Function proxyIdentityAndFacetCompare( _
                                                            ByVal lhs As ObjectPrx, _
                                                            ByVal rhs As ObjectPrx) As Integer

        ' ...
End Class
```

`proxyIdentityCompare` allows you to correctly compare proxies for identity:

```
Dim p1 As Ice.ObjectPrx = ...           ' Get a proxy...
Dim p2 As Ice.ObjectPrx = ...           ' Get another proxy...

If Ice.Util.proxyIdentityCompare(p1, p2) <> 0 Then
    ' p1 and p2 denote different objects      ' Correct
Else
    ' p1 and p2 denote the same object        ' Correct
End If
```

The function returns 0 if the identities are equal, -1 if `p1` is less than `p2`, and 1 if `p1` is greater than `p2`. (The comparison uses name as the major and category as the minor sort key.)

The `proxyIdentityAndFacetCompare` performs the same function, but compares both the identity and the facet name (see Chapter 33).

The VB mapping also provides two helper classes in the `Ice` namespace that allow you to insert proxies into hashtables or ordered collections, based on the identity, or the identity plus the facet name:

```
Public Class proxyIdentityKey
    Implements System.Collections.IHashCodeProvider, _
               System.Collections.IComparer
```



```

Public Function Compare(ByVal x As Object, ByVal y As Object)
    As Integer _
    Implements System.Collections.IComparer.Compare

Public Overloads Function GetHashCode(ByVal obj As Object) _
    As Integer _
    Implements System.Collections.IHashCodeProvider.GetHashCode

' ...
End Class

```

Note these classes derive from `IHashCodeProvider` and `IComparer`, so they can be used for both hash tables and ordered collections.

18.12 Mapping for Operations

As we saw in Section 18.11, for each operation on an interface, the proxy class contains a corresponding member function with the same name. To invoke an operation, you call it via the proxy. For example, here is part of the definitions for our file system from Section 5.4:

```

module Filesystem {
    interface Node {
        nonmutating string name();
    };
    // ...
};

```

The `name` operation returns a value of type `string`. Given a proxy to an object of type `Node`, the client can invoke the operation as follows:

```

Dim node As NodePrx = ... ' Initialize proxy
Dim name As String = node.name() ' Get name via RPC

```

This illustrates the typical pattern for receiving return values: return values are returned by reference for complex types, and by value for simple types (such as `int` or `double`).

18.12.1 Normal, idempotent, and nonmutating Operations

You can add an `idempotent` or `nonmutating` qualifier to a `Slice` operation. As far as the signature for the corresponding proxy methods is concerned, neither `idem-`

potent nor nonmutating have any effect. For example, consider the following interface:

```
interface Example {
    string op1();
    idempotent string op2();
    nonmutating string op3();
};
```

The proxy interface for this is:

```
Public Interface ExamplePrx
    Inherits Ice.ObjectPrx

    Function op1 () As String
    Function op2 () As String
    Function op3 () As String
End Interface
```

`idempotent` and `nonmutating` affect an aspect of call dispatch, not interface, so it makes sense for the three methods to look the same.

18.12.2 Passing Parameters

In-Parameters

The parameter passing rules for the VB mapping are very simple: parameters are passed either by value (for value types) or by reference (for reference types). Semantically, the two ways of passing parameters are identical: it is guaranteed that the value of a parameter will not be changed by the invocation (with some caveats—see XREF).

Here is an interface with operations that pass parameters of various types from client to server:

```
struct NumberAndString {
    int x;
    string str;
};

sequence<string> StringSeq;

dictionary<long, StringSeq> StringTable;

interface ClientToServer {
```

```

    void op1(int i, float f, bool b, string s);
    void op2(NumberAndString ns, StringSeq ss, StringTable st);
    void op3(ClientToServer* proxy);
};

```

The Slice compiler generates the following proxy for this definition:

```

Public Interface ClientToServerPrx
    Inherits Ice.ObjectPrx

    Sub op1(ByVal i As Integer, _
            ByVal f As float, _
            ByVal b As Boolean, _
            ByVal s As String)

    Sub op2(ByVal ns As NumberAndString, _
            ByVal ss As StringSeq, _
            ByVal st As StringTable)

    Sub op3(ByVal proxy As ClientToServerPrx)
End Interface

```

Given a proxy to a ClientToServer interface, the client code can pass parameters as in the following example:

```

Dim p As ClientToServerPrx = ...           ' Get proxy...

p.op1(42, 3.14F, True, "Hello world!")    ' Pass simple literals

Dim i As Integer = 42
Dim f As Single f = 3.14F;
Dim b As Boolean = True
Dim s As String = "Hello world!"
p.op1(i, f, b, s)                         ' Pass simple variables

Dim ns As NumberAndString = New NumberAndString
ns.x = 42
ns.str = "The Answer"
Dim ss As StringSS = New StringSS
ss.Add("Hello world!")
Dim st As StringTable = New StringTable
st(0) = ns
p.op2(ns, ss, st)                         ' Pass complex variables

p.op3(p)                                  ' Pass proxy

```

out-Parameters

Slice out parameters simply map to `ByRef` parameters.⁶

Here is the same Slice definition we saw on page 516 once more, but this time with all parameters being passed in the out direction:

```
struct NumberAndString {
    int x;
    string str;
};

sequence<string> StringSeq;

dictionary<long, StringSeq> StringTable;

interface ServerToClient {
    void op1(out int i, out float f, out bool b, out string s);
    void op2(out NumberAndString ns,
            out StringSeq ss,
            out StringTable st);
    void op3(out ServerToClient* proxy);
};
```

The Slice compiler generates the following code for this definition:

```
Imports System.Runtime.InteropServices

Public Interface ServerToClientPrx
    Inherits Ice.ObjectPrx

    Sub op1(<Out ()> ByRef i As Integer, _
          <Out ()> ByRef f As Single, _
          <Out ()> ByRef b As Boolean, _
          <Out ()> ByRef s As String)

    Sub op1(<Out ()> ByRef i As Integer, _
          <Out ()> ByRef f As Single, _
          <Out ()> ByRef b As Boolean, _
          <Out ()> ByRef s As String, _
          ByVal __context As Ice.Context)
```

6. These parameters use `System.Runtime.InteropServices.OutAttribute` in order to preserve binary compatibility with the C# mapping, which maps Slice out parameters to C# out parameters.

```

Sub op2(<Out ()> ByRef ns As M.NumberAndString, _
        <Out ()> ByRef ss As String(), _
        <Out ()> ByRef st As M.StringTable)

Sub op2(<Out ()> ByRef ns As M.NumberAndString, _
        <Out ()> ByRef ss As String(), _
        <Out ()> ByRef st As M.StringTable, _
        ByVal __context As Ice.Context)

Sub op3(<Out ()> ByRef proxy As M.ServerToClientPrx)

Sub op3(<Out ()> ByRef proxy As M.ServerToClientPrx, _
        ByVal __context As Ice.Context)

```

End Interface

Given a proxy to a `ServerToClient` interface, the client code can pass parameters as in the following example:

```

Dim p As ClientToServerPrx = ... ' Get proxy...

Dim i As Integer
Dim f As Single
Dim b As Boolean
Dim s As String
p.op1(i, f, b, s)

Dim ns As NumberAndString
Dim ss As StringSeq
Dim st As StringTable
p.op2(out ns, out ss, out st)

Dim stc As ServerToClientPrx
p.op3(out stc);

System.Console.WriteLine(i)          ' Show one of the values

```

Null Parameters

Some `Slice` types naturally have “empty” or “not there” semantics. Specifically, proxies, sequences (if mapped to `CollectionBase`), dictionaries, strings, and structures (if mapped to classes) can be `Nothing`:

- For proxies, a VB `Nothing` reference denotes the null proxy. The null proxy is a dedicated value that indicates that a proxy points “nowhere” (denotes no object).

- Sequences and dictionaries cannot be null, but can be empty. To make life with these types easier, whenever you pass a VB `Nothing` reference as a parameter or return value of type sequence or dictionary, the Ice run time automatically sends an empty sequence or dictionary to the receiver.
- VB strings can be `Nothing`, but Slice strings cannot (because Slice strings do not support the concept of a null string). Whenever you pass a VB `Nothing` string as a parameter or return value, the Ice run time automatically sends an empty string to the receiver.
- Structures can be null if you use the `CollectionBase` mapping. If you pass a VB `Nothing` reference to such a structure as a parameter or return value, the Ice run time automatically sends a structure whose elements are default initialized. This means that all proxy members are initialized to `Nothing`, sequence and dictionary members are initialized to empty collections, strings are initialized to the empty string, and members that have a value type are initialized to their default values.

This behavior is useful as a convenience feature: especially for deeply-nested data types, members that are structures, sequences, dictionaries, or strings automatically arrive as an empty value at the receiving end. This saves you having to explicitly initialize, for example, every string element in a large sequence before sending it in order to avoid `NullReferenceExceptions`. Note that using `Nothing` parameters in this way does *not* create null semantics for sequences, dictionaries, or strings. As far as the object model is concerned, these do not exist (only *empty* sequences, dictionaries, and strings do). For example, sending a string as a `Nothing` reference or as an empty string makes no difference to the receiver: either way, the receiver sees an empty string.

18.13 Exception Handling

Any operation invocation may throw a run-time exception (see Section 18.10 on page 505) and, if the operation has an exception specification, may also throw user exceptions (see Section 18.10 on page 505). Suppose we have the following simple interface:

```
exception Tantrum {
    string reason;
};

interface Child {
    void askToCleanUp() throws Tantrum;
};
```

Slice exceptions are thrown as VB exceptions, so you can simply enclose one or more operation invocations in a Try-Catch block:

```
Dim child As ChildPrx = ... ' Get child proxy...

Try
    child.askToCleanUp()
Catch t As Tantrum
    System.Console.Write("The child says: ")
    System.Console.WriteLine(t.reason)
End Try
```

Typically, you will catch only a few exceptions of specific interest around an operation invocation; other exceptions, such as unexpected run-time errors, will typically be handled by exception handlers higher in the hierarchy. For example:

```
Module Client

    Private Sub run()
        Dim child As ChildPrx = ... ' Get child proxy...
        Try
            child.askToCleanUp()
        Catch t As Tantrum
            System.Console.Write("The child says: ")
            System.Console.WriteLine(t.reason)
            child.scold() ' Recover from error...
        End Try
        child.praise() ' Give positive feedback...
    End Sub

    Public Sub Main(ByVal args() As String)
        Try
            ' ...
            run()
            ' ...
        Catch e As Ice.Exception
            System.Console.WriteLine(e)
        End Try
    End Sub
End Module
```

```
        End Try
    End Sub

End Module
```

This code handles a specific exception of local interest at the point of call and deals with other exceptions generically. (This is also the strategy we used for our first simple application in XREF.)

Note that the `ToStRiNg` method of exceptions prints the name of the exception, any inner exceptions, and the stack trace. Of course, you can be more selective in the way exceptions are displayed. For example, `e.Message` contains the error message (if any) for the exception, and `e.GetType().Name` returns the (unscoped) name of an exception.

Exceptions and out-Parameters

The Ice run time makes no guarantees about the state of out-parameters when an operation throws an exception: the parameter may still have its original value or may have been changed by the operation's implementation in the target object. In other words, for out-parameters, Ice provides the weak exception guarantee [21] but does not provide the strong exception guarantee.⁷

18.14 Mapping for Classes

Slice classes are mapped to VB classes with the same name. By default, the generated class contains a public data member for each Slice data member (just as for structures and exceptions), and a member function for each operation.

Note that classes also support the “`clr:property`” metadata directive, so you can generate classes with overridable properties instead of data members. (See page 491 for details on “`clr:property`”.)

Consider the following class definition:

7. This is done for reasons of efficiency: providing the strong exception guarantee would require more overhead than can be justified.

```

class TimeOfDay {
    short hour;           // 0 - 23
    short minute;        // 0 - 59
    short second;        // 0 -59
    string format();     // Return time as hh:mm:ss
};

```

The Slice compiler generates the following code for this definition:

```

Public Interface TimeOfDayOperations_
    Function format(ByVal __current As Ice.Current) As String
End Interface

Public Interface TimeOfDayOperationsNC_
    Function format() As String
End Interface

Public MustInherit Class TimeOfDay
    Inherits Ice.ObjectImpl
    Implements TimeOfDayOperations_, TimeOfDayOperationsNC_

    Public hour As Short
    Public minute As Short
    Public second As Short

    Public Sub New()
    End Sub

    Public Sub New(ByVal hour As Short, _
                  ByVal minute As Short, _
                  ByVal second As Short)
        Me.hour = hour
        Me.minute = minute
        Me.second = second
    End Sub

    Public Function format() As String _
        Implements TimeOfDayOperationsNC_.format
        Return format(Ice.ObjectImpl.defaultCurrent)
    End Function

    Public MustOverride Function format(_
        ByVal __current As Ice.Current) As String _
        Implements TimeOfDayOperations_.format
End Class

```

There are a number of things to note about the generated code:

1. The compiler generates “operations interfaces” called `TimeOfDayOperations_` and `TimeOfDayOperationsNC_`. These interfaces contain a method for each Slice operation of the class.
2. The generated class `TimeOfDay` inherits (indirectly) from `Ice.Object`. This means that all classes implicitly inherit from `Ice.Object`, which is the ultimate ancestor of all classes. Note that `Ice.Object` is *not* the same as `Ice.ObjectPrx`. In other words, you *cannot* pass a class where a proxy is expected and vice versa.
If a class has only data members, but no operations, the compiler generates a non-abstract class.
3. The generated class contains a public member for each Slice data member.
4. The generated class inherits member functions for each Slice operation from the operations interfaces.
5. The generated class contains two constructors.

There is quite a bit to discuss here, so we will look at each item in turn.

18.14.1 Operations Interfaces

The methods in the `<interface-name>Operations_` interface have an additional trailing parameter of type `Ice.Current`, whereas the methods in the `<interface-name>OperationsNC_` interface lack this additional trailing parameter. The methods without the `Current` parameter simply forward to the methods with a `Current` parameter, supplying a default `Current`. For now, you can ignore this parameter and pretend it does not exist. (We look at it in more detail in Section 31.6.)

If a class has only data members, but no operations, the compiler omits generating the `<interface-name>Operations_` and `<interface-name>OperationsNC_` interfaces.

18.14.2 Inheritance from `Ice.Object`

Like interfaces, classes implicitly inherit from a common base class, `Ice.Object`. However, as shown in Figure 18.2, classes inherit from `Ice.Object` instead of `Ice.ObjectPrx` (which is at the base of the inheritance hierarchy for proxies). As a result, you cannot pass a class where a proxy is

expected (and vice versa) because the base types for classes and proxies are not compatible.

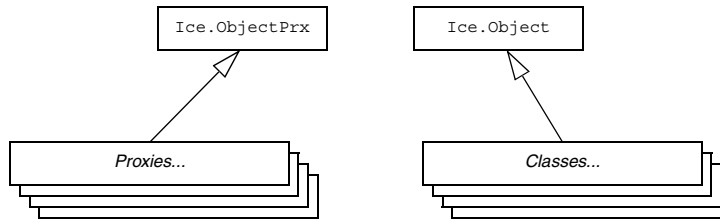

Figure 18.2. Inheritance from `Ice.ObjectPrx` and `Ice.Object`.

`Ice.Object` contains a number of member functions

Namespace `Ice`

Public Interface `Object`

Function `ice_getHash()` As Integer

Function `ice_isA()` As Boolean

Function `ice_isA(ByVal s As String)` As Boolean

Sub `ice_ping()`

Sub `ice_ping(ByVal current As Ice.Current)`

Function `ice_ids()` As String()

Function `ice_ids(ByVal current As Ice.Current)` As String()

Function `ice_id()` As String

Function `ice_id(ByVal current As Ice.Current)`

Sub `ice_preMarshal()`

Sub `ice_postUnmarshal()`

End Interface

End Namespace

The member functions of `Ice.Object` behave as follows:

- `ice_getHash`
This function returns a hash value for the class, allowing you to easily place classes into hash tables. The implementation returns the value of `System.Object.GetHashCode`.
- `ice_isA`
This function returns `true` if the object supports the given type ID, and `false` otherwise.
- `ice_ping`
As for interfaces, `ice_ping` provides a basic reachability test for the class.
- `ice_ids`
This function returns a string sequence representing all of the type IDs supported by this object, including `::Ice::Object`.
- `ice_id`
This function returns the actual run-time type ID for a class. If you call `ice_id` through a reference to a base instance, the returned type id is the actual (possibly more derived) type ID of the instance.
- `ice_preMarshal`
The Ice run time invokes this function prior to marshaling the object's state, providing the opportunity for a subclass to validate its declared data members.
- `ice_postUnmarshal`
The Ice run time invokes this function after unmarshaling an object's state. A subclass typically overrides this function when it needs to perform additional initialization using the values of its declared data members.

Note that the generated class does *not* override `GetHashCode` and `Equals`. This means that classes are compared using shallow reference equality, not value equality (as is used for structures).

The class also provides a `Clone` method (whose implementation is inherited from `Ice.ObjectImpl`); the `Clone` method returns a shallow memberwise copy.

18.14.3 Data Members of Classes

Data members of classes are mapped exactly as for structures and exceptions: for each data member in the Slice definition, the generated class contains a corresponding public data member.

18.14.4 Operations of Classes

Operations of classes are mapped to abstract member functions in the generated class. This means that, if a class contains operations (such as the `format` operation of our `TimeOfDay` class), you must provide an implementation of the operation in a class that is derived from the generated class. For example:

```
Public Class TimeOfDayI
    Inherits TimeOfDay

    Public Overrides Function format( _
        ByVal current As Ice.Current) _
        As String
        Return hour.ToString("D2") & ":" _
            & minute.ToString("D2") & ":" _
            & second.ToString("D2")
    End Function
End Class
```

Class Factories

Having created a class such as `TimeOfDayI`, we have an implementation and we can instantiate the `TimeOfDayI` class, but we cannot receive it as the return value or as an out-parameter from an operation invocation. To see why, consider the following simple interface:

```
interface Time {
    TimeOfDay get();
};
```

When a client invokes the `get` operation, the Ice run time must instantiate and return an instance of the `TimeOfDay` class. However, `TimeOfDay` is an abstract class that cannot be instantiated. Unless we tell it, the Ice run time cannot magically know that we have created a `TimeOfDayI` class that implements the abstract `format` operation of the `TimeOfDay` abstract class. In other words, we must provide the Ice run time with a factory that knows that the `TimeOfDay` abstract class has a `TimeOfDayI` concrete implementation. The `Ice::Communicator` interface provides us with the necessary operations:

```
module Ice {
    local interface ObjectFactory {
        Object create(string type);
        void destroy();
    };
};
```

```

    local interface Communicator {
        void addObjectFactory(ObjectFactory factory, string id);
        ObjectFactory findObjectFactory(string id);
        // ...
    };
};

```

To supply the Ice run time with a factory for our `TimeOfDayI` class, we must implement the `ObjectFactory` interface:

```

Public Class ObjectFactory
    Inherits Ice.LocalObjectImpl
    Implements Ice.ObjectFactory

    Public Function create(ByVal type As String) As Object
        If type.Equals("::M::TimeOfDay") Then
            Return New TimeOfDayI
        End If
        System.Diagnostics.Debug.Assert(False)
        Return Nothing
    End Function

    Public Sub destroy()
        ' Nothing to do
    End Sub

End Class

```

The object factory's `create` method is called by the Ice run time when it needs to instantiate a `TimeOfDay` class. The factory's `destroy` method is called by the Ice run time when its communicator is destroyed.

The `create` method is passed the type ID (see Section 4.13) of the class to instantiate. For our `TimeOfDay` class, the type ID is `::M::TimeOfDay`. Our implementation of `create` checks the type ID: if it is `::M::TimeOfDay`, it instantiates and returns a `TimeOfDayI` object. For other type IDs, it asserts because it does not know how to instantiate other types of objects.

Given a factory implementation, such as our `ObjectFactory`, we must inform the Ice run time of the existence of the factory:

```

Dim ice As Ice.Communicator = ...
ic.addObjectFactory(New ObjectFactory, "::M::TimeOfDay")

```

Now, whenever the Ice run time needs to instantiate a class with the type ID `"::M::TimeOfDay"`, it calls the `create` method of the registered `ObjectFactory` instance, which returns a `TimeOfDayI` instance to the Ice run time.

The `destroy` operation of the object factory is invoked by the Ice run time when the communicator is destroyed. This gives you a chance to clean up any resources that may be used by your factory. Do not call `destroy` on the factory while it is registered with the communicator—if you do, the Ice run time has no idea that this has happened and, depending on what your `destroy` implementation is doing, may cause undefined behavior when the Ice run time tries to next use the factory.

The run time guarantees that `destroy` will be the last call made on the factory, that is, `create` will not be called concurrently with `destroy`, and `create` will not be called once `destroy` has been called. However, calls to `create` can be made concurrently.

Note that you cannot register a factory for the same type ID twice: if you call `addObjectFactory` with a type ID for which a factory is registered, the Ice run time throws an `AlreadyRegisteredException`.

Finally, keep in mind that if a class has only data members, but no operations, you need not create and register an object factory to transmit instances of such a class. Only if a class has operations do you have to define and register an object factory.

Inheritance from `LocalObject`

Note that the implementation of the factory in the previous example extends `Ice.LocalObjectImpl`. The object factory, being a local object, inherits a number of operations from `Ice.LocalObject`, such as `ice_getHash` (see page 510). The `Ice.LocalObjectImpl` class provides implementations for these operations, so you do not need to implement them yourself.

In general, all local interfaces inherit from `Ice.LocalObject`, and all implementations of local interfaces, such as an object factory or servant locator (see Section 31.7) must inherit from `Ice.LocalObjectImpl`.

18.14.5 Class Constructors

The generated class contains both a default constructor, and a constructor that accepts one argument for each member of the class. This allows you to create and initialize a class in a single statement, for example:

```
Dim tod As TimeOfDayI = New TimeOfDay(14, 45, 00) ' 2:45pm
```

```
TimeOfDayI tod = new TimeOfDayI(14, 45, 00); // 2:45pm
```

For derived classes, the constructor requires one argument of all of the members of the class, including members of the base class(es). For example, consider the the definition from Section 4.11.2 once more:

```
class TimeOfDay {
    short hour;           // 0 - 23
    short minute;        // 0 - 59
    short second;        // 0 - 59
};

class DateTime extends TimeOfDay {
    short day;           // 1 - 31
    short month;         // 1 - 12
    short year;          // 1753 onwards
};
```

The constructors for the generated classes are as follows:

```
Public Class TimeOfDay
    Inherits Ice.ObjectImpl

    Public Sub New()
    End Sub

    Public Sub New(ByVal hour As Short, _
                  ByVal minute As Short, _
                  ByVal second As Short)
        Me.hour = hour
        Me.minute = minute
        Me.second = second
    End Sub

    ' ...
End Class

Public Class DateTime
    Inherits M.TimeOfDay

    Public Sub New()
        MyBase.New()
    End Sub

    Public Sub New(ByVal hour As Short, _
                  ByVal minute As Short, _
                  ByVal second As Short, _
```



```
        ByVal day As Short, _  
        ByVal month As Short, _  
        ByVal year As Short)  
    MyBase.New(hour, minute, second)  
    Me.day = day  
    Me.month = month  
    Me.year = year  
End Sub  
  
    ' ...  
End Class
```

In other words, if you want to instantiate and initialize a `DateTime` instance, you must either use the default constructor or provide data for all of the data members of the instance, including data members of any base classes.

18.15 VB-Specific Metadata Directives

The `slice2vb` compiler supports metadata directives that allow you inject VB attribute specifications into the generated code. The metadata directive is `vb:attribute:.` For example:

```
["vb:attribute:System.Serializable"]  
struct Point {  
    double x;  
    double y;  
};
```

This results in the following code being generated for `S`:

```
<System.Serializable>  
Public Structure Point  
    Public x As Double  
    Public y As Double  
    ' ...  
End Structure
```

You can apply this metadata directive to any slice construct, such as structure, operation, or parameter definitions.

You can use this directive also at global level. For example:

```
[["vb:attribute:assembly: AssemblyDescription(\"My assembly\")"]]
```

This results in the following code being inserted following any imports statements and preceding any definitions:

```
<assembly: AssemblyDescription("My assembly")>
```

18.16 `slice2vb` Command-Line Options

The Slice-to-VB compiler, `slice2vb`, offers the following command-line options in addition to the standard options described in Section 4.19:

- `--tie`
Generate tie classes (see Section 16.7).
- `--impl`
Generate sample implementation files. This option will not overwrite an existing file.
- `--impl-tie`
Generate sample implementation files using ties (see Section 16.7). This option will not overwrite an existing file.
- `--checksum`
Generate checksums for Slice definitions.
- `--stream`
Generate streaming helper functions for Slice types (see Section 36.2).

18.17 Using Slice Checksums

As described in Section 4.20, the Slice compilers can optionally generate checksums of Slice definitions. For `slice2vb`, the `--checksum` option causes the compiler to generate checksums in each VB source file that are added to a member of the `Ice.SliceChecksums` class:

```
Namespace Ice
    Public NotInheritable Class SliceChecksums
        Public Readonly Shared checksums As SliceChecksumDict
    End Class
End Namespace
```

The checksums map is initialized automatically prior to first use; no action is required by the application.

In order to verify a server's checksums, a client could simply compare the dictionaries using the `Equals` function. However, this is not feasible if it is possible that the server might be linked with more `Slice` definitions than the client. A more general solution is to iterate over the local checksums as demonstrated below:

```
Dim serverChecksums As Ice.SliceChecksumDict = ...
For Each e As System.Collections.DictionaryEntry _
    In Ice.SliceChecksums.checksums
    Dim checksum As String = serverChecksums(e.Key)
    If checksum Is Nothing Then
        ' No match found for type id!
    ElseIf Not checksum.Equals(e.Value) Then
        ' Checksum mismatch!
    End If
Next
```

In this example, the client first verifies that the server's dictionary contains an entry for each `Slice` type ID, and then it proceeds to compare the checksums.

Chapter 19

Developing a File System Client in Visual Basic

19.1 Chapter Overview

In this chapter, we present the source code for a VB client that accesses the file system we developed in Chapter 5 (see Chapter 21 for the corresponding server).

19.2 The VB Client

We now have seen enough of the client-side VB mapping to develop a complete client to access our remote file system. For reference, here is the Slice definition once more:

```
module Filesystem {
    interface Node {
        nonmutating string name();
    };

    exception GenericError {
        string reason;
    };

    sequence<string> Lines;

    interface File extends Node {
```

```

        nonmutating Lines read();
        idempotent void write(Lines text) throws GenericError;
};

sequence<Node*> NodeSeq;

interface Directory extends Node {
    nonmutating NodeSeq list();
};

interface Filesys {
    nonmutating Directory* getRoot();
};
};

```

To exercise the file system, the client does a recursive listing of the file system, starting at the root directory. For each node in the file system, the client shows the name of the node and whether that node is a file or directory. If the node is a file, the client retrieves the contents of the file and prints them.

The body of the client code looks as follows:

```

Imports Microsoft.VisualBasic
Imports System
Imports FileSystem

Module Client

    ' Recursively print the contents of directory "dir"
    ' in tree fashion. For files, show the contents of
    ' each file. The "depth" parameter is the current
    ' nesting level (for indentation).

    Sub listRecursive(ByVal dir As DirectoryPrx, _
        ByVal depth As Integer)
        depth += 1
        Dim indent As String = New String(Chr(9), depth)

        Dim contents As NodePrx() = dir.list()

        For Each node As NodePrx In contents
            Dim subdir As DirectoryPrx _
                = DirectoryPrxHelper.checkedCast(node)
            Dim file As FilePrx _
                = FilePrxHelper.uncheckedCast(node)
            Console.Write(indent & node.name())

```

```
    If Not subdir Is Nothing Then
        Console.WriteLine(" (directory):")
    Else
        Console.WriteLine(" (file):")
    End If
    If Not subdir Is Nothing Then
        listRecursive(subdir, depth)
    Else
        Dim text As String() = file.read()
        For j As Integer = 0 To text.Length - 1
            Console.WriteLine(indent & " " & text(j))
        Next
    End If
Next
End Sub

Public Sub Main(ByVal args() As String)
    Dim status As Integer = 0
    Dim ic As Ice.Communicator = Nothing
    Try
        ' Create a communicator
        ,
        ic = Ice.Util.initialize(args)

        ' Create a proxy for the root directory
        ,
        Dim obj As Ice.ObjectPrx _
            = ic.stringToProxy("RootDir:default -p 10000")

        ' Down-cast the proxy to a Directory proxy
        ,
        Dim rootDir As DirectoryPrx _
            = DirectoryPrxHelper.checkedCast(obj)

        ' Recursively list the contents of the root directory
        ,
        Console.WriteLine("Contents of root directory:")
        listRecursive(rootDir, 0)
    Catch e As Exception
        Console.Error.WriteLine(e)
        status = 1
    End Try
    If Not ic Is Nothing Then
        ' Clean up
        ,
    Try
```

```

        ic.destroy()
    Catch e As Exception
        Console.Error.WriteLine(e)
        status = 1
    End Try
End If
Environment.Exit(status)
End Sub

```

```
End Module
```

The `Client` module defines two functions: `listRecursive`, which is a helper function to print the contents of the file system, and `Main`, which is the main program. Let us look at `Main` first:

1. The structure of the code in `Main` follows what we saw in Chapter 3. After initializing the run time, the client creates a proxy to the root directory of the file system. For this example, we assume that the server runs on the local host and listens using the default protocol (TCP/IP) at port 10000. The object identity of the root directory is known to be `RootDir`.
2. The client down-casts the proxy to `DirectoryPrx` and passes that proxy to `listRecursive`, which prints the contents of the file system.

Most of the work happens in `listRecursive`. The function is passed a proxy to a directory to list, and an indent level. (The indent level increments with each recursive call and allows the code to print the name of each node at an indent level that corresponds to the depth of the tree at that node.) `listRecursive` calls the `list` operation on the directory and iterates over the returned sequence of nodes:

1. The code does a `checkedCast` to narrow the `Node` proxy to a `Directory` proxy, as well as an `uncheckedCast` to narrow the `Node` proxy to a `File` proxy. Exactly one of those casts will succeed, so there is no need to call `checkedCast` twice: if the `Node` *is-a* `Directory`, the code uses the `DirectoryPrx` returned by the `checkedCast`; if the `checkedCast` fails, we *know* that the `Node` *is-a* `File` and, therefore, an `uncheckedCast` is sufficient to get a `FilePrx`.

In general, if you know that a down-cast to a specific type will succeed, it is preferable to use an `uncheckedCast` instead of a `checkedCast` because an `uncheckedCast` does not incur any network traffic.

2. The code prints the name of the file or directory and then, depending on which cast succeeded, prints " (directory) " or " (file) " following the name.
3. The code checks the type of the node:

- If it is a directory, the code recurses, incrementing the indent level.
- If it is a file, the code calls the read operation on the file to retrieve the file contents and then iterates over the returned sequence of lines, printing each line.

Assume that we have a small file system consisting of two files and a directory as follows:

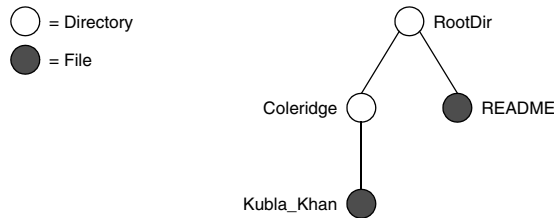

Figure 19.1. A small file system.

The output produced by client for this file system is:

Contents of root directory:

README (file):

This file system contains a collection of poetry.

Coleridge (directory):

Kubla_Khan (file):

In Xanadu did Kubla Khan
A stately pleasure-dome decree:
Where Alph, the sacred river, ran
Through caverns measureless to man
Down to a sunless sea.

Note that, so far, our client (and server) are not very sophisticated:

- The protocol and address information are hard-wired into the code.
- The client makes more remote procedure calls than strictly necessary; with minor redesign of the Slice definitions, many of these calls can be avoided.

We will see how to address these shortcomings in Chapter 37 and XREF.

19.3 Summary

This chapter presented a very simple client to access a server that implements the file system we developed in Chapter 5. As you can see, the VB code hardly differs

from the code you would write for an ordinary VB program. This is one of the biggest advantages of using Ice: accessing a remote object is as easy as accessing an ordinary, local VB object. This allows you to put your effort where you should, namely, into developing your application logic instead of having to struggle with arcane networking APIs. As we will see in Chapter 17, this is true for the server side as well, meaning that you can develop distributed applications easily and efficiently.

Chapter 20

Server-Side Slice-to-Visual Basic Mapping

20.1 Chapter Overview

In this chapter, we present the server-side Slice-to-VB mapping (see Chapter 18 for the client-side mapping). Section 20.3 discusses how to initialize and finalize the server-side run time, sections 20.4 to 20.7 show how to implement interfaces and operations, and Section 20.8 discusses how to register objects with the server-side Ice run time.

20.2 Introduction

The mapping for Slice data types to VB is identical on the client side and server side. This means that everything in Chapter 14 also applies to the server side. However, for the server side, there are a few additional things you need to know, specifically:

- how to initialize and finalize the server-side run time
- how to implement servants
- how to pass parameters and throw exceptions
- how to create servants and register them with the Ice run time.

We discuss these topics in the remainder of this chapter.

20.3 The Server-Side Main Method

The main entry point to the Ice run time is represented by the local interface `Ice::Communicator`. As for the client side, you must initialize the Ice run time by calling `Ice.Util.initialize` before you can do anything else in your server. `Ice.Util.initialize` returns a reference to an instance of an `Ice.Communicator`:

```
Imports System

Module Server

    Public Sub Main(ByVal args() As String)
        Dim status As Integer = 0
        Dim communicator As Ice.Communicator = Nothing
        Try
            communicator = Ice.Util.initialize(args)
            ' ...
        Catch e As Exception
            Console.Error.WriteLine(e)
            status = 1
        End Try
        ' ...
    End Sub

End module
```

`Ice.Util.initialize` accepts the argument vector that is passed to `Main` by the operating system. The method scans the argument vector for any command-line options that are relevant to the Ice run time; any such options are removed from the argument vector so, when `Ice.Util.initialize` returns, the only options and arguments remaining are those that concern your application. If anything goes wrong during initialization, `initialize` throws an exception.

Before leaving your `Main` method, you *must* call `Communicator::destroy`. The `destroy` operation is responsible for finalizing the Ice run time. In particular, `destroy` waits for any operation invocations that may still be running to complete. In addition, `destroy` ensures that any outstanding threads are joined with and reclaims a number of operating system resources, such as file descriptors and memory. Never allow your `Main` method to terminate without calling `destroy` first; doing so has undefined behavior.

The general shape of our server-side `Main` method is therefore as follows:

```
Imports System

Module Server

    Public Sub Main(ByVal args() As String)

        Dim status As Integer = 0
        Dim communicator As Ice.Communicator = Nothing
        Try
            communicator = Ice.Util.initialize(args)
            ' ...
        Catch e As Exception
            Console.Error.WriteLine(e)
            status = 1
        End Try
        If Not communicator Is Nothing Then
            Try
                communicator.destroy()
            Catch e As Exception
                Console.Error.WriteLine(e)
                status = 1
            End Try
        End If
        Environment.Exit(status)
    End Sub

End module
```

Note that the code places the call to `Ice.Util.initialize` into a `try` block and takes care to return the correct exit status to the operating system. Also note that an attempt to destroy the communicator is made only if the initialization succeeded.

20.3.1 The `Ice.Application` Class

The preceding structure for the `Main` method is so common that `Ice` offers a class, `Ice.Application`, that encapsulates all the correct initialization and finalization activities. The synopsis of the class is as follows (with some detail omitted for now):

```
Namespace Ice

    Public MustInherit Class Application

        Public MustOverride Function run( _
```

```

        ByVal args() As String) As Integer

    Public Sub New()

    Public Function main(ByVal args() As String) As Integer
    Public Function main(ByVal args() As String, _
        ByVal configFile As String) _
        As Integer

    Public Shared Function appName() As String

    Public Shared Function communicator() _
        As Ice.Communicator

End Class

```

End Namespace

The intent of this class is that you specialize `Ice.Application` and implement the abstract `run` method in your derived class. Whatever code you would normally place in `Main` goes into the `run` method instead. Using `Ice.Application`, our program looks as follows:

```
Imports System
```

```
Module Server
```

```

    Public Class Server
        Inherits Ice.Application

        Public Overrides Function run(ByVal args As String()) _
            As Integer

            ' Server code here...

            Return 0
        End Function

    End Class

    Public Sub Main(ByVal args As String())
        Dim app As Server = New Server
        Environment.Exit(app.main(args))
    End Sub

```

```
End Module
```

The `Application.main` method does the following:

1. It installs an exception handler for `System.Exception`. If your code fails to handle an exception, `Application.main` prints the name of the exception and a stack trace on `Console.Error` before returning with a non-zero return value.
2. It initializes (by calling `Ice.Util.initialize`) and finalizes (by calling `Communicator.destroy`) a communicator. You can get access to the communicator for your server by calling the static `communicator` accessor.
3. It scans the argument vector for options that are relevant to the Ice run time and removes any such options. The argument vector that is passed to your `run` method therefore is free of Ice-related options and only contains options and arguments that are specific to your application.
4. It provides the name of your application via the static `appName` method. You can get at the application name from anywhere in your code by calling `Ice.Application.appName` (which is usually required for error messages).
5. It creates an `IceUtil.CtrlCHandler` that properly destroys the communicator.

Using `Ice.Application` ensures that your program properly finalizes the Ice run time, whether your server terminates normally or in response to an exception. We recommend that all your programs use this class; doing so makes your life easier. In addition `Ice.Application` also provides features for signal handling and configuration that you do not have to implement yourself when you use this class.

Using `Ice.Application` on the Client Side

You can use `Ice.Application` for your clients as well: simply implement a class that derives from `Ice.Application` and place the client code into its `run` method. The advantage of this approach is the same as for the server side: `Ice.Application` ensures that the communicator is destroyed correctly even in the presence of exceptions.

Catching Signals

The simple server we developed in Chapter 3 had no way to shut down cleanly: we simply interrupted the server from the command line to force it to exit. Terminating a server in this fashion is unacceptable for many real-life server applications: typically, the server has to perform some cleanup work before terminating,

such as flushing database buffers or closing network connections. This is particularly important on receipt of a signal or keyboard interrupt to prevent possible corruption of database files or other persistent data.

To make it easier to deal with signals, `Ice.Application` encapsulates the platform-independent signal handling capabilities provided by the class `IceUtil.CtrlCHandler` (see Section 30.11). This allows you to cleanly shut down on receipt of a signal and to use the same source code regardless of the underlying operating system and VB run time:

```
Namespace Ice

    Public MustInherit Class Application

        ' ...

        Public Shared Sub destroyOnInterrupt()
        Public Shared Sub shutdownOnInterrupt()
        Public Shared Sub ignoreInterrupt()
        Public Shared Sub holdInterrupt()
        Public Shared Sub releaseInterrupt()

        Public Shared Function interrupted() As Boolean

    End Class

End Namespace
```

The methods behave as follows:

- `destroyOnInterrupt`
This method installs a handler that destroys the communicator if it is interrupted. This is the default behavior.
- `shutdownOnInterrupt`
This method installs a handler that shuts down the communicator if it is interrupted.
- `ignoreInterrupt`
This method causes signals to be ignored.
- `holdInterrupt`
This method temporarily blocks signal delivery.

- `releaseInterrupt`

This method restores signal delivery to the previous disposition. Any signal that arrives after `holdInterrupt` was called is delivered when you call `releaseInterrupt`.

- `interrupted`

This method returns `true` if a signal caused the communicator to shut down, `false` otherwise. This allows us to distinguish intentional shutdown from a forced shutdown that was caused by a signal. This is useful, for example, for logging purposes.

By default, `Ice.Application` behaves as if `destroyOnInterrupt` was invoked, therefore our server `Main` method requires no change to ensure that the program terminates cleanly on receipt of a signal. However, we add a diagnostic to report the occurrence, so our `run` method now looks like:

```
Imports System
```

```
Module Server
```

```
    Public Class Server
        Inherits Ice.Application

        Public Overrides Function run(ByVal args As String() _
                                     As Integer)

            ' Server code here...

            If interrupted() Then
                Console.Error.WriteLine(appName() & _
                                       ": terminating")
            End If

            Return 0
        End Function

    End Class

    Public Sub Main(ByVal args As String())
        Dim app As Server = New Server
        Environment.Exit(app.main(args))
    End Sub
```

```
End Module
```

Ice.Application and Properties

Apart from the functionality shown in this section, `Ice.Application` also takes care of initializing the Ice run time with property values. Properties allow you to configure the run time in various ways. For example, you can use properties to control things such as the thread pool size or port number for a server. The `main` method of `Ice.Application` is overloaded; the second version allows you to specify the name of a configuration file that will be processed during initialization. We discuss Ice properties in more detail in Chapter 30.

Limitations of Ice.Application

`Ice.Application` is a singleton class that creates a single communicator. If you are using multiple communicators, you cannot use `Ice.Application`. Instead, you must structure your code as we saw in Chapter 3 (taking care to always destroy the communicator).

20.4 Mapping for Interfaces

The server-side mapping for interfaces provides an up-call API for the Ice run time: by implementing methods in a servant class, you provide the hook that gets the thread of control from the Ice server-side run time into your application code.

20.4.1 Skeleton Classes

On the client side, interfaces map to proxy classes (see Section 5.12). On the server side, interfaces map to *skeleton* classes. A skeleton is a class that has an abstract method for each operation on the corresponding interface. For example, consider the Slice definition for the `Node` interface we defined in Chapter 5 once more:

```
module Filesystem {
    interface Node {
        nonmutating string name();
    };
    // ...
};
```

The Slice compiler generates the following definition for this interface:

```

Namespace FileSystem

    Public Interface NodeOperations_
        Function name(ByVal __current As Ice.Current) As String
    End Interface

    Public Interface NodeOperationsNC_
        Function name() As String
    End Interface

    Public Interface Node
        Inherits Ice.Object, NodeOperations_, NodeOperationsNC_
    End Interface

    Public MustInherit class _NodeDisp
        Inherits Ice.ObjectImpl
        Implements Node

        Public Function name() As String _
            Implements NodeOperationsNC_.name
            Return name(Ice.ObjectImpl.defaultCurrent)
        End Function

        Public MustOverride Function name( _
            ByVal __current As Ice.Current) _
            As String _
            Implements NodeOperations_.name

        ' Mapping-internal code here...

    End Class

End Namespace

```

The important points to note here are:

- As for the client side, Slice modules are mapped to VB namespaces with the same name, so the skeleton class definitions are part of the `FileSystem` namespace.
- For each Slice interface `<interface-name>`, the compiler generates VB interfaces `<interface-name>Operations_` and `<interface-name>OperationsNC_` (`NodeOperations_` and `NodeOperationsNC_` in this example). These interfaces contain a method for each operation in the Slice interface. (You can ignore the `Ice.Current` parameter for the time being—we discuss it in detail in Section 31.6.)

- For each Slice interface *<interface-name>*, the compiler generates a VB interface *<interface-name>* (Node in this example). That interface extends both `Ice.Object` and the two operations interfaces.
- For each Slice interface *<interface-name>*, the compiler generates an abstract class *<interface-name>Disp_* (NodeDisp_ in this example). This abstract class is the actual skeleton class; it is the base class from which you derive your servant class.

20.4.2 Servant Classes

In order to provide an implementation for an Ice object, you must create a servant class that inherits from the corresponding skeleton class. For example, to create a servant for the Node interface, you could write:

```
Imports Filesystem

Public Class NodeI
    Inherits NodeDisp_

    Public Sub New(ByVal name As String)
        _name = name
    End Sub

    Public Overloads Overrides Function name( _
        ByVal current As Ice.Current) As String
        Return _name
    End Function

    Private _name As String
End Class
```

By convention, servant classes have the name of their interface with an I-suffix, so the servant class for the Node interface is called NodeI. (This is a convention only: as far as the Ice run time is concerned, you can chose any name you prefer for your servant classes.) Note that NodeI extends NodeDisp_, that is, it derives from its skeleton class.

As far as Ice is concerned, the NodeI class must implement only a single method: the abstract name method that it inherits from its skeleton. This makes the servant class a concrete class that can be instantiated. You can add other methods and data members as you see fit to support your implementation. For example, in the preceding definition, we added a `_name` member and a

constructor. (Obviously, the constructor initializes the `_name` member and the `name` method returns its value.)

Normal, idempotent, and nonmutating Operations

Whether an operation is an ordinary operation, or an `idempotent` or `nonmutating` operation has no influence on the way the operation is mapped. To illustrate this, consider the following interface:

```
interface Example {
    void normalOp();
    idempotent void idempotentOp();
    nonmutating void nonmutatingOp();
};
```

The operations class for this interface looks like this:

```
Public Interface ExampleOperations_
    Sub normalOp(ByVal current As Ice.Current)
    Sub idempotentOp(ByVal current As Ice.Current)
    Sub nonmutatingOp(ByVal current As Ice.Current)
End Interface
```

Note that the signatures of the methods are unaffected by the `idempotent` and `nonmutating` qualifiers because VB has no notion of const-correctness (whereas, in C++, the `nonmutating` qualifier generates a C++ `const` member function).

20.5 Parameter Passing

For each parameter of a Slice operation, the VB mapping generates a corresponding parameter for the corresponding method in the `<interface-name>Operations_` interface. In addition, every operation has an additional, trailing parameter of type `Ice.Current`. For example, the `name` operation of the `Node` interface has no parameters, but the `name` method of the `NodeOperations_` interface has a single parameter of type `Ice.Current`. We explain the purpose of this parameter in Section 31.6 and will ignore it for now.

To illustrate the rules, consider the following interface that passes string parameters in all possible directions:

```

module M {
    interface Example {
        string op(string sin, out string sout);
    };
};

```

The generated method for `op` looks as follows:

```

Namespace M

    Public Interface ExampleOperations_

        Function op(ByVal sin As String, _
                    <_System.Runtime.InteropServices.Out()> _
                    ByRef sout As String, _
                    ByVal __current As Ice.Current) As String

    End Interface

End Namespace

```

As you can see, there are no surprises here.¹ For example, we could implement `op` as follows:

```

Imports System

Public Class ExampleI
    Inherits M.ExampleDisp_

    Function op(ByVal sin As String, _
                ByRef sout As String, _
                ByVal __current As Ice.Current) As String

        Console.WriteLine(sin) ' In parameters are initialized
        sout = "Hello World!" ' Assign out param
        Return "Done"

    End Function

End Class

```

1. Out-parameters use `System.Runtime.InteropServices.OutAttribute` in order to preserve binary compatibility with the C# mapping, which maps Slice out parameters to C# out parameters.

This code is in no way different from what you would normally write if you were to pass strings to and from a method; the fact that remote procedure calls are involved does not affect your code in any way. The same is true for parameters of other types, such as proxies, classes, or dictionaries: the parameter passing conventions follow normal VB rules and do not require special-purpose API calls.

20.6 Raising Exceptions

To throw an exception from an operation implementation, you simply instantiate the exception, initialize it, and throw it. For example:

```
Public Overloads Overrides Sub write( _
                                ByVal text As String(), _
                                ByVal current As Ice.Current)
    Try
        ' Try to write file contents here...
    Catch ex As System.Exception
        Dim e As GenericError = New GenericError( _
                                "cannot write file", ex)
        e.reason = "Exception during write operation"
        Throw e
    End Try
End Sub
```

Note that, for this example, we have supplied the optional second parameter to the `GenericError` constructor (see Section 14.10). This parameter sets the `InnerException` member of `System.Exception` and preserves the original cause of the error for later diagnosis.

If you throw an arbitrary VB run-time exception (such as an `InvalidCastException`), the Ice run time catches the exception and then returns an `UnknownException` to the client. Similarly, if you throw an “impossible” user exception (a user exception that is not listed in the exception specification of the operation), the client receives an `UnknownUserException`.

If you throw an Ice run-time exception, such `MemoryLimitException`, the client receives an `UnknownLocalException`.² For that reason, you should never

2. There are three run-time exceptions that are not changed to `UnknownLocalException` when returned to the client: `ObjectNotExistException`, `OperationNotExistException`, and `FacetNotExistException`. We discuss these exceptions in more detail in Chapter 33.

throw system exceptions from operation implementations. If you do, all the client will see is an `UnknownLocalException`, which does not tell the client anything useful.

20.7 Tie Classes

The mapping to skeleton classes we saw in Section 20.4 requires the servant class to inherit from its skeleton class. Occasionally, this creates a problem: some class libraries require you to inherit from a base class in order to access functionality provided by the library; because VB does not support multiple implementation inheritance, this means that you cannot use such a class library to implement your servants because your servants cannot inherit from both the library class and the skeleton class simultaneously.

To allow you to still use such class libraries, Ice provides a way to write servants that replaces inheritance with delegation. This approach is supported by *tie classes*. The idea is that, instead of inheriting from the skeleton class, you simply create a class (known as an *implementation class* or *delegate class*) that contains methods corresponding to the operations of an interface. You use the `--tie` option with the `slice2cs` compiler to create a tie class. For example, for the Node interface we saw in Section 20.4.1, the `--tie` option causes the compiler to create exactly the same code as we saw previously, but to also emit an additional tie class. For an interface `<interface-name>`, the generated tie class has the name `<interface-name>Tie_`:

```
Namespace Filesystem

    public class NodeTie_
        Inherits NodeDisp_
        Implements Ice.TieBase

        Public Sub New()
        End Sub

        Public Sub New(ByVal del As NodeOperations_)
            _ice_delegate = del
        End Sub

        Public Function ice_delegate() As Object _
            Implements Ice.TieBase.ice_delegate
            Return _ice_delegate
        End Function
    End Class
End Namespace
```



```

End Function

Public Sub ice_delegate(ByVal del As Object) _
    Implements Ice.TieBase.ice_delegate
    _ice_delegate = CType(del, NodeOperations_)
End Sub

Public Overrides Function ice_getHash() As Integer
    Return GetHashCode()
End Function

Public Overrides Function GetHashCode() As Integer
    If _ice_delegate Is Nothing Then
        Return 0
    Else
        Return CType(_ice_delegate, Object).GetHashCode()
    End If
End Function

Public Overloads Overrides Function Equals( _
    ByVal rhs As Object) As Boolean
    If Object.ReferenceEquals(Me, rhs) Then
        Return true
    End If
    If Not TypeOf rhs Is NodeTie_ Then
        Return False
    End If
    If _ice_delegate Is Nothing Then
        Return CType(rhs, NodeTie_)._ice_delegate _
            Is Nothing
    End If
    Return CType(_ice_delegate, Object)._
        Equals(CType(rhs, NodeTie_)._ice_delegate)
End Function

Public Overloads Overrides Function name( _
    ByVal __current As Ice.Current) As String
    Return _ice_delegate.name(__current)
End Function

Private _ice_delegate As NodeOperations_
End Class

```

This looks a lot worse than it is: in essence, the generated tie class is simply a servant class (it extends `NodeDisp_`) that delegates each invocation of a method

that corresponds to a Slice operation to your implementation class (see Figure 20.1).

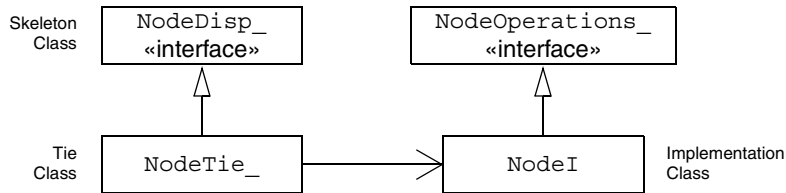

Figure 20.1. A skeleton class, tie class, and implementation class.

The `Ice.TieBase` interface defines the `ice_delegate` methods that allow you to get and set the delegate.

Given this machinery, we can create an implementation class for our `Node` interface as follows:

```
Imports Filesystem

Public Class NodeI
    Implements NodeOperations_

    Public Sub New(ByVal name As String)
        _name = name
    End Sub

    Public Function name(ByVal current As Ice.Current) _
        As String Implements NodeOperations_.name
        Return _name
    End Function

    Private _name As String

End Class
```

Note that this class is very similar to our previous implementation but, instead of inheriting from `NodeDisp_`, the class implements the `NodeOperations_` interface (which means that you are now free to extend any other class to support your implementation).

To create a servant, you instantiate your implementation class and the tie class, passing a reference to the implementation instance to the tie constructor:

```
Dim fred As NodeI = New NodeI("Fred") ' Create implementation
Dim servant As NodeTie_ = New NodeTie_(fred) ' Create tie
```

Alternatively, you can also default-construct the tie class and later set its delegate instance by calling `ice_delegate`:

```
Dim servant As NodeTie_ = New NodeTie_() ' Create tie
' ...
Dim fred As NodeI = New NodeI("Fred") ' Create implementation
' ...
servant.ice_delegate(fred) ' Set delegate
```

When using tie classes, it is important to remember that the tie instance is the servant, not your delegate. Furthermore, you must not use a tie instance to incarnate (see Section 20.8) an Ice object until the tie has a delegate. Once you have set the delegate, you must not change it for the lifetime of the tie; otherwise, undefined behavior results.

You should use the tie approach only if you need to, that is, if you need to extend some base class in order to implement your servants: using the tie approach is more costly in terms of memory because each Ice object is incarnated by two VB objects instead of one, the tie and the delegate. In addition, call dispatch for ties is marginally slower than for ordinary servants because the tie forwards each operation to the delegate, that is, each operation invocation requires two function calls instead of one.

Also note that, unless you arrange for it, there is no way to get from the delegate back to the tie. If you need to navigate back to the tie from the delegate, you can store a reference to the tie in a member of the delegate. (The reference can, for example, be initialized by the constructor of the delegate.)

20.8 Object Incarnation

Having created a servant class such as the rudimentary `NodeI` class in Section 20.4.2, you can instantiate the class to create a concrete servant that can receive invocations from a client. However, merely instantiating a servant class is insufficient to incarnate an object. Specifically, to provide an implementation of an Ice object, you must take the following steps:

1. Instantiate a servant class.
2. Create an identity for the Ice object incarnated by the servant.
3. Inform the Ice run time of the existence of the servant.
4. Pass a proxy for the object to a client so the client can reach it.

20.8.1 Instantiating a Servant

Instantiating a servant means to allocate an instance:

```
Dim servant As Node = New NodeI
```

This code creates a new `NodeI` instance and assigns its address to a reference of type `Node`. This works because `NodeI` is derived from `Node`, so a `Node` reference can refer to an instance of type `NodeI`. However, if we want to invoke a method of the `NodeI` class at this point, we must use a `NodeI` reference:

```
Dim servant As NodeI = New NodeI("Fred")
```

Whether you use a `Node` or a `NodeI` reference depends purely on whether you want to invoke a method of the `NodeI` class: if not, a `Node` reference works just as well as a `NodeI` reference.

20.8.2 Creating an Identity

Each Ice object requires an identity. That identity must be unique for all servants using the same object adapter.³ An Ice object identity is a structure with the following Slice definition:

```
module Ice {
    struct Identity {
        string name;
        string category;
    };
    // ...
};
```

The full identity of an object is the combination of both the name and category fields of the `Identity` structure. For now, we will leave the `category` field as the empty string and simply use the `name` field. (See Section 31.6 for a discussion of the `category` field.)

To create an identity, we simply assign a key that identifies the servant to the `name` field of the `Identity` structure:

```
Dim id As Ice.Identity = New Ice.Identity
id.name = "Fred" ' Not unique, but good enough for now
```

3. The Ice object model assumes that all objects (regardless of their adapter) have a globally unique identity. See XREF for further discussion.

20.8.3 Activating a Servant

Merely creating a servant instance does nothing: the Ice run time becomes aware of the existence of a servant only once you explicitly tell the object adapter about the servant. To activate a servant, you invoke the `add` operation on the object adapter. Assuming that we have access to the object adapter in the `_adapter` variable, we can write:

```
_adapter.add(servant, id)
```

Note the two arguments to `add`: the servant and the object identity. Calling `add` on the object adapter adds the servant and the servant's identity to the adapter's servant map and links the proxy for an Ice object to the correct servant instance in the server's memory as follows:

1. The proxy for an Ice object, apart from addressing information, contains the identity of the Ice object. When a client invokes an operation, the object identity is sent with the request to the server.
2. The object adapter receives the request, retrieves the identity, and uses the identity as an index into the servant map.
3. If a servant with that identity is active, the object adapter retrieves the servant from the servant map and dispatches the incoming request into the correct method on the servant.

Assuming that the object adapter is in the active state (see Section 31.4), client requests are dispatched to the servant as soon as you call `add`.

20.8.4 UUIDs as Identities

As we discussed in Section 2.5.1, the Ice object model assumes that object identities are globally unique. One way of ensuring that uniqueness is to use UUIDs (Universally Unique Identifiers) [14] as identities. The `Ice.Util` package contains a helper function to create such identities:

```
Module Example
```

```
    Public Sub Main(ByVal args As String())
        System.Console.WriteLine(Ice.Util.generateUUID())
    End Sub
```

```
End Module
```

When executed, this program prints a unique string such as `5029a22c-e333-4f87-86b1-cd5e0fcce509`. Each call to `generate-`

UUID creates a string that differs from all previous ones.⁴ You can use a UUID such as this to create object identities. For convenience, the object adapter has an operation `addWithUUID` that generates a UUID and adds a servant to the servant map in a single step. Using this operation, we can create an identity and register a servant with that identity in a single step as follows:

```
_adapter.addWithUUID(New NodeI("Fred"))
```

20.8.5 Creating Proxies

Once we have activated a servant for an Ice object, the server can process incoming client requests for that object. However, clients can only access the object once they hold a proxy for the object. If a client knows the server's address details and the object identity, it can create a proxy from a string, as we saw in our first example in Chapter 3. However, creation of proxies by the client in this manner is usually only done to allow the client access to initial objects for bootstrapping. Once the client has an initial proxy, it typically obtains further proxies by invoking operations.

The object adapter contains all the details that make up the information in a proxy: the addressing and protocol information, and the object identity. The Ice run time offers a number of ways to create proxies. Once created, you can pass a proxy to the client as the return value or as an out-parameter of an operation invocation.

Proxies and Servant Activation

The `add` and `addWithUUID` servant activation operations on the object adapter return a proxy for the corresponding Ice object. This means we can write:

```
Dim proxy As NodePrx = NodePrxHelper.uncheckedCast( _  
    _adapter.addWithUUID(New NodeI("Fred")))
```

Here, `addWithUUID` both activates the servant and returns a proxy for the Ice object incarnated by that servant in a single step.

Note that we need to use an `uncheckedCast` here because `addWithUUID` returns a proxy of type `Ice.ObjectPrx`.

4. Well, almost: eventually, the UUID algorithm wraps around and produces strings that repeat themselves, but this will not happen until approximately the year 3400.

Direct Proxy Creation

The object adapter offers an operation to create a proxy for a given identity:

```
module Ice {
    local interface ObjectAdapter {
        Object* createProxy(Identity id);
        // ...
    };
};
```

Note that `createProxy` creates a proxy for a given identity whether a servant is activated with that identity or not. In other words, proxies have a life cycle that is quite independent from the life cycle of servants:

```
Dim id As Ice.Identity = New Ice.Identity
id.name = Ice.Util.generateUUID()
Dim o As Ice.ObjectPrx = _adapter.createProxy(id)
```

This creates a proxy for an Ice object with the identity returned by `generateUUID`. Obviously, no servant yet exists for that object so, if we return the proxy to a client and the client invokes an operation on the proxy, the client will receive an `ObjectNotExistException`. (We examine these life cycle issues in more detail in XREF.)

20.9 Summary

This chapter presented the server-side VB mapping. Because the mapping for Slice data types is identical for clients and servers, the server-side mapping only adds a few additional mechanisms to the client side: a small API to initialize and finalize the run time, plus a few rules for how to derive servant classes from skeletons and how to register servants with the server-side run time.

Even though the examples in this chapter are very simple, they accurately reflect the basics of writing an Ice server. Of course, for more sophisticated servers (which we discuss in Chapter 31), you will be using additional APIs, for example, to improve performance or scalability. However, these APIs are all described in Slice, so, to use these APIs, you need not learn any VB mapping rules beyond those we described here.

Chapter 21

Developing a File System Server in Visual Basic

21.1 Chapter Overview

In this chapter, we present the source code for a VB server that implements the file system we developed in Chapter 5 (see Chapter 19 for the corresponding client). The code we present here is fully functional, apart from the required interlocking for threads. (We examine threading issues in detail in Section 31.9.)

21.2 Implementing a File System Server

We have now seen enough of the server-side VB mapping to implement a server for the file system we developed in Chapter 5. (You may find it useful to review the Slice definition for our file system in Section 5.3 before studying the source code.)

Our server is composed of three source files:

- `Server.vb`

This file contains the server main program.

- `DirectoryI.vb`

This file contains the implementation for the Directory servants.

- FileI.vb

This file contains the implementation for the File servants.

21.2.1 The Server Main Program

Our server main program, in the file `Server.vb`, uses the `Ice.Application` class we discussed in Section 16.3.1. The `run` method installs a signal handler, creates an object adapter, instantiates a few servants for the directories and files in the file system, and then activates the adapter. This leads to a `Main` function as follows:

```
Imports System
Imports FileSystem

Module Server

    Public Class Server
        Inherits Ice.Application

        Public Overrides Function run(ByVal args As String()) _
            As Integer
            ' Terminate cleanly on receipt of a signal
            '
            shutdownOnInterrupt()

            ' Create an object adapter (stored in the _adapter
            ' static members)
            '
            Dim adapter As Ice.ObjectAdapter = _
                communicator().createObjectAdapterWithEndpoints( _
                    "SimpleFilesystem", "default -p 10000")
            DirectoryI._adapter = adapter
            FileI._adapter = adapter

            ' Create the root directory (with name "/"
            ' and no parent)
            '
            Dim root As DirectoryI = New DirectoryI("/", Nothing)

            ' Create a file called "README" in the root directory
            '
            Dim file As FileI = New FileI("README", root)
            Dim text As String() = New String() _
                {"This file system contains " _
```

```
        & "a collection of poetry."}
    Try
        file.write(text)
    Catch e As GenericError
        Console.Error.WriteLine(e.reason)
    End Try

    ' Create a directory called "Coleridge"
    ' in the root directory
    '
    Dim coleridge As DirectoryI = _
        New DirectoryI("Coleridge", root)

    ' Create a file called "Kubla_Khan"
    ' in the Coleridge directory
    '
    file = New FileI("Kubla_Khan", coleridge)
    text = New String() {"In Xanadu did Kubla Khan", _
        "A stately pleasure-dome decree:", _
        "Where Alph, the sacred river, ran", _
        "Through caverns measureless to man", _
        "Down to a sunless sea."}
    Try
        file.write(text)
    Catch e As GenericError
        Console.Error.WriteLine(e.reason)
    End Try

    ' All objects are created, allow client requests now
    '
    adapter.activate()

    ' Wait until we are done
    '
    communicator().waitForShutdown()

    If interrupted() Then
        Console.Error.WriteLine(appName() _
            & ": terminating")
    End If

    Return 0
End Function

End Class
```

```

Public Sub Main(ByVal args As String())
    Dim app As Server = New Server
    Environment.Exit(app.Main(args))
End Sub

```

End Module

The code uses an `Imports` statement for the the `Filesystem` namespace. This avoids having to continuously use fully-qualified identifiers with a `Filesystem.` prefix.

The next part of the source code is the definition of the `Server` class, which derives from `Ice.Application` and contains the main application logic in its `run` method. Much of this code is boiler plate that we saw previously: we create an object adapter, and, towards the end, activate the object adapter and call `wait-ForShutdown`.

The interesting part of the code follows the adapter creation: here, the server instantiates a few nodes for our file system to create the structure shown in Figure 21.1.

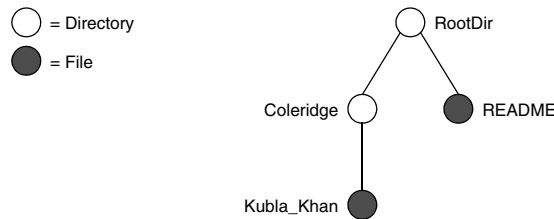

Figure 21.1. A small file system.

As we will see shortly, the servants for our directories and files are of type `DirectoryI` and `FileI`, respectively. The constructor for either type of servant accepts two parameters, the name of the directory or file to be created and a reference to the servant for the parent directory. (For the root directory, which has no parent, we pass a `Nothing` parent.) Thus, the statement

```
Dim root As DirectoryI = New DirectoryI("/", Nothing)
```

creates the root directory, with the name `" / "` and no parent directory.

Here is the code that establishes the structure in Figure 21.1:

```

' Create the root directory (with name
' "/" and no parent)
'
Dim root As DirectoryI = New DirectoryI("/", Nothing)

```

```
' Create a file called "README" in the root directory
'
Dim file As FileI = New FileI("README", root)
Dim text As String() = New String() _
    {"This file system contains " _
     & "a collection of poetry."}
Try
    file.write(text)
Catch e As GenericError
    Console.Error.WriteLine(e.reason)
End Try

' Create a directory called "Coleridge"
' in the root directory
'
Dim coleridge As DirectoryI = _
    New DirectoryI("Coleridge", root)

' Create a file called "Kubla_Khan"
' in the Coleridge directory
'
file = New FileI("Kubla_Khan", coleridge)
text = New String() {"In Xanadu did Kubla Khan", _
    "A stately pleasure-dome decree:", _
    "Where Alph, the sacred river, ran", _
    "Through caverns measureless to man", _
    "Down to a sunless sea."}
Try
    file.write(text)
Catch e As GenericError
    Console.Error.WriteLine(e.reason)
End Try
```

We first create the root directory and a file README within the root directory. (Note that we pass a reference to the root directory as the parent when we create the new node of type FileI.)

The next step is to fill the file with text:

```
Dim text As String() = New String() _
    {"This file system contains " _
     & "a collection of poetry."}
Try
```

```

        file.write(text)
    Catch e As GenericError
        Console.Error.WriteLine(e.reason)
    End Try

```

Recall from Section 18.7.3 that `Slice` sequences by default map to VB arrays. The `Slice` type `Lines` is simply an array of strings; we add a line of text to our `README` file by initializing the `text` array to contain one element.

Finally, we call the `Slice` write operation on our `FileI` servant by simply writing:

```
file.write(text)
```

This statement is interesting: the server code invokes an operation on one of its own servants. Because the call happens via a reference to the servant (of type `FileI`) and *not* via a proxy (of type `FilePrx`), the Ice run time does not know that this call is even taking place—such a direct call into a servant is not mediated by the Ice run time in any way and is dispatched as an ordinary VB method call.

In similar fashion, the remainder of the code creates a subdirectory called `Coleridge` and, within that directory, a file called `Kubla_Khan` to complete the structure in Figure 21.1.

21.2.2 The `FileI` Servant Class

Our `FileI` servant class has the following basic structure:

```

Imports System
Imports System.Diagnostics
Imports Filesystem

Public Class FileI
    Inherits FileDisp_

    ' Constructor and operations here...

    Public Shared _adapter As Ice.ObjectAdapter
    Private _name As String
    Private _parent As DirectoryI
    Private _lines As String()

End Class

```

The class has a number of data members:

- `_adapter`
This static member stores a reference to the single object adapter we use in our server.
- `_name`
This member stores the name of the file incarnated by the servant.
- `_parent`
This member stores the reference to the servant for the file's parent directory.
- `_lines`
This member holds the contents of the file.

The `_name` and `_parent` data members are initialized by the constructor:

```
Public Sub New(ByVal name As String, _
              ByVal parent As DirectoryI)
    _name = name
    _parent = parent

    Debug.Assert(Not _parent Is Nothing)

    ' Create an identity
    '
    Dim myId As Ice.Identity = _
        Ice.Util.stringToIdentity(Ice.Util.generateUUID())

    ' Add the identity to the object adapter
    '
    _adapter.add(Me, myId)

    ' Create a proxy for the new node and
    ' add it as a child to the parent
    '
    Dim thisNode As NodePrx _
        = NodePrxHelper.uncheckedCast( _
            _adapter.createProxy(myId))
    _parent.addChild(thisNode)
End Sub
```

After initializing the `_name` and `_parent` members, the code verifies that the reference to the parent is not `Nothing` because every file must have a parent directory. The constructor then generates an identity for the file by calling `Ice.Util.generateUUID` and adds itself to the servant map by calling `ObjectAdapter.add`. Finally, the constructor creates a proxy for this file and

calls the `addChild` method on its parent directory. `addChild` is a helper function that a child directory or file calls to add itself to the list of descendant nodes of its parent directory. We will see the implementation of this function on page 572.

The remaining methods of the `FileI` class implement the `Slice` operations we defined in the `Node` and `File` `Slice` interfaces:

```
' Slice Node::name() operation

Public Overloads Overrides Function name( _
    ByVal current As Ice.Current) As String
    Return _name
End Function

' Slice File::read() operation

Public Overloads Overrides Function read( _
    ByVal current As Ice.Current) As String()
    Return _lines
End Function

' Slice File::write() operation

Public Overloads Overrides Sub write( _
    ByVal text As String(), _
    ByVal current As Ice.Current)
    _lines = text
End Sub
```

The `name` method is inherited from the generated `Node` interface (which is a base interface of the `_FileDisp` class from which `FileI` is derived). It simply returns the value of the `_name` member.

The `read` and `write` methods are inherited from the generated `File` interface (which is a base interface of the `_FileDisp` class from which `FileI` is derived) and simply return and set the `_lines` member.

21.2.3 The DirectoryI Servant Class

The `DirectoryI` class has the following basic structure:

```
Imports System
Imports System.Collections
Imports Filesystem
```



```

Public Class DirectoryI
    Inherits DirectoryDisp_

    ' Constructor and operations here...

    Public Shared _adapter As Ice.ObjectAdapter
    Private _name As String
    Private _parent As DirectoryI
    Private _contents As ArrayList = New ArrayList

End Class

```

As for the `FileI` class, we have data members to store the object adapter, the name, and the parent directory. (For the root directory, the `_parent` member holds a `Nothing` reference.) In addition, we have a `_contents` data member that stores the list of child directories. These data members are initialized by the constructor:

```

Public Sub New(ByVal name As String, _
               ByVal parent As DirectoryI)
    _name = name
    _parent = parent

    ' Create an identity. The
    ' parent has the fixed identity "RootDir"
    '
    Dim myId As Ice.Identity
    If Not _parent Is Nothing Then
        myId = Ice.Util.stringToIdentity( _
            Ice.Util.generateUUID())
    Else
        myId = Ice.Util.stringToIdentity("RootDir")
    End If

    ' Add the identity to the object adapter
    '
    _adapter.add(Me, myId)

    ' Create a proxy for the new node and
    ' add it as a child to the parent
    '
    Dim thisNode As NodePrx _
        = NodePrxHelper.uncheckedCast( _
            _adapter.createProxy(myId))

```

```

        If Not _parent Is Nothing Then
            _parent.addChild(thisNode)
        End If
    End Sub

```

The constructor creates an identity for the new directory by calling `Ice.Util.generateUUID`. (For the root directory, we use the fixed identity "RootDir".) The servant adds itself to the servant map by calling `ObjectAdapter.add` and then creates a proxy to itself and passes it to the `addChild` helper function.

`addChild` simply adds the passed reference to the `_contents` list:

```

    Public Sub addChild(ByVal child As NodePrx)
        _contents.Add(child)
    End Sub

```

The remainder of the operations, `name` and `list`, are trivial:

```

    Public Overloads Overrides Function name( _
        ByVal current As Ice.Current) As String
        Return _name
    End Function

    Public Overloads Overrides Function list( _
        ByVal current As Ice.Current) As NodePrx()
        Return CType(_contents.ToArray( _
            GetType(NodePrx)), NodePrx())
    End Function

```

Note that the `_contents` member is of type `System.Collections.ArrayList`, which is convenient for the implementation of the `addChild` method. However, this requires us to convert the list into a VB array in order to return it from the `list` operation.

21.3 Summary

This chapter showed how to implement a complete server for the file system we defined in Chapter 5. Note that the server is remarkably free of code that relates to distribution: most of the server code is simply application logic that would be present just the same for a non-distributed version. Again, this is one of the major advantages of Ice: distribution concerns are kept away from application code so that you can concentrate on developing application logic instead of networking infrastructure.

Note that the server code we presented here is not quite correct as it stands: if two clients access the same file in parallel, each via a different thread, one thread may read the `_lines` data member while another thread updates it. Obviously, if that happens, we may write or return garbage or, worse, crash the server. However, it is trivial to make the `read` and `write` operations thread-safe. We discuss thread safety in Section 31.9.

Part III.E

Python Mapping

Chapter 22

Client-Side Slice-to-Python Mapping

22.1 Chapter Overview

In this chapter, we present the client-side Slice-to-Python mapping (see Chapter 24 for the server-side mapping). One part of the client-side Python mapping concerns itself with rules for representing each Slice data type as a corresponding Python type; we cover these rules in Section 22.3 to Section 22.10. Another part of the mapping deals with how clients can invoke operations, pass and receive parameters, and handle exceptions. These topics are covered in Section 22.11 to Section 22.13. Slice classes have the characteristics of both data types and interfaces and are covered in Section 22.14. Code generation issues are discussed in Section 22.15, while Section 22.16 addresses the use of Slice checksums.

22.2 Introduction

The client-side Slice-to-Python mapping defines how Slice data types are translated to Python types, and how clients invoke operations, pass parameters, and handle errors. Much of the Python mapping is intuitive. For example, Slice sequences map to Python lists, so there is essentially nothing new you have learn in order to use Slice sequences in Python.

The Python API to the Ice run time is fully thread-safe. Obviously, you must still synchronize access to data from different threads. For example, if you have two threads sharing a sequence, you cannot safely have one thread insert into the sequence while another thread is iterating over the sequence. However, you only need to concern yourself with concurrent access to your own data—the Ice run time itself is fully thread safe, and none of the Ice API calls require you to acquire or release a lock before you safely can make the call.

Much of what appears in this chapter is reference material. We suggest that you skim the material on the initial reading and refer back to specific sections as needed. However, we recommend that you read at least Section 22.11 to Section 22.13 in detail because these sections cover how to call operations from a client, pass parameters, and handle exceptions.

A word of advice before you start: in order to use the Python mapping, you should need no more than the Slice definition of your application and knowledge of the Python mapping rules. In particular, looking through the generated code in order to discern how to use the Python mapping is likely to be inefficient, due to the amount of detail. Of course, occasionally, you may want to refer to the generated code to confirm a detail of the mapping, but we recommend that you otherwise use the material presented here to see how to write your client-side code.

22.3 Mapping for Identifiers

Slice identifiers map to an identical Python identifier. For example, the Slice identifier `Clock` becomes the Python identifier `Clock`. There is one exception to this rule: if a Slice identifier is the same as a Python keyword, the corresponding Python identifier is prefixed with an underscore. For example, the Slice identifier `while` is mapped as `_while`.¹

The mapping does not modify a Slice identifier that matches the name of a Python built-in function because it can always be accessed by its fully-qualified name. For example, the built-in function `hash` can also be accessed as `__builtin__.hash`.

1. As suggested in Section 4.5.3 on page 86, you should try to avoid such identifiers as much as possible.

22.4 Mapping for Modules

Slice modules map to Python modules with the same name as the Slice module. The mapping preserves the nesting of the Slice definitions. See Section 22.15.2 for information about the mapping's use of Python packages.

22.5 The `Ice` Module

All of the APIs for the Ice run time are nested in the `Ice` module, to avoid clashes with definitions for other libraries or applications. Some of the contents of the `Ice` module are generated from Slice definitions; other parts of the `Ice` module provide special-purpose definitions that do not have a corresponding Slice definition. We will incrementally cover the contents of the `Ice` module throughout the remainder of the book.

22.6 Mapping for Simple Built-In Types

The Slice built-in types are mapped to Python types as shown in Table 22.1.

Table 22.1. Mapping of Slice built-in types to Python.

Slice	Python
<code>bool</code>	<code>bool</code>
<code>byte</code>	<code>int</code>
<code>short</code>	<code>int</code>
<code>int</code>	<code>int</code>
<code>long</code>	<code>long</code>
<code>float</code>	<code>double</code>
<code>double</code>	<code>double</code>

Table 22.1. Mapping of Slice built-in types to Python.

Slice	Python
string	string

Although Python supports arbitrary precision in its integer types, the Ice run time validates integer values to ensure they have valid ranges for their declared Slice types.

22.7 Mapping for User-Defined Types

Slice supports user-defined types: enumerations, structures, sequences, and dictionaries.

22.7.1 Mapping for Enumerations

Python does not have an enumerated type, so the Slice enumerations are emulated using a Python class: the name of the Slice enumeration becomes the name of the Python class; for each enumerator, the class contains an attribute with the same name as the enumerator. For example:

```
enum Fruit { Apple, Pear, Orange };
```

The generated Python class looks as follows:

```
class Fruit(object):
    def __init__(self, val):
        assert(val >= 0 and val < 3)
        self.value = val

    # ...

Fruit.Apple = Fruit(0)
Fruit.Pear = Fruit(1)
Fruit.Orange = Fruit(2)
```

Each instance of the class has a `value` attribute providing the integer value of the enumerator. Note that the generated class also defines a number of Python special methods, such as `__str__` and `__cmp__`, which we have not shown.

Given the above definitions, we can use enumerated values as follows:

```
f1 = Fruit.Apple
f2 = Fruit.Orange

if f1 == Fruit.Apple:           # Compare with constant
    # ...

if f1 == f2:                   # Compare two enums
    # ...

if f2.value == Fruit.Apple.value: # Use integer values
    # ...
elif f2.value == Fruit.Pear.value:
    # ...
elif f2.value == Fruit.Orange.value:
    # ...
```

As you can see, the generated class enables natural use of enumerated values. The `Fruit` class attributes are preinitialized enumerators that you can use for initialization and comparison. You may also instantiate an enumerator explicitly by passing its integer value to the constructor, but you must make sure that the passed value is within the range of the enumeration; failure to do so will result in an assertion failure:

```
favoriteFruit = Fruit(4) # Assertion failure!
```

22.7.2 Mapping for Structures

Slice structures map to Python classes with the same name. For each Slice data member, the Python class contains a corresponding attribute. For example, here is our `Employee` structure from Section 4.9.4 once more:

```
struct Employee {
    long number;
    string firstName;
    string lastName;
};
```

The Python mapping generates the following definition for this structure:

```
class Employee(object):
    def __init__(self, number=0, firstName='', lastName=''):
        self.number = number
        self.firstName = firstName
        self.lastName = lastName
```

The constructor initializes each of the attributes to a default value appropriate for its type.

22.7.3 Mapping for Sequences

Slice sequences map to Python lists. This means that the Python mapping does not generate a separate named type for a Slice sequence. It also means that you can take advantage of all the list functionality provided by Python. For example:

```
sequence<Fruit> FruitPlatter;
```

We can use the `FruitPlatter` sequence as shown below:

```
platter = [ Fruit.Apple, Fruit.Pear ]
assert (len(platter) == 2)
platter.append(Fruit.Orange)
```

The Python mapping also allows a sender to use a tuple instead of a list, but the receiver always receives a list.

The Ice run time validates the elements of a sequence to ensure that they are compatible with the declared type; a `ValueError` exception is raised if an incompatible type is encountered.

22.7.4 Mapping for Dictionaries

Here is the definition of our `EmployeeMap` from Section 4.9.4 once more:

```
dictionary<long, Employee> EmployeeMap;
```

As for sequences, the Python mapping does not create a separate named type for this definition. Instead, *all* dictionaries are simply instances of Python's dictionary type. For example:

```
em = {}

e = Employee()
e.number = 31
```

```
e.firstName = "James"  
e.lastName = "Gosling"
```

```
em[e.number] = e
```

The Ice run time validates the elements of a dictionary to ensure that they are compatible with the declared type; a `ValueError` exception is raised if an incompatible type is encountered.

22.8 Mapping for Constants

Here are the constant definitions we saw in Section 4.9.5 on page 97 once more:

```
const bool      AppendByDefault = true;  
const byte      LowerNibble = 0x0f;  
const string    Advice = "Don't Panic!";  
const short     TheAnswer = 42;  
const double    PI = 3.1416;
```

```
enum Fruit { Apple, Pear, Orange };  
const Fruit    FavoriteFruit = Pear;
```

The generated definitions for these constants are shown below:

```
AppendByDefault = True  
LowerNibble = 15  
Advice = "Don't Panic!"  
TheAnswer = 42  
PI = 3.1416  
FavoriteFruit = Fruit.Pear
```

As you can see, each Slice constant is mapped to a Python attribute with the same name as the constant.

22.9 Mapping for Exceptions

The mapping for exceptions is based on the inheritance hierarchy shown in Figure 22.1

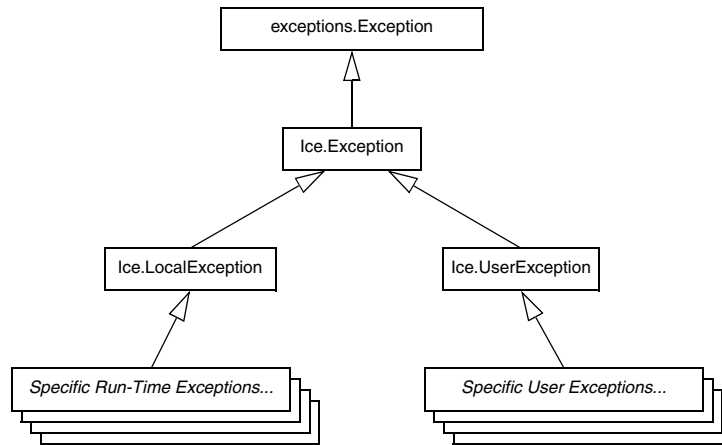

Figure 22.1. Inheritance structure for Ice exceptions.

The ancestor of all exceptions is `exceptions.Exception`, from which `Ice.Exception` is derived. `Ice.LocalException` and `Ice.UserException` are derived from `Ice.Exception` and form the base for all run-time and user exceptions.

Here is a fragment of the Slice definition for our world time server from Section 4.10.5 on page 113 once more:

```

exception GenericError {
    string reason;
};
exception BadTimeVal extends GenericError {};
exception BadZoneName extends GenericError {};
  
```

These exception definitions map as follows:

```

class GenericError(Ice.UserException):
    def __init__(self, reason=''):
        self.reason = reason

    def ice_name(self):
        # ...
  
```

```
def __str__(self):
    # ...

class BadTimeVal(GenericError):
    def __init__(self, reason=''):
        GenericError.__init__(self, reason)

    def ice_name(self):
        # ...

    def __str__(self):
        # ...

class BadZoneName(GenericError):
    def __init__(self, reason=''):
        GenericError.__init__(self, reason)

    def ice_name(self):
        # ...

    def __str__(self):
        # ...
```

Each Slice exception is mapped to a Python class with the same name. The inheritance structure of the Slice exceptions is preserved for the generated classes, so `BadTimeVal` and `BadZoneName` inherit from `GenericError`.

Each exception member corresponds to an attribute of the instance, which the constructor initializes to a default value appropriate for its type. Although `BadTimeVal` and `BadZoneName` do not declare data members, their constructors still accept a value for the inherited data member `reason` in order to pass it to the constructor of the base exception `GenericError`.

Each exception also defines the `ice_name` method to return the name of the exception, and the special method `__str__` to return a stringified representation of the exception and its members.

All user exceptions are derived from the base class `Ice.UserException`. This allows you to catch all user exceptions generically by installing a handler for `Ice.UserException`. Similarly, you can catch all Ice run-time exceptions with a handler for `Ice.LocalException`, and you can catch all Ice exceptions with a handler for `Ice.Exception`.

22.10 Mapping for Run-Time Exceptions

The Ice run time throws run-time exceptions for a number of pre-defined error conditions. All run-time exceptions directly or indirectly derive from `Ice.LocalException` (which, in turn, derives from `Ice.Exception`).

An inheritance diagram for user and run-time exceptions appears in Figure 4.4 on page 110. By catching exceptions at the appropriate point in the hierarchy, you can handle exceptions according to the category of error they indicate:

- `Ice.LocalException`
This is the root of the inheritance tree for run-time exceptions.
- `Ice.UserException`
This is the root of the inheritance tree for user exceptions.
- `Ice.TimeoutException`
This is the base exception for both operation-invocation and connection-establishment timeouts.
- `Ice.ConnectTimeoutException`
This exception is raised when the initial attempt to establish a connection to a server times out.

You will probably have little need to catch the remaining exceptions by category; the fine-grained error handling offered by the remainder of the hierarchy is of interest mainly in the implementation of the Ice run time. However, there is one exception you will probably be interested in specifically:

`Ice.ObjectNotExistException`. This exception is raised if a client invokes an operation on an Ice object that no longer exists. In other words, the client holds a dangling reference to an object that probably existed some time in the past but has since been permanently destroyed.

22.11 Mapping for Interfaces

The mapping of Slice interfaces revolves around the idea that, to invoke a remote operation, you call a method on a local class instance that represents the remote object. This makes the mapping easy and intuitive to use because, for all intents and purposes (apart from error semantics), making a remote procedure call is no different from making a local procedure call.

22.11.1 Proxy Classes

On the client side, Slice interfaces map to Python classes with methods that correspond to the operations on those interfaces. Consider the following simple interface:

```
interface Simple {
    void op();
};
```

The Python mapping generates the following definition for use by the client:

```
class SimplePrx(Ice.ObjectPrx):
    def op(self, _ctx=None):
        # ...

    # ...
```

In the client's address space, an instance of `SimplePrx` is the local ambassador for a remote instance of the `Simple` interface in a server and is known as a *proxy instance*. All the details about the server-side object, such as its address, what protocol to use, and its object identity are encapsulated in that instance.

Note that `SimplePrx` inherits from `Ice.ObjectPrx`. This reflects the fact that all Ice interfaces implicitly inherit from `Ice::Object`.

For each operation in the interface, the proxy class has a method of the same name. In the preceding example, we find that the operation `op` has been mapped to the method `op`. Note that `op` accepts an optional trailing parameter `_ctx` representing the operation context. This parameter is a Python dictionary for use by the Ice run time to store information about how to deliver a request. You normally do not need to use it. (We examine the context parameter in detail in Chapter 31. The parameter is also used by `IceStorm`—see Chapter 43.)

Proxy instances are always created on behalf of the client by the Ice run time, so client code never has any need to instantiate a proxy directly.

22.11.2 The `Ice.ObjectPrx` Class

All Ice objects have `Object` as the ultimate ancestor type, so all proxies inherit from `Ice.ObjectPrx`. `ObjectPrx` provides a number of methods:

```
class ObjectPrx(object):
    def equals(self, other):
    def ice_getIdentity(self):
    def ice_getHash(self):
```

```

def ice_isA(self, id):
def ice_id(self):
def ice_ping(self):
# ...

```

The methods behave as follows:

- `equals`

This operation compares two proxies for equality. Note that all aspects of proxies are compared by this operation, such as the communication endpoints for the proxy. This means that, in general, if two proxies compare unequal, that does *not* imply that they denote different objects. For example, if two proxies denote the same Ice object via different transport endpoints, `equals` returns `false` even though the proxies denote the same object.

- `ice_getIdentity`

This method returns the identity of the object denoted by the proxy. The identity of an Ice object has the following Slice type:

```

module Ice {
    struct Identity {
        string name;
        string category;
    };
};

```

To see whether two proxies denote the same object, first obtain the identity for each object and then compare the identities:

```

proxy1 = ...
proxy2 = ...
id1 = proxy1.ice_getIdentity()
id2 = proxy2.ice_getIdentity()

if id1 == id2:
    # proxy1 and proxy2 denote the same object
else:
    # proxy1 and proxy2 denote different objects

```

- `ice_getHash`

This method returns an integer hash key for the proxy.

- `ice_isA`

This method determines whether the object denoted by the proxy supports a specific interface. The argument to `ice_isA` is a type ID (see Section 4.13).

For example, to see whether a proxy of type `ObjectPrx` denotes a `Printer` object, we can write:

```
proxy = ...
if proxy != None and proxy.ice_isA("::Printer"):
    # proxy denotes a Printer object
else:
    # proxy denotes some other type of object
```

Note that we are testing whether the proxy is `None` before attempting to invoke the `ice_isA` method. This avoids getting a run-time error if the proxy is `None`.

- `ice_id`

This method returns the type ID of the object denoted by the proxy. Note that the type returned is the type of the actual object, which may be more derived than the static type of the proxy. For example, if we have a proxy of type `BasePrx`, with a static type ID of `::Base`, the return value of `ice_id` might be `::Base`, or it might be something more derived, such as `::Derived`.

- `ice_ping`

This method provides a basic reachability test for the object. If the object can physically be contacted (that is, the object exists and its server is running and reachable), the call completes normally; otherwise, it throws an exception that indicates why the object could not be reached, such as

`ObjectNotExistException` or `ConnectTimeoutException`.

Note that there are other methods in `ObjectPrx`, not shown here. These methods provide different ways to dispatch a call. (We discuss these methods in Chapter 31.)

22.11.3 Casting Proxies

The Python mapping for a proxy also generates two static methods:

```
class SimplePrx(Ice.ObjectPrx):
    # ...

    def checkedCast(proxy, facet=''):
        # ...
    checkedCast = staticmethod(checkedCast)
```

```
def uncheckedCast(proxy, facet=''):
    # ...
uncheckedCast = staticmethod(uncheckedCast)
```

Both the `checkedCast` and `uncheckedCast` methods implement a down-cast: if the passed proxy is a proxy for an object of type `Simple`, or a proxy for an object with a type derived from `Simple`, the cast returns a reference to a proxy of type `SimplePrx`; otherwise, if the passed proxy denotes an object of a different type (or if the passed proxy is `None`), the cast returns `None`.

The method names `checkedCast` and `uncheckedCast` are reserved for use in proxies. If a Slice interface defines an operation with either of those names, the mapping escapes the name in the generated proxy by prepending an underscore. For example, an interface that defines an operation named `checkedCast` is mapped to a proxy with a method named `_checkedCast`.

Given a proxy of any type, you can use a `checkedCast` to determine whether the corresponding object supports a given type, for example:

```
obj = ...          # Get a proxy from somewhere...

simple = SimplePrx.checkedCast(obj)
if simple != None:
    # Object supports the Simple interface...
else:
    # Object is not of type Simple...
```

Note that a `checkedCast` contacts the server. This is necessary because only the implementation of a proxy in the server has definite knowledge of the type of an object. As a result, a `checkedCast` may throw a `ConnectTimeoutException` or an `ObjectNotExistException`.

In contrast, an `uncheckedCast` does not contact the server and unconditionally returns a proxy of the requested type. However, if you do use an `uncheckedCast`, you must be certain that the proxy really does support the type you are casting to; otherwise, if you get it wrong, you will most likely get a run-time exception when you invoke an operation on the proxy. The most likely error for such a type mismatch is `OperationNotExistException`. However, other exceptions, such as a marshaling exception are possible as well. And, if the object happens to have an operation with the correct name, but different parameter types, no exception may be reported at all and you simply end up sending the invocation to an object of the wrong type; that object may do rather non-sensical things. To illustrate this, consider the following two interfaces:

```

interface Process {
    void launch(int stackSize, int dataSize);
};

// ...

interface Rocket {
    void launch(float xCoord, float yCoord);
};

```

Suppose you expect to receive a proxy for a `Process` object and use an `uncheckedCast` to down-cast the proxy:

```

obj = ... # Get proxy...
process = ProcessPrx.uncheckedCast(obj) # No worries...
process.launch(40, 60) # Oops...

```

If the proxy you received actually denotes a `Rocket` object, the error will go undetected by the Ice run time: because `int` and `float` have the same size and because the Ice protocol does not tag data with its type on the wire, the implementation of `Rocket::launch` will simply misinterpret the passed integers as floating-point numbers.

In fairness, this example is somewhat contrived. For such a mistake to go unnoticed at run time, both objects must have an operation with the same name and, in addition, the run-time arguments passed to the operation must have a total marshaled size that matches the number of bytes that are expected by the unmarshaling code on the server side. In practice, this is extremely rare and an incorrect `uncheckedCast` typically results in a run-time exception.

22.12 Mapping for Operations

As we saw in Section 22.11, for each operation on an interface, the proxy class contains a corresponding method with the same name. To invoke an operation, you call it via the proxy. For example, here is part of the definitions for our file system from Section 5.4:

```

module Filesystem {
    interface Node {
        nonmutating string name();
    };
    // ...
};

```

The name operation returns a value of type string. Given a proxy to an object of type Node, the client can invoke the operation as follows:

```
node = ...           # Initialize proxy
name = node.name()  # Get name via RPC
```

22.12.1 Normal, idempotent, and nonmutating Operations

You can add an `idempotent` or `nonmutating` qualifier to a Slice operation. As far as the signature for the corresponding proxy methods is concerned, neither `idempotent` nor `nonmutating` have any effect. For example, consider the following interface:

```
interface Example {
    string op1();
    idempotent string op2();
    nonmutating string op3();
};
```

The proxy class for this is:

```
class ExamplePrx(Ice.ObjectPrx):
    def op1(self, _ctx=None):
        # ...

    def op2(self, _ctx=None):
        # ...

    def op3(self, _ctx=None):
        # ...
```

`idempotent` and `nonmutating` affect an aspect of call dispatch, not interface, so it makes sense for the three methods to look the same.

22.12.2 Passing Parameters

In Parameters

All parameters are passed by reference in the Python mapping; it is guaranteed that the value of a parameter will not be changed by the invocation.

Here is an interface with operations that pass parameters of various types from client to server:

```

struct NumberAndString {
    int x;
    string str;
};

sequence<string> StringSeq;

dictionary<long, StringSeq> StringTable;

interface ClientToServer {
    void op1(int i, float f, bool b, string s);
    void op2(NumberAndString ns, StringSeq ss, StringTable st);
    void op3(ClientToServer* proxy);
};

```

The Slice compiler generates the following proxy for this definition:

```

class ClientToServerPrx(Ice.ObjectPrx) :
    def op1(self, i, f, b, s, _ctx=None):
        # ...

    def op2(self, ns, ss, st, _ctx=None):
        # ...

    def op3(self, proxy, _ctx=None):
        # ...

```

Given a proxy to a `ClientToServer` interface, the client code can pass parameters as in the following example:

```

p = ... # Get proxy...

p.op1(42, 3.14f, true, "Hello world!") # Pass simple literals

i = 42
f = 3.14f
b = True
s = "Hello world!"
p.op1(i, f, b, s) # Pass simple variables

ns = NumberAndString()
ns.x = 42
ns.str = "The Answer"
ss = [ "Hello world!" ]
st = {}

```

```

st[0] = ns
p.op2(ns, ss, st)                                # Pass complex variables

p.op3(p)                                         # Pass proxy

```

Out Parameters

As in Java, Python functions do not support reference arguments. That is, it is not possible to pass an uninitialized variable to a Python function in order to have its value initialized by the function. The Java mapping (see Section 10.12.2) overcomes this limitation with the use of “holder classes” that represent each out parameter. The Python mapping takes a different approach, one that is more natural for Python users.

The semantics of out parameters in the Python mapping depend on whether the operation returns one value or multiple values. An operation returns multiple values when it has declared multiple out parameters, or when it has declared a non-void return type and at least one out parameter.

If an operation returns multiple values, the client receives them in the form of a *result tuple*. A non-void return value, if any, is always the first element in the result tuple, followed by the out parameters in the order of declaration.

If an operation returns only one value, the client receives the value itself.

Here is the same Slice definition we saw on page 592 once more, but this time with all parameters being passed in the out direction:

```

struct NumberAndString {
    int x;
    string str;
};

sequence<string> StringSeq;

dictionary<long, StringSeq> StringTable;

interface ClientToServer {
    int op1(out float f, out bool b, out string s);
    void op2(out NumberAndString ns,
             out StringSeq ss,
             out StringTable st);
    void op3(out ClientToServer* proxy);
};

```

The Python mapping generates the following code for this definition:

```
class ClientToServerPrx(Ice.ObjectPrx):
    def op1(self, _ctx=None):
        # ...

    def op2(self, _ctx=None):
        # ...

    def op3(self, _ctx=None):
        # ...
```

Given a proxy to a `ServerToClient` interface, the client code can receive the results as in the following example:

```
p = ... # Get proxy...
i, f, b, s = p.op1()
ns, ss, st = p.op2()
stcp = p.op3()
```

The operations have no `in` parameters, therefore no arguments are passed to the proxy methods. Since `op1` and `op2` return multiple values, their result tuples are unpacked into separate values, whereas the return value of `op3` requires no unpacking.

Parameter Type Mismatches

Although the Python compiler cannot check the types of arguments passed to a function, the Ice run time does perform validation on the arguments to a proxy invocation and reports any type mismatches as a `ValueError` exception.

Null Parameters

Some Slice types naturally have “empty” or “not there” semantics. Specifically, proxies, sequences, dictionaries, and strings all can be null:

- For proxies, a value of `None` denotes the null proxy. The null proxy is a dedicated value that indicates that a proxy points “nowhere” (denotes no object).
- Sequences and dictionaries cannot be null, but can be empty. To make life with these types easier, whenever you pass `None` as a parameter or return value of type sequence or dictionary, the Ice run time automatically sends an empty sequence or dictionary to the receiver.
- Slice strings cannot be null, but can be empty. Whenever you pass `None` as a parameter or return value, the Ice run time automatically sends an empty string to the receiver.

This behavior is useful as a convenience feature: especially for deeply-nested data types, members that are sequences, dictionaries, or strings automatically arrive as an empty value at the receiving end. This saves you having to explicitly initialize, for example, every string element in a large sequence before sending it in order to avoid a run-time error. Note that using null parameters in this way does *not* create null semantics for sequences, dictionaries, or strings. As far as the object model is concerned, these do not exist (only *empty* sequences, dictionaries, and strings do). For example, it makes no difference to the receiver whether you send a string as `None` or as an empty string: either way, the receiver sees an empty string.

22.13 Exception Handling

Any operation invocation may throw a run-time exception (see Section 22.10) and, if the operation has an exception specification, may also throw user exceptions (see Section 22.9). Suppose we have the following simple interface:

```
exception Tantrum {
    string reason;
};

interface Child {
    void askToCleanUp() throws Tantrum;
};
```

Slice exceptions are thrown as Python exceptions, so you can simply enclose one or more operation invocations in a `try-except` block:

```
child = ...          # Get child proxy...

try:
    child.askToCleanUp()
except Tantrum, t:
    print "The child says:", t.reason
```

Typically, you will catch only a few exceptions of specific interest around an operation invocation; other exceptions, such as unexpected run-time errors, will usually be handled by exception handlers higher in the hierarchy. For example:

```
import traceback, Ice

def run():
    child = ...          # Get child proxy...
    try:
```

```
        child.askToCleanUp()
    except Tantrum, t:
        print "The child says:", t.reason
        child.scold() # Recover from error...
        child.praise() # Give positive feedback...

try:
    # ...
    run()
    # ...
except Ice.Exception:
    traceback.print_exc()
```

This code handles a specific exception of local interest at the point of call and deals with other exceptions generically. (This is also the strategy we used for our first simple application in Chapter 3.)

22.14 Mapping for Classes

Slice classes are mapped to Python classes with the same name. The generated class contains an attribute for each Slice data member (just as for structures and exceptions). Consider the following class definition:

```
class TimeOfDay {
    short hour;           // 0 - 23
    short minute;        // 0 - 59
    short second;        // 0 -59
    string format();     // Return time as hh:mm:ss
};
```

The Python mapping generates the following code for this definition:

```
class TimeOfDay(Ice.Object):
    def __init__(self, hour=0, minute=0, second=0):
        # ...
        self.hour = hour
        self.minute = minute
        self.second = second

    # ...
```

```
#
# Operation signatures.
#
# def format(self, current=None):
```

There are a number of things to note about the generated code:

1. The generated class `TimeOfDay` inherits from `Ice.Object`. This means that all classes implicitly inherit from `Ice.Object`, which is the ultimate ancestor of all classes. Note that `Ice.Object` is *not* the same as `Ice.ObjectPrx`. In other words, you *cannot* pass a class where a proxy is expected and vice versa.
2. The constructor defines an attribute for each Slice data member.
3. A comment summarizes the method signatures for each Slice operation.

There is quite a bit to discuss here, so we will look at each item in turn.

22.14.1 Inheritance from `Ice.Object`

Like interfaces, classes implicitly inherit from a common base class, `Ice.Object`. However, as shown in Figure 22.2, classes inherit from `Ice.Object` instead of `Ice.ObjectPrx` (which is at the base of the inheritance hierarchy for proxies). As a result, you cannot pass a class where a proxy is expected (and vice versa) because the base types for classes and proxies are not compatible.

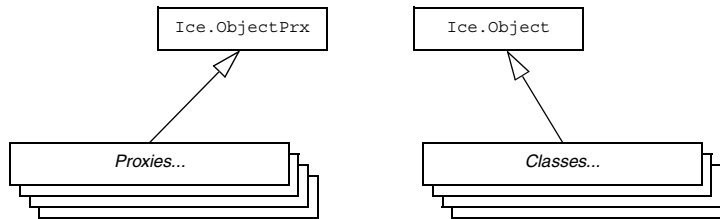

Figure 22.2. Inheritance from `Ice.ObjectPrx` and `Ice.Object`.

`Ice.Object` contains a number of member functions:

```
class Object(object):
    def ice_isA(self, id, current=None):
        # ...

    def ice_ping(self, current=None):
```

```
# ...

def ice_ids(self, current=None):
    # ...

def ice_id(self, current=None):
    # ...

def ice_preMarshal(self):
    # ...

def ice_postUnmarshal(self):
    # ...
```

The member functions of `Ice.Object` behave as follows:

- `ice_isA`
This method returns `true` if the object supports the given type ID, and `false` otherwise.
- `ice_ping`
As for interfaces, `ice_ping` provides a basic reachability test for the class.
- `ice_ids`
This method returns a string sequence representing all of the type IDs supported by this object, including `::Ice::Object`.
- `ice_id`
This method returns the actual run-time type ID for a class. If you call `ice_id` through a reference to a base instance, the returned type id is the actual (possibly more derived) type ID of the instance.
- `ice_preMarshal`
The Ice run time invokes this method prior to marshaling the object's state, providing the opportunity for a subclass to validate its declared data members.
- `ice_postUnmarshal`
The Ice run time invokes this method after unmarshaling an object's state. A subclass typically overrides this function when it needs to perform additional initialization using the values of its declared data members.

22.14.2 Data Members of Classes

Data members of classes are mapped exactly as for structures and exceptions: for each data member in the Slice definition, the generated class contains a corresponding attribute.

22.14.3 Operations of Classes

Operations of classes are mapped to methods in the generated class. This means that, if a class contains operations (such as the `format` operation of our `TimeOfDay` class), you must provide an implementation of the operation in a class that is derived from the generated class. For example:

```
class TimeOfDayI(TimeOfDay):
    def __init__(self, hour=0, minute=0, second=0):
        TimeOfDay.__init__(self, hour, minute, second)

    def format(self, current=None):
        return "%02d:%02d:%02d" %\
            (self.hour, self.minute, self.second)
```

A Slice class such as `TimeOfDay` that declares or inherits an operation is inherently abstract. Python does not support the notion of abstract classes or abstract methods, therefore the mapping merely summarizes the required method signatures in a comment for your convenience. Furthermore, the mapping generates code in the constructor of an abstract class to prevent it from being instantiated directly; any attempt to do so raises a `RuntimeError` exception.

You may notice that the mapping for an operation adds an optional trailing parameter named `current`. For now, you can ignore this parameter and pretend it does not exist. (We look at it in more detail in Section 31.6.)

22.14.4 Class Factories

Having created a class such as this, we have an implementation and we can instantiate the `TimeOfDayI` class, but we cannot receive it as the return value or as an out-parameter from an operation invocation. To see why, consider the following simple interface:

```
interface Time {
    TimeOfDay get();
};
```

When a client invokes the `get` operation, the Ice run time must instantiate and return an instance of the `TimeOfDay` class. However, `TimeOfDay` is an abstract class that cannot be instantiated. Unless we tell it, the Ice run time cannot magically know that we have created a `TimeOfDayI` class that implements the abstract `format` operation of the `TimeOfDay` abstract class. In other words, we must provide the Ice run time with a factory that knows that the `TimeOfDay` abstract class has a `TimeOfDayI` concrete implementation. The `Ice::Communicator` interface provides us with the necessary operations:

```
module Ice {
    local interface ObjectFactory {
        Object create(string type);
        void destroy();
    };

    local interface Communicator {
        void addObjectFactory(ObjectFactory factory, string id);
        ObjectFactory findObjectFactory(string id);
        // ...
    };
};
```

To supply the Ice run time with a factory for our `TimeOfDayI` class, we must implement the `ObjectFactory` interface:

```
class ObjectFactory(Ice.ObjectFactory) :
    def create(self, type):
        if type == "::M::TimeOfDay":
            return TimeOfDayI()
        assert(False)
        return None

    def destroy(self):
        # Nothing to do
        pass
```

The object factory's `create` method is called by the Ice run time when it needs to instantiate a `TimeOfDay` class. The factory's `destroy` method is called by the Ice run time when its communicator is destroyed.

The `create` method is passed the type ID (see Section 4.13) of the class to instantiate. For our `TimeOfDay` class, the type ID is `"::M::TimeOfDay"`. Our implementation of `create` checks the type ID: if it is `"::M::TimeOfDay"`, it instantiates and returns a `TimeOfDayI` object. For other type IDs, it asserts because it does not know how to instantiate other types of objects.

Given a factory implementation, such as our `ObjectFactory`, we must inform the Ice run time of the existence of the factory:

```
ic = ... # Get Communicator...
ic.addObjectFactory(ObjectFactory(), "::M::TimeOfDay")
```

Now, whenever the Ice run time needs to instantiate a class with the type ID `::M::TimeOfDay`, it calls the `create` method of the registered `ObjectFactory` instance.

The `destroy` operation of the object factory is invoked by the Ice run time when the communicator is destroyed. This gives you a chance to clean up any resources that may be used by your factory. Do not call `destroy` on the factory while it is registered with the communicator—if you do, the Ice run time has no idea that this has happened and, depending on what your `destroy` implementation is doing, may cause undefined behavior when the Ice run time tries to next use the factory.

The run time guarantees that `destroy` will be the last call made on the factory, that is, `create` will not be called concurrently with `destroy`, and `create` will not be called once `destroy` has been called. However, calls to `create` can be made concurrently.

Note that you cannot register a factory for the same type ID twice: if you call `addObjectFactory` with a type ID for which a factory is registered, the Ice run time throws an `AlreadyRegisteredException`.

Finally, keep in mind that if a class has only data members, but no operations, you need not create and register an object factory to transmit instances of such a class. Only if a class has operations do you have to define and register an object factory.

22.15 Code Generation

The Python mapping supports two forms of code generation: dynamic and static.

22.15.1 Dynamic Code Generation

Using dynamic code generation, Slice files are “loaded” at run time and dynamically translated into Python code, which is immediately compiled and available for use by the application. This is accomplished using the `Ice.loadSlice` function, as shown in the following example:

```
Ice.loadSlice("Color.ice")
import M

print "My favorite color is", M.Color.blue
```

For this example, we assume that `Color.ice` contains the following definitions:

```
module M {
    enum Color { red, green, blue };
};
```

The code imports module `M` after the `Slice` file is loaded because module `M` is not defined until the `Slice` definitions have been translated into Python.

Ice.loadSlice Options

The `Ice.loadSlice` function behaves like a `Slice` compiler in that it accepts command-line arguments for specifying preprocessor options and controlling code generation. The arguments must include at least one `Slice` file.

The function has the following Python definition:

```
def Ice.loadSlice(cmd, args=[])
```

The command-line arguments can be specified entirely in the first argument, `cmd`, which must be a string. The optional second argument can be used to pass additional command-line arguments as a list; this is useful when the caller already has the arguments in list form. The function always returns `None`.

For example, the following calls to `Ice.loadSlice` are functionally equivalent:

```
Ice.loadSlice("-I/opt/IcePy/slice Color.ice")
Ice.loadSlice("-I/opt/IcePy/slice", ["Color.ice"])
Ice.loadSlice("", ["-I/opt/IcePy/slice", "Color.ice"])
```

In addition to the standard compiler options described in Section 4.19, `Ice.loadSlice` also supports the following command-line options:

- **--all**
Generate code for all `Slice` definitions, including those from included files.
- **--checksum**
Generate checksums for `Slice` definitions. See Section 22.16 for more information.

Loading Multiple Files

You can specify as many Slice files as necessary in a single invocation of `Ice.loadSlice`, as shown below:

```
Ice.loadSlice("Syscall.ice Process.ice")
```

Alternatively, you can call `Ice.loadSlice` several times:

```
Ice.loadSlice("Syscall.ice")
Ice.loadSlice("Process.ice")
```

If a Slice file includes another file, the default behavior of `Ice.loadSlice` generates Python code only for the named file. For example, suppose `Syscall.ice` includes `Process.ice` as follows:

```
// Syscall.ice
#include <Process.ice>
...
```

If you call `Ice.loadSlice("-I. Syscall.ice")`, Python code is not generated for the Slice definitions in `Process.ice` or for any definitions that may be included by `Process.ice`. If you also need code to be generated for included files, one solution is to load them individually in subsequent calls to `Ice.loadSlice`. However, it is much simpler, not to mention more efficient, to use the `--all` option instead:

```
Ice.loadSlice("--all -I. Syscall.ice")
```

When you specify `--all`, `Ice.loadSlice` generates Python code for all Slice definitions included directly or indirectly from the named Slice files.

There is no harm in loading a Slice file multiple times, aside from the additional overhead associated with code generation. For example, this situation could arise when you need to load multiple top-level Slice files that happen to include a common subset of nested files. Suppose that we need to load both `Syscall.ice` and `Kernel.ice`, both of which include `Process.ice`. The simplest way to load both files is with a single call to `Ice.loadSlice`:

```
Ice.loadSlice("--all -I. Syscall.ice Kernel.ice")
```

Although this invocation causes the Ice extension to generate code twice for `Process.ice`, the generated code is structured so that the interpreter ignores duplicate definitions. We could have avoided generating unnecessary code with the following sequence of steps:

```
Ice.loadSlice("--all -I. Syscall.ice")
Ice.loadSlice("-I. Kernel.ice")
```

In more complex cases, however, it can be difficult or impossible to completely avoid this situation, and the overhead of code generation is usually not significant enough to justify such an effort.

22.15.2 Static Code Generation

You should be familiar with static code generation if you have used other Slice language mappings, such as C++ or Java. Using static code generation, the Slice compiler **slice2py** (see Section 22.15.4) generates Python code from your Slice definitions.

Compiler Output

For each Slice file `X.ice`, **slice2py** generates Python code into a file named `X_ice.py`² in the output directory. The default output directory is the current working directory, but a different directory can be specified using the `--output-dir` option.

In addition to the generated file, **slice2py** creates a Python package for each Slice module it encounters. A Python package is nothing more than a subdirectory that contains a file with a special name (`__init__.py`). This file is executed automatically by Python when a program first imports the package. It is created by **slice2py** and must not be edited manually. Inside the file is Python code to import the generated files that contain definitions in the Slice module of interest.

For example, the Slice files `Process.ice` and `Syscall.ice` both define types in the Slice module `OS`. First we present `Process.ice`:

```
module OS {
    interface Process {
        void kill();
    };
};
```

And here is `Syscall.ice`:

2. Using the filename `X.py` would create problems if `X.ice` defined a module named `X`, therefore the suffix `_ice` is appended to the name of the generated file.

```
#include <Process.ice>
module OS {
    interface Syscall {
        Process getProcess(int pid);
    };
};
```

Next, we translate these files using the Slice compiler:

```
> slice2py -I. Process.ice Syscall.ice
```

If we list the contents of the output directory, we see the following entries:

```
OS/
Process_ice.py
Syscall_ice.py
```

The subdirectory OS is the Python package that **slice2py** created for the Slice module OS. Inside this directory is the special file `__init__.py` that contains the following statements:

```
import Process_ice
import Syscall_ice
```

Now when a Python program executes `import OS`, the two files `Process_ice.py` and `Syscall_ice.py` are implicitly imported.

Subsequent invocations of **slice2py** for Slice files that also contain definitions in the OS module result in additional `import` statements being added to `OS/__init__.py`. Be aware, however, that `import` statements may persist in `__init__.py` files after a Slice file is renamed or becomes obsolete. This situation may manifest itself as a run-time error if the interpreter can no longer locate the generated file while attempting to import the package. It may also cause more subtle problems, if an obsolete generated file is still present and being loaded unintentionally. In general, it is advisable to remove the package directory and regenerate it whenever the set of Slice files changes.

A Python program may also import a generated file explicitly, using a statement such as `import Process_ice`. Typically, however, it is more convenient to import the Python module once, rather than importing potentially several individual files that comprise the module, especially when you consider that the program must still import the module explicitly in order to make its definitions available. For example, it is much simpler to state

```
import OS
```

rather than the following alternative:

```
import Process_ice
import Syscall_ice
import OS
```

In situations where a Python package is unnecessary or undesirable, the **--no-package** option can be specified to prevent the creation of a package. In this case, the application must import the generated file(s) explicitly, as shown above.

Include Files

It is important to understand how **slice2py** handles include files. In the absence of the **--all** option, the compiler does not generate Python code for Slice definitions in included files. Rather, the compiler translates Slice `#include` statements into Python `import` statements in the following manner:

1. Determine the full pathname of the include file.
2. Create the shortest possible relative pathname for the include file by iterating over each of the include directories (specified using the `-I` option) and removing the leading directory from the include file if possible.

For example, if the full pathname of an include file is `/opt/App/slice/OS/Process.ice`, and we specified the options `-I/opt/App` and `-I/opt/App/slice`, then the shortest relative pathname is `OS/Process.ice` after removing `/opt/App/slice`.

3. Replace any slashes with underscores, remove the `.ice` extension, and append `_ice`. Continuing our example from the previous step, the translated `import` statement becomes

```
import OS_Process_ice
```

There is a potential problem here that must be addressed. The generated `import` statement shown above expects to find the file `OS_Process_ice.py` somewhere in Python's search path. However, **slice2py** uses a different default name, `Process_ice.py`, when it compiles `Process.ice`. To resolve this issue, we must use the **--prefix** option when compiling `Process.ice`:

```
> slice2py --prefix OS_ Process.ice
```

The **--prefix** option causes the compiler to prepend the specified prefix to the name of each generated file. When executed, the above command creates the desired filename: `OS_Process_ice.py`.

It should be apparent by now that generating Python code for a complex Ice application requires a bit of planning. In particular, it is imperative that you be

consistent in your use of `#include` statements, include directories, and `--prefix` options to ensure that the correct filenames are used at all times.

Of course, these precautionary steps are only necessary when you are compiling Slice files individually. An alternative is to use the `--all` option and generate Python code for all of your Slice definitions into one Python source file. If you do not have a suitable Slice file that includes all necessary Slice definitions, you could write a “master” Slice file specifically for this purpose.

22.15.3 Static Versus Dynamic Code Generation

There are several issues to consider when evaluating your requirements for code generation.

Application Considerations

The requirements of your application generally dictate whether you should use dynamic or static code generation. Dynamic code generation is convenient for a number of reasons:

- it avoids the intermediate compilation step required by static code generation
- it makes the application more compact because the application requires only the Slice files, not the assortment of files and directories produced by static code generation
- it reduces complexity, which is especially helpful during testing, or when writing short or transient programs.

Static code generation, on the other hand, is appropriate in many situations:

- when an application uses a large number of Slice definitions and the startup delay must be minimized
- when it is not feasible to deploy Slice files with the application
- when a number of applications share the same Slice files
- when Python code is required in order to utilize third-party Python tools.

Mixing Static and Dynamic Generation

Using a combination of static and dynamic translation in an application can produce unexpected results. For example, consider a situation where a dynamically-translated Slice file includes another Slice file that was statically translated:

```
// Slice
#include <Glacier2/Session.ice>

module App {
    interface SessionFactory {
        Glacier2::Session* createSession();
    };
};
```

The Slice file `Session.ice` is statically translated, as are all of the Slice files included with the Ice run time.

Assuming the above definitions are saved in `App.ice`, let's execute a simple Python script:

```
# Python
import Ice
Ice.loadSlice("-I/opt/Ice/slice App.ice")

import Glacier2
class MyVerifier(Glacier2.PermissionsVerifier): # Error
    def checkPermissions(self, userId, password):
        return (True, "")
```

The code looks reasonable, but running it produces the following error:

```
'module' object has no attribute 'PermissionsVerifier'
```

Normally, importing the `Glacier2` module as we have done here would load all of the Python code generated for the `Glacier2` Slice files. However, since `App.ice` has already included a subset of the `Glacier2` definitions, the Python interpreter ignores any subsequent requests to import the entire module, and therefore the `PermissionsVerifier` type is not present.

One way to address this problem is to import the statically-translated modules first, prior to loading Slice files dynamically:

```
# Python
import Ice, Glacier2 # Import Glacier2 before App.ice is loaded
Ice.loadSlice("-I/opt/Ice/slice App.ice")

class MyVerifier(Glacier2.PermissionsVerifier): # OK
    def checkPermissions(self, userId, password):
        return (True, "")
```

The disadvantage of this approach in a non-trivial application is that it breaks encapsulation, forcing one Python module to know what other modules are doing.

For example, suppose we place our `PermissionsVerifier` implementation in a module named `verifier.py`:

```
# Python
import Glacier2
class MyVerifier(Glacier2.PermissionsVerifier):
    def checkPermissions(self, userId, password):
        return (True, "")
```

Now that the use of `Glacier2` definitions is encapsulated in `verifier.py`, we would like to remove references to `Glacier2` from the main script:

```
# Python
import Ice
Ice.loadSlice("-I/opt/Ice/slice App.ice")
...
import verifier # Error
v = verifier.MyVerifier()
```

Unfortunately, executing this script produces the same error as before. To fix it, we have to break the `verifier` module's encapsulation and import the `Glacier2` module in the main script because we know that the `verifier` module requires it:

```
# Python
import Ice, Glacier2
Ice.loadSlice("-I/opt/Ice/slice App.ice")
...
import verifier # OK
v = verifier.MyVerifier()
```

Although breaking encapsulation in this way might offend our sense of good design, it is a relatively minor issue.

Another solution is to import the necessary submodules explicitly. We can safely remove the `Glacier2` reference from our main script after rewriting `verifier.py` as shown below:

```
# Python
import Glacier2_PermissionsVerifier_ice
import Glacier2
class MyVerifier(Glacier2.PermissionsVerifier):
    def checkPermissions(self, userId, password):
        return (True, "")
```

Using the rules defined in Section 22.15.2, we can derive the name of the module containing the code generated for `PermissionsVerifier.ice` and import it

directly. We need a second `import` statement to make the Glacier2 definitions accessible in this module.

22.15.4 `slice2py` Command-Line Options

The Slice-to-Python compiler, `slice2py`, offers the following command-line options in addition to the standard options described in Section 4.19:

- `--all`
Generate code for all Slice definitions, including those from included files.
- `--no-package`
Do not generate Python packages for the Slice definitions. See Section 22.15.2 for more information.
- `--checksum`
Generate checksums for Slice definitions.
- `--prefix PREFIX`
Use `PREFIX` as the prefix for generated filenames. See Section 22.15.2 for more information.

22.15.5 Packages

By default, the scope of a Slice definition determines the module of its mapped Python construct (see Section 22.4 for more information on the module mapping). There are times, however, when applications require greater control over the packaging of generated Python code. For example, consider the following Slice definitions:

```
module sys {
    interface Process {
        // ...
    };
};
```

Other language mappings can use these Slice definitions as shown, but they present a problem for the Python mapping: the top-level Slice module `sys` conflicts with Python's predefined module `sys`. A Python application executing the statement `import sys` would import whichever module the interpreter happens to locate first in its search path.

A workaround for this problem is to modify the Slice definitions so that the top-level module no longer conflicts with a predefined Python module, but that may not be feasible in certain situations. For example, the application may already be deployed using other language mappings, in which case the impact of modifying the Slice definitions could represent an unacceptable expense.

The Python mapping could have addressed this issue by considering the names of predefined modules to be reserved, in which case the Slice module `sys` would be mapped to the Python module `_sys`. However, the likelihood of a name conflict is relatively low to justify such a solution, therefore the mapping supports a different approach: global metadata (see Section 4.17) can be used to enclose generated code in a Python package. Our modified Slice definitions demonstrate this feature:

```
[["python:package:zeroc"]]
module sys {
    interface Process {
        // ...
    };
};
```

The global metadata directive `python:package:zeroc` causes the mapping to generate all of the code resulting from definitions in this Slice file into the Python package `zeroc`. The net effect is the same as if we had enclosed our Slice definitions in the module `zeroc`: the Slice module `sys` is mapped to the Python module `zeroc.sys`. However, by using metadata we have not affected the semantics of the Slice definitions, nor have we affected other language mappings.

22.16 Using Slice Checksums

As described in Section 4.20, the Slice compilers can optionally generate checksums of Slice definitions. For `slice2py`, the `--checksum` option causes the compiler to generate code that adds checksums to the dictionary `Ice.sliceChecksums`. The checksums are installed automatically when the Python code is first imported; no action is required by the application.

In order to verify a server's checksums, a client could simply compare the dictionaries using the comparison operator. However, this is not feasible if it is possible that the server might return a superset of the client's checksums. A more general solution is to iterate over the local checksums as demonstrated below:

```
serverChecksums = ...
for i in Ice.sliceChecksums:
    if not serverChecksums.has_key(i):
        # No match found for type id!
    elif Ice.sliceChecksums[i] != serverChecksums[i]:
        # Checksum mismatch!
```

In this example, the client first verifies that the server's dictionary contains an entry for each Slice type ID, and then it proceeds to compare the checksums.

Chapter 23

Developing a File System Client in Python

23.1 Chapter Overview

In this chapter, we present the source code for a Python client that accesses the file system we developed in Chapter 5 (see Chapter 25 for the corresponding server).

23.2 The Python Client

We now have seen enough of the client-side Python mapping to develop a complete client to access our remote file system. For reference, here is the Slice definition once more:

```
module Filesystem {
    interface Node {
        nonmutating string name();
    };

    exception GenericError {
        string reason;
    };

    sequence<string> Lines;

    interface File extends Node {
```

```

        nonmutating Lines read();
        idempotent void write(Lines text) throws GenericError;
};

sequence<Node*> NodeSeq;

interface Directory extends Node {
    nonmutating NodeSeq list();
};

interface Filesys {
    nonmutating Directory* getRoot();
};
};

```

To exercise the file system, the client does a recursive listing of the file system, starting at the root directory. For each node in the file system, the client shows the name of the node and whether that node is a file or directory. If the node is a file, the client retrieves the contents of the file and prints them.

The body of the client code looks as follows:

```

import sys, traceback, Ice, Filesystem

# Recursively print the contents of directory "dir"
# in tree fashion. For files, show the contents of
# each file. The "depth" parameter is the current
# nesting level (for indentation).

def listRecursive(dir, depth):
    indent = ''
    depth = depth + 1
    for i in range(depth):
        indent = indent + '\t'

    contents = dir.list()

    for node in contents:
        subdir = Filesystem.DirectoryPrx.checkedCast(node)
        file = Filesystem.FilePrx.uncheckedCast(node)
        print indent + node.name(),
        if subdir:
            print "(directory):"
            listRecursive(subdir, depth)
        else:
            print "(file):"

```

```
        text = file.read()
        for line in text:
            print indent + "\t" + line

status = 0
ic = None
try:
    # Create a communicator
    #
    ic = Ice.initialize(sys.argv)

    # Create a proxy for the root directory
    #
    obj = ic.stringToProxy("RootDir:default -p 10000")

    # Down-cast the proxy to a Directory proxy
    #
    rootDir = Filesystem.DirectoryPrx.checkedCast(obj)

    # Recursively list the contents of the root directory
    #
    print "Contents of root directory:"
    listRecursive(rootDir, 0)
except:
    traceback.print_exc()
    status = 1

if ic:
    # Clean up
    #
    try:
        ic.destroy()
    except:
        traceback.print_exc()
        status = 1

sys.exit(status)
```

The program first defines the `listRecursive` function, which is a helper function to print the contents of the file system, and the main program follows. Let us look at the main program first:

1. The structure of the code follows what we saw in XREF. After initializing the run time, the client creates a proxy to the root directory of the file system. For this example, we assume that the server runs on the local host and listens using

the default protocol (TCP/IP) at port 10000. The object identity of the root directory is known to be `RootDir`.

2. The client down-casts the proxy to `DirectoryPrx` and passes that proxy to `listRecursive`, which prints the contents of the file system.

Most of the work happens in `listRecursive`. The function is passed a proxy to a directory to list, and an indent level. (The indent level increments with each recursive call and allows the code to print the name of each node at an indent level that corresponds to the depth of the tree at that node.) `listRecursive` calls the `list` operation on the directory and iterates over the returned sequence of nodes:

1. The code does a `checkedCast` to narrow the `Node` proxy to a `Directory` proxy, as well as an `uncheckedCast` to narrow the `Node` proxy to a `File` proxy. Exactly one of those casts will succeed, so there is no need to call `checkedCast` twice: if the `Node` *is-a* `Directory`, the code uses the `DirectoryPrx` returned by the `checkedCast`; if the `checkedCast` fails, we *know* that the `Node` *is-a* `File` and, therefore, an `uncheckedCast` is sufficient to get a `FilePrx`.

In general, if you know that a down-cast to a specific type will succeed, it is preferable to use an `uncheckedCast` instead of a `checkedCast` because an `uncheckedCast` does not incur any network traffic.

2. The code prints the name of the file or directory and then, depending on which cast succeeded, prints "`(directory)`" or "`(file)`" following the name.
3. The code checks the type of the node:
 - If it is a directory, the code recurses, incrementing the indent level.
 - If it is a file, the code calls the `read` operation on the file to retrieve the file contents and then iterates over the returned sequence of lines, printing each line.

Assume that we have a small file system consisting of a two files and a a directory as follows:

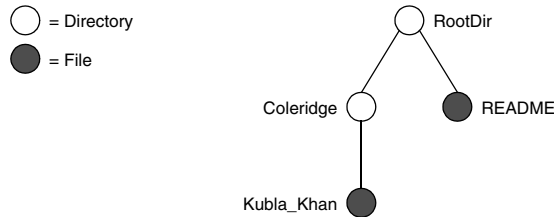

Figure 23.1. A small file system.

The output produced by client for this file system is:

```

Contents of root directory:
  README (file):
    This file system contains a collection of poetry.
  Coleridge (directory):
    Kubla_Khan (file):
      In Xanadu did Kubla Khan
      A stately pleasure-dome decree:
      Where Alph, the sacred river, ran
      Through caverns measureless to man
      Down to a sunless sea.
  
```

Note that, so far, our client (and server) are not very sophisticated:

- The protocol and address information are hard-wired into the code.
- The client makes more remote procedure calls than strictly necessary; with minor redesign of the Slice definitions, many of these calls can be avoided.

We will see how to address these shortcomings in Chapter 37 and XREF.

23.3 Summary

This chapter presented a very simple client to access a server that implements the file system we developed in Chapter 5. As you can see, the Python code hardly differs from the code you would write for an ordinary Python program. This is one of the biggest advantages of using Ice: accessing a remote object is as easy as accessing an ordinary, local Python object. This allows you to put your effort where you should, namely, into developing your application logic instead of

having to struggle with arcane networking APIs. As we will see in Chapter 25, this is true for the server side as well, meaning that you can develop distributed applications easily and efficiently.

Chapter 24

Server-Side Slice-to-Python Mapping

24.1 Chapter Overview

In this chapter, we present the server-side Slice-to-Python mapping (see Chapter 22 for the client-side mapping). Section 24.3 discusses how to initialize and finalize the server-side run time, sections 24.4 to 24.6 show how to implement interfaces and operations, and Section 24.7 discusses how to register objects with the server-side Ice run time.

24.2 Introduction

The mapping for Slice data types to Python is identical on the client side and server side. This means that everything in Chapter 22 also applies to the server side. However, for the server side, there are a few additional things you need to know, specifically:

- how to initialize and finalize the server-side run time
- how to implement servants
- how to pass parameters and throw exceptions
- how to create servants and register them with the Ice run time.

We discuss these topics in the remainder of this chapter.

24.3 The Server-Side `main` Program

The main entry point to the Ice run time is represented by the local interface `Ice::Communicator`. As for the client side, you must initialize the Ice run time by calling `Ice.initialize` before you can do anything else in your server. `Ice.initialize` returns a reference to an instance of an `Ice.Communicator`:

```
import sys, traceback, Ice

status = 0
ic = None
try:
    ic = Ice.initialize(sys.argv)
    # ...
except:
    traceback.print_exc()
    status = 1

# ...
```

`Ice.initialize` accepts the argument list that is passed to the program by the operating system. The function scans the argument list for any command-line options that are relevant to the Ice run time; any such options are removed from the argument list so, when `Ice.initialize` returns, the only options and arguments remaining are those that concern your application. If anything goes wrong during initialization, `initialize` throws an exception.

Before leaving your program, you *must* call `Communicator::destroy`. The `destroy` operation is responsible for finalizing the Ice run time. In particular, `destroy` waits for any operation invocations that may still be running to complete. In addition, `destroy` ensures that any outstanding threads are joined with and reclaims a number of operating system resources, such as file descriptors and memory. Never allow your program to terminate without calling `destroy` first; doing so has undefined behavior.

The general shape of our server-side program is therefore as follows:

```
import sys, traceback, Ice

status = 0
ic = None
try:
    ic = Ice.initialize(sys.argv)
    # ...
except:
```

```
        traceback.print_exc()
        status = 1

if ic:
    try:
        ic.destroy()
    except:
        traceback.print_exc()
        status = 1

sys.exit(status)
```

Note that the code places the call to `Ice.initialize` into a `try` block and takes care to return the correct exit status to the operating system. Also note that an attempt to destroy the communicator is made only if the initialization succeeded.

24.3.1 The `Ice.Application` Class

The preceding program structure is so common that `Ice` offers a class, `Ice.Application`, that encapsulates all the correct initialization and finalization activities. The synopsis of the class is as follows (with some detail omitted for now):

```
class Application(object):

    def __init__(self):

    def main(self, args, configFile=None):

    def run(self, args):

    def appName():
        # ...
    appName = staticmethod(appName)

    def communicator():
        # ...
    communicator = staticmethod(communicator)
```

The intent of this class is that you specialize `Ice.Application` and implement the abstract `run` method in your derived class. Whatever code you would normally place in your main program goes into `run` instead. Using `Ice.Application`, our program looks as follows:

```
import sys, Ice

class Server(Ice.Application):
    def run(self, args):
        # Server code here...
        return 0

app = Server()
status = app.main(sys.argv)
sys.exit(status)
```

The `Application.main` function does the following:

1. It installs an exception handler. If your code fails to handle an exception, `Application.main` prints the exception information before returning with a non-zero return value.
2. It initializes (by calling `Ice.initialize`) and finalizes (by calling `Communicator.destroy`) a communicator. You can get access to the communicator for your server by calling the static `communicator` accessor.
3. It scans the argument list for options that are relevant to the Ice run time and removes any such options. The argument list that is passed to your `run` method therefore is free of Ice-related options and only contains options and arguments that are specific to your application.
4. It provides the name of your application via the static `appName` member function. The return value from this call is the first element of the argument vector passed to `Application.main`, so you can get at this name from anywhere in your code by calling `Ice.Application.appName` (which is usually required for error messages).
5. It installs a signal handler that properly shuts down the communicator.

Using `Ice.Application` ensures that your program properly finalizes the Ice run time, whether your server terminates normally or in response to an exception or signal. We recommend that all your programs use this class; doing so makes your life easier. In addition `Ice.Application` also provides features for signal handling and configuration that you do not have to implement yourself when you use this class.

Using `Ice.Application` on the Client Side

You can use `Ice.Application` for your clients as well: simply implement a class that derives from `Ice.Application` and place the client code into its `run` method. The advantage of this approach is the same as for the server side:

`Ice.Application` ensures that the communicator is destroyed correctly even in the presence of exceptions or signals.

Catching Signals

The simple server we developed in Chapter 3 had no way to shut down cleanly: we simply interrupted the server from the command line to force it to exit. Terminating a server in this fashion is unacceptable for many real-life server applications: typically, the server has to perform some cleanup work before terminating, such as flushing database buffers or closing network connections. This is particularly important on receipt of a signal or keyboard interrupt to prevent possible corruption of database files or other persistent data.

To make it easier to deal with signals, `Ice.Application` encapsulates Python's signal handling capabilities, allowing you to cleanly shut down on receipt of a signal:

```
class Application(object):
    # ...
    def destroyOnInterrupt():
        # ...
    destroyOnInterrupt = staticmethod(destroyOnInterrupt)

    def shutdownOnInterrupt():
        # ...
    shutdownOnInterrupt = staticmethod(shutdownOnInterrupt)

    def ignoreInterrupt():
        # ...
    ignoreInterrupt = staticmethod(ignoreInterrupt)

    def holdInterrupt():
        # ...
    holdInterrupt = staticmethod(holdInterrupt)

    def releaseInterrupt():
        # ...
    releaseInterrupt = staticmethod(releaseInterrupt)

    def interrupted():
        # ...
    interrupted = staticmethod(interrupted)
```

These static methods behave as follows:

- `destroyOnInterrupt`
This method installs a signal handler that destroys the communicator if it is interrupted. This is the default behavior.
- `shutdownOnInterrupt`
This method installs a signal handler that shuts down the communicator if it is interrupted.
- `ignoreInterrupt`
This method causes signals to be ignored.
- `holdInterrupt`
This method temporarily blocks signal delivery.
- `releaseInterrupt`
This method restores signal delivery to the previous disposition. Any signal that arrives after `holdInterrupt` was called is delivered when you call `releaseInterrupt`.
- `interrupted`
This method returns `True` if a signal caused the communicator to shut down, `False` otherwise. This allows us to distinguish intentional shutdown from a forced shutdown that was caused by a signal. This is useful, for example, for logging purposes.

By default, `Ice.Application` behaves as if `destroyOnInterrupt` was invoked, therefore our server program requires no change to ensure that the program terminates cleanly on receipt of a signal. However, we add a diagnostic to report the occurrence of a signal, so our program now looks like:

```
import sys, Ice

class MyApplication(Ice.Application):
    def run(self, args):

        # Server code here...

        if self.interrupted():
            print self.appName() + ": terminating"

        return 0

app = MyApplication()
status = app.main(sys.argv)
sys.exit(status)
```

Note that, if your server is interrupted by a signal, the Ice run time waits for all currently executing operations to finish. This means that an operation that updates persistent state cannot be interrupted in the middle of what it was doing and cause partial update problems.

Ice.Application and Properties

Apart from the functionality shown in this section, `Ice.Application` also takes care of initializing the Ice run time with property values. Properties allow you to configure the run time in various ways. For example, you can use properties to control things such as the thread pool size or port number for a server. The `main` method of `Ice.Application` accepts an optional second parameter allowing you to specify the name of a configuration file that will be processed during initialization. We discuss Ice properties in more detail in Chapter 30.

Limitations of Ice.Application

`Ice.Application` is a singleton class that creates a single communicator. If you are using multiple communicators, you cannot use `Ice.Application`. Instead, you must structure your code as we saw in Chapter 3 (taking care to always destroy the communicator).

24.4 Mapping for Interfaces

The server-side mapping for interfaces provides an up-call API for the Ice run time: by implementing methods in a servant class, you provide the hook that gets the thread of control from the Ice server-side run time into your application code.

24.4.1 Skeleton Classes

On the client side, interfaces map to proxy classes (see Section 5.12). On the server side, interfaces map to *skeleton* classes. A skeleton is an abstract base class from which you derive your servant class and define a method for each operation on the corresponding interface. For example, consider the Slice definition for the `Node` interface we defined in Chapter 5 once more:

```

module Filesystem {
    interface Node {
        nonmutating string name();
    };
    // ...
};

```

The Python mapping generates the following definition for this interface:

```

class Node(Ice.Object):
    def __init__(self):
        # ...

    #
    # Operation signatures.
    #
    # def name(self, current=None):

```

The important points to note here are:

- As for the client side, Slice modules are mapped to Python modules with the same name, so the skeleton class definitions are part of the `Filesystem` module.
- The name of the skeleton class is the same as the name of the Slice interface (`Node`).
- The skeleton class contains a comment summarizing the method signature of each operation in the Slice interface.
- The skeleton class is an abstract base class because its constructor prevents direct instantiation of the class.
- The skeleton class inherits from `Ice.Object` (which forms the root of the Ice object hierarchy).

24.4.2 Servant Classes

In order to provide an implementation for an Ice object, you must create a servant class that inherits from the corresponding skeleton class. For example, to create a servant for the `Node` interface, you could write:

```

import Filesystem

class NodeI(Filesystem.Node):
    def __init__(self, name):

```

```

        self._name = name

    def name(self, current=None):
        return self._name

```

By convention, servant classes have the name of their interface with an I-suffix, so the servant class for the `Node` interface is called `NodeI`. (This is a convention only: as far as the Ice run time is concerned, you can choose any name you prefer for your servant classes.) Note that `NodeI` extends `Filesystem.Node`, that is, it derives from its skeleton class.

As far as Ice is concerned, the `NodeI` class must implement only a single method: the `name` method that is defined in the `Node` interface. This makes the servant class a concrete class that can be instantiated. You can add other member functions and data members as you see fit to support your implementation. For example, in the preceding definition, we added a `_name` member and a constructor. (Obviously, the constructor initializes the `_name` member and the `name` function returns its value.)

Normal, idempotent, and nonmutating Operations

Whether an operation is an ordinary operation, or an `idempotent` or `nonmutating` operation has no influence on the way the operation is mapped. To illustrate this, consider the following interface:

```

interface Example {
    void normalOp();
    idempotent void idempotentOp();
    nonmutating void nonmutatingOp();
};

```

The mapping for this interface is shown below:

```

class Example(Ice.Object):
    # ...

    #
    # Operation signatures.
    #
    # def normalOp(self, current=None):
    # def idempotentOp(self, current=None):
    # def nonmutatingOp(self, current=None):

```

Note that the signatures of the methods are unaffected by the `idempotent` and `nonmutating` qualifiers. (In C++, the `nonmutating` qualifier generates a C++ `const` member function.)

24.5 Parameter Passing

For each `in` parameter of a Slice operation, the Python mapping generates a corresponding parameter for the corresponding method. In addition, every operation has an additional, trailing parameter of type `Ice.Current`. For example, the `name` operation of the `Node` interface has no parameters, but the `name` method in a Python servant has a `current` parameter. We explain the purpose of this parameter in Section 31.6 and will ignore it for now.

An operation returning multiple values¹ returns them in a tuple consisting of a non-void return value, if any, followed by the `out` parameters in the order of declaration. An operation returning only one value simply returns the value itself.

To illustrate these rules, consider the following interface that passes string parameters in all possible directions:

```
interface Example {
    string op1(string sin);
    void op2(string sin, out string sout);
    string op3(string sin, out string sout);
};
```

The generated skeleton class for this interface looks as follows:

```
class Example(Ice.Object):
    def __init__(self):
        # ...

    #
    # Operation signatures.
    #
    # def op1(self, sin, current=None):
    # def op2(self, sin, current=None):
    # def op3(self, sin, current=None):
```

The signatures of the Python methods are identical because they all accept a single `in` parameter, but their implementations differ in the way they return values. For example, we could implement the operations as follows:

1. An operation returns multiple values when it declares multiple `out` parameters, or when it declares a non-void return type and at least one `out` parameter.

```
class ExampleI(Example):
    def op1(self, sin, current=None):
        print sin                # In params are initialized
        return "Done"           # Return value

    def op2(self, sin, current=None):
        print sin                # In params are initialized
        return "Hello World!"   # Out parameter

    def op3(self, sin, current=None):
        print sin                # In params are initialized
        return ("Done", "Hello World!")
```

Notice that `op1` and `op2` return their string values directly, whereas `op3` returns a tuple consisting of the return value followed by the out parameter.

This code is in no way different from what you would normally write if you were to pass strings to and from a function; the fact that remote procedure calls are involved does not impact on your code in any way. The same is true for parameters of other types, such as proxies, classes, or dictionaries: the parameter passing conventions follow normal Python rules and do not require special-purpose API calls.

24.6 Raising Exceptions

To throw an exception from an operation implementation, you simply instantiate the exception, initialize it, and throw it. For example:

```
class FileI(Filesystem.File):
    # ...

    def write(self, text, current=None):
        # Try to write the file contents here...
        # Assume we are out of space...
        if error:
            e = Filesystem.GenericError()
            e.reason = "file too large"
            raise e
```

The mapping for exceptions (see Section 22.9) generates a constructor that accepts values for data members, so we can simplify this example by changing our `raise` statement to the following:

```
class FileI(Filesystem.File):
    # ...

    def write(self, text, current=None):
        # Try to write the file contents here...
        # Assume we are out of space...
        if error:
            raise Filesystem.GenericError("file too large")
```

If you throw an arbitrary Python run-time exception, the Ice run time catches the exception and then returns an `UnknownException` to the client. Similarly, if you throw an “impossible” user exception (a user exception that is not listed in the exception specification of the operation), the client receives an `UnknownUserException`.

If you throw an Ice run-time exception, such `MemoryLimitException`, the client receives an `UnknownLocalException`.² For that reason, you should never throw system exceptions from operation implementations. If you do, all the client will see is an `UnknownLocalException`, which does not tell the client anything useful.

24.7 Object Incarnation

Having created a servant class such as the rudimentary `NodeI` class in Section 24.4.2, you can instantiate the class to create a concrete servant that can receive invocations from a client. However, merely instantiating a servant class is insufficient to incarnate an object. Specifically, to provide an implementation of an Ice object, you must take the following steps:

1. Instantiate a servant class.
2. Create an identity for the Ice object incarnated by the servant.
3. Inform the Ice run time of the existence of the servant.
4. Pass a proxy for the object to a client so the client can reach it.

2. There are three run-time exceptions that are not changed to `UnknownLocalException` when returned to the client: `ObjectNotExistException`, `OperationNotExistException`, and `FacetNotExistException`. We discuss these exceptions in more detail in Chapter 33.

24.7.1 Instantiating a Servant

Instantiating a servant means to allocate an instance:

```
servant = NodeI("Fred")
```

This statement creates a new `NodeI` instance and assigns its reference to the variable `servant`.

24.7.2 Creating an Identity

Each Ice object requires an identity. That identity must be unique for all servants using the same object adapter.³ An Ice object identity is a structure with the following Slice definition:

```
module Ice {
    struct Identity {
        string name;
        string category;
    };
    // ...
};
```

The full identity of an object is the combination of both the name and category fields of the `Identity` structure. For now, we will leave the category field as the empty string and simply use the name field. (See Section 31.6 for a discussion of the category field.)

To create an identity, we simply assign a key that identifies the servant to the name field of the `Identity` structure:

```
id = Ice.Identity()
id.name = "Fred" # Not unique, but good enough for now
```

Note that the mapping for structures (see Section 22.7.2) allows us to write the following equivalent code:

```
id = Ice.Identity("Fred") # Not unique, but good enough for now
```

3. The Ice object model assumes that all objects (regardless of their adapter) have a globally unique identity. See XREF for further discussion.

24.7.3 Activating a Servant

Merely creating a servant instance does nothing: the Ice run time becomes aware of the existence of a servant only once you explicitly tell the object adapter about the servant. To activate a servant, you invoke the `add` operation on the object adapter. Assuming that we have access to the object adapter in the `adapter` variable, we can write:

```
adapter.add(servant, id)
```

Note the two arguments to `add`: the servant and the object identity. Calling `add` on the object adapter adds the servant and the servant's identity to the adapter's servant map and links the proxy for an Ice object to the correct servant instance in the server's memory as follows:

1. The proxy for an Ice object, apart from addressing information, contains the identity of the Ice object. When a client invokes an operation, the object identity is sent with the request to the server.
2. The object adapter receives the request, retrieves the identity, and uses the identity as an index into the servant map.
3. If a servant with that identity is active, the object adapter retrieves the servant from the servant map and dispatches the incoming request into the correct member function on the servant.

Assuming that the object adapter is in the active state (see Section 31.4), client requests are dispatched to the servant as soon as you call `add`.

24.7.4 UUIDs as Identities

As we discussed in Section 2.5.1, the Ice object model assumes that object identities are globally unique. One way of ensuring that uniqueness is to use UUIDs (Universally Unique Identifiers) [14] as identities. The `Ice.generateUUID` function creates such identities:

```
import Ice
print Ice.generateUUID()
```

When executed, this program prints a unique string such as `5029a22c-e333-4f87-86b1-cd5e0fcce509`. Each call to `generateUUID` creates a string that differs from all previous ones.⁴ You can use a UUID such as this to create object identities. For convenience, the object adapter has an operation `addWithUUID` that generates a UUID and adds a servant to the servant

map in a single step. Using this operation, we can create an identity and register a servant with that identity in a single step as follows:

```
adapter.addWithUUID(NodeI("Fred"))
```

24.7.5 Creating Proxies

Once we have activated a servant for an Ice object, the server can process incoming client requests for that object. However, clients can only access the object once they hold a proxy for the object. If a client knows the server's address details and the object identity, it can create a proxy from a string, as we saw in our first example in Chapter 3. However, creation of proxies by the client in this manner is usually only done to allow the client access to initial objects for bootstrapping. Once the client has an initial proxy, it typically obtains further proxies by invoking operations.

The object adapter contains all the details that make up the information in a proxy: the addressing and protocol information, and the object identity. The Ice run time offers a number of ways to create proxies. Once created, you can pass a proxy to the client as the return value or as an out-parameter of an operation invocation.

Proxies and Servant Activation

The `add` and `addWithUUID` servant activation operations on the object adapter return a proxy for the corresponding Ice object. This means we can write:

```
proxy = adapter.addWithUUID(NodeI("Fred"))
nodeProxy = Filesystem.NodePrx.uncheckedCast(proxy)

# Pass nodeProxy to client...
```

Here, `addWithUUID` both activates the servant and returns a proxy for the Ice object incarnated by that servant in a single step.

Note that we need to use an `uncheckedCast` here because `addWithUUID` returns a proxy of type `Ice.ObjectPrx`.

Direct Proxy Creation

The object adapter offers an operation to create a proxy for a given identity:

4. Well, almost: eventually, the UUID algorithm wraps around and produces strings that repeat themselves, but this will not happen until approximately the year 3400.

```
module Ice {
    local interface ObjectAdapter {
        Object* createProxy(Identity id);
        // ...
    };
};
```

Note that `createProxy` creates a proxy for a given identity whether a servant is activated with that identity or not. In other words, proxies have a life cycle that is quite independent from the life cycle of servants:

```
id = Ice.Identity()
id.name = Ice.generateUUID()
proxy = adapter.createProxy(id)
```

This creates a proxy for an Ice object with the identity returned by `generateUUID`. Obviously, no servant yet exists for that object so, if we return the proxy to a client and the client invokes an operation on the proxy, the client will receive an `ObjectNotExistException`. (We examine these life cycle issues in more detail in XREF.)

24.8 Summary

This chapter presented the server-side Python mapping. Because the mapping for Slice data types is identical for clients and servers, the server-side mapping only adds a few additional mechanism to the client side: a small API to initialize and finalize the run time, plus a few rules for how to derive servant classes from skeletons and how to register servants with the server-side run time.

Even though the examples in this chapter are very simple, they accurately reflect the basics of writing an Ice server. Of course, for more sophisticated servers (which we discuss in Chapter 31), you will be using additional APIs, for example, to improve performance or scalability. However, these APIs are all described in Slice, so, to use these APIs, you need not learn any Python mapping rules beyond those we described here.

Chapter 25

Developing a File System Server in Python

25.1 Chapter Overview

In this chapter, we present the source code for a fully-functional Python server that implements the file system we developed in Chapter 5 (see Chapter 23 for the corresponding client).

25.2 Implementing a File System Server

We have now seen enough of the server-side Python mapping to implement a server for the file system we developed in Chapter 5. (You may find it useful to review the `Slice` definition for our file system in Section 5 before studying the source code.)

Our server is implemented in a single source file, `Server.py`, containing our server's main program as well as the definitions of our `Directory` and `File` servant subclasses.

25.2.1 The Server Main Program

Our server main program uses the `Ice.Application` class we discussed in Section 24.3.1. The `run` method installs a signal handler, creates an object

adapter, instantiates a few servants for the directories and files in the file system, and then activates the adapter. This leads to a main program as follows:

```
import sys, threading, Ice, Filesystem

# DirectoryI servant class ...
# FileI servant class ...

class Server(Ice.Application):
    def run(self, args):
        # Terminate cleanly on receipt of a signal
        #
        self.shutdownOnInterrupt()

        # Create an object adapter (stored in the _adapter
        # static members)
        #
        adapter = self.communicator().\
            createObjectAdapterWithEndpoints(
                "SimpleFilesystem", "default -p 10000")
        DirectoryI._adapter = adapter
        FileI._adapter = adapter

        # Create the root directory (with name "/" and no parent)
        #
        root = DirectoryI("/", None)

        # Create a file called "README" in the root directory
        #
        file = FileI("README", root)
        text = [ "This file system contains a collection of " +
                "poetry." ]
        try:
            file.write(text)
        except Filesystem.GenericError, e:
            print e.reason

        # Create a directory called "Coleridge"
        # in the root directory
        #
        coleridge = DirectoryI("Coleridge", root)

        # Create a file called "Kubla_Khan"
        # in the Coleridge directory
        #
        file = FileI("Kubla_Khan", coleridge)
```

```
text = [ "In Xanadu did Kubla Khan",
        "A stately pleasure-dome decree:",
        "Where Alph, the sacred river, ran",
        "Through caverns measureless to man",
        "Down to a sunless sea." ]

try:
    file.write(text)
except Filesystem.GenericError, e:
    print e.reason

# All objects are created, allow client requests now
#
adapter.activate()

# Wait until we are done
#
self.communicator().waitForShutdown()

if self.interrupted():
    print self.appName() + ": terminating"

return 0

app = Server()
sys.exit(app.main(sys.argv))
```

The code defines the `Server` class, which derives from `Ice.Application` and contains the main application logic in its `run` method. Much of this code is boiler plate that we saw previously: we create an object adapter, and, towards the end, activate the object adapter and call `waitForShutdown`.

The interesting part of the code follows the adapter creation: here, the server instantiates a few nodes for our file system to create the structure shown in Figure 25.1.

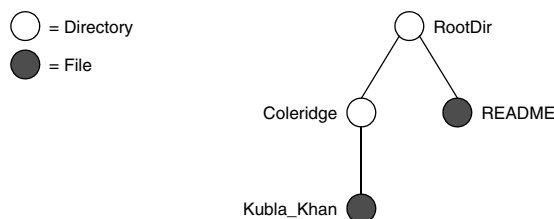

Figure 25.1. A small file system.

As we will see shortly, the servants for our directories and files are of type `DirectoryI` and `FileI`, respectively. The constructor for either type of servant accepts two parameters, the name of the directory or file to be created and a reference to the servant for the parent directory. (For the root directory, which has no parent, we pass `None`.) Thus, the statement

```
root = DirectoryI("/", None)
```

creates the root directory, with the name "/" and no parent directory.

Here is the code that establishes the structure in Figure 25.1:

```
# Create the root directory (with name "/" and no parent)
#
root = DirectoryI("/", None)

# Create a file called "README" in the root directory
#
file = FileI("README", root)
text = [ "This file system contains a collection of " +
        "poetry." ]
try:
    file.write(text)
except Filesystem.GenericError, e:
    print e.reason

# Create a directory called "Coleridge"
# in the root directory
#
coleridge = DirectoryI("Coleridge", root)

# Create a file called "Kubla_Khan"
# in the Coleridge directory
#
file = FileI("Kubla_Khan", coleridge)
text = [ "In Xanadu did Kubla Khan",
        "A stately pleasure-dome decree:",
        "Where Alph, the sacred river, ran",
        "Through caverns measureless to man",
        "Down to a sunless sea." ]
try:
    file.write(text)
except Filesystem.GenericError, e:
    print e.reason
```

We first create the root directory and a file `README` within the root directory. (Note that we pass a reference to the root directory as the parent when we create the new node of type `FileI`.)

The next step is to fill the file with text:

```
text = [ "This file system contains a collection of " +
        "poetry." ]
try:
    file.write(text)
except Filesystem.GenericError, e:
    print e.reason
```

Recall from Section 14.7.3 that `Slice` sequences map to Python lists. The `Slice` type `Lines` is simply a list of strings; we add a line of text to our `README` file by initializing the `text` list to contain one element.

Finally, we call the `Slice` `write` operation on our `FileI` servant by simply writing:

```
file.write(text)
```

This statement is interesting: the server code invokes an operation on one of its own servants. Because the call happens via a reference to the servant (of type `FileI`) and *not* via a proxy (of type `FilePrx`), the Ice run time does not know that this call is even taking place—such a direct call into a servant is not mediated by the Ice run time in any way and is dispatched as an ordinary Python method call.

In similar fashion, the remainder of the code creates a subdirectory called `Coleridge` and, within that directory, a file called `Kubla_Khan` to complete the structure in Figure 25.1.

25.2.2 The `FileI` Servant Class

Our `FileI` servant class has the following basic structure:

```
class FileI(Filesystem.File):
    # Constructor and operations here...

    _adapter = None
```

The class has a number of data members:

- `_adapter`

This class member stores a reference to the single object adapter we use in our server.

- `_name`
This instance member stores the name of the file incarnated by the servant.
- `_parent`
This instance member stores the reference to the servant for the file's parent directory.
- `_lines`
This instance member holds the contents of the file.

The `_name`, `_parent`, and `_lines` data members are initialized by the constructor:

```
def __init__(self, name, parent):
    self._name = name
    self._parent = parent
    self._lines = []

    assert(self._parent != None)

    # Create an identity
    #
    myID = Ice.stringToIdentity(Ice.generateUUID())

    # Add the identity to the object adapter
    #
    self._adapter.add(self, myID)

    # Create a proxy for the new node and
    # add it as a child to the parent
    #
    thisNode = Filesystem.NodePrx.uncheckedCast(
        self._adapter.createProxy(myID))
    self._parent.addChild(thisNode)
```

After initializing the instance members, the code verifies that the reference to the parent is not `None` because every file must have a parent directory. The constructor then generates an identity for the file by calling `Ice.generateUUID` and adds itself to the servant map by calling `ObjectAdapter.add`. Finally, the constructor creates a proxy for this file and calls the `addChild` method on its parent directory. `addChild` is a helper function that a child directory or file calls to add itself to the list of descendant nodes of its parent directory. We will see the implementation of this function on page 644.

The remaining methods of the `FileI` class implement the Slice operations we defined in the `Node` and `File Slice` interfaces:

```
# Slice Node::name() operation

def name(self, current=None):
    return self._name

# Slice File::read() operation

def read(self, current=None):
    return self._lines

# Slice File::write() operation

def write(self, text, current=None):
    self._lines = text
```

The `name` method is inherited from the generated `Node` class. It simply returns the value of the `_name` instance member.

The `read` and `write` methods are inherited from the generated `File` class and simply return and set the `_lines` instance member.

25.2.3 The DirectoryI Servant Class

The `DirectoryI` class has the following basic structure:

```
class DirectoryI(Filesystem.Directory):
    # Constructor and operations here...

    _adapter = None
```

As for the `FileI` class, we have data members to store the object adapter, the name, and the parent directory. (For the root directory, the `_parent` member holds `None`.) In addition, we have a `_contents` data member that stores the list of child directories. These data members are initialized by the constructor:

```
def __init__(self, name, parent):
    self._name = name
    self._parent = parent
    self._contents = []

    # Create an identity. The
    # parent has the fixed identity "RootDir"
    #
    if(self._parent):
```

```

        myID = Ice.stringToIdentity(Ice.generateUUID())
    else:
        myID = Ice.stringToIdentity("RootDir")

    # Add the identity to the object adapter
    #
    self._adapter.add(self, myID)

    # Create a proxy for the new node and
    # add it as a child to the parent
    #
    thisNode = Filesystem.NodePrx.uncheckedCast (
        self._adapter.createProxy(myID))
    if self._parent:
        self._parent.addChild(thisNode)

```

The constructor creates an identity for the new directory by calling `Ice.generateUUID`. (For the root directory, we use the fixed identity "RootDir".) The servant adds itself to the servant map by calling `ObjectAdapter.add` and then creates a proxy to itself and passes it to the `addChild` helper function.

`addChild` simply adds the passed reference to the `_contents` list:

```

def addChild(self, child):
    self._contents.append(child)

```

The remainder of the operations, `name` and `list`, are trivial:

```

def name(self, current=None):
    return self._name

def list(self, current=None):
    return self._contents

```

25.3 Thread Safety

The server code we developed in Section 25.2 is not quite correct as it stands: if two clients access the same file in parallel, each via a different thread, one thread may read the `_lines` data member while another thread updates it. Obviously, if that happens, we may write or return garbage or, worse, crash the server. However, we can make the read and write operations thread-safe with a few trivial changes to the `FileI` class:

```
def __init__(self, name, parent):
    self._name = name
    self._parent = parent
    self._lines = []
    self._mutex = threading.Lock()

    # ...

def name(self, current=None):
    return self._name

def read(self, current=None):
    self._mutex.acquire()
    lines = self._lines[:] # Copy the list
    self._mutex.release()
    return lines

def write(self, text, current=None):
    self._mutex.acquire()
    self._lines = text
    self._mutex.release()
```

We modified the constructor to add the instance member `_mutex`, and then enclosed our `read` and `write` implementations in a critical section. (The `name` method does not require a critical section because the file's name is immutable.)

No changes for thread safety are necessary in the `DirectoryI` class because the `Directory` interface, in its current form, defines no operations that modify the object.

25.4 Summary

This chapter showed how to implement a complete server for the file system we defined in Chapter 5. Note that the server is remarkably free of code that relates to distribution: most of the server code is simply application logic that would be present just the same as a non-distributed version. Again, this is one of the major advantages of Ice: distribution concerns are kept away from application code so that you can concentrate on developing application logic instead of networking infrastructure.

Part III.F

Ruby Mapping

Chapter 26

Client-Side Slice-to-Ruby Mapping

26.1 Chapter Overview

In this chapter, we present the client-side Slice-to-Ruby mapping. One part of the client-side Ruby mapping concerns itself with rules for representing each Slice data type as a corresponding Ruby type; we cover these rules in Section 26.3 to Section 26.10. Another part of the mapping deals with how clients can invoke operations, pass and receive parameters, and handle exceptions. These topics are covered in Section 26.11 to Section 26.13. Slice classes have the characteristics of both data types and interfaces and are covered in Section 26.14. Code generation issues are discussed in Section 26.15, while Section 26.16 addresses the use of Slice checksums.

26.2 Introduction

The client-side Slice-to-Ruby mapping defines how Slice data types are translated to Ruby types, and how clients invoke operations, pass parameters, and handle errors. Much of the Ruby mapping is intuitive. For example, Slice sequences map to Ruby arrays, so there is essentially nothing new you have learn in order to use Slice sequences in Ruby.

The Ruby API to the Ice run time is fully thread-safe. Obviously, you must still synchronize access to data from different threads. For example, if you have two threads sharing a sequence, you cannot safely have one thread insert into the sequence while another thread is iterating over the sequence. However, you only need to concern yourself with concurrent access to your own data—the Ice run time itself is fully thread safe, and none of the Ice API calls require you to acquire or release a lock before you safely can make the call.

Much of what appears in this chapter is reference material. We suggest that you skim the material on the initial reading and refer back to specific sections as needed. However, we recommend that you read at least Section 26.11 to Section 26.13 in detail because these sections cover how to call operations from a client, pass parameters, and handle exceptions.

A word of advice before you start: in order to use the Ruby mapping, you should need no more than the Slice definition of your application and knowledge of the Ruby mapping rules. In particular, looking through the generated code in order to discern how to use the Ruby mapping is likely to be inefficient, due to the amount of detail. Of course, occasionally, you may want to refer to the generated code to confirm a detail of the mapping, but we recommend that you otherwise use the material presented here to see how to write your client-side code.

26.3 Mapping for Identifiers

Slice identifiers map to an identical Ruby identifier. For example, the Slice identifier `Clock` becomes the Ruby identifier `Clock`. There are two exceptions to this rule:

1. If a Slice identifier maps to the name of a Ruby class, module, or constant, and the Slice identifier does not begin with an upper case letter, the mapping replaces the leading character with its upper case equivalent.¹ For example, the Slice identifier `bankAccount` is mapped as `BankAccount`.
2. If a Slice identifier is the same as a Ruby keyword, the corresponding Ruby identifier is prefixed with an underscore. For example, the Slice identifier `while` is mapped as `_while`.²

1. Ruby requires the names of classes, modules, and constants to begin with an upper case letter.

2. As suggested in Section 4.5.3 on page 86, you should try to avoid such identifiers as much as possible.

26.4 Mapping for Modules

Slice modules map to Ruby modules with the same name as the Slice module. The mapping preserves the nesting of the Slice definitions.

26.5 The `Ice` Module

All of the APIs for the Ice run time are nested in the `Ice` module, to avoid clashes with definitions for other libraries or applications. Some of the contents of the `Ice` module are generated from Slice definitions; other parts of the `Ice` module provide special-purpose definitions that do not have a corresponding Slice definition. We will incrementally cover the contents of the `Ice` module throughout the remainder of the book.

26.6 Mapping for Simple Built-In Types

The Slice built-in types are mapped to Ruby types as shown in Table 26.1.

Table 26.1. Mapping of Slice built-in types to Ruby.

Slice	Ruby
<code>bool</code>	true or false
<code>byte</code>	Fixnum
<code>short</code>	Fixnum
<code>int</code>	Fixnum or Bignum
<code>long</code>	Fixnum or Bignum
<code>float</code>	Float
<code>double</code>	Float
<code>string</code>	String

Although Ruby supports arbitrary precision in its integer types, the Ice run time validates integer values to ensure they have valid ranges for their declared Slice types.

26.7 Mapping for User-Defined Types

Slice supports user-defined types: enumerations, structures, sequences, and dictionaries.

26.7.1 Mapping for Enumerations

Ruby does not have an enumerated type, so the Slice enumerations are emulated using a Ruby class: the name of the Slice enumeration becomes the name of the Ruby class; for each enumerator, the class contains a constant with the same name as the enumerator (see Section 26.3 for more information on identifiers). For example:

```
enum Fruit { Apple, Pear, Orange };
```

The generated Ruby class looks as follows:

```
class Fruit
  include Comparable

  Apple = # ...
  Pear = # ...
  Orange = # ...

  def Fruit.from_int(val)

  def to_i

  def to_s

  def <=>(other)

  def hash

  # ...
end
```

The compiler generates a class constant for each enumerator that holds a corresponding instance of `Fruit`. The `from_int` class method returns an instance given its integer value, while `to_i` returns the integer value of an enumerator and `to_s` returns its `Slice` identifier. The comparison operators are available as a result of including `Comparable`, which means a program can compare enumerators according to their integer values.

Given the above definitions, we can use enumerated values as follows:

```
f1 = Fruit::Apple
f2 = Fruit::Orange

if f1 == Fruit::Apple # Compare for equality
  # ...

if f1 < f2             # Compare two enums
  # ...

case f2
when Fruit::Orange
  puts "found Orange"
else
  puts "found #{f2.to_s}"
end
```

As you can see, the generated class enables natural use of enumerated values.

26.7.2 Mapping for Structures

`Slice` structures map to Ruby classes with the same name. For each `Slice` data member, the Ruby class contains a corresponding instance variable as well as accessors to read and write its value. For example, here is our `Employee` structure from Section 4.9.4 once more:

```
struct Employee {
  long number;
  string firstName;
  string lastName;
};
```

The Ruby mapping generates the following definition for this structure:

```
class Employee
  def initialize(number=0, firstName='', lastName='')
    @number = number
    @firstName = firstName
  end
end
```

```

        @lastName = lastName
    end
    def hash
        # ...
    end
    attr_accessor :number, :firstName, :lastName
end

```

The constructor initializes each of the instance variables to a default value appropriate for its type. The compiler also generates a definition for the `hash` method, which allows instances to be used as keys in a hash collection.

26.7.3 Mapping for Sequences

Slice sequences map to Ruby arrays. This means that the Ruby mapping does not generate a separate named type for a Slice sequence. It also means that you can take advantage of all the array functionality provided by Ruby. For example:

```
sequence<Fruit> FruitPlatter;
```

We can use the `FruitPlatter` sequence as shown below:

```
platter = [ Fruit::Apple, Fruit::Pear ]
platter.push(Fruit::Orange)
```

The Ice run time validates the elements of a sequence to ensure that they are compatible with the declared type; a `TypeError` exception is raised if an incompatible type is encountered.

26.7.4 Mapping for Dictionaries

Here is the definition of our `EmployeeMap` from Section 4.9.4 once more:

```
dictionary<long, Employee> EmployeeMap;
```

As for sequences, the Ruby mapping does not create a separate named type for this definition. Instead, *all* dictionaries are simply instances of Ruby's hash collection type. For example:

```
em = {}

e = Employee.new
e.number = 31
```

```
e.firstName = "James"  
e.lastName = "Gosling"
```

```
em[e.number] = e
```

The Ice run time validates the elements of a dictionary to ensure that they are compatible with the declared type; a `TypeError` exception is raised if an incompatible type is encountered.

26.8 Mapping for Constants

Here are the constant definitions we saw in Section 4.9.5 on page 97 once more:

```
const bool      AppendByDefault = true;  
const byte      LowerNibble = 0x0f;  
const string    Advice = "Don't Panic!";  
const short     TheAnswer = 42;  
const double    PI = 3.1416;
```

```
enum Fruit { Apple, Pear, Orange };  
const Fruit    FavoriteFruit = Pear;
```

The generated definitions for these constants are shown below:

```
AppendByDefault = true  
LowerNibble = 15  
Advice = "Don't Panic!"  
TheAnswer = 42  
PI = 3.1416  
FavoriteFruit = Fruit::Pear
```

As you can see, each Slice constant is mapped to a Ruby constant with the same name.

26.9 Mapping for Exceptions

The mapping for exceptions is based on the inheritance hierarchy shown in Figure 26.1

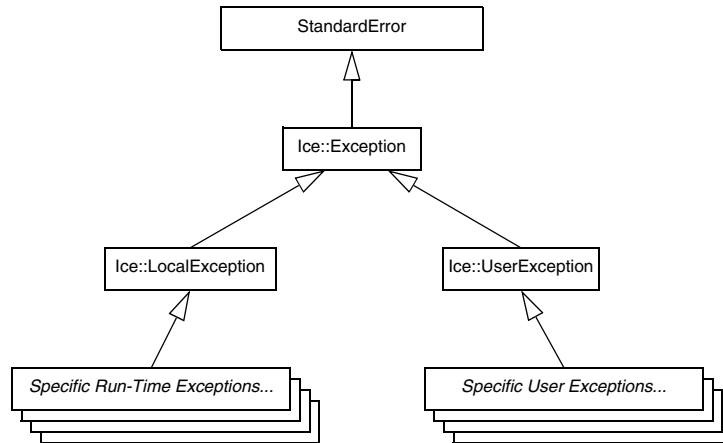

Figure 26.1. Inheritance structure for Ice exceptions.

The ancestor of all exceptions is `StandardError`, from which `Ice::Exception` is derived. `Ice::LocalException` and `Ice::UserException` are derived from `Ice::Exception` and form the base for all run-time and user exceptions.

Here is a fragment of the Slice definition for our world time server from Section 4.10.5 on page 113 once more:

```

exception GenericError {
    string reason;
};
exception BadTimeVal extends GenericError {};
exception BadZoneName extends GenericError {};
  
```

These exception definitions map to the abbreviated Ruby class definitions shown below:

```

class GenericError < Ice::UserException
  def initialize(reason='')

  def to_s
  
```

```
    def inspect

      attr_accessor :reason
    end

class BadTimeVal < GenericError
  def initialize(reason='')

    def to_s

      def inspect
    end

class BadZoneName < GenericError
  def initialize(reason='')

    def to_s

      def inspect
    end
end
```

Each Slice exception is mapped to a Ruby class with the same name. The inheritance structure of the Slice exceptions is preserved for the generated classes, so `BadTimeVal` and `BadZoneName` inherit from `GenericError`.

Each exception member corresponds to an instance variable of the instance, which the constructor initializes to a default value appropriate for its type. Accessors are provided to read and write the data members.

Although `BadTimeVal` and `BadZoneName` do not declare data members, their constructors still accept a value for the inherited data member `reason` in order to pass it to the constructor of the base exception `GenericError`.

Each exception also defines the standard methods `to_s` and `inspect` to return the name of the exception and a stringified representation of the exception and its members, respectively.

All user exceptions are derived from the base class `Ice::UserException`. This allows you to catch all user exceptions generically by installing a handler for `Ice::UserException`. Similarly, you can catch all Ice run-time exceptions with a handler for `Ice::LocalException`, and you can catch all Ice exceptions with a handler for `Ice::Exception`.

26.10 Mapping for Run-Time Exceptions

The Ice run time throws run-time exceptions for a number of pre-defined error conditions. All run-time exceptions directly or indirectly derive from `Ice::LocalException` (which, in turn, derives from `Ice::Exception`).

An inheritance diagram for user and run-time exceptions appears in Figure 4.4 on page 110. By catching exceptions at the appropriate point in the hierarchy, you can handle exceptions according to the category of error they indicate:

- `Ice::LocalException`
This is the root of the inheritance tree for run-time exceptions.
- `Ice::UserException`
This is the root of the inheritance tree for user exceptions.
- `Ice::TimeoutException`
This is the base exception for both operation-invocation and connection-establishment timeouts.
- `Ice::ConnectTimeoutException`
This exception is raised when the initial attempt to establish a connection to a server times out.

You will probably have little need to catch the remaining exceptions by category; the fine-grained error handling offered by the remainder of the hierarchy is of interest mainly in the implementation of the Ice run time. However, there is one exception you will probably be interested in specifically:

`Ice::ObjectNotExistException`. This exception is raised if a client invokes an operation on an Ice object that no longer exists. In other words, the client holds a dangling reference to an object that probably existed some time in the past but has since been permanently destroyed.

26.11 Mapping for Interfaces

The mapping of Slice interfaces revolves around the idea that, to invoke a remote operation, you call a method on a local class instance that represents the remote object. This makes the mapping easy and intuitive to use because, for all intents and purposes (apart from error semantics), making a remote procedure call is no different from making a local procedure call.

26.11.1 Proxy Classes

On the client side, Slice interfaces map to Ruby classes with methods that correspond to the operations on those interfaces. Consider the following simple interface:

```
interface Simple {
  void op();
};
```

The Ruby mapping generates the following definition for use by the client:

```
class SimplePrx < Ice::ObjectPrx
  def op(_ctx=nil)
    # ...

    # ...
  end
end
```

In the client's address space, an instance of `SimplePrx` is the local ambassador for a remote instance of the `Simple` interface in a server and is known as a *proxy instance*. All the details about the server-side object, such as its address, what protocol to use, and its object identity are encapsulated in that instance.

Note that `SimplePrx` inherits from `Ice::ObjectPrx`. This reflects the fact that all Ice interfaces implicitly inherit from `Ice::Object`.

For each operation in the interface, the proxy class has a method of the same name. In the preceding example, we find that the operation `op` has been mapped to the method `op`. Note that `op` accepts an optional trailing parameter `_ctx` representing the operation context. This parameter is a Ruby hash value for use by the Ice run time to store information about how to deliver a request. You normally do not need to use it. (We examine the context parameter in detail in Chapter 31. The parameter is also used by `IceStorm`—see Chapter 43.)

Proxy instances are always created on behalf of the client by the Ice run time, so client code never has any need to instantiate a proxy directly.

26.11.2 The `Ice::ObjectPrx` Class

All Ice objects have `Object` as the ultimate ancestor type, so all proxies inherit from `Ice::ObjectPrx`. `ObjectPrx` provides a number of methods:

```
class ObjectPrx
  def eql?(proxy)
  def ice_getIdentity
  def ice_getHash
```

```

    def ice_isA(id)
    def ice_id
    def ice_ping
    # ...
end

```

The methods behave as follows:

- `eql?`

The implementation of this standard method compares two proxies for equality. Note that all aspects of proxies are compared by this operation, such as the communication endpoints for the proxy. This means that, in general, if two proxies compare unequal, that does *not* imply that they denote different objects. For example, if two proxies denote the same Ice object via different transport endpoints, `eql?` returns `false` even though the proxies denote the same object.

- `ice_getIdentity`

This method returns the identity of the object denoted by the proxy. The identity of an Ice object has the following Slice type:

```

module Ice {
    struct Identity {
        string name;
        string category;
    };
};

```

To see whether two proxies denote the same object, first obtain the identity for each object and then compare the identities:

```

proxy1 = ...
proxy2 = ...
id1 = proxy1.ice_getIdentity
id2 = proxy2.ice_getIdentity

if id1 == id2
    # proxy1 and proxy2 denote the same object
else
    # proxy1 and proxy2 denote different objects
end

```

- `ice_getHash`

This method is an alias for `hash` and returns an integer hash key for the proxy.

- `ice_isA`

This method determines whether the object denoted by the proxy supports a specific interface. The argument to `ice_isA` is a type ID (see Section 4.13). For example, to see whether a proxy of type `ObjectPrx` denotes a `Printer` object, we can write:

```
proxy = ...
if proxy && proxy.ice_isA("::Printer")
  # proxy denotes a Printer object
else
  # proxy denotes some other type of object
end
```

Note that we are testing whether the proxy is `nil` before attempting to invoke the `ice_isA` method. This avoids getting a run-time error if the proxy is `nil`.

- `ice_id`

This method returns the type ID of the object denoted by the proxy. Note that the type returned is the type of the actual object, which may be more derived than the static type of the proxy. For example, if we have a proxy of type `BasePrx`, with a static type ID of `::Base`, the return value of `ice_id` might be `::Base`, or it might be something more derived, such as `::Derived`.

- `ice_ping`

This method provides a basic reachability test for the object. If the object can physically be contacted (that is, the object exists and its server is running and reachable), the call completes normally; otherwise, it throws an exception that indicates why the object could not be reached, such as

`ObjectNotExistException` or `ConnectTimeoutException`.

Note that there are other methods in `ObjectPrx`, not shown here. These methods provide different ways to dispatch a call. (We discuss these methods in Chapter 31.)

26.11.3 Casting Proxies

The Ruby mapping for a proxy also generates two class methods:

```

class SimplePrx < Ice::ObjectPrx
  # ...

  def SimplePrx.checkedCast(proxy, facet='', ctx={})

  def SimplePrx.uncheckedCast(proxy, facet='')
end

```

Both the `checkedCast` and `uncheckedCast` methods implement a down-cast: if the passed proxy is a proxy for an object of type `Simple`, or a proxy for an object with a type derived from `Simple`, the cast returns a reference to a proxy of type `SimplePrx`; otherwise, if the passed proxy denotes an object of a different type (or if the passed proxy is `nil`), the cast returns `nil`.

The method names `checkedCast` and `uncheckedCast` are reserved for use in proxies. If a Slice interface defines an operation with either of those names, the mapping escapes the name in the generated proxy by prepending an underscore. For example, an interface that defines an operation named `checkedCast` is mapped to a proxy with a method named `_checkedCast`.

Given a proxy of any type, you can use a `checkedCast` to determine whether the corresponding object supports a given type, for example:

```

obj = ...          # Get a proxy from somewhere...

simple = SimplePrx::checkedCast(obj)
if simple
  # Object supports the Simple interface...
else
  # Object is not of type Simple...
end

```

Note that a `checkedCast` contacts the server. This is necessary because only the server implementation has definite knowledge of the type of an object. As a result, a `checkedCast` may throw a `ConnectTimeoutException` or an `ObjectNotExistException`.

In contrast, an `uncheckedCast` does not contact the server and unconditionally returns a proxy of the requested type. However, if you do use an `uncheckedCast`, you must be certain that the proxy really does support the type you are casting to; otherwise, if you get it wrong, you will most likely get a run-time exception when you invoke an operation on the proxy. The most likely error for such a type mismatch is `OperationNotExistException`. However, other exceptions, such as a marshaling exception are possible as well. And, if the object happens to have an operation with the correct name, but

different parameter types, no exception may be reported at all and you simply end up sending the invocation to an object of the wrong type; that object may do rather non-sensical things. To illustrate this, consider the following two interfaces:

```
interface Process {
    void launch(int stackSize, int dataSize);
};

// ...

interface Rocket {
    void launch(float xCoord, float yCoord);
};
```

Suppose you expect to receive a proxy for a `Process` object and use an `uncheckedCast` to down-cast the proxy:

```
obj = ... # Get proxy...
process = ProcessPrx::uncheckedCast(obj) # No worries...
process.launch(40, 60) # Oops...
```

If the proxy you received actually denotes a `Rocket` object, the error will go undetected by the Ice run time: because `int` and `float` have the same size and because the Ice protocol does not tag data with its type on the wire, the implementation of `Rocket::launch` will simply misinterpret the passed integers as floating-point numbers.

In fairness, this example is somewhat contrived. For such a mistake to go unnoticed at run time, both objects must have an operation with the same name and, in addition, the run-time arguments passed to the operation must have a total marshaled size that matches the number of bytes that are expected by the unmarshaling code on the server side. In practice, this is extremely rare and an incorrect `uncheckedCast` typically results in a run-time exception.

26.12 Mapping for Operations

As we saw in Section 26.11, for each operation on an interface, the proxy class contains a corresponding method with the same name. To invoke an operation, you call it via the proxy. For example, here is part of the definitions for our file system from Section 5.4:

```

module Filesystem {
  interface Node {
    nonmutating string name();
  };
  // ...
};

```

The `name` operation returns a value of type `string`. Given a proxy to an object of type `Node`, the client can invoke the operation as follows:

```

node = ...           # Initialize proxy
name = node.name()  # Get name via RPC

```

26.12.1 Normal, idempotent, and nonmutating Operations

You can add an `idempotent` or `nonmutating` qualifier to a Slice operation. As far as the signature for the corresponding proxy methods is concerned, neither `idempotent` nor `nonmutating` have any effect. For example, consider the following interface:

```

interface Example {
  string op1();
  idempotent string op2();
  nonmutating string op3();
};

```

The proxy class for this is:

```

class ExamplePrx < Ice::ObjectPrx
  def op1(_ctx=nil)

  def op2(_ctx=nil)

  def op3(_ctx=nil)
end

```

`idempotent` and `nonmutating` affect an aspect of call dispatch, not interface, so it makes sense for the three methods to look the same.

26.12.2 Passing Parameters

In Parameters

All parameters are passed by reference in the Ruby mapping; it is guaranteed that the value of a parameter will not be changed by the invocation.

Here is an interface with operations that pass parameters of various types from client to server:

```
struct NumberAndString {
    int x;
    string str;
};

sequence<string> StringSeq;

dictionary<long, StringSeq> StringTable;

interface ClientToServer {
    void op1(int i, float f, bool b, string s);
    void op2(NumberAndString ns, StringSeq ss, StringTable st);
    void op3(ClientToServer* proxy);
};
```

The Slice compiler generates the following proxy for this definition:

```
class ClientToServerPrx < Ice::ObjectPrx
    def op1(i, f, b, s, _ctx=nil)

    def op2(ns, ss, st, _ctx=nil)

    def op3(proxy, _ctx=nil)
end
```

Given a proxy to a `ClientToServer` interface, the client code can pass parameters as in the following example:

```
p = ... # Get proxy...

p.op1(42, 3.14, true, "Hello world!") # Pass simple literals

i = 42
f = 3.14
b = True
s = "Hello world!"
p.op1(i, f, b, s) # Pass simple variables

ns = NumberAndString.new()
ns.x = 42
ns.str = "The Answer"
ss = [ "Hello world!" ]
st = {}
```

```

st[0] = ns
p.op2(ns, ss, st)                # Pass complex variables

p.op3(p)                        # Pass proxy

```

Out Parameters

As in Java, Ruby functions do not support reference arguments. That is, it is not possible to pass an uninitialized variable to a Ruby function in order to have its value initialized by the function. The Java mapping (see Section 10.12.2) overcomes this limitation with the use of “holder classes” that represent each out parameter. The Ruby mapping takes a different approach, one that is more natural for Ruby users.

The semantics of out parameters in the Ruby mapping depend on whether the operation returns one value or multiple values. An operation returns multiple values when it has declared multiple out parameters, or when it has declared a non-void return type and at least one out parameter.

If an operation returns multiple values, the client receives them in the form of a *result array*. A non-void return value, if any, is always the first element in the result array, followed by the out parameters in the order of declaration.

If an operation returns only one value, the client receives the value itself.

Here is the same Slice definition we saw on page 664 once more, but this time with all parameters being passed in the out direction:

```

struct NumberAndString {
    int x;
    string str;
};

sequence<string> StringSeq;

dictionary<long, StringSeq> StringTable;

interface ClientToServer {
    int op1(out float f, out bool b, out string s);
    void op2(out NumberAndString ns,
            out StringSeq ss,
            out StringTable st);
    void op3(out ClientToServer* proxy);
};

```

The Ruby mapping generates the following code for this definition:

```
class ClientToServerPrx < Ice::ObjectPrx
  def op1(_ctx=nil)

  def op2(_ctx=nil)

  def op3(_ctx=nil)
end
```

Given a proxy to a `ServerToClient` interface, the client code can receive the results as in the following example:

```
p = ... # Get proxy...
i, f, b, s = p.op1()
ns, ss, st = p.op2()
stcp = p.op3()
```

The operations have no in parameters, therefore no arguments are passed to the proxy methods. Since `op1` and `op2` return multiple values, their result arrays are unpacked into separate values, whereas the return value of `op3` requires no unpacking.

Parameter Type Mismatches

Although the Ruby compiler cannot check the types of arguments passed to a method, the Ice run time does perform validation on the arguments to a proxy invocation and reports any type mismatches as a `TypeError` exception.

Null Parameters

Some Slice types naturally have “empty” or “not there” semantics. Specifically, proxies, sequences, dictionaries, and strings all can be null:

- For proxies, a value of `nil` denotes the null proxy. The null proxy is a dedicated value that indicates that a proxy points “nowhere” (denotes no object).
- Sequences and dictionaries cannot be null, but can be empty. To make life with these types easier, whenever you pass `nil` as a parameter or return value of type sequence or dictionary, the Ice run time automatically sends an empty sequence or dictionary to the receiver.
- Slice strings cannot be null, but can be empty. Whenever you pass `nil` as a parameter or return value, the Ice run time automatically sends an empty string to the receiver.

This behavior is useful as a convenience feature: especially for deeply-nested data types, members that are sequences, dictionaries, or strings automatically arrive as an empty value at the receiving end. This saves you having to explicitly initialize,

for example, every string element in a large sequence before sending it in order to avoid a run-time error. Note that using null parameters in this way does *not* create null semantics for sequences, dictionaries, or strings. As far as the object model is concerned, these do not exist (only *empty* sequences, dictionaries, and strings do). For example, it makes no difference to the receiver whether you send a string as `nil` or as an empty string: either way, the receiver sees an empty string.

26.13 Exception Handling

Any operation invocation may throw a run-time exception (see Section 26.10) and, if the operation has an exception specification, may also throw user exceptions (see Section 26.9). Suppose we have the following simple interface:

```
exception Tantrum {
  string reason;
};

interface Child {
  void askToCleanUp() throws Tantrum;
};
```

Slice exceptions are thrown as Ruby exceptions, so you can simply enclose one or more operation invocations in a `try-except` block:

```
child = ...          # Get child proxy...

begin
  child.askToCleanUp()
rescue Tantrum => t
  puts "The child says: #{t.reason}"
end
```

Typically, you will catch only a few exceptions of specific interest around an operation invocation; other exceptions, such as unexpected run-time errors, will usually be handled by exception handlers higher in the hierarchy. For example:

```
def run()
  child = ...          # Get child proxy...
  begin
    child.askToCleanUp()
  rescue Tantrum => t
    puts "The child says: #{t.reason}"
    child.scold()      # Recover from error...
  end
end
```

```
        end
        child.praise()      # Give positive feedback...
    end

begin
    # ...
    run()
    # ...
rescue Ice::Exception => ex
    print ex.backtrace.join("\n")
end
```

This code handles a specific exception of local interest at the point of call and deals with other exceptions generically. (This is also the strategy we used for our first simple application in Chapter 3.)

26.14 Mapping for Classes

Slice classes are mapped to Ruby classes with the same name. For each Slice data member, the generated class contains an instance variable and accessors to read and write it, just as for structures and exceptions. Consider the following class definition:

```
class TimeOfDay {
    short hour;           // 0 - 23
    short minute;        // 0 - 59
    short second;        // 0 - 59
    string format();     // Return time as hh:mm:ss
};
```

The Ruby mapping generates the following code for this definition:

```
module TimeOfDay_mixin
    include ::Ice::Object_mixin

    # ...

    def inspect
        # ...
    end

    #
    # Operation signatures.
    #
```

```

    # def format()

    attr_accessor :hours, :minutes, :seconds
end
class TimeOfDay
  include TimeOfDay_mixin

  def initialize(hour=0, minute=0, second=0)
    @hour = hour
    @minute = minute
    @second = second
  end

  # ...
end

```

There are a number of things to note about the generated code:

1. The generated class `TimeOfDay` includes the mixin module `TimeOfDay_mixin`, which in turn includes `Ice::Object_mixin`. This reflects the semantics of Slice classes in that all classes implicitly inherit from `Object`, which is the ultimate ancestor of all classes. Note that `Object` is *not* the same as `Ice::ObjectPrx`. In other words, you *cannot* pass a class where a proxy is expected and vice versa.
2. The constructor defines an instance variable for each Slice data member.
3. A comment summarizes the method signatures for each Slice operation.

There is quite a bit to discuss here, so we will look at each item in turn.

26.14.1 Inheritance from `Object`

In other language mappings, the inheritance relationship between `Object` and a user-defined Slice class is stated explicitly, in that the generated class derives from a language-specific representation of `Object`. Although its class type allows single inheritance, Ruby's loosely-typed nature places less emphasis on class hierarchies and relies more on *duck typing*.³

The Slice mapping for a class follows this convention by placing most of the necessary machinery in a mixin module that the generated class includes into its

3. In Ruby, an object's type is typically less important than the methods it supports. "If it looks like a duck, and acts like a duck, then it *is* a duck."

definition. The Ice run time requires an instance of a Slice class to include the mixin module and define values for the declared data members, but does not require that the object be an instance of the generated class.

As shown in Figure 26.2, classes have no relationship to `Ice::ObjectPrx` (which is at the base of the inheritance hierarchy for proxies), therefore you cannot pass a class where a proxy is expected (and vice versa).

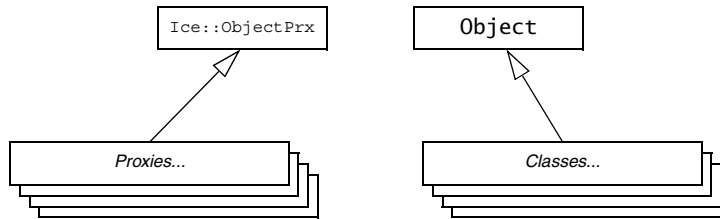

Figure 26.2. Inheritance from `Ice::ObjectPrx` and `Object`.

An instance of a Slice class supports a number of methods:

```

def ice_isA(id, current=nil)

def ice_ping(current=nil)

def ice_ids(current=nil)

def ice_id(current=nil)

def ice_preMarshal()

def ice_postUnmarshal()
  
```

The methods behave as follows:

- `ice_isA`
This method returns `true` if the object supports the given type ID, and `false` otherwise.
- `ice_ping`
As for interfaces, `ice_ping` provides a basic reachability test for the class.
- `ice_ids`
This method returns a string sequence representing all of the type IDs supported by this object, including `::Ice::Object`.

- `ice_id`
This method returns the actual run-time type ID for a class. If you call `ice_id` through a reference to a base instance, the returned type id is the actual (possibly more derived) type ID of the instance.
- `ice_preMarshal`
If the object supports this method, the Ice run time invokes it just prior to marshaling the object's state, providing the opportunity for the object to validate its declared data members.
- `ice_postUnmarshal`
If the object supports this method, the Ice run time invokes it after unmarshaling the object's state. An object typically defines this method when it needs to perform additional initialization using the values of its declared data members.

The mixin module `Ice::Object_mixin` supplies default definitions of `ice_isA` and `ice_ping`, and the mixin module generated for each class defines `ice_ids` and `ice_id`.

26.14.2 Data Members of Classes

Data members of classes are mapped exactly as for structures and exceptions: for each data member in the Slice definition, the generated class contains a corresponding instance variable and accessor methods.

26.14.3 Operations of Classes

Operations of classes are mapped to methods in the generated class. This means that, if a class contains operations (such as the `format` operation of our `TimeOfDay` class), objects representing instances of `TimeOfDay` must define equivalent methods. For example:

```
class TimeOfDayI < TimeOfDay
  def format(current=nil)
    sprintf("%02d:%02d:%02d", @hour, @minute, @second)
  end
end
```

In this case our implementation class `TimeOfDayI` derives from the generated class `TimeOfDay`. An alternative is to include the generated mixin module,

which makes it possible for the class to derive from a different base class if necessary:

```
class TimeOfDayI < SomeOtherClass
  include TimeOfDay_mixin

  def format(current=nil)
    sprintf("%02d:%02d:%02d", @hour, @minute, @second)
  end
end
```

As described in Section 26.14.1, an implementation of a Slice class must include the mixin module but is not required to derive from the generated class.

A Slice class such as `TimeOfDay` that declares or inherits an operation is inherently abstract. Ruby does not support the notion of abstract classes or abstract methods, therefore the mapping merely summarizes the required method signatures in a comment for your convenience.

You may notice that the mapping for an operation adds an optional trailing parameter named `current`. For now, you can ignore this parameter and pretend it does not exist. (We look at it in more detail in Section 31.6.)

26.14.4 Class Factories

Having created a class such as this, we have an implementation and we can instantiate the `TimeOfDayI` class, but we cannot receive it as the return value or as an out-parameter from an operation invocation. To see why, consider the following simple interface:

```
interface Time {
  TimeOfDay get();
};
```

When a client invokes the `get` operation, the Ice run time must instantiate and return an instance of the `TimeOfDay` class. However, `TimeOfDay` is an abstract class that cannot be instantiated. Unless we tell it, the Ice run time cannot magically know that we have created a `TimeOfDayI` class that implements the abstract `format` operation of the `TimeOfDay` abstract class. In other words, we must provide the Ice run time with a factory that knows that the `TimeOfDay` abstract class has a `TimeOfDayI` concrete implementation. The `Ice::Communicator` interface provides us with the necessary operations:

```

module Ice {
  local interface ObjectFactory {
    Object create(string type);
    void destroy();
  };

  local interface Communicator {
    void addObjectFactory(ObjectFactory factory, string id);
    ObjectFactory findObjectFactory(string id);
    // ...
  };
};

```

To supply the Ice run time with a factory for our `TimeOfDayI` class, we must create an object that supports the `Ice::ObjectFactory` interface:

```

class ObjectFactory
  def create(type)
    fail unless type == "::M::TimeOfDay"
    TimeOfDayI.new
  end

  def destroy
    # Nothing to do
  end
end

```

The object factory's `create` method is called by the Ice run time when it needs to instantiate a `TimeOfDay` class. The factory's `destroy` method is called by the Ice run time when its communicator is destroyed.

The `create` method is passed the type ID (see Section 4.13) of the class to instantiate. For our `TimeOfDay` class, the type ID is `"::M::TimeOfDay"`. Our implementation of `create` checks the type ID: if it is `"::M::TimeOfDay"`, it instantiates and returns a `TimeOfDayI` object. For other type IDs, it fails because it does not know how to instantiate other types of objects.

Given a factory implementation, such as our `ObjectFactory`, we must inform the Ice run time of the existence of the factory:

```

ic = ... # Get Communicator...
ic.addObjectFactory(ObjectFactory.new, "::M::TimeOfDay")

```

Now, whenever the Ice run time needs to instantiate a class with the type ID `"::M::TimeOfDay"`, it calls the `create` method of the registered `ObjectFactory` instance.

The `destroy` operation of the object factory is invoked by the Ice run time when the communicator is destroyed. This gives you a chance to clean up any resources that may be used by your factory. Do not call `destroy` on the factory while it is registered with the communicator—if you do, the Ice run time has no idea that this has happened and, depending on what your `destroy` implementation is doing, may cause undefined behavior when the Ice run time tries to next use the factory.

The run time guarantees that `destroy` will be the last call made on the factory, that is, `create` will not be called concurrently with `destroy`, and `create` will not be called once `destroy` has been called. However, calls to `create` can be made concurrently.

Note that you cannot register a factory for the same type ID twice: if you call `addObjectFactory` with a type ID for which a factory is registered, the Ice run time throws an `AlreadyRegisteredException`.

Finally, keep in mind that if a class has only data members, but no operations, you need not create and register an object factory to transmit instances of such a class. Only if a class has operations do you have to define and register an object factory.

26.15 Code Generation

The Ruby mapping supports two forms of code generation: dynamic and static.

26.15.1 Dynamic Code Generation

Using dynamic code generation, Slice files are “loaded” at run time and dynamically translated into Ruby code, which is immediately compiled and available for use by the application. This is accomplished using the `Ice::loadSlice` method, as shown in the following example:

```
Ice::loadSlice("Color.ice")
puts "My favorite color is #{M::Color.blue.to_s}"
```

For this example, we assume that `Color.ice` contains the following definitions:

```
module M {
  enum Color { red, green, blue };
};
```

Ice::loadSlice Options

The `Ice::loadSlice` method behaves like a Slice compiler in that it accepts command-line arguments for specifying preprocessor options and controlling code generation. The arguments must include at least one Slice file.

The function has the following Ruby definition:

```
def loadSlice(cmd, args=[])
```

The command-line arguments can be specified entirely in the first argument, `cmd`, which must be a string. The optional second argument can be used to pass additional command-line arguments as a list; this is useful when the caller already has the arguments in list form. The function always returns `nil`.

For example, the following calls to `Ice::loadSlice` are functionally equivalent:

```
Ice::loadSlice("-I/opt/IceRuby/slice Color.ice")
Ice::loadSlice("-I/opt/IceRuby/slice", ["Color.ice"])
Ice::loadSlice("", ["-I/opt/IceRuby/slice", "Color.ice"])
```

In addition to the standard compiler options described in Section 4.19, `Ice::loadSlice` also supports the following command-line options:

- **--all**
Generate code for all Slice definitions, including those from included files.
- **--checksum**
Generate checksums for Slice definitions. See Section 26.16 for more information.

Loading Multiple Files

You can specify as many Slice files as necessary in a single invocation of `Ice::loadSlice`, as shown below:

```
Ice::loadSlice("Syscall.ice Process.ice")
```

Alternatively, you can call `Ice::loadSlice` several times:

```
Ice::loadSlice("Syscall.ice")
Ice::loadSlice("Process.ice")
```

If a Slice file includes another file, the default behavior of `Ice::loadSlice` generates Ruby code only for the named file. For example, suppose `Syscall.ice` includes `Process.ice` as follows:

```
// Syscall.ice
#include <Process.ice>
...
```

If you call `Ice::loadSlice("-I. Syscall.ice")`, Ruby code is not generated for the `Slice` definitions in `Process.ice` or for any definitions that may be included by `Process.ice`. If you also need code to be generated for included files, one solution is to load them individually in subsequent calls to `Ice::loadSlice`. However, it is much simpler, not to mention more efficient, to use the `--all` option instead:

```
Ice::loadSlice("--all -I. Syscall.ice")
```

When you specify `--all`, `Ice::loadSlice` generates Ruby code for all `Slice` definitions included directly or indirectly from the named `Slice` files.

There is no harm in loading a `Slice` file multiple times, aside from the additional overhead associated with code generation. For example, this situation could arise when you need to load multiple top-level `Slice` files that happen to include a common subset of nested files. Suppose that we need to load both `Syscall.ice` and `Kernel.ice`, both of which include `Process.ice`. The simplest way to load both files is with a single call to `Ice::loadSlice`:

```
Ice::loadSlice("--all -I. Syscall.ice Kernel.ice")
```

Although this invocation causes the `Ice` extension to generate code twice for `Process.ice`, the generated code is structured so that the interpreter ignores duplicate definitions. We could have avoided generating unnecessary code with the following sequence of steps:

```
Ice::loadSlice("--all -I. Syscall.ice")
Ice::loadSlice("-I. Kernel.ice")
```

In more complex cases, however, it can be difficult or impossible to completely avoid this situation, and the overhead of code generation is usually not significant enough to justify such an effort.

26.15.2 Static Code Generation

You should be familiar with static code generation if you have used other `Slice` language mappings, such as C++ or Java. Using static code generation, the `Slice` compiler `slice2rb` (see Section 26.15.4) generates Ruby code from your `Slice` definitions.

Compiler Output

For each Slice file `X.ice`, `slice2rb` generates Ruby code into a file named `X.rb` in the output directory. The default output directory is the current working directory, but a different directory can be specified using the `--output-dir` option.

Include Files

It is important to understand how `slice2rb` handles include files. In the absence of the `--all` option, the compiler does not generate Ruby code for Slice definitions in included files. Rather, the compiler translates Slice `#include` statements into Ruby `require` statements in the following manner:

1. Determine the full pathname of the included file.
2. Create the shortest possible relative pathname for the included file by iterating over each of the include directories (specified using the `-I` option) and removing the leading directory from the included file if possible.

For example, if the full pathname of an included file is `/opt/App/slice/OS/Process.ice`, and we specified the options `-I/opt/App` and `-I/opt/App/slice`, then the shortest relative pathname is `OS/Process.ice` after removing `/opt/App/slice`.

3. Replace the `.ice` extension with `.rb`. Continuing our example from the previous step, the translated `require` statement becomes

```
require "OS/Process.rb"
```

As a result, you can use `-I` options to tailor the `require` statements generated by the compiler in order to avoid absolute pathnames and match the organizational structure of your application's source files.

26.15.3 Static Versus Dynamic Code Generation

There are several issues to consider when evaluating your requirements for code generation.

Application Considerations

The requirements of your application generally dictate whether you should use dynamic or static code generation. Dynamic code generation is convenient for a number of reasons:

- It avoids the intermediate compilation step required by static code generation.

- It makes the application more compact because the application requires only the Slice files, not the additional files produced by static code generation.
- It reduces complexity, which is especially helpful during testing, or when writing short or transient programs.

Static code generation, on the other hand, is appropriate in many situations:

- when an application uses a large number of Slice definitions and the startup delay must be minimized
- when it is not feasible to deploy Slice files with the application
- when a number of applications share the same Slice files
- when Ruby code is required in order to utilize third-party Ruby tools.

Mixing Static and Dynamic Generation

You can safely use a combination of static and dynamic translation in an application. For it to work properly, you must correctly manage the include paths for Slice translation and the Ruby interpreter so that the statically-generated code can be imported properly by `require`.

For example, suppose you want to dynamically load the following Slice definitions:

```
#include <Glacier2/Session.ice>

module MyApp {
  interface MySession extends Glacier2::Session {
    // ...
  };
};
```

Whether the included file `Glacier2/Session.ice` is loaded dynamically or statically is determined by the presence of the `--all` option:

```
sliceDir = "-I#{ENV['ICE_HOME']}/slice"

# Load Glacier2/Session.ice dynamically:
Ice::loadSlice(sliceDir + " --all MySession.ice")

# Load Glacier2/Session.ice statically:
Ice::loadSlice(sliceDir + " MySession.ice")
```

In this example, the first invocation of `loadSlice` uses the `--all` option so that code is generated dynamically for all included files. The second invocation

omits `--all`, therefore the Ruby interpreter executes the equivalent of the following statement:

```
require "Glacier2/Session.rb"
```

As a result, before we can call `loadSlice` we must first ensure that the interpreter can locate the statically-generated file `Glacier2/Session.rb`. We can do this in a number of ways, including

- adding the parent directory (e.g., `/opt/IceRuby/ruby`) to the **RUBYLIB** environment variable
- specifying the `-I` option when starting the interpreter
- modifying the search path at run time, as shown below:

```
$.unshift("/opt/IceRuby/ruby")
```

26.15.4 `slice2rb` Command-Line Options

The Slice-to-Ruby compiler, `slice2rb`, offers the following command-line options in addition to the standard options described in Section 4.19:

- `--all`
Generate code for all Slice definitions, including those from included files.
- `--checksum`
Generate checksums for Slice definitions.

26.16 Using Slice Checksums

As described in Section 4.20, the Slice compilers can optionally generate checksums of Slice definitions. For `slice2rb`, the `--checksum` option causes the compiler to generate code that adds checksums to the hash collection `Ice::SliceChecksums`. The checksums are installed automatically when the Ruby code is first parsed; no action is required by the application.

In order to verify a server's checksums, a client could simply compare the two hash objects using a comparison operator. However, this is not feasible if it is possible that the server might return a superset of the client's checksums. A more general solution is to iterate over the local checksums as demonstrated below:

```
serverChecksums = ...
for i in Ice::SliceChecksums.keys
  if not serverChecksums.has_key?(i)
    # No match found for type id!
  elif Ice::SliceChecksums[i] != serverChecksums[i]
    # Checksum mismatch!
  end
end
```

In this example, the client first verifies that the server's dictionary contains an entry for each Slice type ID, and then it proceeds to compare the checksums.

Chapter 27

Developing a File System Client in Ruby

27.1 Chapter Overview

In this chapter, we present the source code for a Ruby client that accesses the file system we developed in Chapter 5.

27.2 The Ruby Client

We now have seen enough of the client-side Ruby mapping to develop a complete client to access our remote file system. For reference, here is the Slice definition once more:

```
module Filesystem {
  interface Node {
    nonmutating string name();
  };

  exception GenericError {
    string reason;
  };

  sequence<string> Lines;

  interface File extends Node {
```

```

        nonmutating Lines read();
        idempotent void write(Lines text) throws GenericError;
};

sequence<Node*> NodeSeq;

interface Directory extends Node {
    nonmutating NodeSeq list();
};

interface Filesys {
    nonmutating Directory* getRoot();
};
};

```

To exercise the file system, the client does a recursive listing of the file system, starting at the root directory. For each node in the file system, the client shows the name of the node and whether that node is a file or directory. If the node is a file, the client retrieves the contents of the file and prints them.

The body of the client code looks as follows:

```

require 'Filesystem.rb'

# Recursively print the contents of directory "dir"
# in tree fashion. For files, show the contents of
# each file. The "depth" parameter is the current
# nesting level (for indentation).

def listRecursive(dir, depth)
    indent = ''
    depth = depth + 1
    for i in (0..depth)
        indent += "\t"
    end

    contents = dir.list()

    for node in contents
        subdir = Filesystem::DirectoryPrx::checkedCast(node)
        file = Filesystem::FilePrx::uncheckedCast(node)
        print indent + node.name()
        if subdir
            puts "(directory):"
            listRecursive(subdir, depth)
        else

```

```
        puts "(file):"
        text = file.read()
        for line in text
            puts indent + "\t" + line
        end
    end
end
end

status = 0
ic = nil
begin
    # Create a communicator
    #
    ic = Ice::initialize(ARGV)

    # Create a proxy for the root directory
    #
    obj = ic.stringToProxy("RootDir:default -p 10000")

    # Down-cast the proxy to a Directory proxy
    #
    rootDir = Filesystem::DirectoryPrx::checkedCast(obj)

    # Recursively list the contents of the root directory
    #
    puts "Contents of root directory:"
    listRecursive(rootDir, 0)
rescue => ex
    puts ex
    print ex.backtrace.join("\n")
    status = 1
end

if ic
    # Clean up
    #
    begin
        ic.destroy()
    rescue => ex
        puts ex
        print ex.backtrace.join("\n")
        status = 1
    end
end
```

```
        end
    end

    exit(status)
```

The program first defines the `listRecursive` function, which is a helper function to print the contents of the file system, and the main program follows. Let us look at the main program first:

1. The structure of the code follows what we saw in Chapter 3. After initializing the run time, the client creates a proxy to the root directory of the file system. For this example, we assume that the server runs on the local host and listens using the default protocol (TCP/IP) at port 10000. The object identity of the root directory is known to be `RootDir`.
2. The client down-casts the proxy to `DirectoryPrx` and passes that proxy to `listRecursive`, which prints the contents of the file system.

Most of the work happens in `listRecursive`. The function is passed a proxy to a directory to list, and an indent level. (The indent level increments with each recursive call and allows the code to print the name of each node at an indent level that corresponds to the depth of the tree at that node.) `listRecursive` calls the `list` operation on the directory and iterates over the returned sequence of nodes:

1. The code does a `checkedCast` to narrow the `Node` proxy to a `Directory` proxy, as well as an `uncheckedCast` to narrow the `Node` proxy to a `File` proxy. Exactly one of those casts will succeed, so there is no need to call `checkedCast` twice: if the `Node` *is-a* `Directory`, the code uses the `DirectoryPrx` returned by the `checkedCast`; if the `checkedCast` fails, we *know* that the `Node` *is-a* `File` and, therefore, an `uncheckedCast` is sufficient to get a `FilePrx`.

In general, if you know that a down-cast to a specific type will succeed, it is preferable to use an `uncheckedCast` instead of a `checkedCast` because an `uncheckedCast` does not incur any network traffic.

2. The code prints the name of the file or directory and then, depending on which cast succeeded, prints "`(directory)`" or "`(file)`" following the name.
3. The code checks the type of the node:
 - If it is a directory, the code recurses, incrementing the indent level.
 - If it is a file, the code calls the `read` operation on the file to retrieve the file contents and then iterates over the returned sequence of lines, printing each line.

Assume that we have a small file system consisting of a two files and a a directory as follows:

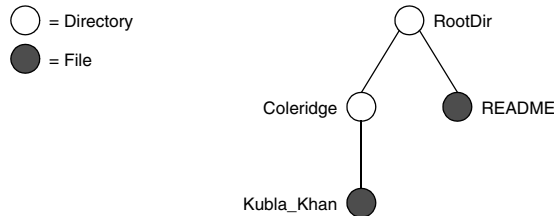

Figure 27.1. A small file system.

The output produced by client for this file system is:

Contents of root directory:

README (file):

This file system contains a collection of poetry.

Coleridge (directory):

Kubla_Khan (file):

In Xanadu did Kubla Khan
 A stately pleasure-dome decree:
 Where Alph, the sacred river, ran
 Through caverns measureless to man
 Down to a sunless sea.

Note that, so far, our client is not very sophisticated:

- The protocol and address information are hard-wired into the code.
- The client makes more remote procedure calls than strictly necessary; with minor redesign of the Slice definitions, many of these calls can be avoided.

We will see how to address these shortcomings in Chapter 37 and XREF.

27.3 Summary

This chapter presented a very simple client to access a server that implements the file system we developed in Chapter 5. As you can see, the Ruby code hardly differs from the code you would write for an ordinary Ruby program. This is one of the biggest advantages of using Ice: accessing a remote object is as easy as accessing an ordinary, local Ruby object. This allows you to put your effort where

you should, namely, into developing your application logic instead of having to struggle with arcane networking APIs.

Part III.G

PHP Mapping

Chapter 28

Ice Extension for PHP

28.1 Chapter Overview

This chapter describes IcePHP, the Ice extension for the PHP scripting language. Section 28.2 provides an overview of IcePHP, including its design goals, capabilities, and limitations. IcePHP configuration is discussed in Section 28.3, and the PHP language mapping is specified in Section 28.4.

28.2 Introduction

PHP is a general-purpose scripting language that is used primarily in Web development. The PHP interpreter is typically installed as a Web server plug-in, and PHP itself also supports plug-ins known as “extensions.” PHP extensions, by definition, extend the interpreter’s run-time environment by adding new functions and data types.

The Ice extension for PHP, *IcePHP*, provides PHP scripts with access to Ice facilities. IcePHP is a thin integration layer implemented in C++ using the Ice C++ run-time library. This implementation technique has a number of advantages over a native PHP implementation of the Ice run-time:

1. Speed

The majority of the time-consuming work involved in making remote invocations, such as marshaling and unmarshaling, is performed in compiled C++, instead of in interpreted PHP.

2. Integration

IcePHP is fully self-contained. Its installation is performed once as an administrative step, and scripts have no dependencies on external PHP code.

3. Reliability

By leveraging the well-tested Ice C++ run-time library, there is less likelihood that new bugs will be introduced into the PHP extension.

4. Flexibility

IcePHP inherits all of the flexibility provided by the Ice C++ run-time, such as support for SSL, protocol compression, etc.

28.2.1 Capabilities

IcePHP supplies a robust subset of the Ice run-time facilities. PHP scripts are able to use all of the Slice data types in a natural way (see Section 28.4), make remote invocations, and use all of the advanced Ice services such as routers, locators and protocol plug-ins.

28.2.2 Limitations

The primary design goal of IcePHP was to provide PHP scripts with a simple and efficient interface to the Ice run-time. To that end, the feature set supported by IcePHP was carefully selected to address the requirements of typical PHP applications. As a result, IcePHP does not support the following Ice features:

- Servers

Given PHP's primary role as a scripting language for dynamic Web pages, the ability to implement an Ice server in PHP was deemed unnecessary for the majority of PHP applications.

- Asynchronous method invocation

The lack of synchronization primitives in PHP greatly reduces the utility of asynchronous invocations.

- Multiple communicators

A script has access to only one instance of `Ice::Communicator`, and is not able to manually create or destroy a communicator. See Section 28.4.11 for more information.

28.2.3 Design

The traditional design for a language mapping requires the intermediate step of translating Slice definitions into the target programming language before they can be used in an application.

IcePHP takes a different approach, made possible by the flexibility of PHP's extension interfaces. In IcePHP, no intermediate code generation step is necessary. Instead, the extension is configured with the application's Slice definitions, which are used to drive the extension's run-time behavior (see Section 28.3).

The Slice definitions are made available to PHP scripts as specified by the mapping in Section 28.4, just as if the Slice definitions had first gone through the traditional code-generation step and then been imported by the script.

There are several advantages to this design:

- The development process is simplified by the elimination of the intermediate code-generation step.
- The lack of machine-generated PHP code reduces the risk that the application's type definitions become outdated.
- Although PHP is a loosely-typed programming language, the Slice definitions enable IcePHP to validate the arguments of remote invocations.

28.3 Configuration

This section describes how to configure IcePHP, including its configuration directives and the run time functions used to activate a configuration. For installation instructions, please refer to the `INSTALL` file included in the IcePHP distribution.

28.3.1 Profiles

IcePHP allows any number of PHP applications to run independently in the same PHP interpreter, without risk of conflicts caused by Slice definitions that happened to use the same identifiers. IcePHP uses the term *profile* to describe an

application's configuration, including its Slice definitions and Ice configuration properties.

28.3.2 Default Profile

A default profile is supported, which is convenient during development, or when only one Ice application is running in a PHP interpreter. Table 28.1 describes the PHP configuration directives¹ for the default profile.

Table 28.1. PHP configuration directive for the default profile.

Name	Description
<code>ice.config</code>	Specifies the pathname of an Ice configuration file.
<code>ice.options</code>	Specifies command-line options for Ice configuration properties. For example, <code>--Ice.Trace.Network=1</code> . This is a convenient alternative to an Ice configuration file if only a few configuration properties are required.
<code>ice.profiles</code>	Specifies the pathname of a profile configuration file. See Section 28.3.3.
<code>ice.slice</code>	Specifies preprocessor options and the pathnames of Slice files to be loaded.

Here is a simple example:

```
ice.options="--Ice.Trace.Network=1 --Ice.Warn.Connections=1"
ice.slice="-I/myapp/include /myapp/include/MyApp.ice"
```

28.3.3 Named Profiles

If a filename is specified by the `ice.profiles` configuration directive, the file is expected to have the standard INI-file format. The section names identify

1. These directives are typically defined in the `php.ini` file, but can also be defined using Web-server specific directives.

profiles, where each profile supports the `ice.config`, `ice.options` and `ice.slice` directives defined in Section 28.3.2. For example:

```
[Profile1]
ice.config=/profile1/ice.cfg
ice.slice=/profile1/App.ice

[Profile2]
ice.config=/profile2/ice.cfg
ice.slice=/profile2/App.ice
```

This file defines two named profiles, `Profile1` and `Profile2`, having separate Ice configurations and Slice definitions.

28.3.4 Profile Functions

Two global functions are provided for profile activities:

```
Ice_loadProfile(/* string */ $name = null);
Ice_dumpProfile();
```

The `Ice_loadProfile` function must be invoked by a script in order to make the Slice types available and to configure the script's communicator. If no profile name is supplied, the default profile is loaded. A script is not allowed to load more than one profile.

For example, here is a script that loads `Profile1` shown in Section 28.3.3:

```
<?php
Ice_loadProfile("Profile1");
...
?>
```

For troubleshooting purposes, the `Ice_dumpProfile` function can be called by a script. This function displays all of the relevant information about the profile loaded by the script, including the communicator's configuration properties as well as the PHP mappings for all of the Slice definitions loaded by the profile.

28.3.5 Slice Semantics

The expense of parsing Slice files is incurred once, when the PHP interpreter initializes the IcePHP extension. For this reason, we recommend that the IcePHP extension be statically configured into the PHP interpreter, either by compiling the extension directly into the interpreter, or configuring PHP to load the extension dynamically at startup. For the same reason, we discourage the use of IcePHP in a

CGI context, in which a new PHP interpreter is created for every HTTP request. Furthermore, we strongly discourage scripts from dynamically loading the IcePHP extension using PHP's `dlopen` function.

28.3.6 Using IceSSL

An IcePHP application can establish an SSL connection to an Ice server if it is properly configured to use the IceSSL plug-in. Since IcePHP uses the Ice for C++ run time, you should consult the C++ sections of Chapter 40 for detailed instructions on installing and configuring IceSSL.

A typical IceSSL configuration uses several properties, therefore it is often more convenient to define an external configuration file via the `ice.config` directive:

```
ice.config=/opt/MyApp/ice.cfg
```

The file `ice.cfg` might contain the configuration properties shown below:

```
Ice.Plugin.IceSSL=IceSSL:createIceSSL
IceSSL.DefaultDir=/opt/MyApp/certs
IceSSL.CertAuthFile=ca.pem
IceSSL.CertFile=client.pem
IceSSL.KeyFile=key.pem
...
```

An IcePHP application can only use the IceSSL features that are available via configuration properties; the plug-in's programmatic interface is not currently supported in PHP.

As a final note, you should carefully consider the security implications of using SSL given that all of the scripts executed by the same instance of a PHP interpreter share the same communicator and therefore the same IceSSL configuration.

28.4 Client-Side Slice-to-PHP Mapping

This section describes the PHP mapping for Slice types.

28.4.1 Mapping for Identifiers

Slice identifiers map to PHP identifiers of the same name, unless the Slice identifier conflicts with a PHP reserved word, in which case the mapped identifier is

prefixed with an underscore. For example, the Slice identifier `echo` is mapped as `_echo`.

A flattened mapping is used for identifiers defined within Slice modules because PHP does not have an equivalent to C++ namespaces or Java packages. The flattened mapping uses underscores to separate the components of a fully-scoped name. For example, consider the following Slice definition:

```
module M {  
    enum E { one, two, three };  
};
```

In this case, the Slice identifier `M::E` is flattened to the PHP identifier `M_E`.

Note that when checking for a conflict with a PHP reserved word, only the fully-scoped, flattened identifier is considered. For example, the Slice identifier `M::function` is mapped as `M_function`, despite the fact that `function` is a PHP reserved word. There is no need to map it as `M__function` (with two underscores) because `M_function` does not conflict with a PHP reserved word.

However, it is still possible for the flattened mapping to generate identifiers that conflict with PHP reserved words. For instance, the Slice identifier `require::once` must be mapped as `_require_once` in order to avoid conflict with the PHP reserved word `require_once`.

28.4.2 Mapping for Simple Built-in Types

PHP has a limited set of primitive types: `boolean`, `integer`, `double`, and `string`. The Slice built-in types are mapped to PHP types as shown in Table 28.2.

Table 28.2. Mapping of Slice built-in types to PHP.

Slice	PHP
<code>bool</code>	<code>boolean</code>
<code>byte</code>	<code>integer</code>
<code>short</code>	<code>integer</code>
<code>int</code>	<code>integer</code>

Table 28.2. Mapping of Slice built-in types to PHP.

Slice	PHP
long	integer
float	double
double	double
string	string

PHP's `integer` type may not accommodate the range of values supported by Slice's `long` type, therefore `long` values that are outside this range are mapped as strings. Scripts must be prepared to receive an integer or string from any operation that returns a `long` value.

28.4.3 Mapping for User-Defined Types

Slice supports user-defined types: enumerations, structures, sequences, and dictionaries.

Mapping for Enumerations

Enumerations map to a PHP class containing a constant definition for each enumerator. For example:

```
enum Fruit { Apple, Pear, Orange };
```

The PHP mapping is shown below:

```
class Fruit {  
    const Apple = 0;  
    const Pear = 1;  
    const Orange = 2;  
}
```

The enumerators can be accessed in PHP code as `Fruit::Apple`, etc.

Mapping for Structures

Slice structures map to PHP classes. For each Slice data member, the PHP class contains a variable of the same name. For example, here is our `Employee` structure from Section 4.9.4 yet again:

```
struct Employee {
    long number;
    string firstName;
    string lastName;
};
```

This structure is mapped to the following PHP class:

```
class Employee {
    var $number;
    var $firstName;
    var $lastName;
}
```

Mapping for Sequences

Slice sequences are mapped to native PHP indexed arrays. The first element of the Slice sequence is contained at index 0 (zero) of the PHP array, followed by the remaining elements in ascending index order.

Here is the definition of our `FruitPlatter` sequence from Section 4.9.3:

```
sequence<Fruit> FruitPlatter;
```

You can create an instance of this sequence as shown below:

```
// Make a small platter with one Apple and one Orange
//
$platter = array(Fruit::Apple, Fruit::Orange);
```

Mapping for Dictionaries

Slice dictionaries map to native PHP associative arrays. The PHP mapping does not currently support all Slice dictionary types, however, because native PHP associative arrays support only integer and string key types. A Slice dictionary whose key type is `boolean`, `byte`, `short`, `int` or `long` is mapped as an associative array with an integer key.² A Slice dictionary with a string key type is mapped as

2. Boolean values are treated as integers, with false equivalent to 0 (zero) and true equivalent to 1 (one).

associative array with a string key. All other key types cause a warning to be generated.

Here is the definition of our `EmployeeMap` from Section 4.9.4:

```
dictionary<long, Employee> EmployeeMap;
```

You can create an instance of this dictionary as shown below:

```
$e1 = new Employee;
$e1->number = 42;
$e1->firstName = "Stan";
$e1->lastName = "Lipmann";

$e2 = new Employee;
$e2->number = 77;
$e2->firstName = "Herb";
$e2->lastName = "Sutter";

$em = array($e1->number => $e1, $e2->number => $e2);
```

28.4.4 Mapping for Constants

Slice constant definitions map to corresponding calls to the PHP function `define`. Here are the constant definitions we saw in Section 4.9.5:

```
const bool      AppendByDefault = true;
const byte      LowerNibble = 0x0f;
const string    Advice = "Don't Panic!";
const short     TheAnswer = 42;
const double    PI = 3.1416;
```

```
enum Fruit { Apple, Pear, Orange };
const Fruit FavoriteFruit = Pear;
```

Here are the equivalent PHP definitions for these constants:

```
define("AppendByDefault", true);
define("LowerNibble", 15);
define("Advice", "Don't Panic!");
define("TheAnswer", 42);
define("PI", 3.1416);

class Fruit {
    const Apple = 0;
```

```

    const Pear = 1;
    const Orange = 2;
}
define("FavoriteFruit", Fruit::Pear);

```

28.4.5 Mapping for Exceptions

A Slice exception maps to a PHP class. For each exception member, the corresponding class contains a variable of the same name. All user exceptions ultimately derive from `Ice_UserException` (which, in turn, derives from `Ice_Exception`, which derives from PHP's base `Exception` class):

```

abstract class Ice_Exception extends Exception {
    function __construct($message = '') {
        ...
    }
}

abstract class Ice_UserException extends Ice_Exception {
    function __construct($message = '') {
        ...
    }
}

```

The optional string argument to the constructor is passed unmodified to the `Exception` constructor.

If the exception derives from a base exception, the corresponding PHP class derives from the mapped class for the base exception. Otherwise, if no base exception is specified, the corresponding class derives from `Ice_UserException`.

Here is a fragment of the Slice definition for our world time server from Section 4.10.5:

```

exception GenericError {
    string reason;
};
exception BadTimeVal extends GenericError {};
exception BadZoneName extends GenericError {};

```

These exceptions are mapped as the following PHP classes:

```

class GenericError extends Ice_UserException {
    function __construct($message = '') {
        ...
    }
}

```

```

        var $reason;
    }

    class BadTimeVal extends GenericError {
        function __construct($message = '') {
            ...
        }
    }

    class BadZoneName extends GenericError {
        function __construct($message = '') {
            ...
        }
    }

```

An application can catch these exceptions as shown below:

```

try {
    ...
} catch(BadZoneName $ex) {
    // Handle BadZoneName
} catch(GenericError $ex) {
    // Handle GenericError
} catch(Ice_Exception $ex) {
    // Handle all other Ice exceptions
    print_r($ex);
}

```

28.4.6 Mapping for Run-Time Exceptions

The Ice run time throws run-time exceptions for a number of pre-defined error conditions. All run-time exceptions directly or indirectly derive from `Ice_LocalException` (which, in turn, derives from `Ice_Exception`, which derives from PHP's base `Exception` class):

```

abstract class Ice_Exception extends Exception {
    function __construct($message = '') {
        ...
    }
}

abstract class Ice_LocalException extends Ice_Exception {
    function __construct($message = '') {
        ...
    }
}

```

An inheritance diagram for user and run-time exceptions appears in Figure 4.4 on page 110. Note however that the PHP mapping only defines classes for the local exceptions listed below:

- `Ice_LocalException`
- `Ice_UnknownException`
- `Ice_UnknownLocalException`
- `Ice_UnknownUserException`
- `Ice_RequestFailedException`
- `Ice_ObjectNotExistException`
- `Ice_FacetNotExistException`
- `Ice_OperationNotExistException`
- `Ice_ProtocolException`
- `Ice_MarshalException`
- `Ice_NoObjectFactoryException`
- `Ice_UnexpectedObjectException`

Instances of all remaining local exceptions are converted to the class `Ice_UnknownLocalException`. The `unknown` member of this class contains a string representation of the original exception.

28.4.7 Mapping for Interfaces

A Slice interface maps to a PHP interface. Each operation in the interface maps to a method of the same name, as described in Section 28.4.9. The inheritance structure of the Slice interface is preserved in the PHP mapping, and all interfaces ultimately derive from `Ice_Object`:

```
interface Ice_Object {};
```

For example, consider the following Slice definitions:

```
interface A {
    void opA();
};
interface B extends A {
    void opB();
};
```

These interfaces are mapped to PHP interfaces as shown below:

```

interface A implements Ice_Object
{
    function opA();
}
interface B implements A
{
    function opB();
}

```

28.4.8 Mapping for Classes

A Slice class maps to an abstract PHP class. Each operation in the class maps to an abstract method of the same name, as described in Section 28.4.9. For each Slice data member, the PHP class contains a variable of the same name. The inheritance structure of the Slice class is preserved in the PHP mapping, and all classes ultimately derive from `Ice_ObjectImpl` (which, in turn, implements `Ice_Object`):

```

class Ice_ObjectImpl implements Ice_Object
{
}

```

Consider the following class definition:

```

class TimeOfDay {
    short hour;           // 0 - 23
    short minute;        // 0 - 59
    short second;        // 0 - 59
    string format();     // Return time as hh:mm:ss
};

```

The PHP mapping for this class is shown below:

```

abstract class TimeOfDay extends Ice_ObjectImpl
{
    var $hour;
    var $minute;
    var $second;
    abstract function format();
}

```

Class Factories

Class factories are installed by invoking `addObjectFactory` on the communicator (see Section 28.4.11). A factory must implement the interface `Ice_ObjectFactory`, defined as follows:

```
interface Ice_ObjectFactory implements Ice_LocalObject
{
    function create(/* string */ $id);
    function destroy();
}
```

For example, we can define and install a factory for the TimeOfDay class as shown below:

```
class TimeOfDayI extends TimeOfDay {
    function format()
    {
        return sprintf("%02d:%02d:%02d", $this->hour,
            $this->minute, $this->second);
    }
}

class TimeOfDayFactory extends Ice_LocalObjectImpl
    implements Ice_ObjectFactory {
    function create($id)
    {
        return new TimeOfDayI;
    }

    function destroy() {}
}

$ICE->addObjectFactory(new TimeOfDayFactory, "::M::TimeOfDay");
```

28.4.9 Mapping for Operations

Each operation defined in a Slice class or interface is mapped to a PHP function of the same name. Furthermore, each parameter of an operation is mapped to a PHP parameter of the same name, with out parameters passed by reference. Since PHP is a loosely-typed language, no parameter types are specified.³

Consider the following interface:

3. PHP5 introduces the notion of “type hints” that allow you to specify the formal type of object parameters. This would enable the Slice mapping to specify type hints for parameters of type struct, interface, class and proxy. Unfortunately, PHP5 does not currently allow a parameter defined with a type hint to receive a null value, therefore the Slice mapping does not use type hints for parameters.

```
interface I {
    float op(string s, out int i);
};
```

The PHP mapping for this interface is shown below:

```
interface I {
    function op($s, &$i);
}
```

28.4.10 Mapping for Proxies

The PHP mapping for Slice proxies uses a single interface, `Ice_ObjectPrx`, to represent all proxy types.

Typed Versus Untyped Proxies

A proxy can be typed or untyped. All proxies, whether they are typed or untyped, support the core proxy methods described in the next section.

An *untyped proxy* is equivalent to the Slice type `Object*`. The communicator operation `stringToProxy` returns an untyped proxy, as do several of the core proxy methods. A script cannot invoke user-defined operations on an untyped proxy, nor can an untyped proxy be passed as an argument where a typed proxy is expected.

A *typed proxy* is one that has been associated with a Slice class or interface type. There are two ways a script can obtain a typed proxy:

1. By receiving it as the result of a remote invocation that returns a typed proxy.
2. By using the core proxy methods `ice_checkedCast` or `ice_uncheckedCast`.

For example, suppose our script needs to obtain a typed proxy for interface A, shown below:

```
interface A {
    void opA();
};
```

Here are the steps our script performs:

```
$obj = $ICE->stringToProxy("a:tcp -p 12345");
$obj->opA(); // WRONG!
$a = $obj->ice_checkedCast("::A");
$a->opA(); // OK
```

Attempting to invoke `opA` on `$obj` would result in a fatal error, because `$obj` is an untyped proxy.

Core Proxy Methods

The `Ice_ObjectPrx` interface supplies the standard proxy methods described in Section 31.10.1, as well as two additional methods for downcasting purposes:

```
interface Ice_ObjectPrx {
    /* ... standard proxy methods ... */
    function ice_uncheckedCast(/* string */ $type,
                              /* string */ $facet = null);
    function ice_checkedCast(/* string */ $type,
                             /* string */ $facet = null);
}
```

To demonstrate the use of proxy factory methods, consider this example:

```
$p = $ICE->stringToProxy("a:tcp -p 12345");
$p = $p->ice_oneway();
$p = $p->ice_secure(true);
$p = $p->ice_uncheckedCast("::A");
```

The script receives an untyped proxy as the return value of `stringToProxy`. Since the stringified proxy did not contain any proxy options, it is configured by default as a twoway, insecure proxy with no timeout. However, our goal is to obtain a secure oneway proxy for interface A, therefore we invoke `ice_oneway`, followed by `ice_secure`. At this point, we have an untyped proxy configured for secure oneway invocations. Finally, we call `ice_uncheckedCast` to obtain a typed proxy.⁴

Note that this process can be simplified by chaining the proxy factory methods, as shown below:

```
$p = $ICE->stringToProxy("a:tcp -p 12345");
$p = $p->ice_oneway()->ice_secure(true)->ice_uncheckedCast("::A");
```

The order that the proxy factory methods are invoked is usually not important, except in the case of `ice_checkedCast` and `ice_uncheckedCast`. For example, if the script above had invoked `ice_uncheckedCast` first, followed by the other factory methods, then the result would have been an untyped proxy:

4. We cannot use `ice_checkedCast` on a proxy configured for oneway invocations.

```

$p = $ICE->stringToProxy("a:tcp -p 12345");
$p = $p->ice_uncheckedCast("::A"); // WRONG!
$p = $p->ice_oneway();
$p = $p->ice_secure(true);

```

The reason for this unexpected behavior is that most of the factory methods return an untyped proxy, thereby discarding any type that might have been associated with the original proxy. By invoking `ice_oneway` on the typed proxy returned from `ice_uncheckedCast`, the script has lost its typed proxy.

Request Context

All remote operations on a proxy support an optional final parameter of type `Ice::Context` representing the request context. The standard PHP mapping for the request context is an associative array in which the keys and values are strings. For example, the code below illustrates how to invoke `ice_ping` with a request context:

```

$p = $ICE->stringToProxy("a:tcp -p 12345");
$ctx = array("theKey" => "theValue");
$p->ice_ping($ctx);

```

Alternatively, a script can specify a default request context using the proxy method `ice_newContext`. See Section 31.11 for more information on request contexts.

Identity

Certain core proxy operations use the type `Ice_Identity`, which is the PHP mapping for the Slice type `Ice::Identity` (see Section 31.5). This type is mapped using the standard rules for Slice structures, therefore it is defined as follows:

```

class Ice_Identity {
    var $name;
    var $category;
}

```

Two communicator functions are provided for converting `Ice_Identity` values to and from a string representation. See Section 28.4.11 for details.

28.4.11 Mapping for `Ice::Communicator`

Since the Ice extension for PHP provides only client-side facilities, many of the operations provided by `Ice::Communicator` operations are not relevant, therefore

the PHP mapping supports a subset of the communicator operations. The mapping for `Ice::Communicator` is shown below:

```
interface Ice_Communicator {
    function getProperty(/* string */ $name,
                        /* string */ $def = "");
    function stringToProxy(/* string */ $str);
    function proxyToString(/* Ice_ObjectPrx */ $prx);
    function stringToIdentity(/* string */ $str);
    function identityToString(/* Ice_Identity */ $id);
    function addObjectFactory(/* Ice_ObjectFactory */ $factory,
                              /* string */ $id);
    function findObjectFactory(/* string */ $id);
    function flushBatchRequests();
}
```

The `getProperty` method returns the value of a configuration property. If the property is not defined, the method returns the default value if one was provided, otherwise the method returns an empty string.

See Section 31.10.1 for a description of the remaining operations.

Communicator Lifecycle

PHP scripts are not allowed to create or destroy communicators. Rather, a communicator is created prior to each PHP request, and is destroyed after the request completes.

Accessing the Communicator

The communicator instance created for a request is available to the script via the global variable `$ICE`. Scripts should not attempt to assign a different value to this variable. As with any global variable, scripts that need to use `$ICE` from within a function must declare the variable as global:

```
function printProxy($prx) {
    global $ICE;

    print $ICE->proxyToString($prx);
}
```

Communicator Configuration

The profile loaded by the script determines the communicator's configuration. See Section 28.3 for more information.

Chapter 29

Developing a File System Client in PHP

29.1 Chapter Overview

In this chapter, we present the source code for a PHP client that accesses the file system we developed in Chapter 5. This client can interact with a server written in any of the other language mappings.

29.2 The PHP Client

We now have seen enough of the PHP mapping to develop a complete client to access our remote file system. For reference, here is the Slice definition once more:

```
module Filesystem {
    interface Node {
        nonmutating string name();
    };

    exception GenericError {
        string reason;
    };

    sequence<string> Lines;
```

```

interface File extends Node {
    nonmutating Lines read();
    idempotent void write(Lines text) throws GenericError;
};

sequence<Node*> NodeSeq;

interface Directory extends Node {
    nonmutating NodeSeq list();
};

interface Filesys {
    nonmutating Directory* getRoot();
};
};

```

To exercise the file system, the client does a recursive listing of the file system, starting at the root directory. For each node in the file system, the client shows the name of the node and whether that node is a file or directory. If the node is a file, the client retrieves the contents of the file and prints them.

The body of the client code looks as follows:

```

<?php
Ice_loadProfile();

// Recursively print the contents of directory "dir"
// in tree fashion. For files, show the contents of
// each file. The "depth" parameter is the current
// nesting level (for indentation).

function listRecursive($dir, $depth = 0)
{
    $indent = str_repeat("\t", ++$depth);

    $contents = $dir->_list(); // list is a reserved word in PHP

    foreach ($contents as $i) {
        $dir = $i->ice_checkedCast("::Filesystem::Directory");
        $file = $i->ice_uncheckedCast("::Filesystem::File");
        echo $indent . $i->name() .
            ($dir ? " (directory):" : " (file):") . "\n";
        if ($dir) {
            listRecursive($dir, $depth);
        } else {
            $text = $file->read();

```

```
        foreach ($text as $j)
            echo $indent . "\t" . $j . "\n";
    }
}

try
{
    // Create a proxy for the root directory
    //
    $base = $ICE->stringToProxy("RootDir:default -p 10000");

    // Down-cast the proxy to a Directory proxy
    //
    $rootDir = $base->ice_checkedCast("::Filesystem::Directory");

    // Recursively list the contents of the root directory
    //
    echo "Contents of root directory:\n";
    listRecursive($rootDir);
}
catch(Ice_LocalException $ex)
{
    print_r($ex);
}
?>
```

The program first defines the `listRecursive` function, which is a helper function to print the contents of the file system, and the main program follows. Let us look at the main program first:

1. The client first creates a proxy to the root directory of the file system. For this example, we assume that the server runs on the local host and listens using the default protocol (TCP/IP) at port 10000. The object identity of the root directory is known to be `RootDir`.
2. The client down-casts the proxy to the `Directory` interface and passes that proxy to `listRecursive`, which prints the contents of the file system.

Most of the work happens in `listRecursive`. The function is passed a proxy to a directory to list, and an indent level. (The indent level increments with each recursive call and allows the code to print the name of each node at an indent level that corresponds to the depth of the tree at that node.) `listRecursive` calls the `list` operation on the directory and iterates over the returned sequence of nodes:

1. The code uses `ice_checkedCast` to narrow the Node proxy to a Directory proxy, and uses `ice_uncheckedCast` to narrow the Node proxy to a File proxy. Exactly one of those casts will succeed, so there is no need to call `ice_checkedCast` twice: if the Node *is-a* Directory, the code uses the proxy returned by `ice_checkedCast`; if `ice_checkedCast` fails, we *know* that the Node *is-a* File and, therefore, `ice_uncheckedCast` is sufficient to get a File proxy.

In general, if you know that a down-cast to a specific type will succeed, it is preferable to use `ice_uncheckedCast` instead of `ice_checkedCast` because `ice_uncheckedCast` does not incur any network traffic.

2. The code prints the name of the file or directory and then, depending on which cast succeeded, prints " (directory) " or " (file) " following the name.
3. The code checks the type of the node:
 - If it is a directory, the code recurses, incrementing the indent level.
 - If it is a file, the code calls the read operation on the file to retrieve the file contents and then iterates over the returned sequence of lines, printing each line.

Assume that we have a small file system consisting of a two files and a a directory as follows:

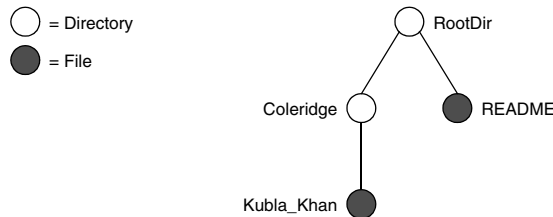

Figure 29.1. A small file system.

The output produced by client for this file system is:

```

Contents of root directory:
  README (file):
    This file system contains a collection of poetry.
  Coleridge (directory):
    Kubla_Khan (file):
      In Xanadu did Kubla Khan
  
```

```
A stately pleasure-dome decree:  
Where Alph, the sacred river, ran  
Through caverns measureless to man  
Down to a sunless sea.
```

Note that, so far, our client is not very sophisticated:

- The protocol and address information are hard-wired into the code.
- The client makes more remote procedure calls than strictly necessary; with minor redesign of the Slice definitions, many of these calls can be avoided.

We will see how to address these shortcomings in Chapter 37 and XREF.

29.3 Summary

This chapter presented a very simple client to access a server that implements the file system we developed in Chapter 5. As you can see, the PHP code hardly differs from the code you would write for an ordinary PHP program. This is one of the biggest advantages of using Ice: accessing a remote object is as easy as accessing an ordinary, local PHP object. This allows you to put your effort where you should, namely, into developing your application logic instead of having to struggle with arcane networking APIs.

Part IV

Advanced Ice

Chapter 30

Ice Properties and Configuration

30.1 Chapter Overview

Ice uses a configuration mechanism that allows you to control many aspects of the behavior of your Ice applications at run time, such as maximum message size, number of threads, or whether to produce network trace messages. The configuration mechanism is not only useful to configure Ice, but you can also use it to provide configuration parameters to your own applications. The configuration mechanism is simple to use with a minimal API, yet flexible enough to cope with the needs of most applications.

Sections 30.2 to 30.7 describe the basics of the configuration mechanism and explain how to configure Ice via configuration files and command line options. Section 30.8 shows how you can create your own application-specific properties and how to access their values from within a program.

30.2 Properties

Ice and its various subsystems are configured by *properties*. A property is a name-value pair, for example:

```
Ice.UDP.SndSize=65535
```

In this example, the *property name* is `Ice.UDP.SndSize`, and the *property value* is `65535`.

You can find a complete list of the properties used to configure Ice in Appendix C.

30.2.1 Property Categories

By convention, Ice properties use the following naming scheme:

```
<application>.<category>[.<sub-category>]
```

Note that the sub-category is optional and not used by all Ice properties.

This two- or three-part naming scheme is by convention only—if you use properties to configure your own applications, you can use property names with any number of categories.

30.2.2 Reserved Prefixes

Ice reserves properties with the prefixes `Ice`, `IceBox`, `IceGrid`, `IcePatch2`, `IceSSL`, `IceStorm`, `Freeze`, and `Glacier2`. You cannot use a property beginning with one of these prefixes to configure your own application.

30.2.3 Property Syntax

A property name consists of any number of non-white space characters, excluding the `#` and `=` characters. For example, the following are valid property names:

```
foo
Foo
foo.bar
.
```

Note that there is no special significance to a period in a property name. (Periods are used to make property names more readable and are not treated specially by the property parser.)

The following are invalid property names:

```
foo bar    Illegal white space
foo=bar    Illegal =
foo#bar    Illegal #
```

30.2.4 Value Syntax

A property value consists of any number of characters. Leading and trailing white space characters are ignored. Property values cannot contain a # character. The following are legal property values:

```
65535
yes
This is a = property value.
../../config
```

The following property value is illegal:

```
foo # bar    Property values cannot contain a # character
```

30.3 Configuration Files

Properties are usually set in a configuration file. A configuration file contains a number of name–value pairs, with each pair on a separate line. Empty lines and lines consisting entirely of white space characters are ignored. The # character introduces a comment that extends to the end of the current line.

Here is a simple configuration file:

```
# Example config file for Ice

Ice.MessageSizeMax = 2048    # Largest message size is 2MB
Ice.Trace.Network=3         # Highest level of tracing for network
Ice.Trace.Protocol=         # Disable protocol tracing
```

If you set the same property more than once, the last setting prevails and overrides any previous setting. Note that assigning nothing to a property clears that property (that is, sets it to the empty string).

A property that contains the empty string (such as `Ice.Trace.Protocol` in the preceding example) is indistinguishable from a property that is not mentioned at all. This is because the API to retrieve the property value returns the empty string for non-existent properties (see page 728).

For C++, Python, Ruby and .NET, Ice reads the contents of a configuration file when you create a communicator. By default, the name of the configuration file is determined by reading the contents of the **ICE_CONFIG** environment variable.¹ You can set this variable to a relative or absolute pathname of the configuration file, for example:

```
$ ICE_CONFIG=/opt/Ice/default_config
$ export ICE_CONFIG
$ ./server
```

This causes the server to read its property settings from the configuration file in `/opt/Ice/default_config`.

Property values can include characters from non-English alphabets. The Ice run time expects the configuration file to use UTF-8 encoding for such characters. (With C++, you can specify a string converter when you read the file. See page 730, Section 31.3, and Section 31.21.)

30.4 Setting Properties on the Command Line

In addition to setting properties in a configuration file, you can also set properties on the command line, for example:

```
$ ./server --Ice.UDP.SndSize=65535 --IceSSL.Trace.Security=2
```

Any command line option that begins with `--` and is followed by one of the reserved prefixes (see page 720) is read and converted to a property setting when you create a communicator. Property settings on the command line override settings in a configuration file. If you set the same property more than once on the same command line, the last setting overrides any previous ones.

For convenience, any property not explicitly set to a value is set to the value 1. For example,

```
$ ./server --Ice.Trace.Protocol
```

is equivalent to

```
$ ./server --Ice.Trace.Protocol=1
```

Note that this feature only applies to properties that are set on the command line, but not to properties that are set from a configuration file.

You can also clear a property from the command line as follows:

```
$ ./server --Ice.Trace.Protocol=
```

1. The environment variable is not read by the Java run time; with Java, you must use the `--Ice.Config` property to set the name of the configuration file (see Section 30.5).

As for properties set from a configuration file, assigning nothing to a property clears that property.

30.5 The Ice.Config Property

The Ice.Config property has special meaning to the Ice run time: it determines the pathname of a configuration file from which to read property settings. For example:

```
$ ./server --Ice.Config=/usr/local/filesystem/config
```

This causes property settings to be read from the configuration file in /usr/local/filesystem/config.

For C++, Python, Ruby, and .NET, the `--Ice.Config` command-line option overrides any setting of the `ICE_CONFIG` environment variable, that is, if the `ICE_CONFIG` environment variable is set and you also use the `--Ice.Config` command-line option, the configuration file specified by the `ICE_CONFIG` environment variable is ignored.

If you use the `--Ice.Config` command-line option together with settings for other properties, the settings on the command line override the settings in the configuration file. For example:

```
$ ./server --Ice.Config=/usr/local/filesystem/config \  
> --Ice.MessageSizeMax=4096
```

This sets the value of the Ice.MessageSizeMax property to 4096 regardless of any setting of this property in /usr/local/filesystem/config. The placement of the `--Ice.Config` option on the command line has no influence on this precedence. For example, the following command is equivalent to the preceding one:

```
$ ./server --Ice.MessageSizeMax=4096 \  
> --Ice.Config=/usr/local/filesystem/config
```

Settings of the Ice.Config property inside a configuration file are ignored, that is, you can set Ice.Config only on the command line.

If you use the `--Ice.Config` option more than once, only the last setting of the option is used and the preceding ones are ignored. For example:

```
$ ./server --Ice.Config=file1 --Ice.Config=file2
```

This is equivalent to using:

```
$ ./server --Ice.Config=file2
```

You can use multiple configuration files by specifying a list of configuration file names, separated by commas. For example:

```
$ ./server --Ice.Config=/usr/local/filesystem/config,./config
```

This causes property settings to be retrieved from `/usr/local/filesystem/config`, followed by any settings in the file `config` in the current directory; settings in `./config` override settings `/usr/local/filesystem/config`. For C++, Python, Ruby, and .NET, this mechanism also works for configuration files specified via the `ICE_CONFIG` environment variable.

30.6 Command-Line Parsing and Initialization

When you initialize the Ice run time by calling `Ice::initialize` (C++/Ruby), `Ice.Util.initialize` (Java/C#/Visual Basic) or `Ice.initialize` (Python), you can pass an argument vector to the initialization call.²

For C++, `Ice::initialize` accepts a C++ *reference* to `argc`:

```
namespace Ice {
    CommunicatorPtr initialize(int& argc, char* argv[]);
}
```

`Ice::initialize` parses the argument vector and initializes its property settings accordingly. In addition, it removes any arguments from `argv` that are property settings. For example, assume we invoke a server as:

```
$ ./server --myoption --Ice.Config=config -x a \
--Ice.Trace.Network=3 -y opt file
```

Initially, `argc` has the value 9, and `argv` has ten elements: the first nine elements contain the program name and the arguments, and the final element, `argv[argc]`, contains a null pointer (as required by the ISO C++ standard).

2. See also Section 31.3.

When `Ice::initialize` returns, `argc` has the value 7 and `argv` contains the following elements:

```
./server
--myoption
-x
a
-y
opt
file
0          # Terminating null pointer
```

This means that you should initialize the Ice run time before you parse the command line for your application-specific arguments. That way, the Ice-related options are stripped from the argument vector for you so you do not need to explicitly skip them. If you use the `Ice::Application` helper class (see Section 8.3.1), the `run` member function is passed the cleaned-up argument vector as well.

For Java, `Ice.Util.initialize` is overloaded. The signatures are:

```
package Ice;
public final class Util {

    public static Communicator
        initialize();

    public static Communicator
        initialize(String[] args);

    public static Communicator
        initialize(StringSeqHolder args);

    public static Communicator
        initialize(InitializationData id);

    public static Communicator
        initialize(String[] args, InitializationData id);

    public static Communicator
        initialize(StringSeqHolder args, InitializationData id);

    // ...
}
```

The versions that accept an argument vector of type `String []` do not strip Ice-related options for you, so, if you use one of these methods, your code must ignore options that start with one of the reserved prefixes (`--Ice`, `--IceBox`, `--IceGrid`, `--IcePatch2`, `--IceSSL`, `--IceStorm`, `--Freeze`, and `--Glacier2`). The versions that accept a `StringSeqHolder` behave like the C++ version and strip the Ice-related options from the passed argument vector.

In C# and Visual Basic .NET, the argument vector is passed by reference to the `initialize` method, allowing it to strip the Ice-related options:

```
namespace Ice {  
  
    public sealed class Util {  
  
        public static Communicator  
            initialize();  
  
        public static Communicator  
            initialize(ref string[] args);  
  
        public static Communicator  
            initialize(InitializationData id);  
  
        public static Communicator  
            initialize(ref string[] args, InitializationData id);  
  
        // ...  
  
    }  
}
```

The Python and Ruby implementations of `initialize` have the same semantics as C++ and .NET; they expect the argument vector to be passed as a list from which all Ice-related options are removed.

If you use the `Ice.Application` helper class, the `run` method is passed the cleaned-up argument vector. The `Ice.Application` class is described in the server-side language mapping chapters.

30.7 The `Ice.ProgramName` property

For C++, Python, and Ruby, `initialize` sets the `Ice.ProgramName` property to the name of the current program (`argv[0]`). In C# and Visual Basic

.NET, `initialize` sets `Ice.ProgramName` to the value of `System.AppDomain.CurrentDomain.FriendlyName`.

Ice uses the program name for log messages. Your application code can read this property and use it for similar purposes, for example, in diagnostic or trace messages. (See Section 30.8.1 for how to access the property value in your program.)

Even though `Ice.ProgramName` is initialized for you, you can still override its value from a configuration file or by setting the property on the command line.

For Java, the program name is not supplied as part of the argument vector—if you want the program name to appear in Ice log messages, you must set `Ice.ProgramName` before initializing a Java communicator.

30.8 Using Properties Programmatically

The Ice property mechanism is useful not only to configure Ice, but you can also use it as the configuration mechanism for your own applications. You can use the same configuration file and command-line mechanism to set application-specific properties. For example, we could introduce a property to control the maximum file size for our file system application:

```
# Configuration file for file system application

Filesystem.MaxFileSize=1024    # Max file size in kB
```

The Ice run time stores the `Filesystem.MaxFileSize` property like any other property and makes it accessible via the `Properties` interface.

To access property values from within your program, you need to acquire the communicator's properties by calling `getProperties`:

```
module Ice {

    local interface Properties; // Forward declaration

    local interface Communicator {

        Properties getProperties();

        // ...
    };
};
```

The Properties interface provides methods to read and write property settings:

```
module Ice {
    local dictionary<string, string> PropertyDict;

    local interface Properties {

        string getProperty(string key);
        string getPropertyWithDefault(string key, string value);
        int getPropertyAsInt(string key);
        int getPropertyAsIntWithDefault(string key, int value);
        PropertyDict getPropertiesForPrefix(string prefix);

        void setProperty(string key, string value);

        StringSeq getCommandLineOptions();
        StringSeq parseCommandLineOptions(string prefix,
                                         StringSeq options);
        StringSeq parseIceCommandLineOptions(StringSeq options);

        void load(string file);

        Properties clone();
    };
};
```

30.8.1 Reading Properties

The operations to read property values behave as follows:

- `getProperty`
This operation returns the value of the specified property. If the property is not set, the operation returns the empty string.
- `getPropertyWithDefault`
This operation returns the value of the specified property. If the property is not set, the operation returns the supplied default value.
- `getPropertyAsInt`
This operation returns the value of the specified property as an integer. If the property is not set or contains a string that does not parse as an integer, the operation returns zero.

- `getPropertyAsIntWithDefault`

This operation returns the value of the specified property as an integer. If the property is not set or contains a string that does not parse as an integer, the operation returns the supplied default value.

- `getPropertiesForPrefix`

This operation returns all properties that begin with the specified prefix as a dictionary of type `PropertyDict`. This operation is useful if you want to extract the properties for a specific subsystem. For example,

```
getPropertiesForPrefix("Filesystem")
```

returns all properties that start with the prefix `Filesystem`, such as `Filesystem.MaxFileSize`. You can then use the usual dictionary lookup operations to extract the properties of interest from the returned dictionary.

With these lookup operations, using application-specific properties now becomes the simple matter of initializing a communicator as usual, getting access to the communicator's properties, and examining the desired property value. For example (in C++):

```
// ...

Ice::CommunicatorPtr ic;

// ...

ic = Ice::initialize(argc, argv);

// Get the maximum file size.
//
Ice::PropertiesPtr props = ic->getProperties();
Ice::Int maxSize
    = props->getPropertyAsIntWithDefault("Filesystem.MaxFileSize",
                                        1024);

// ...
```

Assuming that you have created a configuration file that sets the `Filesystem.MaxFileSize` property (and set the `ICE_CONFIG` variable or the `--Ice.Config` option accordingly), your application will pick up the configured value of the property.

30.8.2 Setting Properties

The `setProperty` operation sets a property to the specified value. (You can clear a property by setting it to the empty string.) This operation is useful only if you call it *before* you call `initialize`. This is because property values are (usually) read by the Ice run time only once, when you call `initialize`. The Ice run time does not guarantee that it will pay attention to a property value that is changed after you have initialized a communicator. Of course, this begs the question of how you can set a property value and have it also recognized by a communicator.

To permit you to set properties before initializing a communicator, the Ice run time provides an overloaded helper function called `createProperties` that creates a property set. In C++, the function is in the `Ice` namespace:

```
namespace Ice {

PropertiesPtr createProperties(const StringConverterPtr& = 0);
PropertiesPtr createProperties(StringSeq&,
                             const PropertiesPtr& = 0,
                             const StringConverterPtr& = 0);
PropertiesPtr createProperties(int&, char*[],
                             const PropertiesPtr& = 0,
                             const StringConverterPtr& = 0);

}
```

The `StringConverter` parameter allows you to parse properties whose values contain non-ASCII characters and to correctly convert this character into the native codeset. (See Section 31.21 for details.) The converter that is passed to `createProperties` remains attached to the returned property set for the life time of the property set.

The function is overloaded to accept either an `argc/argv` pair, or a `StringSeq` (see Section 30.8.3 for details.)

In C#, the `Util` class in the `Ice` namespace supplies equivalent methods:

```
namespace Ice {
    public sealed class Util {
        public static Properties createProperties();
        public static Properties
            createProperties(ref string[] args);
        public static Properties
```



```
        createProperties(ref string[] args,
                        Properties defaults);
    }
}
```

The Python and Ruby methods reside in the `Ice` module:

```
def createProperties(args=[])
```

In Java, the functions are static methods of the `Util` class inside the `Ice` package:

```
package Ice;

public final class Util
{
    public static Properties
    createProperties();

    public static Properties
    createProperties(StringSeqHolder args);

    public static Properties
    createProperties(StringSeqHolder args, Properties defaults);

    public static Properties
    createProperties(String[] args);

    public static Properties
    createProperties(String[] args, Properties defaults);

    // ...
}
```

As for `initialize` (see Section 31.3), `createProperties` strips Ice-related command-line options from the passed argument vector. (For Java, only the versions that accept a `StringSeqHolder` do this.)

Because Java cannot access environment variables, the Java implementation of `createProperties` always ignores the setting of the `ICE_CONFIG` environment variable. For the other languages, the functions behave as follows:

- The parameterless version of `createProperties` simply creates an empty property set. It does *not* check `ICE_CONFIG` for a configuration file to parse.
- The other overloads of `createProperties` accept an argument vector and a default property set. The returned property set contains all the property settings that are passed as the default, plus any property settings in the argu-

ment vector. If the argument vector sets a property that is also set in the passed default property set, the setting in the argument vector overrides the default.

The overloads that accept an argument vector also look for the `--Ice.Config` option; if the argument vector specifies a configuration file, the configuration file is parsed. The order of precedence of property settings, from lowest to highest, is:

- Property settings passed in the default parameter
- Property settings set in the configuration file
- Property settings in the argument vector.

The overloads that accept an argument vector also look for the setting of the `ICE_CONFIG` environment variable (except for Java) and, if that variable specifies a configuration file, parse that file. (However, an explicit `--Ice.Config` option in the argument vector or the `defaults` parameter overrides any setting of the `ICE_CONFIG` environment variable.)

`createProperties` is useful if you want to ensure that a property is set to a particular value, regardless of any setting of that property in a configuration file or in the argument vector. For example:

```
// Get the initialized property set.
//
Ice::PropertiesPtr props = Ice::createProperties(argc, argv);

// Make sure that network and protocol tracing are off.
//
props->setProperty("Ice.Trace.Network", "0");
props->setProperty("Ice.Trace.Protocol", "0");

// Initialize a communicator with these properties.
//
Ice::InitializationData id;
id.properties = props;
Ice::CommunicatorPtr ic = Ice::initialize(id);

// ...
```

The equivalent Python code is shown next:

```
props = Ice.createProperties(sys.argv)
props.setProperty("Ice.Trace.Network", "0")
props.setProperty("Ice.Trace.Protocol", "0")
id = Ice.InitializationData()
id.properties = props
ic = Ice.initialize(id)
```

This is the equivalent code in Ruby:

```
props = Ice::createProperties(ARGV)
props.setProperty("Ice.Trace.Network", "0")
props.setProperty("Ice.Trace.Protocol", "0")
id = Ice::InitializationData.new
id.properties = props
ic = Ice::initialize(id)
```

The equivalent Java code looks as follows:

```
Ice.StringSeqHolder argsH = new Ice.StringSeqHolder(args);
Ice.Properties properties = Ice.Util.createProperties(argsH);
properties.setProperty("Ice.Warn.Connections", "0");
properties.setProperty("Ice.Trace.Protocol", "0");
Ice.InitializationData id = new Ice.InitializationData();
id.properties = properties;
communicator = Ice.Util.initialize(id);
```

We first convert the argument array to an initialized `StringSeqHolder`. This is necessary so `createProperties` can strip Ice-specific settings. In that way, we first obtain an initialized property set, then override the settings for the two tracing properties, and then set the properties in the `InitializationData` structure.

30.8.3 Parsing Properties

The `Properties` interface provides three operations to convert and parse properties:

- `getCommandLineOptions`

This operation converts an initialized set of properties into a sequence of equivalent command-line options. For example, if you have set the `Filesystem.MaxFileSize` property to 1024 and call `getCommandLineOptions`, the setting is returned as the string `"Filesystem.MaxFileSize=1024"`. This operation is useful for diagnostic purposes, for example, to dump the setting of all properties to a logging facility (see Section 31.18), or if you want to fork a new process with the same property settings as the current process.

- `parseCommandLineOptions`

This operation examines the passed argument vector for command-line options that have the specified prefix. Any options that match the prefix are converted to property settings (that is, they initialize the corresponding properties). The operation returns an argument vector that contains all those options that were *not* converted (that is, those options that did not match the prefix).

Because `parseCommandLineOptions` expects a sequence of strings, but C++ programs are used to dealing with `argc` and `argv`, Ice provides two utility functions that convert an `argc/argv` vector into a sequence of strings and vice-versa:

```
namespace Ice {

    StringSeq argsToStringSeq(int argc, char* argv[]);

    void stringSeqToArgs(const StringSeq& args,
                        int& argc, char* argv[]);

}
```

You need to use `parseCommandLineOptions` (and the utility functions) if you want to permit application-specific properties to be set from the command line. For example, to permit the `--Filesystem.MaxFileSize` option to be used on the command line, we need to initialize our program as follows:

```
int
main(int argc, char* argv[])
{
    // Create an empty property set.
    //
    Ice::PropertiesPtr props = Ice::createProperties();

    // Convert argc/argv to a string sequence.
    //
    Ice::StringSeq args = Ice::argsToStringSeq(argc, argv);

    // Strip out all options beginning with --Filesystem.
    //
    args = props->parseCommandLineOptions("Filesystem", args);

    // args now contains only those options that were not
    // stripped. Any options beginning with --Filesystem have
    // been converted to properties.
```

```
// Convert remaining arguments back to argc/argv vector.
//
Ice::stringSeqToArgs(args, argc, argv);

// Initialize communicator.
//
Ice::InitializationData id;
id.props = props;
Ice::CommunicatorPtr ic = Ice::initialize(argc, argv, id);

// At this point, argc/argv only contain options that
// set neither an Ice property nor a Filesystem property,
// so we can parse these options as usual.
//
// ...
}
```

Using this code, any options beginning with **--Filesystem** are converted to properties and are available via the property lookup operations as usual. The call to `initialize` then removes any Ice-specific command-line options so, once the communicator is created, `argc/argv` only contains options and arguments that are not related to setting either a filesystem or an Ice property.

- `parseIceCommandLineOptions`

This operation behaves like `parseCommandLineOptions`, but removes the reserved Ice-specific options from the argument vector (see Section 30.2.2). It is used internally by the Ice run time to parse Ice-specific options in `initialize`.

30.8.4 Utility Operations

The Properties interface provides two utility operations:

- `clone`

This operation makes a copy of an existing property set. The copy contains exactly the same properties and values as the original.

- `load`

This operation accepts a pathname to a configuration file and initializes the property set from that file. If the specified file cannot be read (for example, because it does not exist or the caller does not have read permission), the operation throws a `FileNotFoundException`.

These operations are useful if you need to work with multiple communicators that use different property sets.

30.9 Summary

The Ice property mechanism provides a simple way to configure Ice by setting properties in configuration files or on the command line. This also applies to your own applications: you can easily use the `Properties` interface to access application-specific properties that you have created for your own needs. The API to access property values is small and simple, making it easy to retrieve property values at run time, yet is flexible enough to allow you to work with different property sets and configuration files if the need arises.

Chapter 30

Threads and Concurrency with C++

30.1 Chapter Overview

This chapter presents the C++ threading and signal handling abstractions that are provided by Ice. (For other language mappings, Ice uses the built-in threading and synchronization facilities.) We briefly describe how to use each of the available synchronization primitives (mutexes and monitors). We then cover how to create, control, and destroy threads. The threading discussion concludes with a brief example that shows how to create a thread-safe producer-consumer application that uses several threads. Finally, we introduce a portable abstraction for handling signals and signal-like events.

30.2 Introduction

Threading and concurrency control vary widely with different operating systems. To make threads programming easier and portable, Ice provides a simple thread abstraction layer that allows you to write portable source code regardless of the underlying platform. In this chapter, we take a closer look at the threading and concurrency control mechanisms in Ice for C++.

Note that we assume that you are familiar with light-weight threads and concurrency control. (See [8] for an excellent treatment of programming with

threads.) Also see Section 31.9, which provides a language-neutral introduction to the Ice threading model.

30.3 Library Overview

The Ice threading library provides the following thread-related abstractions:

- mutexes
- recursive mutexes
- read-write recursive mutexes
- monitors
- a thread abstraction that allows you to create, control, and destroy threads

The synchronization primitives permit you to implement concurrency control at different levels of granularity. In addition, the thread abstraction allows you to, for example, create a separate thread that can respond to GUI or other asynchronous events. All of the threading APIs are part of the `IceUtil` namespace.

30.4 Mutexes

The classes `IceUtil::Mutex` (defined in `IceUtil/Mutex.h`) and `IceUtil::StaticMutex` (defined in `IceUtil/StaticMutex.h`) provide simple non-recursive mutual exclusion mechanisms:

```
namespace IceUtil {  
  
    class Mutex {  
    public:  
        Mutex();  
        ~Mutex();  
        void lock() const;  
        bool tryLock() const;  
        void unlock() const;  
  
        typedef LockT<Mutex> Lock;  
        typedef TryLockT<Mutex> TryLock;  
    };  
  
    struct StaticMutex {  
        void lock() const;
```



```
bool tryLock() const;
void unlock() const;

typedef LockT<StaticMutex> Lock;
typedef TryLockT<StaticMutex> TryLock;
};
}
```

`IceUtil::Mutex` and `IceUtil::StaticMutex` have identical behavior, but `IceUtil::StaticMutex` is implemented as a simple data structure¹ so that instances can be declared statically and initialized during compilation, as demonstrated below.

```
static IceUtil::StaticMutex myStaticMutex =
    ICE_STATIC_MUTEX_INITIALIZER;
```

The preprocessor macro `ICE_STATIC_MUTEX_INITIALIZER` is defined to correctly initialize the data members of `IceUtil::StaticMutex`. Instances of `IceUtil::StaticMutex` are never destroyed.

`IceUtil::Mutex`, on the other hand, is implemented as a class and therefore is initialized by its constructor and destroyed by its destructor.

The member functions of these classes work as follows:

- `lock`

The `lock` function attempts to acquire the mutex. If the mutex is already locked, it suspends the calling thread until the mutex becomes available. The call returns once the calling thread has acquired the mutex.

- `tryLock`

The `tryLock` function attempts to acquire the mutex. If the mutex is available, the call returns with the mutex locked and returns `true`. Otherwise, if the mutex is locked by another thread, the call returns `false`.

- `unlock`

The `unlock` function unlocks the mutex.

Note that `IceUtil::Mutex` and `IceUtil::StaticMutex` are non-recursive mutex implementations. This means that you must adhere to the following rules:

1. In ISO C++ terminology, `StaticMutex` is “plain old data” (POD).

- Do not call `lock` on the same mutex more than once from a thread. The mutex is not recursive so, if the owner of a mutex attempts to lock it a second time, the behavior is undefined.
- Do not call `unlock` on a mutex unless the calling thread holds the lock. Calling `unlock` on a mutex that is not currently held by any thread, or calling `unlock` on a mutex that is held by a different thread, results in undefined behavior.

30.4.1 Thread-Safe File Access for the Filesystem Application

Recall that the implementation of the `read` and `write` operations for our file system server in Section 9.2.3 is not thread safe:

```
Filesystem::Lines
Filesystem::FileI::read(const Ice::Current&) const
{
    return _lines;    // Not thread safe!
}

void
Filesystem::FileI::write(const Filesystem::Lines& text,
                        const Ice::Current&)
{
    _lines = text;    // Not thread safe!
}
```

The problem here is that, if we receive concurrent invocations of `read` and `write`, one thread will be assigning to the `_lines` vector while another thread is reading that same vector. The outcome of such concurrent data access is undefined; to avoid the problem, we need to serialize access to the `_lines` member with a mutex. We can make the mutex a data member of the `FileI` class and lock and unlock it in the `read` and `write` operations:

```
#include <IceUtil/Mutex.h>
// ...

namespace Filesystem {
    // ...

    class FileI : virtual public File,
                  virtual public Filesystem::NodeI {
    public:
        // As before...
    private:
```

```
        Lines _lines;
        IceUtil::Mutex _fileMutex;
    };
    // ...
}

Filesystem::Lines
Filesystem::FileI::read(const Ice::Current&) const
{
    _fileMutex.lock();
    Lines l = _lines;
    _fileMutex.unlock();
    return l;
}

void
Filesystem::FileI::write(const Filesystem::Lines& text,
                        const Ice::Current&)
{
    _fileMutex.lock();
    _lines = text;
    _fileMutex.unlock();
}
```

The `FileI` class here is identical to the implementation in Section 9.2.2, except that we have added the `_fileMutex` data member. The `read` and `write` operations lock and unlock the mutex to ensure that only one thread can read or write the file at a time. Note that, by using a separate mutex for each `FileI` instance, it is still possible for multiple threads to concurrently read or write files, as long as they each access a *different* file. Only concurrent accesses to the *same* file are serialized.

The implementation of `read` is somewhat awkward here: we must make a local copy of the file contents while we are holding the lock and return that copy. Doing so is necessary because we must unlock the mutex before we can return from the function. However, as we will see in the next section, the copy can be avoided by using a helper class that unlocks the mutex automatically when the function returns.

30.4.2 Guaranteed Unlocking of Mutexes

Using the raw `lock` and `unlock` operations on mutexes has an inherent problem: if you forget to unlock a mutex, your program will deadlock. Forgetting to unlock a mutex is easier than you might suspect, for example:

```

Filesystem::Lines
Filesystem::File::read(const Ice::Current&) const
{
    _fileMutex.lock();           // Lock the mutex
    Lines l = readFileContents(); // Read from database
    _fileMutex.unlock();        // Unlock the mutex
    return l;
}

```

Assume that we are keeping the contents of the file on secondary storage, such as a database, and that the `readFileContents` function accesses the file. The code is almost identical to the previous example but now contains a latent bug: if `readFileContents` throws an exception, the `read` function terminates without ever unlocking the mutex. In other words, this implementation of `read` is not exception-safe.

The same problem can easily arise if you have a larger function with multiple return paths. For example:

```

void
SomeClass::someFunction(/* params here... */)
{
    _mutex.lock();           // Lock a mutex

    // Lots of complex code here...

    if (someCondition) {
        // More complex code here...
        return;             // Oops!!!
    }

    // More code here...

    _mutex.unlock();        // Unlock the mutex
}

```

In this example, the early return from the middle of the function leaves the mutex locked. Even though this example makes the problem quite obvious, in large and complex pieces of code, both exceptions and early returns can cause hard-to-track deadlock problems. To avoid this, the `Mutex` class contains two type definitions for helper classes, called `Lock` and `TryLock`:

```

namespace IceUtil {

    class Mutex {
        // ...
    }
}

```

```

        typedef LockT<Mutex> Lock;
        typedef TryLockT<Mutex> TryLock;
    };
}

```

`LockT` and `TryLockT` are simple templates that primarily consist of a constructor and a destructor; the constructor calls `lock` on its argument, and the destructor calls `unlock`. By instantiating a local variable of type `Lock` or `TryLock`, we can avoid the deadlock problem entirely:²

```

void
SomeClass::someFunction(/* params here... */)
{
    IceUtil::Mutex::Lock lock(_mutex); // Lock a mutex

    // Lots of complex code here...

    if (someCondition) {
        // More complex code here...
        return; // No problem
    }

    // More code here...
} // Destructor of lock unlocks the mutex

```

On entry to `someFunction`, we instantiate a local variable `lock`, of type `IceUtil::Mutex::Lock`. The constructor of `lock` calls `lock` on the mutex so the remainder of the function is inside a critical region. Eventually, `someFunction` returns, either via an ordinary return (in the middle of the function or at the end) or because an exception was thrown somewhere in the function body. Regardless of how the function terminates, the C++ run time unwinds the stack and calls the destructor of `lock`, which unlocks the mutex, so we cannot get trapped by the deadlock problem we had previously.

You should make it a habit to always use the `Lock` and `TryLock` helpers instead of calling `lock` and `unlock` directly. Doing so results in code that is easier to understand and maintain.

Using the `Lock` helper, we can rewrite the implementation of our `read` and `write` operations as follows:

2. This is an example of the *RAII* (*Resource Acquisition Is Initialization*) idiom [20].

```
Filesystem::Lines
Filesystem::FileI::read(const Ice::Current&) const
{
    IceUtil::Mutex::Lock lock(_fileMutex);
    return _lines;
}

void
Filesystem::FileI::write(const Filesystem::Lines& text,
                        const Ice::Current&)
{
    IceUtil::Mutex::Lock lock(_fileMutex);
    _lines = text;
}
```

Note that this also eliminates the need to make a copy of the `_lines` data member: the return value is initialized under protection of the mutex and cannot be modified by another thread once the destructor of `lock` unlocks the mutex.

30.5 Recursive Mutexes

As we saw on page 740, a non-recursive mutex cannot be locked more than once, even by the thread that holds the lock. This frequently becomes a problem if a program contains a number of functions, each of which must acquire a mutex, and you want to call one function as part of the implementation of another function:

```
IceUtil::Mutex _mutex;

void
f1()
{
    IceUtil::Mutex::Lock lock(_mutex);
    // ...
}

void
f2()
{
    IceUtil::Mutex::Lock lock(_mutex);
    // Some code here...

    // Call f1 as a helper function
```

```
f1(); // Deadlock!  
  
// More code here...  
}
```

`f1` and `f2` each correctly lock the mutex before manipulating data but, as part of its implementation, `f2` calls `f1`. At that point, the program deadlocks because `f2` already holds the lock that `f1` is trying to acquire. For this simple example, the problem is obvious. However, in complex systems with many functions that acquire and release locks, it can get very difficult to track down this kind of situation: the locking conventions are not manifest anywhere but in the source code and each caller must know which locks to acquire (or not to acquire) before calling a function. The resulting complexity can quickly get out of hand.

Ice provides a recursive mutex class `RecMutex` (defined in `IceUtil/RecMutex.h`) that avoids this problem:

```
namespace IceUtil {  
  
    class RecMutex {  
    public:  
        void lock() const;  
        bool tryLock() const;  
        void unlock() const;  
  
        typedef LockT<RecMutex> Lock;  
        typedef TryLockT<RecMutex> TryLock;  
    };  
}
```

Note that the signatures of the operations are the same as for `IceUtil::Mutex`. However, `RecMutex` implements a recursive mutex:

- `lock`

The `lock` function attempts to acquire the mutex. If the mutex is already locked by another thread, it suspends the calling thread until the mutex becomes available. If the mutex is available or is already locked by the calling thread, the call returns immediately with the mutex locked.

- `tryLock`

The `tryLock` function works like `lock`, but, instead of blocking the caller, it returns `false` if the mutex is locked by another thread. Otherwise, the return value is `true`.

- `unlock`

The `unlock` function unlocks the mutex.

As for non-recursive mutexes, you must adhere to a few simple rules for recursive mutexes:

- Do not call `unlock` on a mutex unless the calling thread holds the lock.
- You must call `unlock` as many times as you called `lock` for the mutex to become available to another thread. (Internally, a recursive mutex is implemented with a counter that is initialized to zero. Each call to `lock` increments the counter and each call to `unlock` decrements the counter; the mutex is made available to another thread when the counter returns to zero.)

Using recursive mutexes, the code fragment on page 744 works correctly:

```
#include <IceUtil/RecMutex.h>
// ...

IceUtil::RecMutex _mutex;          // Recursive mutex

void
f1()
{
    IceUtil::RecMutex::Lock lock(_mutex);
    // ...
}

void
f2()
{
    IceUtil::RecMutex::Lock lock(_mutex);
    // Some code here...

    // Call f1 as a helper function
    f1();                               // Fine

    // More code here...
}
```

Note that the type of the mutex is now `RecMutex` instead of `Mutex`, and that we are using the `Lock` type definition provided by the `RecMutex` class, not the one provided by the `Mutex` class.

30.6 Read-Write Recursive Mutexes

The implementation of our `read` and `write` operations on page 744 is more conservative in its locking than strictly necessary: only one thread can be in either the `read` or `write` operation at a time. However, we have problems with concurrent file access only if we have concurrent writers, or concurrent readers and writers for the same file. However, if we have only readers, there is no need to serialize access for all the reading threads because none of them updates the file contents.

Ice provides a read-write recursive mutex class `RWRecMutex` (defined in `IceUtil/RWRecMutex.h`) that implements a reader-writer lock:

```
namespace IceUtil {  
  
    class RWRecMutex {  
    public:  
        void readLock() const;  
        bool tryReadLock() const;  
        bool timedReadLock(const Time&) const;  
  
        void writeLock() const;  
        bool tryWriteLock() const;  
        bool timedWriteLock(const Time&) const;  
  
        void unlock() const;  
  
        void upgrade() const;  
        bool timedUpgrade(const Time&) const;  
        void downgrade() const;  
  
        typedef RLockT<RWRecMutex> RLock;  
        typedef TryRLockT<RWRecMutex> TryRLock;  
        typedef WLockT<RWRecMutex> WLock;  
        typedef TryWLockT<RWRecMutex> TryWLock;  
    };  
}
```

A read-write recursive mutex splits the usual single `lock` operation into `readLock` and `writeLock` operations. Multiple readers can each acquire the mutex in parallel. However, only a single writer can hold the mutex at any one time (with neither other readers nor other writers being present). A `RWRecMutex` is recursive, meaning that you can call `readLock` or `writeLock` multiple times from the same calling thread.

The member functions behave as follows:

- `readLock`

This function acquires a read lock. If a writer currently holds the mutex or a thread is waiting for a lock upgrade, the caller is suspended until the mutex becomes available for reading. If the mutex is available, or only readers currently hold the mutex, the call returns immediately with the mutex locked.

- `tryReadLock`

This function attempts to acquire a read lock. If the lock is currently held by a writer or a thread is waiting for a lock upgrade, the function returns `false`. Otherwise, it acquires the lock and returns `true`.

- `timedReadLock`

This function attempts to acquire a read lock. If the lock is currently held by a writer or another thread is waiting for an upgrade, the function waits for the specified timeout. If the lock can be acquired within the timeout, the function returns `true` with the lock held. Otherwise, once the timeout expires, the function returns `false`. (See Section 30.7 for how to construct a timeout value.)

- `writeLock`

This function acquires a write lock. If readers or a writer currently hold the mutex or another thread is waiting for an upgrade, the caller is suspended until the mutex becomes available for writing. If the mutex is available, the call returns immediately with the lock held.

- `tryWriteLock`

This function attempts to acquire a write lock. If the lock is currently held by readers or a writer, or if another thread is waiting for an upgrade, the function returns `false`. Otherwise, it acquires the lock and returns `true`.

- `timedWriteLock`

This function attempts to acquire a write lock. If the lock is currently held by readers or a writer, or if another thread is waiting for an upgrade, the function waits for the specified timeout. If the lock can be acquired within the timeout, the function returns `true` with the lock held. Otherwise, once the timeout expires, the function returns `false`. (See Section 30.7 for how to construct a timeout value.)

- `unlock`

This function unlocks the mutex (whether currently held for reading or writing).

- `upgrade`

This function upgrades a read lock to a write lock. If other readers currently hold the mutex, the caller is suspended until the mutex becomes available for writing. If the mutex is available, the call returns immediately with the lock held.

Only one reader can attempt to upgrade a lock at a time. If several threads call `upgrade`, all but the first thread receive a `DeadlockException`.

Note that `upgrade` is non-recursive. Do not call it more than once from the same thread.

- `timedUpgrade`

This function attempts to upgrade a read lock to a write lock. If the lock is currently held by other readers, the function waits for the specified timeout. If the lock can be acquired within the timeout, the function returns `true` with the lock held. Otherwise, once the timeout expires, the function returns `false`. (See Section 30.7 for how to construct a timeout value.) If another thread is waiting to upgrade the lock, `timedUpgrade` returns `false` immediately.

Note that `timedUpgrade` is non-recursive. Do not call it more than once from the same thread.

- `downgrade`

This function converts a write lock to a read lock.

As for non-recursive and recursive mutexes, you must adhere to a few rules for correct use of read-write locks:

- Do not call `unlock` on a mutex unless the calling thread holds the lock.
- You must call `unlock` as many times as you called `readLock` or `writeLock` (or `upgrade` or successful `timedUpgrade`) for the mutex to become available to another thread.
- Do not call `upgrade` or `timedUpgrade` on a mutex for which you do not hold a read lock.
- `upgrade` and `timedUpgrade` are non-recursive (because making them recursive would incur an unacceptable performance penalty). Do not call these methods more than once from the same thread.

- Do not call `downgrade` on a mutex unless the calling thread holds a write lock.
- You must call `downgrade` (or `unlock`) as many times as you called `writeLock` and `upgrade` (or successfully called `timedUpgrade`) for the mutex to become available to another thread.

The implementation of read-write recursive mutexes gives preference to writers: if a writer is waiting to acquire the lock, no new readers are permitted to acquire the lock; the implementation waits until all current readers relinquish the lock and then locks the mutex for the waiting writer. Similarly, the implementation gives preference to a thread that wants to upgrade the lock; no new readers or writers can acquire the lock until the upgrade is complete.

Note that mutexes do not implement any notion of fairness: if multiple writers are continuously waiting to acquire a write lock, which writer gets the lock next depends on the underlying threads implementation. There is no queue of waiting writers to ensure that none of the writers are permanently starved of access to the mutex.

Using a `RWRecMutex`, we can implement our read and write operations to allow multiple readers in parallel, or a single writer:

```
#include <IceUtil/RWRecMutex.h>
// ...

namespace Filesystem {
    // ...

    class FileI : virtual public File,
                  virtual public Filesystem::NodeI {
    public:
        // As before...
    private:
        Lines _lines;
        IceUtil::RWRecMutex _fileMutex; // Read-write mutex
    };
    // ...
}

Filesystem::Lines
Filesystem::FileI::read(const Ice::Current&) const
{
    IceUtil::RWRecMutex::RLock lock(_fileMutex); // Read lock
    return _lines;
}
```

```
void
Filesystem::FileI::write(const Filesystem::Lines& text,
                        const Ice::Current&)
{
    IceUtil::RWRecMutex::WLock lock(_fileMutex);    // Write lock
    _lines = text;
}
```

This code is almost identical to the non-recursive version on page 740. Note that the only changes are that we have changed the type of the mutex in the servant to `RWRecMutex` and that we are using the `RLock` and `WLock` helpers to guarantee unlocking instead of calling `readLock` and `writeLock` directly.

30.7 Timed Locks

As we saw on page 747, read-write locks provide member functions that operate with a timeout. The amount of time to wait is specified by an instance of the `IceUtil::Time` class (defined in `IceUtil/Time.h`):

```
namespace IceUtil {

    class Time {
    public:
        Time();
        static Time now();
        static Time seconds(long long);
        static Time milliseconds(long long);
        static Time microseconds(long long);

        long long toSeconds() const;
        long long toMilliseconds() const;
        long long toMicroseconds() const;

        double toSecondsDouble() const;
        double toMillisecondsDouble() const;
        double toMicrosecondsDouble() const;

        std::string toDateTime() const;
        std::string toDuration() const;

        Time operator-() const;
```

```

Time operator-(const Time&) const;
Time operator+(const Time&) const;

Time operator*(int) const;
Time operator*(long long) const;
Time operator*(double) const;

double operator/(const Time&) const;
Time operator/(int) const;
Time operator/(long long) const;
Time operator/(double) const;

Time& operator--(const Time&);
Time& operator+=(const Time&);

Time& operator*=(int);
Time& operator*=(long long);
Time& operator*=(double);

Time& operator/=(int);
Time& operator/=(long long);
Time& operator/=(double);

bool operator<(const Time&) const;
bool operator<=(const Time&) const;
bool operator>(const Time&) const;
bool operator>=(const Time&) const;
bool operator==(const Time&) const;
bool operator!=(const Time&) const;

#ifdef _WIN32
operator timeval() const;
#endif
};
}

```

The `Time` class provides basic facilities for getting the current time, constructing time intervals, adding and subtracting times, and comparing times:

- `Time`

Internally, the `Time` class stores ticks in microsecond units. For absolute time, this is the number of microseconds since the UNIX epoch (00:00:00 UTC on 1 Jan. 1970). For durations, this is the number of microseconds in the duration. The default constructor initializes the tick count to zero.

- `now`

This function constructs a `Time` object that is initialized to the current time of day.

- `seconds`
`milliSeconds`
`microSeconds`

These functions construct `Time` objects from the argument in the specified units. For example, the following code fragment creates a time duration of one minute:

```
IceUtil::Time t = IceUtil::Time::seconds(60);
```

- `toSeconds`
`toMilliSeconds`
`toMicroSeconds`

The member functions provide explicit conversion of a duration to seconds, milliseconds, and microseconds, respectively. The return value is a 64-bit signed integer (`long long`).

```
IceUtil::Time t = IceUtil::Time::milliSeconds(2000);  
long long secs = t.toSeconds(); // Returns 2
```

- `toSecondsDouble`
`toMilliSecondsDouble`
`toMicroSecondsDouble`

The member functions provide explicit conversion of a duration to seconds, milliseconds, and microseconds, respectively. The return value is of type `double`.

- `toDateTime`

This function returns a human-readable representation of a `Time` value as a date and time.

- `toDuration`

This function returns a human-readable representation fo a `Time` value as a duration.

- `operator-`
`operator+`
`operator*`
`operator/`
`operator-=`

```
operator+=
operator*=
operator/=
```

These operators allow you to add, subtract, multiply, and divide times. For example:

```
IceUtil::Time oneMinute = IceUtil::Time::seconds(60);
IceUtil::Time oneMinuteAgo = IceUtil::Time::now() - oneMinute;
```

The multiplication and division operators permit you to multiply and divide a duration. Note that these operators provide overloads for `int`, `long`, `long`, and `double`.

- The comparison operators allow you to compare times and time intervals with each other, for example:

```
IceUtil::Time oneMinute = IceUtil::Time::seconds(60);
IceUtil::Time twoMinutes = IceUtil::Time::seconds(120);
assert(oneMinute < twoMinutes);
```

- `operator timeval`

This operator converts a `Time` object to a `struct timeval`, defined as follows:

```
struct timeval {
    long tv_sec;
    long tv_usec;
};
```

The conversion is useful for API calls that require a `struct timeval` argument, such as `select`. To convert a duration into a `timeval` structure, simply assign a `Time` object to a `struct timeval`:

```
IceUtil::Time oneMinute = IceUtil::Time::seconds(60);
struct timeval tv;
tv = t;
```

Note that this member function is not available under Windows.

Using a `Time` object with a timed lock operation is trivial, for example:

```
#include <IceUtil/RWRecMutex.h>

// ...
IceUtil::RWRecMutex _mutex;

// ...
```



```
// Wait for up to two seconds to get a write lock...
//
IceUtil::RWRecMutex::TryWLock
    lock(_mutex, IceUtil::Time::seconds(2));

if(lock.acquired())
{
    // Got the lock -- destructor of lock will unlock
}
else
{
    // Waited for two seconds without getting the lock...
}
```

Note that the `TryRLock` and `TryWLock` constructors are overloaded: if you supply only a mutex as the sole argument, the constructor calls `tryReadLock` or `tryWriteLock`; if you supply both a mutex and a timeout, the constructor calls `timedReadLock` or `timedWriteLock`.

30.8 Monitors

Mutexes implement a simple mutual exclusion mechanism that allows only a single thread (or, in the case of read-write mutexes, a single writer thread or multiple reader threads) to be active in a critical region at a time. In particular, for another thread to enter the critical region, another thread must leave it. This means that, with mutexes, it is impossible to suspend a thread inside a critical region and have that thread wake up again at a later time, for example, when a condition becomes true.

To address this problem, Ice provides a monitor. Briefly, a monitor is a synchronization mechanism that protects a critical region: as for a mutex, only one thread may be active at a time inside the critical region. However, a monitor allows you to suspend a thread inside the critical region; doing so allows another thread to enter the critical region. The second thread can either leave the monitor (thereby unlocking the monitor), or it can suspend itself inside the monitor; either way, the original thread is woken up and continues execution inside the monitor. This extends to any number of threads, so several threads can be suspended inside a monitor.³

Monitors provide a more flexible mutual exclusion mechanism than mutexes because they allow a thread to check a condition and, if the condition is false, put

itself to sleep; the thread is woken up by some other thread that has changed the condition.

30.8.1 The Monitor Class

Ice provides monitors with the `IceUtil::Monitor` class (defined in `IceUtil/Monitor.h`):

```
namespace IceUtil {  
  
    template <class T>  
    class Monitor {  
    public:  
        void lock() const;  
        void unlock() const;  
        bool tryLock() const;  
  
        void wait() const;  
        bool timedWait(const Time&) const;  
        void notify();  
        void notifyAll();  
  
        typedef LockT<Monitor<T> > Lock;  
        typedef TryLockT<Monitor<T> > TryLock;  
    };  
}
```

Note that `Monitor` is a template class that requires either `Mutex` or `RecMutex` as its template parameter. (Instantiating a `Monitor` with a `RecMutex` makes the monitor recursive.)

The member functions behave as follows:

- `lock`

This function attempts to lock the monitor. If the monitor is currently locked by another thread, the calling thread is suspended until the monitor becomes available. The call returns with the monitor locked.

-
3. The monitors provided by Ice have *Mesa* semantics, so called because they were first implemented by the Mesa programming language [12]. Mesa monitors are provided by a number of languages, including Java and Ada. With Mesa semantics, the signalling thread continues to run and another thread gets to run only once the signalling thread suspends itself or leaves the monitor.

- `tryLock`

This function attempts to lock a monitor. If the monitor is available, the call returns `true` with the monitor locked. If the monitor is locked by another thread, the call returns `false`.
- `unlock`

This function unlocks a monitor. If other threads are waiting to enter the monitor (are blocked inside a call to `lock`), one of the threads is woken up and locks the monitor.
- `wait`

This function suspends the calling thread and, at the same time, releases the lock on the monitor. A thread suspended inside a call to `wait` can be woken up by another thread that calls `notify` or `notifyAll`. When the call returns, the suspended thread resumes execution with the monitor locked.
- `timedWait`

This function suspends the calling thread for up to the specified timeout. If another thread calls `notify` or `notifyAll` and wakes up the suspended thread before the timeout expires, the call returns `true` and the suspended thread resumes execution with the monitor locked. Otherwise, if the timeout expires, the function returns `false`.
- `notify`

This function wakes up a single thread that is currently suspended in a call to `wait`. If no thread is suspended in a call to `wait` at the time `notify` is called, the notification is lost (that is, calls to `notify` are *not* remembered if there is no thread to be woken up).

Note that notifying does not run another thread immediately. Another thread gets to run only once the notifying thread either calls `wait` or unlocks the monitor (Mesa semantics).
- `notifyAll`

This function wakes up all threads that are currently suspended in a call to `wait`. As for `notify`, calls to `notifyAll` are lost if no threads are suspended at the time.

As for `notify`, `notifyAll` causes other threads to run only once the notifying thread has either called `wait` or unlocked the monitor (Mesa semantics).

You must adhere to a few rules for monitors to work correctly:

- Do not call `unlock` unless you hold the lock. If you instantiate a monitor with a recursive mutex, you get recursive semantics, that is, you must call `unlock` as many times as you have called `lock` (or `tryLock`) for the monitor to become available.
- Do not call `wait` or `timedWait` unless you hold the lock.
- Do not call `notify` or `notifyAll` unless you hold the lock.
- When returning from a `wait` call, you *must* re-test the condition before proceeding (see page 760).

30.8.2 Using Monitors

To illustrate how to use a monitor, consider a simple unbounded queue of items. A number of producer threads add items to the queue, and a number of consumer threads remove items from the queue. If the queue becomes empty, consumers must wait until a producer puts a new item on the queue. The queue itself is a critical region, that is, we cannot allow a producer to put an item on the queue while a consumer is removing an item. Here is a very simple implementation of a such a queue:

```
template<class T> class Queue {
public:
    void put(const T& item) {
        _q.push_back(item);
    }

    T get() {
        T item = _q.front();
        _q.pop_front();
        return item;
    }

private:
    list<T> _q;
};
```

As you can see, producers call the `put` method to enqueue an item, and consumers call the `get` method to dequeue an item. Obviously, this implementation of the queue is not thread-safe and there is nothing to stop a consumer from attempting to dequeue an item from an empty queue.

Here is a version of the queue that uses a monitor to suspend a consumer if the queue is empty:

```

#include <IceUtil/Monitor.h>

template<class T> class Queue
    : public IceUtil::Monitor<IceUtil::Mutex> {
public:
    void put(const T& item) {
        IceUtil::Monitor<IceUtil::Mutex>::Lock lock(*this);
        _q.push_back(item);
        notify();
    }

    T get() {
        IceUtil::Monitor<IceUtil::Mutex>::Lock lock(*this);
        while (_q.size() == 0)
            wait();
        T item = _q.front();
        _q.pop_front();
        return item;
    }

private:
    list<T> _q;
};

```

Note that the `Queue` class now inherits from `IceUtil::Monitor<IceUtil::Mutex>`, that is, `Queue` *is-a* monitor.

Both the `put` and `get` methods lock the monitor when they are called. As for mutexes, instead of calling `lock` and `unlock` directly, we are using the `Lock` helper which automatically locks the monitor when it is instantiated and unlocks the monitor again when it is destroyed.

The `put` method first locks the monitor and then, now being in sole possession of the critical region, enqueues an item. Before returning (thereby unlocking the monitor), `put` calls `notify`. The call to `notify` will wake up any consumer thread that may be asleep in a `wait` call to inform the consumer that an item is available.

The `get` method also locks the monitor and then, before attempting to dequeue an item, tests whether the queue is empty. If so, the consumer calls `wait`. This suspends the consumer inside the `wait` call and unlocks the monitor, so a producer can enter the monitor to enqueue an item. Once that happens, the producer calls `notify`, which causes the consumer's `wait` call to complete, with the monitor again locked for the consumer. The consumer now dequeues an item and returns (thereby unlocking the monitor).

For this machinery to work correctly, the implementation of `get` does two things:

- `get` tests whether the queue is empty *after* acquiring the lock.
- `get` re-tests the condition in a loop around the call to `wait`; if the queue is still empty after `wait` returns, the `wait` call is re-entered.

You *must* always write your code to follow the same pattern:

- *Never* test a condition unless you hold the lock.
- *Always* re-test the condition in a loop around `wait`. If the test still shows the wrong outcome, call `wait` again.

Not adhering to these conditions will eventually result in a thread accessing shared data when it is not in its expected state, for the following reasons:

1. If you test a condition without holding the lock, there is nothing to prevent another thread from entering the monitor and changing its state before you can acquire the lock. This means that, by the time you get around to locking the monitor, the state of the monitor may no longer be in agreement with the result of the test.
2. Some thread implementations suffer from a problem known as *spurious wake-up*: occasionally, more than one thread may wake up in response to a call to `notify`, or a thread may wake up without any call to `notify` at all. As a result, each thread that returns from a call to `wait` must re-test the condition to ensure that the monitor is in its expected state: the fact that `wait` returns does *not* indicate that the condition has changed.

30.8.3 Efficient Notification

The previous implementation of our thread-safe queue on page 759 unconditionally notifies a waiting reader whenever a writer deposits an item into the queue. If no reader is waiting, the notification is lost and does no harm. However, unless there is only a single reader and writer, many notifications will be sent unnecessarily, causing unwanted overhead.

Here is one way to fix the problem:

```
#include <IceUtil/Monitor.h>

template<class T> class Queue
    : public IceUtil::Monitor<IceUtil::Mutex> {
public:
    void put(const T& item) {
```

```
        IceUtil::Monitor<IceUtil::Mutex>::Lock lock(*this);
        _q.push_back(item);
        if (_q.size() == 1)
            notify();
    }

    T get() {
        IceUtil::Monitor<IceUtil::Mutex>::Lock lock(*this);
        while (_q.size() == 0)
            wait();
        T item = _q.front();
        _q.pop_front();
        return item;
    }

private:
    list<T> _q;
};
```

The only difference between this code and the implementation on page 759 is that a writer calls `notify` only if the queue length has just changed from empty to non-empty. That way, unnecessary `notify` calls are never made. However, this approach works only for a single reader thread. To see why, consider the following scenario:

1. Assume that the queue currently contains a number of items and that we have five reader threads.
2. The five reader threads continue to call `get` until the queue becomes empty and all five readers are waiting in `get`.
3. The scheduler schedules a writer thread. The writer finds the queue empty, deposits an item, and wakes up a single reader thread.
4. The awakened reader thread dequeues the single item on the queue.
5. The reader calls `get` a second time, finds the queue empty, and goes to sleep again.

The net effect of this is that there is a good chance that only one reader thread will ever be active; the other four reader threads end up being permanently asleep inside the `get` method.

One way around this problem is call `notifyAll` instead of `notify` once the queue length exceeds a certain amount, for example:

```
#include <IceUtil/Monitor.h>

template<class T> class Queue
    : public IceUtil::Monitor<IceUtil::Mutex> {
public:
    void put(const T& item) {
        IceUtil::Monitor<IceUtil::Mutex>::Lock lock(*this);
        _q.push_back(item);
        if (_q.size() >= _wakeupThreshold)
            notifyAll();
    }

    T get() {
        IceUtil::Monitor<IceUtil::Mutex>::Lock lock(*this);
        while (_q.size() == 0)
            wait();
        T item = _q.front();
        _q.pop_front();
        return item;
    }

private:
    list<T> _q;
    const int _wakeupThreshold = 100;
};
```

Here, we have added a private data member `_wakeupThreshold`; a writer wakes up *all* waiting readers once the queue length exceeds the threshold, in the expectation that all the readers will consume items more quickly than they are produced, thereby reducing the queue length below the threshold again.

This approach works, but has drawbacks as well:

- The appropriate value of `_wakeupThreshold` is difficult to determine and sensitive to things such as speed and number of processors and I/O bandwidth.
- If multiple readers are asleep, they are all made runnable by the thread scheduler once a writer calls `notifyAll`. On a multiprocessor machine, this may result in all readers running at once (one per CPU). However, as soon as the readers are made runnable, each of them attempts to reacquire the mutex that protects the monitor before returning from `wait`. Of course, only one of the readers actually succeeds and the remaining readers are suspended again, waiting for the mutex to become available. The net result is a large number of thread context switches as well as repeated and unnecessary locking of the system bus.

A better option than calling `notifyAll` is to wake up waiting readers one at a time. To do this, we keep track of the number of waiting readers and call `notify` only if a reader needs to be woken up:

```
#include <IceUtil/Monitor.h>

template<class T> class Queue
    : public IceUtil::Monitor<IceUtil::Mutex> {
public:
    Queue() : _waitingReaders(0) {}

    void put(const T& item) {
        IceUtil::Monitor<IceUtil::Mutex>::Lock lock(*this);
        _q.push_back(item);
        if (_waitingReaders)
            notify();
    }

    T get() {
        IceUtil::Monitor<IceUtil::Mutex>::Lock lock(*this);
        while (_q.size() == 0) {
            try {
                ++_waitingReaders;
                wait();
                --_waitingReaders;
            } catch (...) {
                --_waitingReaders;
                throw;
            }
        }
        T item = _q.front();
        _q.pop_front();
        return item;
    }

private:
    list<T> _q;
    short _waitingReaders;
};
```

This implementation uses a member variable `_waitingReaders` to keep track of the number of readers that are suspended. The constructor initializes the variable to zero and the implementation of `get` increments and decrements the variable around the call to `wait`. Note that these statements are enclosed in a `try-catch` block; this ensures that the count of waiting readers remains accurate even

if `wait` throws an exception. Finally, `put` calls `notify` only if there is a waiting reader.

The advantage of this implementation is that it minimizes contention on the monitor mutex: a writer wakes up only a single reader at a time, so we do not end up with multiple readers simultaneously trying to lock the mutex. Moreover, the monitor `notify` implementation signals a waiting thread only *after* it has unlocked the mutex. This means that, when a thread wakes up from its call to `wait` and tries to reacquire the mutex, the mutex is likely to be unlocked. This results in more efficient operation because acquiring an unlocked mutex is typically very efficient, whereas forcefully putting a thread to sleep on a locked mutex is expensive (because it forces a thread context switch).

30.9 Efficiency Considerations

The mutual exclusion mechanisms provided by Ice differ in their size and speed. Table 30.1 shows the relative sizes for Windows and Linux (both on Intel architectures).

Table 30.1. Size of mutual exclusion primitives.

Primitive	Size in Bytes (Windows)	Size in Bytes (Linux)
<code>Mutex</code>	24	24
<code>RecMutex</code>	28	28
<code>RWRecMutex</code>	172	184
<code>Monitor<Mutex></code>	72	76
<code>Monitor<RecMutex></code>	76	80

Table 30.2 shows the relative performance of the different synchronization primitives under conditions of no lock contention.

Table 30.2. Relative performance of mutual exclusion primitives.

Primitive	Speed (Windows)	Speed (Linux)
Mutex	1.00	1.00
RecMutex	1.02	1.25
RWRecMutex	12.24 (read lock) 22.45 (write lock)	3.23 (read lock) 3.40 (write lock)
Monitor<Mutex>	0.86	1.09
Monitor<RecMutex>	0.90	1.30

Note that the size and performance differences between a mutex and a recursive mutex are negligible, so you should use a non-recursive mutex only if you have a very small critical region that is accessed repeatedly in a tight loop. Similarly, monitors perform much the same as mutexes (but do have a size penalty).

Read-write locks incur a substantial cost in both size and speed (especially under Windows), so you should use a read-write lock only if you can truly exploit the additional parallelism afforded by multiple readers and if a substantial amount of work is performed inside the critical region.

30.10 Threads

As described in Section 31.9, the server-side Ice run time by default creates a thread pool for you and automatically dispatches each incoming request in its own thread. As a result, you usually only need to worry about synchronization among threads to protect critical regions when you implement a server. However, you may wish to create threads of your own. For example, you might need a dedicated thread that responds to input from a user interface. And, if you have complex and long-running operations that can exploit parallelism, you might wish to use multiple threads for the implementation of that operation.

Ice provides a simple thread abstraction that permits you to write portable source code regardless of the native threading platform. This shields you from the native underlying thread APIs and guarantees uniform semantics regardless of your deployment platform.

30.10.1 The Thread Class

The basic thread abstraction in Ice is provided by two classes, `ThreadControl` and `Thread` (defined in `IceUtil/Thread.h`):

```
namespace IceUtil {

    class Time;

    class ThreadControl {
    public:
#ifdef _WIN32
        typedef DWORD ID;
#else
        typedef pthread_t ID;
#endif

        ThreadControl();
#ifdef _WIN32
        ThreadControl(HANDLE, DWORD);
#else
        ThreadControl(explicit pthread_t);
#endif
        ID id() const;

        void join();
        void detach();

        static void sleep(const Time&);
        static void yield();

        bool operator==(const ThreadControl&) const;
        bool operator!=(const ThreadControl&) const;

    };

    class Thread {
    public:
        virtual void run() = 0;
    };
};
```

```
ThreadControl start(size_t = 0);
ThreadControl getThreadControl() const;
bool isAlive() const;

bool operator==(const Thread&) const;
bool operator!=(const Thread&) const;
bool operator<(const Thread&) const;
};
typedef Handle<Thread> ThreadPtr;
}
```

The `Thread` class is an abstract base class with a pure virtual `run` method. To create a thread, you must specialize the `Thread` class and implement the `run` method (which becomes the starting stack frame for the new thread). The remaining member functions behave as follows:

- `start`

This member function starts a newly-created thread (that is, calls the `run` method).

The optional parameter specifies a stack size (in bytes) for the thread. The default value of zero creates the thread with a default stack size that is determined by the operating system.

The return value is a `ThreadControl` object for the new thread (see Section 30.10.4).

You can start a thread only once; calling `start` on an already-started thread raises `ThreadStartedException`.

- `getThreadControl`

This member function returns a thread control object for the thread on which it is invoked (see Section 30.10.4). Calling this method before calling `start` raises a `ThreadNotStartedException`.

- `id`

This method returns the underlying thread ID (DWORD for Windows and `pthread_t` for POSIX threads). This method is provided mainly for debugging purposes.⁴

4. `pthread_t` is, strictly-speaking, and opaque type, so you should not make any assumptions about what you can do with a thread ID.

- `isAlive`

This method returns false before a thread's `start` method has been called and after a thread's `run` method has completed; otherwise, while the thread is still running, it returns true. `isAlive` is useful to implement a non-blocking join:

```
ThreadPtr p = new MyThread();
// ...
while(p->isAlive()) {
    // Do something else...
}
t.join(); // Will not block
```

- `operator==`
`operator!=`
`operator<`

These member functions compare the in-memory address of two threads. They are provided so you can use sorted STL containers with `Thread` objects.

Note that `IceUtil` also defines the type `ThreadPtr`. This is the usual reference-counted smart pointer (see Section 6.14.6) to guarantee automatic clean-up: the `Thread` destructor calls `delete this` once its reference count drops to zero.

30.10.2 Implementing Threads

To illustrate how to implement threads, consider the following code fragment:

```
#include <IceUtil/Thread.h>
// ...

Queue q;

class ReaderThread : public IceUtil::Thread {
    virtual void run() {
        for (int i = 0; i < 100; ++i)
            cout << q.get() << endl;
    }
};

class WriterThread : public IceUtil::Thread {
    virtual void run() {
```

```
        for (int i = 0; i < 100; ++i)
            q.put(i);
    }
};
```

This code fragment defines two classes, `ReaderThread` and `WriterThread`, that inherit from `IceUtil::Thread`. Each class implements the pure virtual `run` method it inherits from its base class. For this simple example, a writer thread places the numbers from 1 to 100 into an instance of the thread-safe `Queue` class we defined in Section 30.8, and a reader thread retrieves 100 numbers from the queue and prints them to `stdout`.

Note that if `run` throws an exception, the thread is terminated as if it had exited normally, so a thread that is terminated by an exception that escapes the `run` member function can still be joined with.

30.10.3 Creating Threads

To create a new thread, we simply instantiate the thread and call its `start` method:

```
IceUtil::ThreadPtr t = new ReaderThread;
t->start();
// ...
```

Note that we assign the return value from `new` to a smart pointer of type `ThreadPtr`. This ensures that we do not suffer a memory leak:⁵

1. When the thread is created, its reference count is set to zero.
2. Prior to calling `run` (which is called by the `start` method), `start` increments the reference count of the thread to 1.
3. For each `ThreadPtr` for the thread, the reference count of the thread is incremented by 1, and for each `ThreadPtr` that is destroyed, the reference count is decremented by 1.
4. When `run` completes, `start` decrements the reference count again and then checks its value: if the value is zero at this point, the `Thread` object deallocates itself by calling `delete this`; if the value is non-zero at this point, there are other smart pointers that reference this `Thread` object and deletion happens when the last smart pointer goes out of scope.

5. `ThreadPtr` is another example of an RAII class [20].

Note that, for all this to work, you *must* allocate your Thread objects on the heap—stack-allocated Thread objects will result in deallocation errors:

```
ReaderThread thread;
IceUtil::ThreadPtr t = &thread; // Bad news!!!
```

This is wrong because the destructor of `t` will eventually call `delete`, which has undefined behavior for a stack-allocated object.

Similarly, you *must* use a `ThreadPtr` for an allocated thread. Do not attempt to explicitly delete a thread:

```
Thread* t = new ReaderThread();

// ...

delete t; // Disaster!
```

This will result in a double deallocation of the thread because the thread's destructor will call `delete this`.

It is legal for a thread to call `start` on itself from within its own constructor. However, if so, the thread must not be (very) short lived:

```
class ActiveObject : public Thread() {
public:
    ActiveObject() {
        start();
    }

    void done() {
        getThreadControl().join();
    }

    virtual void run() {
        // *Very* short lived...
    }
};
typedef Handle<ActiveObject> ActiveObjectPtr;

// ...

ActiveObjectPtr ao = new ActiveObject;
```

With this code, it is possible for `run` to complete before the assignment to the smart pointer `ao` completes; in that case, `start` will call `delete this`; before it returns and `ao` ends up deleting an already-deleted object. However, note that this problem can arise only if `run` is indeed *very* short-lived and moreover,

the scheduler allows the newly-created thread to run to completion before the assignment of the return value of `operator new` to `ao` takes place. This is highly unlikely to happen—if you are concerned about this scenario, do not call `start` from within a thread’s own constructor. That way, the smart pointer is assigned first, and the thread started second (as in the example on page 769), so the problem cannot arise.

30.10.4 The ThreadControl Class

The `start` method returns an object of type `ThreadControl` (see page 766). The member functions of `ThreadControl` behave as follows:

- `ThreadControl`

The default constructor returns a `ThreadControl` object that refers to the calling thread. This allows you to get a handle to the current (calling) thread even if you do not have saved a handle to that thread previously. For example:

```
IceUtil::ThreadControl self;    // Get handle to self
cout << self.id() << endl;    // Print thread ID
```

This example also explains why we have two classes, `Thread` and `ThreadControl`: without a separate `ThreadControl`, it would not be possible to obtain a handle to an arbitrary thread. (Note that this code works even if the calling thread was not created by the Ice run time; for example, you can create a `ThreadControl` object for a thread that was created by the operating system.)

The (implicit) copy constructor and assignment operator create a `ThreadControl` object that refers to the same underlying thread as the source `ThreadControl` object.

Note that the constructor is overloaded. For Windows, the signature is

```
ThreadControl (HANDLE, DWORD);
```

For UNIX, the signature is

```
ThreadControl (pthread_t);
```

These constructors allow you to create a `ThreadControl` object for the specified thread.

- `join`

This method suspends the calling thread until the thread on which `join` is called has terminated. For example:

```
IceUtil::ThreadPtr t = new ReaderThread; // Create a thread
IceUtil::ThreadControl tc = t->start(); // Start it
tc.join(); // Wait for it
```

If the reader thread has finished by the time the creating thread calls `join`, the call to `join` returns immediately; otherwise, the creating thread is suspended until the reader thread terminates.

Note that the `join` method of a thread must be called from only one other thread, that is, only one thread can wait for another thread to terminate.

Calling `join` on a thread from more than one other thread has undefined behavior.

Calling `join` on a thread that was previously joined with or calling `join` on a detached thread has undefined behavior.

- `detach`

This method detaches a thread. Once a thread is detached, it cannot be joined with.

Calling `detach` on an already detached thread, or calling `detach` on a thread that was previously joined with has undefined behavior.

Note that, if you have detached a thread, you must ensure that the detached thread has terminated before your program leaves its `main` function. This means that, because detached threads cannot be joined with, they must have a life time that is shorter than that of the main thread.

- `sleep`

This method suspends the calling thread for the amount of time specified by the `Time` parameter (see Section 30.7).

- `yield`

This method causes the calling thread to relinquish the CPU, allowing another thread to run.

- `operator==`
`operator!=`

These operators compare thread IDs. (Note that `operator<` is *not* provided because it cannot be implemented portably.) These operators yield meaningful results only for threads that have not been detached or joined with.

As for all the synchronization primitives, you must adhere to a few rules when using threads to avoid undefined behavior:

- Do not join with or detach a thread that you have not created yourself.

- For every thread you create, you must either join with that thread exactly once or detach it exactly once; failure to do so may cause resource leaks.
- Do not call `join` on a thread from more than one other thread.
- Do not leave `main` until all other threads you have created have terminated.
- Do not leave `main` until after you have destroyed all `Ice::Communicator` objects you have created (or use the `Ice::Application` class—see Section 8.3.1 on page 257)).
- A common mistake is to call `yield` from within a critical region. Doing so is usually pointless because the call to `yield` will look for another thread that can be run but, when that thread is run, it will most likely try to enter the critical region that is held by the yielding thread and go to sleep again. At best, this achieves nothing and, at worst, it causes many additional context switches for no gain.

If you call `yield`, do so only in circumstances where there is at least a fair chance that another thread will actually be able to run and do something useful.

30.10.5 A Small Example

Following is a small example that uses the `Queue` class we defined in Section 30.8. We create five writer and five reader threads. The writer threads each deposit 100 numbers into the queue, and the reader threads each retrieve 100 numbers and print them to `stdout`:

```
#include <vector>
#include <IceUtil/Thread.h>
// ...

Queue q;

class ReaderThread : public IceUtil::Thread {
    virtual void run() {
        for (int i = 0; i < 100; ++i)
            cout << q.get() << endl;
    }
};

class WriterThread : public IceUtil::Thread {
    virtual void run() {
        for (int i = 0; i < 100; ++i)
            q.put(i);
    }
};
```

```
    }  
};  
  
int  
main()  
{  
    vector<IceUtil::ThreadControl> threads;  
    int i;  
  
    // Create five reader threads and start them  
    //  
    for (i = 0; i < 5; ++i) {  
        IceUtil::ThreadPtr t = new ReaderThread;  
        threads.push_back(t->start());  
    }  
  
    // Create five writer threads and start them  
    //  
    for (i = 0; i < 5; ++i) {  
        IceUtil::ThreadPtr t = new WriterThread;  
        threads.push_back(t->start());  
    }  
  
    // Wait for all threads to finish  
    //  
    for (vector<IceUtil::ThreadControl>::iterator i  
        = threads.begin(); i != threads.end(); ++i) {  
        i->join();  
    }  
}
```

The code uses the `threads` variable, of type `vector<IceUtil::ThreadControl>` to keep track of the created threads. The code creates five reader and five writer threads, storing the `ThreadControl` object for each thread in the `threads` vector. Once all the threads are created and running, the code joins with each thread before returning from `main`.

Note that you *must not* leave `main` without first joining with the threads you have created: many threading libraries crash if you return from `main` with other threads still running. (This is also the reason why you must not terminate a program without first calling `Communicator::destroy` (see page 256); the `destroy` implementation joins with all outstanding threads before it returns.)

30.11 Portable Signal Handling

The `IceUtil::CtrlHandler` class provides a portable mechanism to handle Ctrl+C and similar signals sent to a C++ process. On Windows, `IceUtil::CtrlHandler` is a wrapper for `SetConsoleCtrlHandler`; on POSIX platforms, it handles `SIGHUP`, `SIGTERM` and `SIGINT` with a dedicated thread that waits for these signals using `sigwait`. Signals are handled by a callback function implemented and registered by the user. The callback is a simple function that takes an `int` (the signal number) and returns `void`; it should not throw any exception:

```
namespace IceUtil {

    typedef void (*CtrlHandlerCallback)(int);

    class CtrlHandler {
    public:
        CtrlHandler(CtrlHandlerCallback = 0);
        ~CtrlHandler();

        void setCallback(CtrlHandlerCallback);
        CtrlHandlerCallback getCallback() const;
    };
}
```

The member functions of `CtrlHandler` behave as follows:

- constructor

Constructs an instance with a callback function. Only one instance of `CtrlHandler` can exist in a process at a given moment in time. On POSIX platforms, the constructor masks `SIGHUP`, `SIGTERM` and `SIGINT`, then starts a thread that waits for these signals using `sigwait`. For signal masking to work properly, it is imperative that the `CtrlHandler` instance be created before starting any thread, and in particular before initializing an Ice communicator.

- destructor

Destroys the instance, after which the default signal processing behavior is restored on Windows (`TerminateProcess`). On POSIX platforms, the “`sigwait`” thread is cancelled and joined, but the signal mask remains unchanged, so subsequent signals are ignored.

- `setCallback`
Sets a new callback function.
- `getCallback`
Gets the current callback function.

It is legal specify a value of zero (0) for the callback function, in which case signals are caught and ignored until a non-zero callback function is set.

A typical use for `CtrlCHandler` is to shutdown a communicator in an Ice server (see Section 8.3.1).

30.12 Summary

This chapter explained the threading abstractions provided by Ice: mutexes, monitors, and threads. Using these APIs allows to make your code thread safe and to create threads of your own without having to use non-portable APIs that differ in syntax or semantics across different platforms: Ice not only provides a portable API but also guarantees that the semantics of the various functions are the same across different platforms. This makes it easier to create thread-safe applications and allows you to move your code between platforms with simple recompilation.

Chapter 31

The Ice Run Time in Detail

31.1 Introduction

Now that we have seen the basics of implementing clients and servers, it is time to look at the Ice run time in more detail. This chapter presents the server-side APIs of the Ice run time for synchronous, oneway, and datagram invocations in detail. (We cover the asynchronous interfaces in Chapter 32.)

Section 31.2 describes the functionality associated with Ice communicators, which are the main handle to the Ice run time. Sections 31.4 to 31.6 describe object adapters and the role they play for call dispatch, and show the relationship between proxies, Ice objects, servants, and object identities. Section 31.7 describes servant locators, which are a major mechanism in Ice for controlling the trade-off between performance and memory consumption. Section 31.8 describes the most common implementation techniques that are used by servers. We suggest that you read this section in detail because knowledge of these techniques is crucial to building systems that perform and scale well. Section 31.11 describes implicit transmission of parameters from client to server and Section 31.12 discusses connection timeouts. Sections 31.13 to 31.16 describe oneway, datagram, and batched invocations, and Sections 31.17 to 31.20 deal with location services, logging, statistics collection, and location transparency. Finally, Section 31.22 compares the Ice server-side run time with the corresponding CORBA approach.

31.2 Communicators

The main entry point to the Ice run time is represented by the local interface `Ice::Communicator`. An instance of `Ice::Communicator` is associated with a number of run-time resources:

- **Client-side thread pool**

The client-side thread pool (see Section 31.9) is used to process replies to asynchronous method invocations (AMI) (see Section 32.3), to avoid deadlocks in callbacks, and to process incoming requests on bidirectional connections (see Section 35.7).
- **Server-side thread pool**

Threads in this pool accept incoming connections and handle requests from clients. See Section 31.9 for more information.
- **Configuration properties**

Various aspects of the Ice run time can be configured via properties. Each communicator has its own set of such configuration properties (see Chapter 30).
- **Object factories**

In order to instantiate classes that are derived from a known base type, the communicator maintains a set of object factories that can instantiate the class on behalf of the Ice run time (see Section 6.14.5 and Section 10.14.4).
- **Logger object**

A logger object implements the `Ice::Logger` interface and determines how log messages that are produced by the Ice run time are handled (see Section 31.18).
- **Statistics object**

A statistics object implements the `Ice::Stats` interface and is informed about the amount of traffic (bytes sent and received) that is handled by a communicator (see Section 31.19).
- **Default router**

A router implements the `Ice::Router` interface. Routers are used by `Glacier2` (see Chapter 41) to implement the firewall functionality of Ice.

- Default locator

A locator is an object that resolves an object identity to a proxy. Locator objects are used to build location services, such as IceGrid (see Chapter 37).

- Plug-in manager

Plug-ins are objects that add features to a communicator. For example, IceSSL (see Chapter 40) is implemented as a plug-in. Each communicator has a plug-in manager that implements the `Ice::PluginManager` interface and provides access to the set of plug-ins for a communicator.

- Object adapters

Object adapters dispatch incoming requests and take care of passing each request to the correct servant.

Object adapters and objects that use different communicators are completely independent from each other. Specifically:

- Each communicator uses its own thread pool. This means that if, for example, one communicator runs out of threads for incoming requests, only objects using that communicator are affected. Objects using other communicators have their own thread pool and are therefore unaffected.
- Collocated invocations across different communicators are not optimized, whereas collocated invocations using the same communicator bypass much of the overhead of call dispatch.

Typically, servers use only a single communicator but, occasionally, multiple communicators can be useful. For example, IceBox (see Chapter 42) uses a separate communicator for each Ice service it loads to ensure that different services cannot interfere with each other. Multiple communicators are also useful to avoid thread starvation: if one service runs out of threads, this leaves the remaining services unaffected.

The interface of the communicator is defined in Slice. Part of this interface looks as follows:

```
module Ice {
    local interface Communicator {
        nonmutating string proxyToString(Object* obj);
        nonmutating Object* stringToProxy(string str);
        nonmutating Identity stringToIdentity(string str);
        nonmutating string identityToString(Identity id);
        ObjectAdapter createObjectAdapter(string name);
        ObjectAdapter createObjectAdapterWithEndpoints(
            string name,
```

```

        string endpoints);

        void shutdown();
        void waitForShutdown();
        void destroy();
        // ...
    };
    // ...
};

```

The communicator offers a number of operations:

- `proxyToString`
`stringToProxy`

These operations allow you to convert a proxy into its stringified representation and vice versa.

Instead of calling `proxyToString` on the communicator, you can also use the `ice_toString` operation on a proxy to stringify it (see Section 31.10.1).

However, you can only stringify non-null proxies that way—to stringify a null proxy, you must use `proxyToString`. (The stringified representation of a null proxy is the empty string.)

- `identityToString`
`stringToIdentity`

These operations allow you to convert an identity to a string and vice versa (see Section 31.5).

- `createObjectAdapter`
`createObjectAdapterWithEndpoints`

These operations create a new object adapter. Each object adapter is associated with zero or more transport endpoints.

Typically, an object adapter has a single transport endpoint. However, an object adapter can also offer multiple endpoints. If so, these endpoints each lead to the same set of objects and represent alternative means of accessing these objects. This is useful, for example, if a server is behind a firewall but must offer access to its objects to both internal and external clients; by binding the adapter to both the internal and external interfaces, the objects implemented in the server can be accessed via either interface.

An object adapter also can have no endpoint at all. In that case, the adapter can only be reached via collocated invocations originating from the same communicator as is used by the adapter.

Whereas `createObjectAdapter` determines which endpoints to bind itself to from configuration information (see Chapter 37), `createObjectAdapter-`

`WithEndpoints` allows you to specify the transport endpoints for the new adapter. Typically, you should use `createObjectAdapter` in preference to `createObjectAdapterWithEndpoints`. Doing so keeps transport-specific information, such as host names and port numbers, out of the source code and allows you to reconfigure the application by changing a property (and so avoid recompilation when a transport endpoint needs to be changed).

- `shutdown`

This operation shuts down the server side of the Ice run time:

- Operation invocations that are in progress at the time `shutdown` is called are allowed to complete normally. `shutdown` does *not* wait for these operations to complete; when `shutdown` returns, you know that no new incoming requests will be dispatched, but operations that were already in progress at the time you called `shutdown` may still be running. You can wait for still executing operations to complete by calling `waitForShutdown`.
- Operation invocations that arrive after the server has called `shutdown` either fail with a `ConnectFailedException` or are transparently redirected to a new instance of the server (see Chapter 37).
- Note that `shutdown` initiates deactivation of all object adapters associated with the communicator, so attempts to use an adapter once `shutdown` has completed raise an `ObjectAdapterDeactivatedException`.

- `waitForShutdown`

This operation suspends the calling thread until the communicator has shutdown (that is, until no more operations are executing in the server). This allows you to wait until the server is idle before you destroy the communicator.

- `destroy`

This operation destroys the communicator and all its associated resources, such as threads, communication endpoints, and memory resources. Once you have destroyed the communicator (and therefore destroyed the run time for that communicator), you must not call any other Ice operation (other than to create another communicator).

It is imperative that you call `destroy` before you leave the `main` function of your program. Failure to do so results in undefined behavior.

Calling `destroy` before leaving `main` is necessary because `destroy` waits for all running threads to terminate before it returns. If you leave `main` without calling `destroy`, you will leave `main` with other threads still running; many

threading packages do not allow you to do this and end up crashing your program.

If you call `destroy` without calling `shutdown`, the call waits for all executing operation invocations to complete before it returns (that is, the implementation of `destroy` implicitly calls `shutdown` followed by `waitForShutdown`). `shutdown` (and, therefore, `destroy`) deactivates all object adapters that are associated with the communicator.

On the client side, calling `shutdown` while operations are still executing causes those operations to terminate with a `CommunicatorDestroyedException`.

31.3 Communicator Initialization

During the creation of a communicator, the Ice run time initializes a number of features that affect the communicator's operation. Once set, these features remain in effect for the life time of the communicator, that is, you cannot change these features after you have created a communicator. Therefore, if you want to customize these features, you must do so when you create the communicator.

The following features can be customized at communicator creation time:

- the property set (see Chapter 30)
- the `Logger` interface (see Section 31.18)
- the `Stats` interface (see Section 31.19)
- the default context (see Section 31.11)
- the narrow and wide string converters (C++ only, see page 897)
- the thread notification hook (see page 857)

To establish these features, you initialize a structure or class of type `InitializationData` with the relevant settings. For C++ the structure is defined as follows:

```
namespace Ice {  
    struct InitializationData {  
        PropertiesPtr properties;  
        LoggerPtr logger;  
        StatsPtr stats;  
        Context defaultContext;  
        StringConverterPtr stringConverter;  
    };  
};
```

```

        WstringConverterPtr wstringConverter;
        ThreadNotificationPtr threadHook;
    };
}

```

For languages other than C++, `InitializationData` is a class with all data members public. (The string converter fields are missing for these languages.)

For C++, `Ice::initialize` is overloaded as follows:

```

namespace Ice {
    CommunicatorPtr initialize(
        const InitializationData& = InitializationData());
    CommunicatorPtr initialize(int&, char*[],
        const InitializationData& = InitializationData());
}

```

The version of `initialize` that accepts an `argc/argv` pair looks for Ice-specific command-line options and removes them from the argument vector, as described on page 256. The version without an `argc/argv` pair is useful if you want to prevent property settings for a program to be changed from the command line (see Section 30.8).

To set a feature, you set the corresponding field in the `InitializationData` structure and pass the structure to `initialize`. For example, to establish a custom logger of type `MyLogger`, you can use:

```

Ice::InitializationData id;
id.logger = new MyLoggerI();
Ice::CommunicatorPtr ic = Ice::initialize(argc, argv, id);

```

For Java, C#, and Visual Basic, `Ice.Util.initialize` is overloaded similarly (as is `Ice.initialize` for Python and `Ice::initialize` for Ruby), so you can pass an `InitializationData` instance either with or without an argument vector. The version of `initialize` without an argument does *not* look for a configuration in the `ICE_CONFIG` environment variable. (See also Section 30.6.)

31.4 Object Adapters

A communicator contains one or more object adapters. An object adapter sits at the boundary between the Ice run time and the server application code and has a number of responsibilities:

- It maps Ice objects to servants for incoming requests and dispatches the requests to the application code in each servant (that is, an object adapter implements an up-call interface that connects the Ice run time and the application code in the server).
- It assists in life cycle operations so Ice objects and servants can be created and existing destroyed without race conditions.
- It provides one or more transport endpoints. Clients access the Ice objects provided by the adapter via those endpoints. (It is also possible to create an object adapter without endpoints. In this case the adapter is used for bidirectional callbacks—see Section 35.7.)

Each object adapter has one or more servants that incarnate Ice objects, as well as one or more transport endpoints. If an object adapter has more than one endpoint, all servants registered with that adapter respond to incoming requests on any of the endpoints. In other words, if an object adapter has multiple transport endpoints, those endpoints represent alternative communication paths to the same set of objects (for example, via different transports).

Each object adapter belongs to exactly one communicator (but a single communicator can have many object adapters). Each object adapter has a name that distinguishes it from all other object adapters in the same communicator.

Each object adapter can optionally have its own thread pool, enabled via the `<adapter-name>.ThreadPool.Size` property (see Section 31.9.1). If so, client invocations for that adapter are dispatched in a thread taken from the adapter's thread pool instead of using a thread from the communicator's server thread pool.

31.4.1 The Active Servant Map

Each object adapter maintains a data structure known as the *active servant map*. The active servant map (or *ASM*, for short) is a lookup table that maps object identities to servants: for C++, the lookup value is a smart pointer to the corresponding servant's location in memory; for Java and C#, the lookup value is a reference to the servant. When a client sends an operation invocation to the server, the request is targeted at a specific transport endpoint. Implicitly, the transport endpoint identifies the object adapter that is the target of the request (because no two object adapters can be bound to the same endpoint). The proxy via which the client sends its request contains the object identity for the corresponding object, and the client-side run time sends this object identity over the wire with the invocation. In turn,

the object adapter uses that object identity to look in its ASM for the correct servant to dispatch the call to, as shown in Figure 31.1.

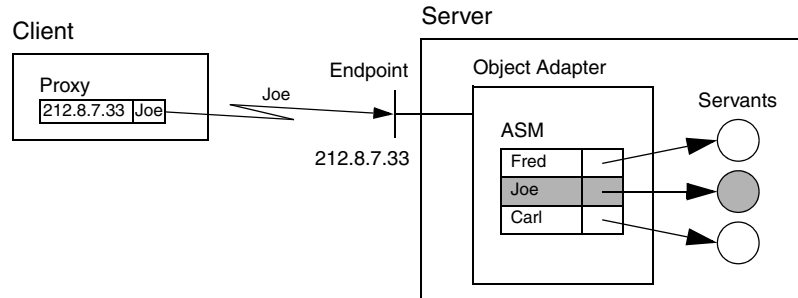

Figure 31.1. Binding a request to the correct servant.

The process of associating a request via a proxy to the correct servant is known as *binding*. The scenario depicted in Figure 31.1 shows direct binding, in which the transport endpoint is embedded in the proxy. Ice also supports an indirect binding mode, in which the correct transport endpoints are provided by the IceGrid service (see Chapter 37 for details).

If a client request contains an object identity for which there is no entry in the adapter’s ASM, the adapter returns an `ObjectNotExistException` to the client (unless you use a servant locator—see Section 31.7).

31.4.2 Servants

As mentioned in Section 2.2.2, servants are the physical manifestation of an Ice object, that is, they are entities that are implemented in a concrete programming language and instantiated in the server’s address space. Servants provide the server-side behavior for operation invocations sent by clients.

The same servant can be registered with one or more object adapters.

31.4.3 Object Adapter Interface

Object adapters are local interfaces:

```
module Ice {
    local interface ObjectAdapter {
        string getName();
        Communicator getCommunicator();
    };
};
```

```

        // ...
    };
};

```

The operations behave as follows:

- The `getName` operation returns the name of the adapter as passed to `Communicator::createObjectAdapter` or `Communicator::createObjectAdapterWithEndpoints`.
- The `getCommunicator` operation returns the communicator that was used to create the adapter.

Note that there are other operations in the `ObjectAdapter` interface; we will explore these throughout the remainder of this chapter.

31.4.4 Servant Activation and Deactivation

The term *servant activation* refers to making the presence of a servant for a particular Ice object known to the Ice run time. Activating a servant adds an entry to the active servant map shown in Figure 31.1. Another way of looking at servant activation is to think of it as creating a link between the identity of an Ice object and the corresponding programming-language servant that handles requests for that Ice object. Once the Ice run time has knowledge of this link, it can dispatch incoming requests to the correct servant. Without this link, that is, without a corresponding entry in the ASM, an incoming request for the identity results in an `ObjectNotExistException`. While a servant is activated, it is said to *incarnate* the corresponding Ice object.

The inverse operation is known as *servant deactivation*. Deactivating a servant removes an entry for a particular identity from the ASM. Thereafter, incoming requests for that identity are no longer dispatched to the servant and result in an `ObjectNotExistException`.

The object adapter offers a number of operations to manage servant activation and deactivation:

```

module Ice {
    local interface ObjectAdapter {
        // ...

        Object* add(Object servant, Identity id);
        Object* addWithUUID(Object servant);
        Object remove(Identity id);
    };
};

```



```
        // ...  
    };  
};
```

The operations behave as follows:

- `add`

The `add` operation adds a servant with the given identity to the ASM. Requests are dispatched to that servant as soon as `add` is called. The return value is the proxy for the Ice object incarnated by that servant. The proxy embeds the identity passed to `add`.

You cannot call `add` with the same identity more than once: attempts to add an already existing identity to the ASM result in an `AlreadyRegisteredException`. (It does not make sense to add two servants with the same identity because that would make it ambiguous as to which servant should handle incoming requests for that identity.)

Note that it is possible to activate the same servant multiple times with different identities. In that case, the same single servant incarnates multiple Ice objects. We explore the ramifications of this in more detail in Section 31.8.2.

- `addWithUUID`

The `addWithUUID` operation behaves the same way as the `add` operation but does not require you to supply an identity for the servant. Instead, `addWithUUID` generates a UUID (see [14]) as the identity for the corresponding Ice object. You can retrieve the generated identity by calling the `ice_getIdentity` operation on the returned proxy. `addWithUUID` is useful to create identities for temporary objects, such as short-lived session objects. (You can also use `addWithUUID` for persistent objects that do not have a natural identity, as we have done for the filesystem application.)

- `remove`

The `remove` operation breaks the association between an identity and its servant by removing the corresponding entry from the ASM; it returns a smart pointer to the removed servant.

Once the servant is deactivated, new incoming requests for the removed identity result in an `ObjectNotExistException`. Requests that are executing inside the servant at the time `remove` is called are allowed to complete normally. Once the last request for the servant is complete, the object adapter drops its reference (or smart pointer, for C++) to the servant. At that point, the

servant becomes available for garbage collection (or is destroyed, for C++), provided that you do not hold references or smart pointers to the servant elsewhere. The net effect is that a deactivated servant is destroyed once it becomes idle.

Deactivating an object adapter (see Section 31.4.5) implicitly calls `remove` on its active servants.

31.4.5 Adapter States

An object adapter has a number of processing states:

- holding

In this state, any incoming requests for the adapter are held, that is, not dispatched to servants.

For TCP/IP (and other stream-oriented protocols), the server-side run time stops reading from the corresponding transport endpoint while the adapter is in the holding state. In addition, it also does not accept incoming connection requests from clients. This means that if a client sends a request to an adapter that is in the holding state, the client eventually receives a `TimeoutException` or `ConnectTimeoutException` (unless the adapter is placed into the active state before the timer expires).

For UDP, client requests that arrive at an adapter that is in the holding state are thrown away.

Immediately after creation of an adapter, the adapter is in the holding state. This means that requests are not dispatched until you place the adapter into the active state.

- active

In this state, the adapter accepts incoming requests and dispatches them to servants. A newly-created adapter is initially in the holding state. The adapter begins dispatching requests as soon as you place it into the active state.

You can transition between the active and the holding state as many times as you wish.

- inactive

In this state, the adapter has conceptually been destroyed (or is in the process of being destroyed). Deactivating an adapter destroys all transport endpoints that are associated with the adapter. Requests that are executing at the time the adapter is placed into the inactive state are allowed to complete, but no new

requests are accepted. (New requests are rejected with an exception). Once an adapter has been deactivated, you can reactivate it again. Any attempt to use a deactivated object adapter results in an `ObjectAdapterDeactivatedException`.

The `ObjectAdapter` interface offers operations that allow you to change the adapter state, as well as to wait for a state change to be complete:

```
module Ice {
    local interface ObjectAdapter {
        // ...

        void activate();
        void hold();
        void waitForHold();
        void deactivate();
        void waitForDeactivate();

        // ...
    };
};
```

The operations behave as follows:

- `activate`

The `activate` operation places the adapter into the active state. Activating an adapter that is already active has no effect. The Ice run time starts dispatching requests to servants for the adapter as soon as `activate` is called.

- `hold`

The `hold` operation places the adapter into the holding state. Requests that arrive after calling `hold` are held as detailed on page 788. Requests that are in progress at the time `hold` is called are allowed to complete normally. Note that `hold` returns immediately without waiting for currently executing requests to complete.

- `waitForHold`

The `waitForHold` operation suspends the calling thread until the adapter has completed its transition to the holding state, that is, until all currently executing requests have finished. You can call `waitForHold` from multiple threads, and you can call `waitForHold` while the adapter is in the active state. If you call `waitForHold` on an adapter that is already in the holding state, `waitForHold` returns immediately.

- `deactivate`

The `deactivate` operation initiates deactivation of the adapter: requests that arrive after calling `deactivate` are rejected, but currently executing requests are allowed to complete, and any servants associated with the adapter are destroyed once they become idle. Once all requests have completed, the adapter enters the inactive state. Note that `deactivate` returns immediately without waiting for the currently executing requests to complete. Any attempt to use a deactivated object adapter results in an `ObjectAdapterDeactivatedException`.

- `waitForDeactivate`

The `waitForDeactivate` operation suspends the calling thread until the adapter has completed its transition to the inactive state, that is, until all currently executing requests have completed, all transport endpoints have been closed, and all associated servants have been destroyed. You can call `waitForDeactivate` from multiple threads, and you can call `waitForDeactivate` while the adapter is in the active or holding state. Calling `waitForDeactivate` on an adapter that is in the inactive state does nothing and returns immediately.

Note that, after calling `deactivate`, you *must* call `waitForDeactivate`; this is necessary because `waitForDeactivate` deallocates internal resources.

Placing an adapter into the holding state is useful, for example, if you need to make state changes in the server that require the server (or a group of servants) to be idle. For example, you could place the implementation of your servants into a dynamic library and upgrade the implementation by loading a newer version of the library at run time without having to shut down the server.

Similarly, waiting for an adapter to complete its transition to the inactive state is useful if your server needs to perform some final clean-up work that cannot be carried out until all executing request have completed.

Note that you can create an object adapter with the same name as a previous object adapter, but only once `waitForDeactivate` on the previous adapter has completed.

31.4.6 Endpoints

An object adapter maintains two sets of transport endpoints. One set identifies the network interfaces on which the adapter listens for new connections, and the other set is embedded in proxies created by the adapter and used by clients to communicate with it. We will refer to these sets of endpoints as the *physical endpoints* and

the *published endpoints*, respectively. In most cases these sets are identical, but there are situations when they must be configured independently.

Physical Endpoints

An object adapter's physical endpoints identify the network interfaces on which it receives requests from clients. These endpoints are configured via the `name.Endpoints` property, or they can be specified explicitly when the adapter is created using the operation `createObjectAdapterWithEndpoints` (see Section 31.2). The endpoint syntax is described in detail in Appendix D, however an endpoint generally consists of a transport protocol followed by an optional hostname and port.

If a hostname is specified, the object adapter listens only on the network interface associated with that hostname. If no hostname is specified but the property `Ice.Default.Host` is defined, the object adapter uses the property's value as the hostname. Finally, if a hostname is not specified, and the property `Ice.Default.Host` is undefined, the object adapter listens on all available network interfaces, including the loopback interface. You may also force the object adapter to listen on all interfaces by using one of the hostnames `0.0.0.0` or `*`.

If you want an adapter to accept requests on certain network interfaces, you must specify a separate endpoint for each interface. For example, the following property configures a single endpoint for the adapter named `MyAdapter`:

```
MyAdapter.Endpoints=tcp -h 10.0.1.1 -p 9999
```

This endpoint causes the adapter to accept requests on the network interface associated with the IP address `10.0.1.1` at port `9999`. Note however that this adapter configuration does not accept requests on the loopback interface (the one associated with address `127.0.0.1`). If both addresses must be supported, then both must be specified explicitly, as shown below:

```
MyAdapter.Endpoints=tcp -h 10.0.1.1 -p 9999:tcp -h 127.0.0.1 -p 9999
```

If these are the only two network interfaces available on the host, then a simpler configuration omits the hostname altogether, causing the object adapter to listen on both interfaces automatically:

```
MyAdapter.Endpoints=tcp -p 9999
```

If you want to make your configuration more explicit, you can use one of the special hostnames:

```
MyAdapter.Endpoints=tcp -h * -p 9999
```

Another advantage to this configuration is that it ensures the object adapter always listens on all interfaces, even if a definition for `Ice.Default.Host` is later added to your configuration. Without an explicit hostname, the addition of `Ice.Default.Host` could potentially change the interfaces on which the adapter is listening.

Careful consideration must also be given to the selection of a port for an endpoint. If no port is specified, the adapter uses a port that is selected (essentially at random) by the operating system, meaning the adapter will likely be using a different port each time the server is restarted. Whether that behavior is desirable depends on the application, but in many applications a client has a proxy containing the adapter's endpoint and expects that proxy to remain valid indefinitely. Therefore, an endpoint generally should contain a fixed port to ensure that the adapter is always listening at the same port.

However, there are certain situations where a fixed port is not required. For example, an adapter whose servants are transient does not need a fixed port, because the proxies for those objects are not expected to remain valid past the lifetime of the server process. Similarly, a server using indirect binding via IceGrid (see Chapter 37) does not need a fixed port because its port is never published.

Published Endpoints

An object adapter publishes its endpoints in the proxies it creates, but it is not always appropriate to publish the adapter's physical endpoints in a proxy. For example, suppose a server is running on a host in a private network, protected from the public network by a firewall that can forward network traffic to the server. The adapter's physical endpoints must use the private network's address scheme, but a client in the public network would be unable to use those endpoints if they were published in a proxy. In this scenario, the adapter must publish endpoints in its proxies that direct the client to the firewall instead.

The published endpoints are configured using the adapter property `name.PublishedEndpoints`. If this property is not defined, the adapter publishes its physical endpoints by default, with one exception: endpoints for the loopback address (`127.0.0.1`) are not published unless the loopback interface is the only interface, or `127.0.0.1` (or `loopback`) is explicitly listed as an endpoint with `-h` option. Otherwise, to force the inclusion of loopback endpoints when they would normally be excluded, you must define `name.PublishedEndpoints` explicitly.

As an example, the properties below configure the adapter named `MyAdapter` with physical and published endpoints:

```
MyAdapter.Endpoints=tcp -h 10.0.1.1 -p 9999
MyAdapter.PublishedEndpoints=tcp -h corpfw -p 25000
```

This example assumes that clients connecting to host `corpfw` at port 25000 are forwarded to the adapter's endpoint in the private network.

Another use case of published endpoints is for replicated servers. Suppose we have two instances of a stateless server running on separate hosts in order to distribute the load between them. We can supply the client with a bootstrap proxy containing the endpoints of both servers, and the Ice run time in the client will select one of the servers at random when a connection is established. However, should the client invoke an operation on a server that returns a proxy for another object, that proxy would normally contain only the endpoint of the server that created it. Invocations on the new proxy are always directed at the same server, reducing the opportunity for load balancing.

We can alleviate this situation by configuring the adapters to publish the endpoints of both servers. For example, here is a configuration for the server on host `Sun1`:

```
MyAdapter.Endpoints=tcp -h Sun1 -p 9999
MyAdapter.PublishedEndpoints=tcp -h Sun1 -p 9999:tcp -h Sun2 -p 9999
```

Similarly, the configuration for host `Sun2` retains the same published endpoints:

```
MyAdapter.Endpoints=tcp -h Sun2 -p 9999
MyAdapter.PublishedEndpoints=tcp -h Sun1 -p 9999:tcp -h Sun2 -p 9999
```

Routers

If an object adapter is configured with a router, the adapter's published endpoints are augmented to reflect the router. See Chapter 41 for more information on configuring an adapter with a router.

31.4.7 Creating Proxies

Although the servant activation operations described in Section 31.4.4 return proxies, the life cycle of proxies is completely independent from servants (see XREF). The `ObjectAdapter` interface provides several operations for creating a proxy, regardless of whether a servant is currently activated for the object's identity:

```
module Ice {
    local interface ObjectAdapter {
        // ...
    }
}
```

```
        Object* createProxy(Identity id);
        Object* createDirectProxy(Identity id);
        Object* createIndirectProxy(Identity id);
        Object* createReverseProxy(Identity id);

        // ...
    };
};
```

The `createReverseProxy` operation is provided for use by specialized services such as routers and should not be used by applications. The remaining operations are described below:

- `createProxy`

The `createProxy` operation returns a new proxy for the object with the given identity. The adapter's configuration determines whether the return value is a direct proxy or an indirect proxy (see Section 2.2.2). If the adapter is configured with an adapter id (see Section 31.17.5), the operation returns an indirect proxy that refers to the adapter id. If the adapter is also configured with a replica group id, the operation returns an indirect proxy that refers to the replica group id. Otherwise, if an adapter id is not defined, `createProxy` returns a direct proxy containing the adapter's published endpoints (see Section 31.4.6).

- `createDirectProxy`

The `createDirectProxy` operation returns a direct proxy containing the adapter's published endpoints (see Section 31.4.6).

- `createIndirectProxy`

The `createIndirectProxy` operation returns an indirect proxy. If the adapter is configured with an adapter id, the returned proxy refers to that adapter id. Otherwise, the proxy refers only to the object's identity (see page 13).

In contrast to `createProxy`, `createIndirectProxy` does not use the replica group id. Therefore, the returned proxy always refers to a specific replica.

31.5 Object Identity

Each Ice object has an object identity defined as follows:

```
module Ice {
    struct Identity {
        string name;
        string category;
    };
};
```

As you can see, an object identity consists of a pair of strings, a name and a category. The complete object identity is the combination of name and category, that is, for two identities to be equal, both name and category must be the same. The category member is usually the empty string, unless you are using servant locators (see Section 31.7).¹

If name is an empty string, category must be the empty string as well. (An identity with an empty name and a non-empty category is illegal.) If a proxy contains an identity in which name is empty, Ice interprets that proxy as a null proxy.

Object identities can be represented as strings; the category part appears first and is followed by the name; the two components are separated by a / character, for example:

```
Factory/File
```

In this example, Factory is the category, and File is the name. If the name or category member themselves contain a / character, the stringified representation escapes the / character with a \, for example:

```
Factories\Factory/Node\File
```

In this example, the category member is Factories/Factory and the name member is Node/File.

31.5.1 Syntax for Stringified Identities

You rarely need to write identities as strings because, typically, your code will be using `identityToString` and `stringToIdentity` (see Section 31.5.2), or simply deal with proxies instead of identities. However, on occasion, you will need to use stringified identities in configuration files. If the identities happen to contain meta-characters (such as a slash or backslash), or characters outside the printable

1. Glacier2 (see Chapter 41) also uses the category member for filtering.

ASCII range, these characters must be escaped in the stringified representation. Here are rules that the Ice run time applies when parsing a stringified identity:

1. The parser scans the stringified identity for an un-escaped slash character (/). If such a slash character can be found, the substrings to the left and right of the slash are parsed as the category and name members of the identity, respectively; if no such slash character can be found, the entire string is parsed as the name member of the identity, and the category member is the empty string.
2. Each of the category (if present) and name substrings is parsed according to the following rules:
 1. All characters in the string must be in the ASCII range 32 (space) to 126 (~); characters outside this range cause the parse to fail.
 2. Any character that is not part of an escape sequence is treated as that character.
 3. The parser recognizes the following escape sequences and replaces them with their equivalent character:
 - `\\` (backslash)
 - `\'` (single quote)
 - `\"` (double quote)
 - `\b` (space)
 - `\f` (form feed)
 - `\n` (new line)
 - `\r` (carriage return)
 - `\t` (tab)
 4. An escape sequence of the form `\o`, `\oo`, or `\ooo` (where `o` is a digit in the range 0 to 7) is replaced with the the ASCII character with the corresponding octal value. Parsing for octal digits allows for at most three consecutive digits, so the string `\0763` is interpreted as the character with octal value 76 (>) followed by the character 3. Parsing for octal digits terminates as soon as it encounters a character that is not in the range 0 to 7, so `\7x` is the character with octal value 7 (bell) followed by the character `x`. Octal escape sequences must be in the range 0 to 255 (octal 000 to 377); escape sequences outside this range cause a parsing error. For example, `\539` is an illegal escape sequence.
 5. If a character follows a backslash, but is not part of a recognized escape sequence, the backslash is ignored, so `\x` is the character `x`.

31.5.2 Helper Functions

To make conversion of identities to and from strings easier, the `Communicator` interface provides appropriate conversion functions:

```
local interface Communicator {
    string identityToString(Identity id);
    Identity stringToIdentity(string id);
};
```

For C++, the operations on the communicator are the only way to convert between identities and strings. For other languages, the conversion functions are provided as operations on the communicator as well but, in addition, the language mappings provide static utility functions. (The utility functions have the advantage that you can call them without holding a reference to the communicator.)²

For Java, the utility functions are in the `Ice.Util` class and are defined as:

```
package Ice;

public final class Util {
    public static String    identityToString(Identity id);
    public static Identity stringToIdentity(String s);
}
```

For C#, the utility functions are in the `Ice.Util` class and are defined as:

```
namespace Ice
{
    public sealed class Util
    {
        public static string    identityToString(Identity id);
        public static Identity stringToIdentity(string s);
    }
}
```

These functions correctly encode and decode characters that might otherwise cause problems (such as control characters or white space).

As mentioned on page 787, each entry in the ASM for an object adapter must be unique: you cannot add two servants with the same identity to the ASM.

2. For C++, the static utility functions are not provided due to the need to apply string conversions, and the string converters are registered on the communicator (see Section 31.21).

31.6 The Ice::Current Object

Up to now, we have tacitly ignored the trailing parameter of type `Ice::Current` that is passed to each skeleton operation on the server side. The `Current` object is defined as follows:

```
module Ice {
    local dictionary<string, string> Context;

    enum OperationMode { Normal, \Nonmutating, \Idempotent };

    local struct Current {
        ObjectAdapter    adapter;
        Connection        con;
        Identity          id;
        string            facet;
        string            operation;
        OperationMode    mode;
        Context           ctx;
        int               requestId;
    };
};
```

Note that the `Current` object provides access to information about the currently executing request to the implementation of an operation in the server:

- `adapter`
The `adapter` member provides access to the object adapter via which the request is being dispatched. In turn, the adapter provides access to its communicator (via the `getCommunicator` operation).
- `con`
The `con` member provides information about the connection over which this request was received (see Section 35.5.1).
- `id`
The `id` member provides the object identity for the current request (see Section 31.5).
- `facet`
The `facet` member provides access to the facet for the request (see Chapter 33).

- `operation`
The `operation` member contains the name of the operation that is being invoked. Note that the operation name may indicate one of the operations on `Ice::Object`, such as `ice_ping` or `ice_isA`. (`ice_isA` is invoked if a client performs a `checkedCast`.)
- `mode`
The `mode` member contains the invocation mode for the operation (`Normal`, `Idempotent`, or `Nonmutating`).
- `ctx`
The `ctx` member contains the current context for the invocation (see Section 31.11).
- `requestId`
The Ice protocol (see Chapter 34) uses request IDs to associate replies with their corresponding requests. The `requestId` member provides this ID. For oneway requests (which do not have replies), the request ID is 0. For collocated requests (which do not use the Ice protocol), the request ID is -1.

If you implement your server such that it uses a separate servant for each Ice object, the contents of the `Current` object are not particularly interesting. (You would most likely access the `Current` object to read the `adapter` member, for example, to activate or deactivate a servant.) However, as we will see in Section 31.7, the `Current` object is essential for more sophisticated (and more scalable) servant implementations.

31.7 Servant Locators

Using an adapter's ASM to map Ice objects to servants has a number of design implications:

- Each Ice object is represented by a different servant.³
- All servants for all Ice objects are permanently in memory.

Using a separate servant for each Ice object in this fashion is common to many server implementations: the technique is simple to implement and provides a

3. It is possible to register a single servant with multiple identities. However, there is little point in doing so because a default servant (see Section 31.8.2) achieves the same thing.

natural mapping from Ice objects to servants. Typically, on start-up, the server instantiates a separate servant for each Ice object, activates each servant, and then calls `activate` on the object adapter to start the flow of requests.

There is nothing wrong with the above design, provided that two criteria are met:

1. The server has sufficient memory available to keep a separate servant instantiated for each Ice object at all times.
2. The time required to initialize all the servants on start-up is acceptable.

For many servers, neither criterion presents a problem: provided that the number of servants is small enough and that the servants can be initialized quickly, this is a perfectly acceptable design. However, the design does not scale well: the memory requirements of the server grow linearly with the number of Ice objects so, if the number of objects gets too large (or if each servant stores too much state), the server runs out of memory.

Ice uses *servant locators* to allow you to scale servers to larger numbers of objects.

31.7.1 Overview

In a nutshell, a servant locator is a local object that you implement and attach to an object adapter. Once an adapter has a servant locator, it consults its ASM to locate a servant for an incoming request as usual. If a servant for the request can be found in the ASM, the request is dispatched to that servant. However, if the ASM does not have an entry for the object identity of the request, the object adapter calls back into the servant locator to ask it to provide a servant for the request. The servant locator either

- instantiates a servant and passes it to the Ice run time, in which case the request is dispatched to that newly instantiated servant, or
- the servant locator indicates failure to locate a servant to the Ice run time, in which case the client receives an `ObjectNotExistException`.

This simple mechanism allows us to scale servers to provide access to an unlimited number of Ice objects: instead of instantiating a separate servant for each and every Ice object in existence, the server can instantiate servants for only a subset of Ice objects, namely those that are actually used by clients.

Servant locators are most commonly used by servers that provide access to databases: typically, the number of entries in the database is far larger than what

the server can hold in memory. Servant locators allow the server to only instantiate servants for those Ice objects that are actually used by clients.

Another common use for servant locators is in servers that are used for process control or network management: in that case, there is no database but, instead, there is a potentially very large number of devices or network elements that must be controlled via the server. Otherwise, this scenario is the same as for large databases: the number of Ice objects exceeds the number of servants that the server can hold in memory and, therefore, requires an approach that allows the number of instantiated servants to be less than the number of Ice objects.

31.7.2 Servant Locator Interface

A servant locator has the following interface:

```
module Ice {
    local interface ServantLocator {
        Object locate(    Current    curr,
                       out LocalObject cookie);

        void finished(    Current    curr,
                        Object      servant,
                        LocalObject cookie);

        void deactivate(string category);
    };
};
```

Note that `ServantLocator` is a local interface. To create an actual implementation of a servant locator, you must define a class that is derived from `Ice::ServantLocator` and provide implementations of the `locate`, `finished`, and `deactivate` operations. The Ice run time invokes the operations on your derived class as follows:

- `locate`

Whenever a request arrives for which no entry exists in the ASM, the Ice run time calls `locate`. The implementation of `locate` (which you provide as part of the derived class) is supposed to return a servant that can process the incoming request. Your implementation of `locate` can behave in three possible ways:

1. Instantiate and return a servant for the current request. In this case, the Ice run time dispatches the request to the newly instantiated servant.

2. Return null. In this case, the Ice run time raises an `ObjectNotExistException` in the client.
3. Throw an exception. In this case, the Ice run time propagates the thrown exception back to the client. (Keep in mind that all exceptions, apart from `ObjectNotExistException`, `OperationNotExistException`, and `FacetNotExistException`, are presented as `UnknownLocalException` to the client.)

The cookie out-parameter to `locate` allows you return a local object to the object adapter. The object adapter does not care about the contents of that object (and it is legal to return a null cookie). Instead, the Ice run time passes whatever cookie you return from `locate` back to you when it calls `finished`. This allows you to pass an arbitrary amount of state from `locate` to the corresponding call to `finished`.

- `finished`

If a call to `locate` has returned a servant to the Ice run time, the Ice run time dispatches the incoming request to the servant. Once the request is complete (that is, the operation being invoked has completed), the Ice run time calls `finished`, passing the servant whose operation has completed, the `Current` object for the request, and the cookie that was initially created by `locate`. This means that every call to `locate` is balanced by a corresponding call to `finished` (provided that `locate` actually returned a servant).

You cannot throw exceptions from `finished`—if you do, the Ice run time logs an error messages and (for connection-oriented transports) closes the connection to the client.

- `deactivate`

The `deactivate` operation allows a servant locator to clean up once it is no longer needed. (For example, the locator might close a database connection.) The Ice run time passes the category of the servant locator being deactivated to the `deactivate` operation.

The run time calls `deactivate` when the object adapter to which the servant locator is attached is deactivated. More precisely, `deactivate` is called when you call `waitForDeactivate` on the object adapter, or when you call

`waitForShutdown` on the communicator (or `destroy` on the communicator, which implicitly calls `waitForShutdown`).

Once the run time has called `deactivate`, it is guaranteed that no further calls to `locate` or `finished` can happen, that is, `deactivate` is called exactly once, after all operations dispatched via this servant locator have completed.

This also explains why `deactivate` is not called as part of `ObjectAdapter::deactivate`: `ObjectAdapter::deactivate` initiates deactivation and returns immediately, so it cannot call `ServantLocator::deactivate` directly, because there might still be outstanding requests dispatched via this servant locator that have to complete first—in turn, this would mean that either `ObjectAdapter::deactivate` could block (which it must not do) or that a call to `ServantLocator::deactivate` could be followed by one or more calls to `finished` (which must not happen either).

It is important to realize that the Ice run time does not “remember” the servant that is returned by a particular call to `locate`. Instead, the Ice run time simply dispatches an incoming request to the servant returned by `locate` and, once the request is complete, calls `finished`. In particular, if two requests for the same servant arrive more or less simultaneously, the Ice run time calls `locate` and `finished` once for each request. In other words, `locate` establishes the association between an object identity and a servant; that association is valid only for a single request and is never used by the Ice run time to dispatch a different request.

31.7.3 Threading Guarantees for Servant Locators

The Ice run time guarantees that every operation invocation that involves a servant locator is bracketed by calls to `locate` and `finished`, that is, every call to `locate` is balanced by a corresponding call to `finished` (assuming that the call to `locate` actually returned a servant, of course).

In addition, the Ice run time guarantees that `locate`, the operation, and `finished` are called by the same thread. This guarantee is important because it allows you to use `locate` and `finished` to implement thread-specific pre- and post-processing around operation invocations. (For example, you can start a transaction in `locate` and commit or roll back that transaction in `finished`, or you can acquire a lock in `locate` and release the lock in `finished`.⁴)

Note that, if you are using asynchronous method dispatch (see Chapter 32), the thread that starts a call is not necessarily the thread that finishes it. In that case,

`finished` is called by whatever thread executes the operation implementation, which is may be different thread than the one that called `locate`.

The Ice run time also guarantees that `deactivate` is called when you deactivate the object adapter to which the servant locator is attached. The `deactivate` call is made only once all operations that involved the servant locator are finished, that is, `deactivate` is guaranteed not to run concurrently with `locate` or `finished`, and is guaranteed to be the *last* call made to a servant locator.

Beyond this, the Ice run time provides no threading guarantees for servant locators. In particular:

- It is possible for invocations of `locate` to proceed concurrently (for the same object identity or for different object identities).
- It is possible for invocations of `finished` to proceed concurrently (for the same object identity or for different object identities).
- It is possible for invocations of `locate` and `finished` to proceed concurrently (for the same object identity or for different object identities).

These semantics allow you to extract the maximum amount of parallelism from your application code (because the Ice run time does not serialize invocations when serialization may not be necessary). Of course, this means that you must protect access to shared data from `locate` and `finished` with mutual exclusion primitives as necessary.

31.7.4 Servant Locator Registration

An object adapter does not automatically know when you create a servant locator. Instead, you must explicitly register servant locators with the object adapter:

```
module Ice {
    local interface ObjectAdapter {
        // ...

        void addServantLocator(ServantLocator locator,
                               string category);

        ServantLocator findServantLocator(string category);
    };
};
```

-
4. Both transactions and locks usually are thread-specific, that is, only the thread that started a transaction can commit it or roll it back, and only the thread that acquired a lock can release the lock.

```
        // ...  
    };  
};
```

As you can see, the object adapter allows you add and find servant locators. Note that, when you register a servant locator, you must provide an argument for the category parameter. The value of the category parameter controls which object identities the servant locator is responsible for: only object identities with a matching category member (see page 794) trigger a corresponding call to `locate`. An incoming request for which no explicit entry exists in the ASM and with a category for which no servant locator is registered returns an `ObjectNotExistException` to the client.

`addServantLocator` has the following semantics:

- You can register exactly one servant locator for a specific category. Attempts to call `addServantLocator` for the same category more than once raise an `AlreadyRegisteredException`.
- You can register different servant locators for different categories, or you can register the same single servant locator multiple times (each time for a different category). In the former case, the category is implicit in the servant locator instance that is called by the Ice run time; in the latter case, the implementation of `locate` can find out which category the incoming request is for by examining the object identity member of the `Current` object that is passed to `locate`.
- It is legal to register a servant locator for the empty category. Such a servant locator is known as a *default servant locator*: if a request comes in for which no entry exists in the ASM, and whose category does not match the category of any other registered servant locator, the Ice run time calls `locate` on the default servant locator.

Note that, once registered, you cannot change or remove the servant locator for a category. The life cycle of the servant locators for an object adapter ends with the life cycle of the adapter: when the object adapter is deactivated, so are its servant locators.

The `findServantLocator` operation allows you retrieve the servant locator for a specific category (including the empty category). If no servant locator is registered for the specified category, `findServantLocator` returns null.

Call Dispatch Semantics

The preceding rules may seem complicated, so here is a summary of the actions taken by the Ice run time to locate a servant for an incoming request.

Every incoming request implicitly identifies a specific object adapter for the request (because the request arrives at a specific transport endpoint and, therefore, identifies a particular object adapter). The incoming request carries an object identity that must be mapped to a servant. To locate a servant, the Ice run time goes through the following steps, in the order shown:

1. Look for the identity in the ASM. If the ASM contains an entry, dispatch the request to the corresponding servant.
2. If the category of the incoming object identity is non-empty, look for a servant locator that is registered for that category. If such a servant locator is registered, call `locate` on the servant locator and, if `locate` returns a servant, dispatch the request to that servant, followed by a call to `finished`; otherwise, if the call to `locate` returns null, raise `ObjectNotExistException` or `FacetNotExistException` in the client. (`ObjectNotExistException` is raised if the ASM does not contain a servant with the given identity at all, `FacetNotExistException` is raised if the ASM contains a servant with a matching name, but a non-matching category.)
3. If the category of the incoming object identity is empty, or no servant locator could be found for the category in step 2, look for a default servant locator (that is, a servant locator that is registered for the empty category). If a default servant locator is registered, dispatch the request as for step 2.
4. Raise `ObjectNotExistException` or `FacetNotExistException` in the client.

It is important to keep these call dispatch semantics in mind because they enable a number of powerful implementation techniques. Each technique allows you to streamline your server implementation and to precisely control the trade-off between performance, memory consumption, and scalability. To illustrate the possibilities, we outline a number of the most common implementation techniques in the following section.

31.7.5 Implementing a Simple Servant Locator

To illustrate the concepts outlined in the previous sections, let us examine a (very simple) implementation of a servant locator. Consider that we want to create an electronic phone book for the entire world's telephone system (which, clearly, involves a very large number of entries, certainly too many to hold the entire

```

        virtual void finished(const Ice::Current&      c,
                               const Ice::ObjectPtr&  servant,
                               const Ice::LocalObjectPtr& cookie);

        virtual void deactivate(const std::string& category);
};

```

Note that `MyServantLocator` inherits from `Ice::ServantLocator` and implements the pure virtual functions that are generated by the `slice2cpp` compiler for the `Ice::ServantLocator` interface. Of course, as always, you can add additional member functions, such as a constructor and destructor, and you can add private data members as necessary to support your implementation.

In C++, you can implement the `locate` member function along the following lines:

```

Ice::ObjectPtr
MyServantLocator::locate(const Ice::Current& c,
                          Ice::LocalObjectPtr& cookie)
{
    // Get the object identity. (We use the name member
    // as the database key.)
    //
    std::string name = c.id.name;

    // Use the identity to retrieve the state from the database.
    //
    ServantDetails d;
    try {
        d = DB_lookup(name);
    } catch (const DB_error&)
        return 0;
    }

    // We have the state, instantiate a servant and return it.
    //
    return new PhoneEntryI(d);
}

```

For the time being, the implementations of `finished` and `deactivate` are empty and do nothing.

The `DB_lookup` call in the preceding example is assumed to access the database. If the lookup fails (presumably, because no matching record could be found), `DB_lookup` throws a `DB_error` exception. The code catches that

exception and returns zero its stead; this raises `ObjectNotExistException` in the client to indicate that the client used a proxy to a no-longer existent Ice object.

Note that `locate` instantiates the servant on the heap and returns it to the Ice run time. This raises the question of when the servant will be destroyed. The answer is that the Ice run time holds onto the servant for as long as necessary, that is, long enough to invoke the operation on the returned servant and to call `finished` once the operation has completed. Thereafter, the servant is no longer needed and the Ice run time destroys the smart pointer that was returned by `locate`. In turn, because no other smart pointers exist for the same servant, this causes the destructor of the `PhoneEntryI` instance to be called, and the servant to be destroyed.

The upshot of this design is that, for every incoming request, we instantiate a servant and allow the Ice run time to destroy the servant once the request is complete. Depending on your application, this may be exactly what is needed, or it may be prohibitively expensive—we will explore designs that avoid creation and destruction of a servant for every request shortly.

In Java, the implementation of our servant locator looks very similar:⁵

```
public class MyServantLocator
    extends Ice.LocalObjectImpl
    implements Ice.ServantLocator {

    public Ice.Object locate(Ice.Current c,
                            Ice.LocalObjectHolder cookie)
    {
        // Get the object identity. (We use the name member
        // as the database key.
        String name = c.id.name;

        // Use the identity to retrieve the state
        // from the database.
        //
        ServantDetails d;
        try {
            d = DB.lookup(name);
        } catch (DB.error e) {
            return null;
        }
    }
}
```

5. The C# implementation is virtually identical to the Java implementation, so we do not show it here.

```
        // We have the state, instantiate a servant and return it.
        //
        return new PhoneEntryI(d);
    }

    public void finished(Ice.Current c,
                        Ice.Object servant,
                        Ice.LocalObject cookie)
    {
    }

    public void deactivate(String category)
    {
    }
}
```

Note that the `MyServantLocator` class extends `Ice.LocalObjectImpl`. `LocalObjectImpl` is provided by the Ice run time and contains the implementation of methods that are common to all local objects (namely, `equals`, `clone`, and `ice_getHash`).

All implementations of `locate` follow the pattern illustrated by the previous pseudo-code:

1. Use the `id` member of the passed `Current` object to obtain the object identity. Typically, only the `name` member of the identity is used to retrieve servant state. The `category` member is normally used to select a servant locator. (We will explore use of the `category` member shortly.)
2. Retrieve the state of the Ice object from secondary storage (or the network) using the object identity as a key.
 - If the lookup succeeds, you have retrieved the state of the Ice object.
 - If the lookup fails, return `null`. In that case, the Ice object for the client's request truly does not exist, presumably, because that Ice object was deleted earlier, but the client still has a proxy to the now-deleted object.
3. Instantiate a servant and use the state retrieved from the database to initialize the servant. (In this example, we pass the retrieved state to the servant constructor.)
4. Return the servant.

Of course, before we can use our servant locator, we must inform the adapter of its existence prior to activating the adapter, for example (in Java or C#):

```
MyServantLocator sl = new MyServantLocator();
adapter.addServantLocator(sl, "");
```

Note that, in this example, we have installed the servant locator for the empty category. This means that `locate` on our servant locator will be called for invocations to any of our Ice objects (because the empty category acts as the default). In effect, with this design, we are not using the category member of the object identity. This is fine, as long as all our servants all have the same, single interface. However, if we need to support several different interfaces in the same server, this simple strategy is no longer sufficient.

31.7.6 Using the category Member of the Object Identity

The simple example in the preceding section always instantiates a servant of type `PhoneEntryI`. In other words, the servant locator implicitly is aware of the type of servant the incoming request is for. This is not a very realistic assumption for most servers because, usually, a server provides access to objects with several different interfaces. This poses a problem for our `locate` implementation: somehow, we need to decide inside `locate` what type of servant to instantiate. You have several options for solving this problem:

- Use a separate object adapter for each interface type and use a separate servant locator for each object adapter.

This technique works fine, but has the down-side that each object adapter requires a separate transport endpoint, which is wasteful.

- Mangle a type identifier into the name component of the object identity.

This technique uses part of the object identity to denote what type of object to instantiate. For example, in our file system application, we have directory and file objects. By convention, we could prepend a ‘d’ to the identity of every directory and prepend an ‘f’ to the identity of every file. The servant locator then can use the first letter of the identity to decide what type of servant to instantiate:

```
Ice::ObjectPtr
MyServantLocator::locate(const Ice::Current& c,
                        Ice::LocalObjectPtr& cookie)
{
    // Get the object identity. (We use the name member
    // as the database key.)
    //
    std::string name = c.id.name;
```

```

std::string realId = c.id.name.substr(1);
try {
    if(name[0] == 'd') {
        // The request is for a directory.
        //
        DirectoryDetails d = DB_lookup(realId);
        return new DirectoryI(d);
    } else {
        // The request is for a file.
        //
        FileDetails d = DB_lookup(realId);
        return new FileI(d);
    }
} catch (DatabaseNotFoundException&) {
    return 0;
}
}

```

While this works, it is awkward: not only do we need to parse the name member to work out what type of object to instantiate, but we also need to modify the implementation of `locate` whenever we add a new type to our application.

- Use the category member of the object identity to denote the type of servant to instantiate.

This is the recommended approach: for every interface type, we assign a separate identifier as the value of the category member of the object identity. (For example, we can use ‘d’ for directories and ‘f’ for files.) Instead of registering a single servant locator, we create two different servant locator implementations, one for directories and one for files, and then register each locator for the appropriate category:

```

class DirectoryLocator : public virtual Ice::ServantLocator {
public:

    virtual Ice::ObjectPtr locate(const Ice::Current& c,
                                  Ice::LocalObjectPtr& cookie)
    {
        // Code to locate and instantiate a directory here...
    }

    virtual void finished(const Ice::Current& c,
                          const Ice::ObjectPtr& servant,
                          const Ice::LocalObjectPtr& cookie)

```

```

    {
    }

    virtual void deactivate(const std::string& category)
    {
    }
};

class FileLocator : public virtual Ice::ServantLocator {
public:

    virtual Ice::ObjectPtr locate(const Ice::Current& c,
                                  Ice::LocalObjectPtr& cookie)
    {
        // Code to locate and instantiate a file here...
    }

    virtual void finished(const Ice::Current& c,
                          const Ice::ObjectPtr& servant,
                          const Ice::LocalObjectPtr& cookie)
    {
    }

    virtual void deactivate(const std::string& category)
    {
    }
};

// ...

// Register two locators, one for directories and
// one for files.
//
adapter->addServantLocator(new DirectoryLocator(), "d");
adapter->addServantLocator(new FileLocator(), "f");

```

Yet another option is to use the `category` member of the object identity, but to use a single default servant locator (that is, a locator for the empty category). With this approach, all invocations go to the single default servant locator, and you can switch on the `category` value inside the implementation of the `locate` operation to determine which type of servant to instantiate. However, this approach is harder to maintain than the previous one; the `category` member of the Ice object identity exists specifically to support servant locators, so you might as well use it as intended.

31.7.7 Using Cookies

Occasionally, it can be useful to be able to pass information between `locate` and `finished`. For example, the implementation of `locate` could choose among a number of alternative database backends, depending on load or availability and, to properly finalize state, the implementation of `finished` might need to know which database was used by `locate`. To support such scenarios, you can create a cookie in your `locate` implementation; the Ice run time passes the value of the cookie to `finished` after the operation invocation has completed. The cookie must be derived from `Ice::LocalObject` and can contain whatever state and member functions are useful to your implementation:

```
class MyCookie : public virtual Ice::LocalObject {
public:
    // Whatever is useful here...
};

typedef IceUtil::Handle<MyCookie> MyCookiePtr;

class MyServantLocator : public virtual Ice::ServantLocator {
public:

    virtual Ice::ObjectPtr locate(const Ice::Current& c,
                                  Ice::LocalObjectPtr& cookie)
    {
        // Code as before...

        // Allocate and initialize a cookie.
        //
        cookie = new MyCookie(...);

        return new PhoneEntryI();
    }

    virtual void finished(const Ice::Current& c,
                          const Ice::ObjectPtr& servant,
                          const Ice::LocalObjectPtr& cookie)
    {
        // Down-cast cookie to actual type.
        //
        MyCookiePtr mc = MyCookiePtr::dynamicCast(cookie);

        // Use information in cookie to clean up...
        //
        // ...
    }
};
```

```
    }  
    virtual void deactivate(const std::string& category);  
};
```

31.8 Server Implementation Techniques

As we mentioned on page 800, instantiating a servant for each Ice object on server start-up is a viable design, provided that you can afford the amount of memory required by the servants, as well as the delay in start-up of the server. However, Ice supports more flexible mappings between Ice objects and servants; these alternate mappings allow you to precisely control the trade-off between memory consumption, scalability, and performance. We outline a few of the more common implementation techniques in this section.

31.8.1 Incremental Initialization

If you use a servant locator, the servant returned by `locate` is used only for the current request, that is, the Ice run time does not add the servant to the active servant map. Of course, this means that if another request comes in for the same Ice object, `locate` must again retrieve the object state and instantiate a servant. A common implementation technique is to add each servant to the ASM as part of `locate`. This means that only the first request for each Ice object triggers a call to `locate`; thereafter, the servant for the corresponding Ice object can be found in the ASM and the Ice run time can immediately dispatch another incoming request for the same Ice object without having to call the servant locator.

An implementation of `locate` to do this would look something like the following:

```
Ice::ObjectPtr  
MyServantLocator::locate(const Ice::Current& c,  
                        Ice::LocalObjectPtr& cookie)  
{  
    // Get the object identity. (We use the name member  
    // as the database key.)  
    //  
    std::string name = c.id.name;  
  
    // Use the identity to retrieve the state from the database.  
    //
```

```

    ServantDetails d;
    try {
        d = DB_lookup(name);
    } catch (const DB_error&)
        return 0;
    }

    // We have the state, instantiate a servant.
    //
    Ice::ObjectPtr servant = new PhoneEntryI(d);

    // Add the servant to the ASM.
    //
    c.adapter->add(servant, c.id);      // NOTE: Incorrect!

    return servant;
}

```

This is almost identical to the implementation on page 808—the only difference is that we also add the servant to the ASM by calling `ObjectAdapter::add`. Unfortunately, this implementation is wrong because it suffers from a race condition. Consider the situation where we do not have a servant for a particular Ice object in the ASM, and two clients more or less simultaneously send a request for the same Ice object. It is entirely possible for the thread scheduler to schedule the two incoming requests such that the Ice run time completes the lookup in the ASM for both requests and, for each request, concludes that no servant is in memory. The net effect is that `locate` will be called twice for the same Ice object, and our servant locator will instantiate two servants instead of a single servant. Because the second call to `ObjectAdapter::add` will raise an `AlreadyRegisteredException`, only one of the two servants will be added to the ASM.

Of course, this is hardly the behavior we expect. To avoid the race condition, our implementation of `locate` must check whether a concurrent invocation has already instantiated a servant for the incoming request and, if so, return that servant instead of instantiating a new one. The Ice run time provides the `ObjectAdapter::find` operation to allow us to test whether an entry for a specific identity already exists in the ASM:

```

module Ice {
    local interface ObjectAdapter {
        // ...

        Object find(Identity id);
    }
}

```

```

        // ...
    };
};

```

`find` returns the servant if it exists in the ASM and null, otherwise. Using this lookup function, together with a mutex, allows us to correctly implement `locate`. The class definition of our servant locator now has a private mutex so we can establish a critical region inside `locate`:

```

class MyServantLocator : public virtual Ice::ServantLocator {
public:

    virtual Ice::ObjectPtr locate(const Ice::Current& c,
                                  Ice::LocalObjectPtr&);

    // Declaration of finished() and deactivate() here...

private:
    IceUtil::Mutex _m;
};

```

The `locate` member function locks the mutex and tests whether a servant is already in the ASM: if so, it returns that servant; otherwise, it instantiates a new servant and adds it to the ASM as before:

```

Ice::ObjectPtr
MyServantLocator::locate(const Ice::Current& c,
                          Ice::LocalObjectPtr&)
{
    IceUtil::Mutex::Lock lock(_m);

    // Check if we have instantiated a servant already.
    //
    Ice::ObjectPtr servant = c.adapter.find(c.id);

    if(!servant) { // We don't have a servant already

        // Instantiate a servant.
        //
        ServantDetails d;
        try {
            d = DB_lookup(c.id.name);
        } catch (const DB_error&) {
            return 0;
        }
    }
}

```

```

        servant = new PhoneEntryI(d);

        // Add the servant to the ASM.
        //
        c.adapter->add(servant, c.id);
    }

    return servant;
}

```

The Java version of this locator is almost identical, but we use the `synchronized` qualifier instead of a mutex to make `locate` a critical region:⁶

```

synchronized public Ice.Object
locate(Ice.Current c, Ice.LocalObjectHolder cookie)
{
    // Check if we have instantiated a servant already.
    //
    Ice.Object servant = c.adapter.find(c.id);

    if(servant == null) { // We don't have a servant already

        // Instantiate a servant
        //
        ServantDetails d;
        try {
            d = DB.lookup(c.id.name);
        } catch (DB.error&) {
            return null;
        }
        servant = new PhoneEntryI(d);
    }

    return servant;
}

```

Using a servant locator that adds the servant to the ASM has a number of advantages:

- Servants are instantiated on demand, so the cost of initializing the servants is spread out over many invocations instead of being incurred all at once during server start-up.

6. In C#, you can place the body of `locate` into a `lock(this)` statement.

- The memory requirements for the server are reduced because servants are instantiated only for those Ice objects that are actually accessed by clients. If clients only access a subset of the total number of Ice objects, the memory savings can be substantial.

In general, incremental initialization is beneficial if instantiating servants during start-up is too slow. The memory savings can be worthwhile as well but, as a rule, are realized only for comparatively short-lived servers: for long-running servers, chances are that, sooner or later, every Ice object will be accessed by some client or another; in that case, there are no memory savings because we end up with an instantiated servant for every Ice object regardless.

31.8.2 Default Servants

A common problem with object-oriented middleware is scalability: servers frequently are used as front ends to large databases that are accessed remotely by clients. The servers' job is to present an object-oriented view to clients of a very large number of records in the database. Typically, the number of records is far too large to instantiate servants for even a fraction of the database records.

A common technique for solving this problem is to use *default servants*. A default servant is a servant that, for each request, takes on the persona of a different Ice object. In other words, the servant changes its behavior according to the object identity that is accessed by a request, on a per-request basis. In this way, it is possible to allow clients access to an unlimited number of Ice objects with only a single servant in memory.

Default servant implementations are attractive not only because of the memory savings they offer, but also because of the simplicity of implementation: in essence, a default servant is a facade [2] to the persistent state of an object in the database. This means that the programming required to implement a default servant is typically minimal: it simply consists of the code required to read and write the corresponding database records.

To create a default servant implementation, we need as many locators as there are non-abstract interfaces in the system. For example, for our file system application, we require two locators, one for directories and one for files. In addition, the object identities we create use the category member of the object identity to encode the type of interface of the corresponding Ice object. The value of the category field can be anything that identifies the interface, such as the 'd' and 'f' convention we used on page 812. Alternatively, you could use "Directory" and "File", or use the type ID of the corresponding interface, such as

"::Filesystem::Directory" and "::Filesystem::File". The name member of the object identity must be set to whatever identifier we can use to retrieve the persistent state of each directory and file from secondary storage. (For our file-system application, we used a UUID as a unique identifier.)

The servant locators each return a singleton servant from their respective locate implementations. Here is the servant locator for directories:

```
class DirectoryLocator : public virtual Ice::ServantLocator {
public:
    DirectoryLocator() : _servant(new DirectoryI)
    {
    }

    virtual Ice::ObjectPtr locate(const Ice::Current&,
                                   Ice::LocalObjectPtr&)
    {
        return _servant;
    }

    virtual void finished(const Ice::Current&,
                          const Ice::ObjectPtr&,
                          const Ice::LocalObjectPtr&)
    {
    }

    virtual void deactivate(const std::string&)
    {
    }

private:
    Ice::ObjectPtr _servant;
};
```

Note that constructor of the locator instantiates a servant and returns that same servant from every call to `locate`. The implementation of the file locator is analogous to the one for directories. Registration of the servant locators proceeds as usual:

```
_adapter->addServantLocator(new DirectoryLocator, "d");
_adapter->addServantLocator(new FileLocator, "f");
```

All the action happens in the implementation of the operations, using the following steps for each operation:

1. Use the passed `Current` object to get the identity for the current request.

2. Use the name member of the identity to locate the persistent state of the servant on secondary storage. If no record can be found for the identity, throw an `ObjectNotExistException`.
3. Implement the operation to operate on that retrieved state (returning the state or updating the state as appropriate for the operation).

In pseudo-code, this might look something like the following:

```

Filesystem::NodeSeq
Filesystem::DirectoryI::list(const Ice::Current& c) const
{
    // Use the identity of the directory to retrieve
    // its contents.
    DirectoryContents dc;
    try {
        dc = DB_getDirectory(c.id.name);
    } catch(const DB_error&) {
        throw Ice::ObjectNotExistException(__FILE__, __LINE__);
    }

    // Use the records retrieved from the database to
    // initialize return value.
    //
    Filesystem::NodeSeq ns;
    // ...

    return ns;
}

```

Note that the servant implementation is completely stateless: the only state it operates on is the identity of the Ice object for the current request (and that identity is passed as part of the `Current` parameter). The price we have to pay for the unlimited scalability and reduced memory footprint is performance: default servants make a database access for every invoked operation which is obviously slower than caching state in memory, as part of a servant that has been added to the ASM. However, this does not mean that default servants carry an unacceptable performance penalty: databases often provide sophisticated caching, so even though the operation implementations read and write the database, as long as they access cached state, performance may be entirely acceptable.

Overriding `ice_ping`

One issue you need to be aware of with default servants is the need to override `ice_ping`: the default implementation of `ice_ping` that the servant inherits

from its skeleton class always succeeds. For servants that are registered with the ASM, this is exactly what we want; however, for default servants, `ice_ping` must fail if a client uses a proxy to a no-longer existent Ice object. To avoid getting successful `ice_ping` invocations for non-existent Ice objects, you must override `ice_ping` in the default servant. The implementation must check whether the object identity for the request denotes a still-existing Ice object and, if not, throw `ObjectNotExistException`:

```
void
Filesystem::DirectoryI::ice_ping(const Ice::Current& c) const
{
    try {
        d = DB_lookup(c.id.name);
    } catch (const DB_error&) {
        throw Ice::ObjectNotExistException(__FILE__, __LINE__);
    }
}
```

It is good practice to override `ice_ping` if you are using default servants.

31.8.3 Hybrid Approaches and Caching

Depending on the nature of your application, you may be able to steer a middle path that provides better performance while keeping memory requirements low: if your application has a number of frequently-accessed objects that are performance-critical, you can add servants for those objects to the ASM. If you store the state of these objects in data members inside the servants, you effectively have a cache of these objects.

The remaining, less-frequently accessed objects can be implemented with a default servant. For example, in our file system implementation, we could choose to instantiate directory servants permanently, but to have file objects implemented with a default servant. This provides efficient navigation through the directory tree and incurs slower performance only for the (presumably less frequent) file accesses.

This technique could be augmented with a cache of recently-accessed files, along similar lines to the buffer pool used by the UNIX kernel [10]. The point is that you can combine use of the ASM with servant locators and default servants to precisely control the trade-offs among scalability, memory consumption, and performance to suit the needs of your application.

31.8.4 Servant Evictors

A variation on the previous theme and particularly interesting use of a servant locator is as an *evictor* [4]. An evictor is a servant locator that maintains a cache of servants:

- Whenever a request arrives (that is, `locate` is called by the Ice run time), the evictor checks to see whether it can find a servant for the request in its cache. If so, it returns the servant that is already instantiated in the cache; otherwise, it instantiates a servant and adds it to the cache.
- The cache is a queue that is maintained in least-recently used (LRU) order: the least-recently used servant is at the tail of the queue, and the most-recently used servant is at the head of the queue. Whenever a servant is returned from or added to the cache, it is moved from its current queue position to the head of the queue, that is, the “newest” servant is always at the head, and the “oldest” servant is always at the tail.
- The queue has a configurable length that corresponds to how many servants will be held in the cache; if a request arrives for an Ice object that does not have a servant in memory and the cache is full, the evictor removes the least-recently used servant at the tail of the queue from the cache in order to make room for the servant about to be instantiated at the head of the queue.

Figure 31.2 illustrates an evictor with a cache size of five after five invocations have been made, for object identities 1 to 5, in that order.

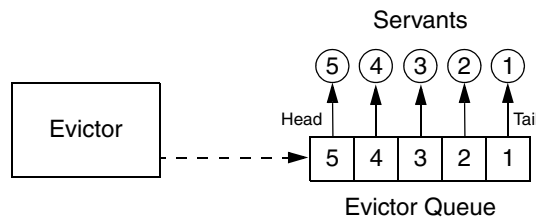

Figure 31.2. An evictor after five invocations for object identities 1 to 5.

At this point, the evictor has instantiated five servants, and has placed each servant onto the evictor queue. Because requests were sent by the client for object identities 1 to 5 (in that order), servant 5 ends up at the head of the queue (at the most-recently used position), and servant 1 ends up at the tail of the queue (at the least-recently used position).

Assume that the client now sends a request for servant 3. In this case, the servant is found on the evictor queue and moved to the head position. The resulting ordering is shown in Figure 31.3.

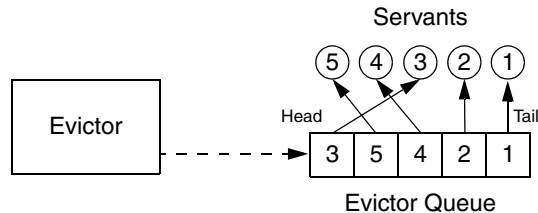

Figure 31.3. The evictor from Figure 31.2 after accessing servant 3.

Assume that the next client request is for object identity 6. The evictor queue is fully populated, so the evictor creates a servant for object identity 6, places that servant at the head of the queue, and evicts the servant with identity 1 (the least-recently used servant) at the tail of the queue, as shown in Figure 31.4.

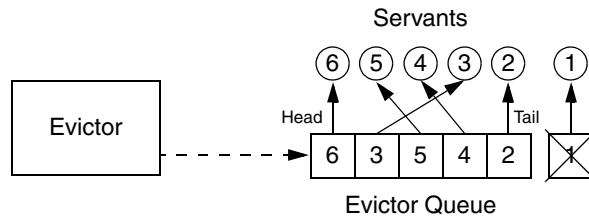

Figure 31.4. The evictor from Figure 31.3 after evicting servant 1.

The evictor pattern combines the advantages of the ASM with the advantages of a default servant: provided that the cache size is sufficient to hold the working set of servants in memory, most requests are served by an already instantiated servant, without incurring the overhead of creating a servant and accessing the database to initialize servant state. By setting the cache size, you can control the trade-off between performance and memory consumption as appropriate for your application.

The following sections show how to implement an evictor in both C++ and Java. (You can also find the source code for the evictor with the code examples for this book in the Ice distribution.)

Creating an Evictor Implementation in C++

The evictor we show here is designed as an abstract base class: in order to use it, you derive an object from the `EvictorBase` base class and implement two methods that are called by the evictor when it needs to add or evict a servant. This leads to a class definitions as follows:

```
class EvictorBase : public Ice::ServantLocator {
public:

    EvictorBase(int size = 1000);

    virtual Ice::ObjectPtr locate(const Ice::Current& c,
                                  Ice::LocalObjectPtr& cookie);
    virtual void finished(const Ice::Current& c,
                          const Ice::ObjectPtr& servant,
                          const Ice::LocalObjectPtr& cookie);
    virtual void deactivate(const std::string& category);

    virtual Ice::ObjectPtr add(const Ice::Current& c,
                               Ice::LocalObjectPtr& cookie) = 0;
    virtual void evict(const Ice::ObjectPtr& servant,
                      const Ice::LocalObjectPtr& cookie) = 0;

private:
    // ...
};
typedef IceUtil::Handle<EvictorBase> EvictorBasePtr;
```

Note that the evictor has a constructor that sets the size of the queue, with a default argument to set the size to 1000.

The `locate`, `finished`, and `deactivate` functions are inherited from the `ServantLocator` base class; these functions implement the logic to maintain the queue in LRU order and to add and evict servants as needed.

The `add` and `evict` functions are called by the evictor when it needs to add a new servant to the queue and when it evicts a servant from the queue. Note that these functions are pure virtual, so they must be implemented in a derived class. The job of `add` is to instantiate and initialize a servant for use by the evictor. The `evict` function is called by the evictor when it evicts a servant. This allows `evict` to perform any cleanup. Note that `add` can return a cookie that the evictor passes to `evict`, so you can move context information from `add` to `evict`.

Next, we need to consider the data structures that are needed to support our evictor implementation. We require two main data structures:

1. A map that maps object identities to servants, so we can efficiently decide whether we have a servant for an incoming request in memory or not.
2. A list that implements the evictor queue. The list is kept in LRU order at all times.

The evictor map does not only store servants but also keeps track of some administrative information:

1. The map stores the cookie that is returned from `add`, so we can pass that same cookie to `evict`.
2. The map stores an iterator into the evictor queue that marks the position of the servant in the queue. Storing the queue position is not strictly necessary—we store the position for efficiency reasons because it allows us to locate a servant’s position in the queue in constant time instead of having to search through the queue in order to maintain its LRU property.
3. The map stores a use count that is incremented whenever an operation is dispatched into a servant, and decremented whenever an operation completes.

The need for the use count deserves some extra explanation: suppose a client invokes a long-running operation on an Ice object with identity *I*. In response, the evictor adds a servant for *I* to the evictor queue. While the original invocation is still executing, other clients invoke operations on various Ice objects, which leads to more servants for other object identities being added to the queue. As a result, the servant for identity *I* gradually migrates toward the tail of the queue. If enough client requests for other Ice objects arrive while the operation on object *I* is still executing, the servant for *I* could be evicted while it is still executing the original request.

By itself, this will not do any harm. However, if the servant is evicted and a client then invokes another request on object *I*, the evictor would have no idea that a servant for *I* is still around and would add a second servant for *I*. However, having two servants for the same Ice object in memory is likely to cause problems, especially if the servant’s operation implementations write to a database.

The use count allows us to avoid this problem: we keep track of how many requests are currently executing inside each servant and, while a servant is busy, avoid evicting that servant. As a result, the queue size is not a hard upper limit: long-running operations can temporarily cause more servants than the limit to appear in the queue. However, as soon as excess servants become idle, they are evicted as usual.

The evictor queue does not store the identity of the servant. Instead, the entries on the queue are iterators into the evictor map. This is useful when the time comes to evict a servant: instead of having to search the map for the identity of the servant to be evicted, we can simply delete the map entry that is pointed at by the iterator at the tail of the queue. We can get away with storing an iterator into the evictor queue as part of the map, and storing an iterator into the evictor map as part of the queue because both `std::list` and `std::map` do not invalidate iterators when we add or delete entries (except for invalidating iterators that point at a deleted entry, of course).

Finally, our `locate` and `finished` implementations will need to exchange a cookie that contains a smart pointer to the entry in the evictor map. This is necessary so that `finished` can decrement the servant's use count.

This leads to the following definitions in the private section of our evictor:

```
class EvictorBase : public Ice::ServantLocator {
public:
    // ...

private:
    struct EvictorEntry;
    typedef IceUtil::Handle<EvictorEntry> EvictorEntryPtr;

    typedef std::map<Ice::Identity, EvictorEntryPtr> EvictorMap;
    typedef std::list<EvictorMap::iterator> EvictorQueue;

    struct EvictorEntry : public Ice::LocalObject {
        Ice::ObjectPtr servant;
        Ice::LocalObjectPtr userCookie;
        EvictorQueue::iterator pos;
        int useCount;
    };

    struct EvictorCookie : public Ice::LocalObject {
        EvictorEntryPtr entry;
    };
    typedef IceUtil::Handle<EvictorCookie> EvictorCookiePtr;

    EvictorMap _map;
    EvictorQueue _queue;
    Ice::Int _size;
};
```

```

    IceUtil::Mutex _mutex;

    void evictServants();
};

```

Note that the evictor stores the evictor map, queue, and the queue size in the private data members `_map`, `_queue`, and `_size`. In addition, we use a private `_mutex` data member so we can correctly serialize access to the evictor's data structures.

The `evictServants` member function takes care of evicting servants when the queue length exceeds its limit—we will discuss this function in more detail shortly.

The implementation of the constructor is trivial. The only point of note is that we ignore negative sizes:⁷

```

EvictorBase::EvictorBase(Ice::Int size) : _size(size)
{
    if (_size < 0)
        _size = 1000;
}

```

Almost all the action of the evictor takes place in the implementation of `locate`:

```

Ice::ObjectPtr
EvictorBase::locate(const Ice::Current& c,
                   Ice::LocalObjectPtr& cookie)
{
    IceUtil::Mutex::Lock lock(_mutex);

    // Create a cookie.
    //
    EvictorCookiePtr ec = new EvictorCookie;
    cookie = ec;

    // Check if we have a servant in the map already.
    //
    EvictorMap::iterator i = _map.find(c.id);
    bool newEntry = i == _map.end();
    if(!newEntry) {
        // Got an entry already, dequeue the entry from
        // its current position.
    }
}

```

7. We could have stored the size as a `size_t` instead. However, for consistency with the Java implementation, which cannot use unsigned integers, we use `Ice::Int` to store the size.

```

        //
        ec->entry = i->second;
        _queue.erase(ec->entry->pos);
    } else {
        // We do not have an entry. Ask the derived class to
        // instantiate a servant and add a new entry to the map.
        //
        ec->entry = new EvictorEntry;
        ec->entry->servant
            = add(c, ec->entry->userCookie); // Down-call
        if(!ec->entry->servant)
        {
            return 0;
        }
        ec->entry->useCount = 0;
        i = _map.insert(std::make_pair(c.id, ec->entry)).first;
    }

    // Increment the use count of the servant and enqueue
    // the entry at the front, so we get LRU order.
    //
    ++(ec->entry->useCount);
    ec->entry->pos = _queue.insert(_queue.begin(), i);

    return ec->entry->servant;
}

```

The first step in `locate` is to lock the `_mutex` data member. This protects the evictor's data structures from concurrent access. The next step is to create the cookie that is returned from `locate` and will be passed by the Ice run time to the corresponding call to `finished`. The cookie contains a smart pointer to an evictor entry, of type `EvictorEntryPtr`. This is also the value type of our map entries, so we do not store two copies of the same information redundantly—instead, smart pointers ensure that a single copy is shared by both the cookie and the map.

The next step is to look in the evictor map to see whether we already have an entry for this object identity. If so, we initialize the cookie's smart pointer with that entry and remove the entry from its current queue position.

Otherwise, we do not have an entry for this object identity yet, so we have to create one. The code creates a new evictor entry, and then calls `add` to get a new servant. This is a down-call to the concrete class that will be derived from `EvictorBase`. The implementation of `add` must attempt to locate the object state for the Ice object with the identity passed inside the `Current` object and

either return a servant as usual, or return null or throw an exception to indicate failure. If `add` returns null, we return zero to let the Ice run time know that no servant could be found for the current request. If `add` succeeds, we initialize the entry's use count to zero and insert the entry into the evictor map.

The last few lines of `locate` add the entry for the current request to the head of the evictor queue to maintain its LRU property, increment the use count of the entry, and finally return the servant to the Ice run time.

The implementation of `finished` is comparatively simple. It decrements the use count of the entry and then calls `evictServants` to get rid of any servants that might need to be evicted:

```
void
EvictorBase::finished(const Ice::Current&,
                     const Ice::ObjectPtr&,
                     const Ice::LocalObjectPtr& cookie)
{
    IceUtil::Mutex::Lock lock(_mutex);

    EvictorCookiePtr ec = EvictorCookiePtr::dynamicCast(cookie);

    // Decrement use count and check if
    // there is something to evict.
    //
    --(ec->entry->useCount);
    evictServants();
}
```

In turn, `evictServants` examines the evictor queue: if the queue length exceeds the evictor's size, the excess entries are scanned. Any entries with a zero use count are then evicted:

```
void
EvictorBase::evictServants()
{
    // If the evictor queue has grown larger than the limit,
    // look at the excess elements to see whether any of them
    // can be evicted.
    //
    for (int i = static_cast<int>(_map.size() - _size);
         i > 0; --i) {
        EvictorQueue::reverse_iterator p = _queue.rbegin();
        if ((*p)->second->useCount == 0) {
            evict ((*p)->second->servant, (*p)->second->userCookie);
            EvictorMap::iterator pos = *p;
            _queue.erase ((*p)->second->pos);
        }
    }
}
```

```

        _map.erase(pos);
    }
}

```

The code scans the excess entries, starting at the tail of the evictor queue. If an entry has a zero use count, it is evicted: after calling the `evict` member function in the derived class, the code removes the evicted entry from both the map and the queue.

Finally, the implementation of `deactivate` sets the evictor size to zero and then calls `evictServants`. This results in eviction of all servants. The Ice run time guarantees to call `deactivate` only once no more requests are executing in an object adapter; as a result, it is guaranteed that all entries in the evictor will be idle and therefore will be evicted.

```

void
EvictorBase::deactivate(const std::string& category)
{
    IceUtil::Mutex::Lock lock(_mutex);

    _size = 0;
    evictServants();
}

```

Creating an Evictor Implementation in Java

The evictor we show here is designed as an abstract base class: in order to use it, you derive an object from the `Evictor.EvictorBase` base class and implement two methods that are called by the evictor when it needs to add or evict a servant. This leads to a class definitions as follows:

```

package Evictor;

public abstract class EvictorBase
    extends Ice.LocalObjectImpl implements Ice.ServantLocator
{
    public
    EvictorBase()
    {
        _size = 1000;
    }

    public
    EvictorBase(int size)
    {

```

```

        _size = size < 0 ? 1000 : size;
    }

    public abstract Ice.Object
    add(Ice.Current c, Ice.LocalObjectHolder cookie);

    public abstract void
    evict(Ice.Object servant, Ice.LocalObject cookie);

    synchronized public final Ice.Object
    locate(Ice.Current c, Ice.LocalObjectHolder cookie)
    {
        // ...
    }

    synchronized public final void
    finished(Ice.Current c, Ice.Object o, Ice.LocalObject cookie)
    {
        // ...
    }

    synchronized public final void
    deactivate(String category)
    {
        // ...
    }

    // ...

    private int _size;
}

```

Note that the evictor has constructors to set the size of the queue, with a default size of 1000.

The `locate`, `finished`, and `deactivate` methods are inherited from the `ServantLocator` base class; these methods implement the logic to maintain the queue in LRU order and to add and evict servants as needed. The methods are synchronized, so the evictor's internal data structures are protected from concurrent access.

The `add` and `evict` methods are called by the evictor when it needs to add a new servant to the queue and when it evicts a servant from the queue. Note that these functions are abstract, so they must be implemented in a derived class. The job of `add` is to instantiate and initialize a servant for use by the evictor. The `evict` function is called by the evictor when it evicts a servant. This allows

`evict` to perform any cleanup. Note that `add` can return a cookie that the evictor passes to `evict`, so you can move context information from `add` to `evict`.

Next, we need to consider the data structures that are needed to support our evictor implementation. We require two main data structures:

1. A map that maps object identities to servants, so we can efficiently decide whether we have a servant for an incoming request in memory or not.
2. A list that implements the evictor queue. The list is kept in LRU order at all times.

The evictor map does not only store servants but also keeps track of some administrative information:

1. The map stores the cookie that is returned from `add`, so we can pass that same cookie to `evict`.
2. The map stores an iterator into the evictor queue that marks the position of the servant in the queue.
3. The map stores a use count that is incremented whenever an operation is dispatched into a servant, and decremented whenever an operation completes.

The last two points deserve some extra explanation.

- The evictor queue must be maintained in least-recently used order, that is, every time an invocation arrives and we find an entry for the identity in the evictor map, we also must locate the servant's identity on the evictor queue and move it to the front of the queue. However, scanning for that entry is inefficient because it requires $O(n)$ time. To get around this, we store an iterator in the evictor map that marks the corresponding entry's position in the evictor queue. This allows us to dequeue the entry from its current position and enqueue it at the head of the queue in $O(1)$ time.

Unfortunately, the various lists provided by `java.util` do not allow us to keep an iterator to a list position without invalidating that iterator as the list is updated. To deal with this, we use a special-purpose linked list implementation, `Evictor.LinkedList`, that does not have this limitation.

`LinkedList` has an interface similar to `java.util.LinkedList` but does not invalidate iterators other than iterators that point at an element that is removed. For brevity, we do not show the implementation of this list here—you can find the implementation in the code examples for this book in the Ice distribution.

- We maintain a use count as part of the map in order to avoid incorrect eviction of servants. Suppose a client invokes a long-running operation on an Ice object with identity *I*. In response, the evictor adds a servant for *I* to the evictor queue. While the original invocation is still executing, other clients invoke operations on various Ice objects, which leads to more servants for other object identities being added to the queue. As a result, the servant for identity *I* gradually migrates toward the tail of the queue. If enough client requests for other Ice objects arrive while the operation on object *I* is still executing, the servant for *I* could be evicted while it is still executing the original request.

By itself, this will not do any harm. However, if the servant is evicted and a client then invokes another request on object *I*, the evictor would have no idea that a servant for *I* is still around and would add a second servant for *I*. However, having two servants for the same Ice object in memory is likely to cause problems, especially if the servant's operation implementations write to a database.

The use count allows us to avoid this problem: we keep track of how many requests are currently executing inside each servant and, while a servant is busy, avoid evicting that servant. As a result, the queue size is not a hard upper limit: long-running operations can temporarily cause more servants than the limit to appear in the queue. However, as soon as excess servants become idle, they are evicted as usual.

Finally, our `locate` and `finished` implementations will need to exchange a cookie that contains a smart pointer to the entry in the evictor map. This is necessary so that `finished` can decrement the servant's use count.

This leads to the following definitions in the private section of our evictor:

```
package Evictor;

public abstract class EvictorBase
    extends Ice.LocalObjectImpl implements Ice.ServantLocator
{
    // ...

    private class EvictorEntry
    {
        Ice.Object servant;
        Ice.LocalObject userCookie;
        java.util.Iterator pos;
        int useCount;
    }
}
```



```

private class EvictorCookie extends Ice.LocalObjectImpl
{
    public EvictorEntry entry;
}

private void evictServants()
{
    // ...
}

private java.util.Map _map = new java.util.HashMap();
private Evictor.LinkedList _queue = new Evictor.LinkedList();
private int _size;
}

```

Note that the evictor stores the evictor map, queue, and the queue size in the private data members `_map`, `_queue`, and `_size`. The map key is the identity of the Ice object, and the lookup value is of type `EvictorEntry`. The queue simply stores identities, of type `Ice::Identity`.

The `evictServants` member function takes care of evicting servants when the queue length exceeds its limit—we will discuss this function in more detail shortly.

Almost all the action of the evictor takes place in the implementation of `locate`:

```

synchronized public final Ice.Object
locate(Ice.Current c, Ice.LocalObjectHolder cookie)
{
    // Create a cookie.
    //
    EvictorCookie ec = new EvictorCookie();
    cookie.value = ec;

    // Check if we a servant in the map already.
    //
    ec.entry = (EvictorEntry)_map.get(c.id);
    boolean newEntry = ec.entry == null;
    if(!newEntry) {
        // Got an entry already, dequeue the entry from
        // its current position.
        //
        ec.entry.pos.remove();
    } else {
        // We do not have entry. Ask the derived class to

```

```

        // instantiate a servant and add a new entry to the map.
        //
        ec.entry = new EvictorEntry();
        Ice.LocalObjectHolder cookieHolder
            = new Ice.LocalObjectHolder();
        ec.entry.servant = add(c, cookieHolder); // Down-call
        if(ec.entry.servant == null) {
            return null;
        }
        ec.entry.userCookie = cookieHolder.value;
        ec.entry.useCount = 0;
        _map.put(c.id, ec.entry);
    }

    // Increment the use count of the servant and enqueue
    // the entry at the front, so we get LRU order.
    //
    ++(ec.entry.useCount);
    _queue.addFirst(c.id);
    ec.entry.pos = _queue.iterator();
    ec.entry.pos.next(); // Position the iterator on the element.

    return ec.entry.servant;
}

```

The code creates a cookie that is returned from `locate` and will be passed by the Ice run time to the corresponding call to `finished`. The cookie contains an evictor entry, of type `EvictorEntry`.

We now look for an existing entry in the evictor map, using the object identity as the key. If we have an entry in the map already, we dequeue the corresponding identity from the evictor queue. (The `pos` member of `EvictorEntry` is an iterator that marks that entry's position in the evictor queue.)

Otherwise, we do not have an entry in the map, so we create a new one and call the `add` method. This is a down-call to the concrete class that will be derived from `EvictorBase`. The implementation of `add` must attempt to locate the object state for the Ice object with the identity passed inside the `Current` object and either return a servant as usual, or return `null` or throw an exception to indicate failure. If `add` returns `null`, we return `null` to let the Ice run time know that no servant could be found for the current request. If `add` succeeds, we initialize the entry's use count to zero and insert the entry into the evictor map.

The final few lines of code increment the entry's use count, add the entry at the head of the evictor queue, and store the entry's position in the queue before returning the servant to the Ice run time.

The implementation of `finished` is comparatively simple. It decrements the use count of the entry and then calls `evictServants` to get rid of any servants that might need to be evicted:

```
synchronized public final void
finished(Ice.Current c, Ice.Object o, Ice.LocalObject cookie)
{
    EvictorCookie ec = (EvictorCookie)cookie;

    // Decrement use count and check if
    // there is something to evict.
    //
    --(ec.entry.useCount);
    evictServants();
}
```

In turn, `evictServants` examines the evictor queue: if the queue length exceeds the evictor's size, the excess entries are scanned. Any entries with a zero use count are then evicted:

```
private void evictServants()
{
    // If the evictor queue has grown larger than the limit,
    // look at the excess elements to see whether any of them
    // can be evicted.
    //
    for(int i = _map.size() - _size; i > 0; --i) {
        java.util.Iterator p = _queue.riterator();
        Ice.Identity id = (Ice.Identity)p.next();
        EvictorEntry e = (EvictorEntry)_map.get(id);
        if(e.useCount == 0) {
            evict(e.servant, e.userCookie); // Down-call
            p.remove();
            _map.remove(id);
        }
    }
}
```

The code scans the excess entries, starting at the tail of the evictor queue. If an entry has a zero use count, it is evicted: after calling the `evict` member function in the derived class, the code removes the evicted entry from both the map and the queue.

Finally, the implementation of `deactivate` sets the evictor size to zero and then calls `evictServants`. This results in eviction of all servants. The Ice run time guarantees to call `deactivate` only once no more requests are executing

in an object adapter; as a result, it is guaranteed that all entries in the evictor will be idle and therefore will be evicted.

```
synchronized public final void
deactivate(String category)
{
    _size = 0;
    evictServants();
}
```

Creating an Evictor Implementation in C#

The `System.Collection` classes do not provide a container that does not invalidate iterators when we modify the contents of the container but, to efficiently implement an evictor, we need such a container. To deal with this, we use a special-purpose linked list implementation, `Evictor.LinkedList`, that does not invalidate iterators when we delete or add an element. For brevity, we only show the interface of `LinkedList` here—you can find the implementation in the code examples for this book in the Ice for C# distribution.

```
namespace Evictor
{
    public class LinkedList : ICollection, ICloneable
    {
        public LinkedList();

        public int Count { get; }
    }

    public void Add(object value);
    public void AddFirst(object value);

    public IEnumerator GetEnumerator();

    public class Enumerator : IEnumerator
    {
        public void Reset();

        public object Current { get; }

        public bool MoveNext();

        public bool MovePrev();
    }
}
```

```
        public void Remove();
    }

    public void CopyTo(Array array, int index);

    public object Clone();

    public bool IsSynchronized { get; }

    public object SyncRoot { get; }
}
}
```

The `Add` method appends an element to the list, and the `AddFirst` method prepends an element to the list. `GetEnumerator` returns an enumerator for the list elements; immediately after calling `GetEnumerator`, the enumerator does not point at any element until you call either `MoveNext` or `MovePrev`, which position the enumerator at the first and last element, respectively. `Current` returns the element at the enumerator position, and `Remove` deletes the element at the current position and leaves the enumerator pointing at no element. Calling `MoveNext` or `MovePrev` after calling `Remove` positions the enumerator at the element following or preceding the deleted element, respectively. `MoveNext` and `MovePrev` return true if they have positioned the enumerator on an element; otherwise, they return false and leave the enumerator position on the last and first element, respectively.

Given this `LinkedList`, we can implement the evictor. The evictor we show here is designed as an abstract base class: in order to use it, you derive an object from the `Evictor.EvictorBase` base class and implement two methods that are called by the evictor when it needs to add or evict a servant. This leads to a class definitions as follows:

```
namespace Evictor
{
    public abstract class EvictorBase
        : Ice.LocalObjectImpl, Ice.ServantLocator
    {

        public EvictorBase()
        {
            _size = 1000;
        }

        public EvictorBase(int size)
```

```

    {
        _size = size < 0 ? 1000 : size;
    }

    public abstract Ice.Object
        add(Ice.Current c,
           out Ice.LocalObject cookie);

    public abstract void evict(Ice.Object servant,
                               Ice.LocalObject cookie);

    public Ice.Object locate(Ice.Current c,
                             out Ice.LocalObject cookie)
    {
        lock(this)
        {
            // ...
        }
    }

    public void finished(Ice.Current c, Ice.Object o,
                         Ice.LocalObject cookie)
    {
        lock(this)
        {
            // ...
        }
    }

    public void deactivate(string category)
    {
        lock(this)
        {
            // ...
        }
    }

    private int _size;
}
}

```

Note that the evictor has constructors to set the size of the queue, with a default size of 1000.

The `locate`, `finished`, and `deactivate` methods are inherited from the `ServantLocator` base class; these methods implement the logic to maintain

the queue in LRU order and to add and evict servants as needed. The methods use a `lock(this)` statement for their body, so the evictor's internal data structures are protected from concurrent access.

The `add` and `evict` methods are called by the evictor when it needs to add a new servant to the queue and when it evicts a servant from the queue. Note that these functions are abstract, so they must be implemented in a derived class. The job of `add` is to instantiate and initialize a servant for use by the evictor. The `evict` function is called by the evictor when it evicts a servant. This allows `evict` to perform any cleanup. Note that `add` can return a cookie that the evictor passes to `evict`, so you can move context information from `add` to `evict`.

Next, we need to consider the data structures that are needed to support our evictor implementation. We require two main data structures:

1. A map that maps object identities to servants, so we can efficiently decide whether we have a servant for an incoming request in memory or not.
2. A list that implements the evictor queue. The list is kept in LRU order at all times.

The evictor map does not only store servants but also keeps track of some administrative information:

1. The map stores the cookie that is returned from `add`, so we can pass that same cookie to `evict`.
2. The map stores an iterator into the evictor queue that marks the position of the servant in the queue.
3. The map stores a use count that is incremented whenever an operation is dispatched into a servant, and decremented whenever an operation completes.

The last two points deserve some extra explanation.

- The evictor queue must be maintained in least-recently used order, that is, every time an invocation arrives and we find an entry for the identity in the evictor map, we also must locate the servant's identity on the evictor queue and move it to the front of the queue. However, scanning for that entry is inefficient because it requires $O(n)$ time. To get around this, we store an iterator in the evictor map that marks the corresponding entry's position in the evictor queue. This allows us to dequeue the entry from its current position and enqueue it at the head of the queue in $O(1)$ time, using the `Evictor.LinkedList` implementation we saw on page 838.

- We maintain a use count as part of the map in order to avoid incorrect eviction of servants. Suppose a client invokes a long-running operation on an Ice object with identity *I*. In response, the evictor adds a servant for *I* to the evictor queue. While the original invocation is still executing, other clients invoke operations on various Ice objects, which leads to more servants for other object identities being added to the queue. As a result, the servant for identity *I* gradually migrates toward the tail of the queue. If enough client requests for other Ice objects arrive while the operation on object *I* is still executing, the servant for *I* could be evicted while it is still executing the original request.

By itself, this will not do any harm. However, if the servant is evicted and a client then invokes another request on object *I*, the evictor would have no idea that a servant for *I* is still around and would add a second servant for *I*. However, having two servants for the same Ice object in memory is likely to cause problems, especially if the servant's operation implementations write to a database.

The use count allows us to avoid this problem: we keep track of how many requests are currently executing inside each servant and, while a servant is busy, avoid evicting that servant. As a result, the queue size is not a hard upper limit: long-running operations can temporarily cause more servants than the limit to appear in the queue. However, as soon as excess servants become idle, they are evicted as usual.

Finally, our `locate` and `finished` implementations will need to exchange a cookie that contains a smart pointer to the entry in the evictor map. This is necessary so that `finished` can decrement the servant's use count.

This leads to the following definitions in the private section of our evictor:

```
namespace Evictor
{
    public abstract class EvictorBase
        : Ice.LocalObjectImpl, Ice.ServantLocator
    {
        // ...

        private class EvictorEntry
        {
            internal Ice.Object servant;
            internal Ice.LocalObject userCookie;
            internal LinkedList.Enumerator pos;
            internal int useCount;
        }
    }
}
```



```

private class EvictorCookie : Ice.LocalObjectImpl
{
    public EvictorEntry entry;
}

private void evictServants()
{
    // ...
}

private System.Collections.Hashtable _map
    = new System.Collections.Hashtable();
private LinkedList _queue = new LinkedList();
private int _size;
}
}

```

Note that the evictor stores the evictor map, queue, and the queue size in the private data members `_map`, `_queue`, and `_size`. The map key is the identity of the Ice object, and the lookup value is of type `EvictorEntry`. The queue simply stores identities, of type `Ice.Identity`.

The `evictServants` member function takes care of evicting servants when the queue length exceeds its limit—we will discuss this function in more detail shortly.

Almost all the action of the evictor takes place in the implementation of `locate`:

```

public Ice.Object locate(Ice.Current c,
                        out Ice.LocalObject cookie)
{
    lock(this)
    {
        //
        // Create a cookie.
        //
        EvictorCookie ec = new EvictorCookie();

        //
        // Check if we have a servant in the map already.
        //
        ec.entry = (EvictorEntry)_map[c.id];
        bool newEntry = ec.entry == null;
        if(!newEntry)
        {

```

```

        //
        // Got an entry already, dequeue the entry
        // from its current position.
        //
        ec.entry.pos.Remove();
    }
    else
    {
        //
        // We do not have an entry. Ask the derived
        // class to instantiate a servant and add
        // a new entry to the map.
        //
        ec.entry = new EvictorEntry();
        Ice.LocalObject theCookie;
        ec.entry.servant = add(c, out theCookie);
        if(ec.entry.servant == null)
        {
            return null;
        }
        ec.entry.userCookie = theCookie;
        ec.entry.useCount = 0;
        _map[c.id] = ec.entry;
    }

    //
    // Increment the use count of the servant
    // and enqueue the entry at the front, so
    // we get LRU order.
    //
    ++(ec.entry.useCount);
    _queue.AddFirst(c.id);
    ec.entry.pos =
        (LinkedList.Enumerator)_queue.GetEnumerator();
    ec.entry.pos.MovePrev();
    cookie = ec;

    return ec.entry.servant;
}
}

```

The code creates a cookie that is returned from `locate` and will be passed by the Ice run time to the corresponding call to `finished`. The cookie contains an evictor entry, of type `EvictorEntry`.

We now look for an existing entry in the evictor map, using the object identity as the key. If we have an entry in the map already, we dequeue the corresponding identity from the evictor queue. (The `pos` member of `EvictorEntry` is an iterator that marks that entry's position in the evictor queue.)

Otherwise, we do not have an entry in the map, so we create a new one and call the `add` method. This is a down-call to the concrete class that will be derived from `EvictorBase`. The implementation of `add` must attempt to locate the object state for the Ice object with the identity passed inside the `Current` object and either return a servant as usual, or return null or throw an exception to indicate failure. If `add` returns null, we return null to let the Ice run time know that no servant could be found for the current request. If `add` succeeds, we initialize the entry's use count to zero and insert the entry into the evictor map.

The final few lines of code increment the entry's use count, add the entry at the head of the evictor queue, and store the entry's position in the queue before returning the servant to the Ice run time.

The implementation of `finished` is comparatively simple. It decrements the use count of the entry and then calls `evictServants` to get rid of any servants that might need to be evicted:

```
public void finished(Ice.Current c, Ice.Object o,
                    Ice.LocalObject cookie)
{
    lock(this)
    {
        EvictorCookie ec = (EvictorCookie)cookie;

        //
        // Decrement use count and check if
        // there is something to evict.
        //
        --(ec.entry).useCount;
        evictServants();
    }
}
```

In turn, `evictServants` examines the evictor queue: if the queue length exceeds the evictor's size, the excess entries are scanned. Any entries with a zero use count are then evicted:

```
private void evictServants()
{
    //
    // If the evictor queue has grown larger than the
```

```

// limit, look at the excess elements to see whether
// any of them can be evicted.
//
LinkedList.Enumerator p
    = (LinkedList.Enumerator)_queue.GetEnumerator();
for(int i = _map.Count - _size; i > 0; --i)
{
    p.MovePrev();
    Ice.Identity id = (Ice.Identity)p.Current;
    EvictorEntry e = (EvictorEntry)_map[id];
    if(e.useCount == 0)
    {
        evict(e.servant, e.userCookie);
        p.Remove();
        _map.Remove(id);
    }
}
}

```

The code scans the excess entries, starting at the tail of the evictor queue. If an entry has a zero use count, it is evicted: after calling the `evict` member function in the derived class, the code removes the evicted entry from both the map and the queue.

Finally, the implementation of `deactivate` sets the evictor size to zero and then calls `evictServants`. This results in eviction of all servants. The Ice run time guarantees to call `deactivate` only once no more requests are executing in an object adapter; as a result, it is guaranteed that all entries in the evictor will be idle and therefore will be evicted.

```

public void deactivate(string category)
{
    lock(this)
    {
        _size = 0;
        evictServants();
    }
}

```

Using Servant Evictors

Using a servant evictor is simply a matter of deriving a class from `EvictorBase` and implementing the `add` and `evict` methods. You can turn a servant locator into an evictor by simply taking the code that you wrote for `locate` and placing it into `add`—`EvictorBase` then takes care of main-

taining the cache in least-recently used order and evicting servants as necessary. Unless you have clean-up requirements for your servants (such as closing network connections or database handles), the implementation of `evict` can be left empty.

One of the nice aspects of evictors is that you do not need to change anything in your servant implementation: the servants are ignorant of the fact that an evictor is in use. This makes it very easy to add an evictor to an already existing code base with little disturbance of the source code.

Evictors can provide substantial performance improvements over default servants: especially if initialization of servants is expensive (for example, because servant state must be initialized by reading from a network), an evictor performs much better than a default servant, while keeping memory requirements low.

As we will see in XREF, evictors can also be useful to get rid of servants that have been abandoned by clients.

31.9 The Ice Threading Models

Ice is inherently a multi-threaded platform. There is no such thing as a single-threaded server in Ice. As a result, you must concern yourself with concurrency issues: if a thread reads a data structure while another thread updates the same data structure, havoc will ensue unless you protect the data structure with appropriate locks. In order to build Ice applications that behave correctly, it is important that you understand the threading semantics of the Ice run time. This section discusses the two concurrency models that Ice supports, called *thread pool* and *thread-per-connection*, and provides guidelines for writing thread-safe Ice applications.

31.9.1 Thread Pool

The thread-pool model is the default concurrency model in Ice. A thread pool is a collection of threads that the Ice run time draws upon to perform specific tasks. Each communicator creates at least two thread pools:

- The *client thread pool* services outgoing connections, which primarily involves handling the replies to outgoing requests and includes notifying AMI callback objects (see Section 32.3). If a connection is used in bidirectional mode (see Section 35.7), the client thread pool also dispatches incoming callback requests.

- The *server thread pool* services incoming connections. It dispatches incoming requests and, for bidirectional connections, processes replies to outgoing requests.

By default, these two thread pools are shared by all of the communicator's object adapters. If necessary, you can configure individual object adapters to use a private thread pool instead.

If a thread pool is exhausted because all threads are currently dispatching a request, additional incoming requests are transparently delayed until a request completes and relinquishes its thread; that thread is then used to dispatch the next pending request. Ice minimizes thread context switches in a thread pool by using a leader-follower implementation (see [17]).

Thread Pool Configuration

Configuration properties determine the minimum and maximum size of a thread pool:

- `name.Size`

This property specifies the initial and minimum size of the thread pool. If not defined, the default value is one.

- `name.SizeMax`

This property specifies the maximum size of the thread pool. As the demand for threads increases, the Ice run time adds more threads to the pool, up to the maximum size. If not defined, the default value is one.

If `name.SizeMax` is less than `name.Size`, `name.SizeMax` is adjusted to be equal to `name.Size`.

Threads are terminated automatically when they have been idle for a while, but a thread pool always contains at least the minimum number of threads.

For configuration purposes, the names of the default client and server thread pools are `Ice.ThreadPool.Client` and `Ice.ThreadPool.Server`, respectively. As an example, the following properties establish minimum and maximum sizes for the thread pools:

```
Ice.ThreadPool.Client.Size=1
Ice.ThreadPool.Client.SizeMax=10
Ice.ThreadPool.Server.Size=1
Ice.ThreadPool.Server.SizeMax=10
```

Thread pools also support two other properties:

- `name.SizeWarn`

This property sets a high water mark; when the number of threads in a pool reaches this value, the Ice run time logs a warning message. If you see this warning message frequently, it could indicate that you need to increase the value of `name.SizeMax`. If not defined, the default value is 80% of the value of `name.SizeMax`. Set this property to zero to disable the warning.

- `name.StackSize`

This property specifies the number of bytes to use as the stack size of threads in the thread pool. The operating system's default is used if this property is not defined or is set to zero. Only the C++ run time uses this property.

Adapter Thread Pools

Configuring a private thread pool for an adapter is useful in avoiding deadlocks due to thread starvation by ensuring that a minimum number of threads is available for dispatching requests to certain servants.

You configure an object adapter to use a private thread pool by defining at least one of the following properties with a value greater than zero:

- `adapter.ThreadPool.Size`
- `adapter.ThreadPool.SizeMax`

These properties have the same purpose as those described earlier, but they both have a default value of zero. If neither property is defined, the adapter uses the communicator's thread pools by default. If `SizeMax` is not defined, it defaults to the value of `Size`, meaning the thread pool does not grow dynamically.

Object adapter thread pools also support the `SizeWarn` and `StackSize` properties described in the previous subsection.

As an example, the properties shown below configure a thread pool for the object adapter named `PrinterAdapter`:

```
PrinterAdapter.ThreadPool.Size=3
PrinterAdapter.ThreadPool.SizeMax=15
PrinterAdapter.ThreadPool.SizeWarn=14
PrinterAdapter.ThreadPool.StackSize=262144
```

Size Considerations

Choosing an inappropriate size for a thread pool can have a serious impact on the performance of your application. Since the client and server thread pools each contain only one thread by default, it is important that you understand the implications of using them in their default configurations:

- Only one operation can be dispatched at a time.
This can be convenient because it lets you avoid (or postpone) dealing with thread-safety issues in your application (see Section 31.9.5), but it also limits throughput. Be aware that this limitation applies to all of the object adapters that share the default thread pools.
- Only one AMI reply can be processed at a time.
An application must increase the size of the client thread pool in order to process multiple AMI callbacks in parallel.
- Nested twoway invocations are limited.
At most one level of nested twoway invocations is possible. (See Section 31.9.4.)

31.9.2 Thread-Per-Connection

The thread-per-connection concurrency model creates a separate thread for each incoming and outgoing connection. The thread for an incoming connection dispatches requests and, if the connection is bidirectional, handles replies to outgoing bidirectional requests. The thread for an outgoing connection processes replies and, if the connection is bidirectional, dispatches incoming requests.

Two configuration properties are supported for thread-per-connection:

- `Ice.ThreadPerConnection`
This property enables thread-per-connection if its value is greater than zero.
- `Ice.ThreadPerConnection.StackSize`
This property specifies the number of bytes to use as the stack size of each thread. The operating system's default is used if this property is not defined or is set to zero. Only the C++ run time uses this property.

It is not possible to use both concurrency models in the same communicator. If thread-per-connection is enabled for a communicator, no thread pools are created and all thread pool-related configuration properties are ignored. An application that needs to use both concurrency models can create multiple communicators with the desired configurations.

31.9.3 Comparing Concurrency Models

Thread pool is the default concurrency model because it is an appropriate choice for most applications. Thread-per-connection is useful in certain situations and

mandatory in others, such as when using IceSSL for Java (see Chapter 40). This section discusses some issues to consider when deciding which concurrency model is appropriate for your application.

Scalability

Since thread-per-connection creates a new thread for each connection, a program that establishes hundreds of connections also creates hundreds of threads. The use of active connection management (see Section 35.4) to reap idle connections (and therefore the threads associated with them) can mitigate this somewhat, but thread-per-connection does not scale as well as a thread pool. In fact, the ability to set the maximum size of a thread pool allows you to tune an Ice application to match the hardware capabilities of its host. On a multi-processor machine, for example, you may decide to limit the thread pool to the number of physical processors in order to minimize the overhead of thread context switches.

Concurrency

The thread-per-connection model is useful when you need to serialize requests from a client. For instance, suppose that a transaction processing server must ensure that requests are dispatched in the order they are received. If the thread-per-connection model is enabled, only one thread can dispatch the requests received on a connection, and therefore serialization is guaranteed (assuming the client is not sending requests on multiple connections).

This requirement could also be satisfied with a thread pool, but only if you limit the maximum size of the thread pool to one or, alternatively, if you can guarantee that the client does not send requests from multiple threads and does not send oneway requests. The disadvantage of using a thread pool with only one thread is that it serializes requests from all clients, rather than just the requests from a single connection. If you use a larger thread pool, and the client sends requests from multiple threads or uses oneway requests, then the operating system's thread scheduling behavior in the server could cause requests to be dispatched out of order (see Section 31.13).

The fact that thread-per-connection serializes requests could just as easily be considered a disadvantage in a use case with different requirements. For example, thread-per-connection might be an inappropriate choice for a server with long-running operations when the client needs the ability to have several operations in progress simultaneously. There are ways to achieve the client's concurrency requirements while using the thread-per-connection model. One option is to design the client so that it forces new connections to be established (see

Section 35.3), however this tightly couples the client with the server implementation. Another alternative is for the server to use asynchronous dispatch in order to avoid blocking the connection's thread, and use a work queue to execute the requests in separate threads. However, unless the server needs to track the order of requests, a thread pool provides similar functionality with less effort.

31.9.4 Nested Invocations

A *nested invocation* is one that is made within the context of another Ice operation. For instance, the implementation of an operation in a servant might need to make a nested invocation on some other object, or an AMI callback object might invoke an operation in the course of processing a reply to an asynchronous request. It is also possible for one of these invocations to result in a nested callback to the originating process. The maximum depth of such invocations is determined by the concurrency models in use by the communicating parties.

Deadlocks

Applications that use nested invocations must be carefully designed to avoid the potential for deadlock, which can easily occur when invocations take a circular path. For example, Figure 31.5 presents a deadlock scenario when using the default thread pool configuration.

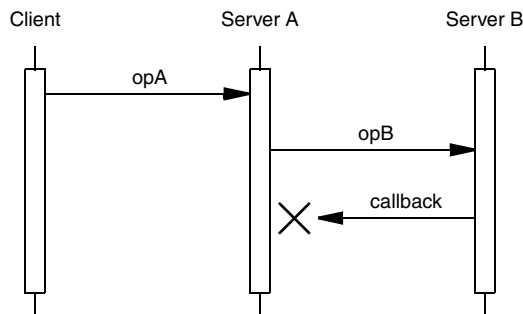

Figure 31.5. Nested invocation deadlock.

In this diagram, the implementation of *opA* makes a nested twoway invocation of *opB*, but the implementation of *opB* causes a deadlock when it tries to make a nested callback. As mentioned in Section 31.9.1, the default thread pools have a maximum size of one thread unless explicitly configured otherwise. In Server A,

the only thread in the server thread pool is busy waiting for its invocation of opB to complete, and therefore no threads remain to handle the callback from Server B. The client is now blocked because Server A is blocked, and they remain blocked indefinitely unless timeouts are used.

There are several ways to avoid a deadlock in this scenario:

- Increase the maximum size of the server thread pool in Server A.

Configuring the server thread pool in Server A to support more than one thread allows the nested callback to proceed. This is the simplest solution, but it requires that you know in advance how deeply nested the invocations may occur, or that you set the maximum size to a sufficiently large value that exhausting the pool becomes unlikely. For example, setting the maximum size to two avoids a deadlock when a single client is involved, but a deadlock could easily occur again if multiple clients invoke opA simultaneously.

- Use a oneway invocation.

If Server A called opB using a oneway invocation, it would no longer need to wait for a response and therefore opA could complete, making a thread available to handle the callback from Server B. However, we have made a significant change in the semantics of opA because now there is no guarantee that opB has completed before opA returns, and it is still possible for the oneway invocation of opB to block (see Section 31.13).

- Implement opA using asynchronous dispatch and invocation.

By declaring opA as an AMD operation (see Section 32.4) and invoking opB using AMI, Server A can usually avoid blocking the thread pool's thread while it waits for opB to complete. As with oneway invocations, however, the asynchronous invocation of opB can block the calling thread if network buffers fill up.

- Create another object adapter for the callbacks.

No deadlock occurs if the callback from Server B is directed to a different object adapter that is configured with its own thread pool.

- Use thread-per-connection.

To invoke the callback, Server B establishes a connection to Server A and therefore a new thread is created to dispatch the request. The limitations of thread-per-connection are discussed in Section 31.9.3.

As another example, consider a client that makes a nested invocation from an AMI callback object using the default thread pool configuration. The (one and only) thread in the client thread pool receives the reply to the asynchronous request and

invokes its callback object. If the callback object in turn makes a nested twoway invocation, a deadlock occurs because no more threads are available in the client thread pool to process its reply. The solutions are similar to some of those presented for Figure 31.5: increase the maximum size of the client thread pool, use a oneway invocation, or call the nested invocation using AMI. The use of thread-per-connection might also solve this deadlock, but only if the nested invocation is sent over a different connection.

Analyzing an Application

A number of factors must be considered when evaluating whether an application is properly designed and configured for nested invocations:

- The concurrency models in use by all communicating parties have a significant impact on an application's ability to use nested invocations. While analyzing the path of circular invocations, you must pay careful attention to the threads involved to determine whether sufficient threads are available to avoid deadlock. This includes not just the threads that dispatch requests, but also the threads that make the requests and process the replies.
- Bidirectional connections are another complication, since you must be aware of which threads are used on either end of the connection.
- Finally, the synchronization activities of the communicating parties must also be scrutinized. For example, a deadlock is much more likely when a lock is held while making an invocation.

As you can imagine, tracing the call flow of a distributed application to ensure there is no possibility of deadlock can quickly become a complex and tedious process. In general, it is best to avoid circular invocations if at all possible.

31.9.5 Thread Safety

The Ice run time itself is fully thread safe, meaning multiple application threads can safely call methods on objects such as communicators, object adapters, and proxies without synchronization problems. As a developer, you must also be concerned with thread safety because the Ice run time can dispatch multiple invocations concurrently in a server. In fact, it is possible for multiple requests to proceed in parallel within the same servant and within the same operation on that servant. It follows that, if the operation implementation manipulates non-stack storage (such as member variables of the servant or global or static data), you must interlock access to this data to avoid data corruption.

The need for thread safety in an application depends on its chosen concurrency model. Using the default thread pool configuration typically makes synchronization unnecessary because at most one operation can be dispatched at a time. Thread safety becomes an issue once you increase the maximum size of a thread pool, or use thread-per-connection.

Ice uses the native synchronization and threading primitives of each platform. For C++ users, Ice provides a collection of convenient and portable wrapper classes for use by Ice applications (see Chapter 30) .

Marshaling Issues

The marshaling semantics of the Ice run time present a subtle thread safety issue that arises when an operation returns data by reference. In C++, the only relevant case is returning an instance of a Slice class, either directly or nested as a member of another type. In Java, C#, Visual Basic and Python, Slice structures, sequences, and dictionaries are also affected.

The potential for corruption occurs whenever a servant returns data by reference, yet continues to hold a reference to that data. For example, consider the following Java implementation:

```
public class GridI extends _GridDisp
{
    GridI()
    {
        _grid = // ...
    }

    public int[] []
    getGrid(Ice.Current curr)
    {
        return _grid;
    }

    public void
    setValue(int x, int y, int val, Ice.Current curr)
    {
        _grid[x][y] = val;
    }

    private int[] [] _grid;
}
```

Suppose that a client invoked the `getGrid` operation. While the Ice run time marshals the returned array in preparation to send a reply message, it is possible

for another thread to dispatch the `setValue` operation on the same servant. This race condition can result in several unexpected outcomes, including a failure during marshaling or inconsistent data in the reply to `getGrid`. Synchronizing the `getGrid` and `setValue` operations would not fix the race condition because the Ice run time performs its marshaling outside of this synchronization.

One solution is to implement accessor operations, such as `getGrid`, so that they return copies of any data that might change. There are several drawbacks to this approach:

- Excessive copying can have an adverse affect on performance.
- The operations must return deep copies in order to avoid similar problems with nested values.
- The code to create deep copies is tedious and error-prone to write.

Another solution is to make copies of the affected data only when it is modified. In the revised code shown below, `setValue` replaces `_grid` with a copy that contains the new element, leaving the previous contents of `_grid` unchanged:

```
public class GridI extends _GridDisp
{
    ...

    public synchronized int[] []
    getGrid(Ice.Current curr)
    {
        return _grid;
    }

    public synchronized void
    setValue(int x, int y, int val, Ice.Current curr)
    {
        int[] [] newGrid = // shallow copy...
        newGrid[x][y] = val;
        _grid = newGrid;
    }

    ...
}
```

This allows the Ice run time to safely marshal the return value of `getGrid` because the array is never modified again. For applications where data is read more often than it is written, this solution is more efficient than the previous one because accessor operations do not need to make copies. Furthermore, intelligent use of shallow copying can minimize the overhead in mutating operations.

Finally, a third approach changes accessor operations to use AMD (see Section 32.4) in order to regain control over marshaling. After annotating the `getGrid` operation with `amd` metadata, we can revise the servant as follows:

```
public class GridI extends _GridDisp
{
    ...

    public synchronized void
    getGrid_async(AMD_Grid_getGrid cb, Ice.Current curr)
    {
        cb.ice_response(_grid);
    }

    public synchronized void
    setValue(int x, int y, int val, Ice.Current curr)
    {
        _grid[x][y] = val;
    }

    ...
}
```

Normally, AMD is used in situations where the servant needs to delay its response to the client without blocking the calling thread. For `getGrid`, that is not the goal; instead, as a side-effect, AMD provides the desired marshaling behavior. Specifically, the Ice run time marshals the reply to an asynchronous request at the time the servant invokes `ice_response` on the AMD callback object. Because `getGrid` and `setValue` are synchronized, this guarantees that the data remains in a consistent state during marshaling.

Thread Creation and Destruction Hooks

On occasion, it is necessary to intercept the creation and destruction of threads created by the Ice run time, for example, to interoperate with libraries that require applications to make thread-specific initialization and finalization calls (such as COM's `CoInitializeEx` and `CoUninitialize`). Ice provides callbacks to inform an application when each run-time thread is created and destroyed. For C++, the callback class looks as follows:⁸

8. See below for other languages.

```

class ThreadNotification : public IceUtil::Shared {
public:
    virtual void start() = 0;
    virtual void stop() = 0;
};
typedef IceUtil::Handle<ThreadNotification> ThreadNotificationPtr;

```

To receive notification of thread creation and destruction, you must derive a class from `ThreadNotification` and implement the `start` and `stop` member functions. These functions will be called by the Ice run by each thread as soon as it is created, and just before it exits. You must install your callback class in the Ice run time when you create a communicator by setting the `threadHook` member of the `InitializationData` structure (see Section 31.3).

For example, you could define a callback class and register it with the Ice run time as follows:

```

class MyHook : public virtual Ice::ThreadNotification {
public:
    void start()
    {
        cout << "start: id = " << ThreadControl().id() << endl;
    }
    void stop()
    {
        cout << "stop: id = " << ThreadControl().id() << endl;
    }
};

int
main(int argc, char* argv[])
{
    // ...

    Ice::InitializationData id;
    id.threadHook = new MyHook;
    communicator = Ice::initialize(argc, argv, id);

    // ...
}

```

The implementation of your `start` and `stop` methods can make whatever thread-specific calls are required by your application.

For Java and C#, `Ice.ThreadNotification` is an interface:

```
public interface ThreadNotification {
    void start();
    void stop();
}
```

To receive the thread creation and destruction callbacks, you must derive a class from this interface that implements the `start` and `stop` methods, and register an instance of that class when you create the communicator. (The code to do this is analogous to the C++ version.)

31.10 Proxies

The introduction to proxies provided in Section 2.2.2 describes a proxy as a local artifact that makes a remote invocation as easy to use as a regular function call. In fact, processing remote invocations is just one of a proxy's many responsibilities. A proxy also encapsulates the information necessary to contact the object, including its identity (see Section 31.5) and addressing details such as endpoints (see Section 31.10.2). Proxy methods provide access to configuration and connection information, and act as factories for creating new proxies (see Section 31.10.1). Finally, a proxy initiates the establishment of a new connection when necessary (see Section 35.3).

31.10.1 Proxy Methods

Although the core proxy functionality is supplied by a language-specific base class, we can describe the proxy methods in terms of Slice operations as shown below:

```
bool ice_isA(string id);
void ice_ping();
StringSeq ice_ids();
string ice_id();
int ice_getHash();
Communicator ice_getCommunicator();
string ice_toString();
Object* ice_identity(Identity id);
Identity ice_getIdentity();
Object* ice_adapterId(string id);
string ice_getAdapterId();
Object* ice_endpoints(EndpointSeq endpoints);
EndpointSeq ice_getEndpoints();
```

```
Object* ice_endpointSelection(EndpointSelectionType t);
EndpointSelectionType ice_getEndpointSelection();
Object* ice_context(Context ctx);
Context ice_getContext();
Object* ice_defaultContext();
Object* ice_facet(string facet);
string ice_getFacet();
Object* ice_twoway();
bool ice_isTwoway();
Object* ice_oneway();
bool ice_isOneway();
Object* ice_batchOneway();
bool ice_isBatchOneway();
Object* ice_datagram();
bool ice_isDatagram();
Object* ice_batchDatagram();
bool ice_isBatchDatagram();
Object* ice_secure(bool b);
bool ice_isSecure();
Object* ice_compress(bool b);
Object* ice_timeout(int timeout);
Object* ice_router(Router* rtr);
Router* ice_getRouter();
Object* ice_locator(Locator* loc);
Locator* ice_getLocator();
Object* ice_locatorCacheTimeout(int seconds);
int ice_getLocatorCacheTimeout();
Object* ice_collocationOptimized(bool b);
bool ice_isCollocationOptimized();
Object* ice_connectionId(string id);
Connection ice_getConnection();
Object* ice_connectionCached(bool b);
bool ice_isConnectionCached();
```

These methods can be categorized as follows:

- Remote inspection: methods that return information about the remote object. These methods make remote invocations and therefore accept an optional trailing argument of type `Ice::Context` (see Section 31.11).
- Local inspection: methods that return information about the proxy's local configuration.
- Factory: methods that return new proxy instances configured with different features.

Proxies are immutable, so factory methods allow an application to obtain a new proxy with the desired configuration. Factory methods essentially clone the original proxy and modify one or more features of the new proxy.

The core proxy methods are explained in greater detail in Table 31.1.

Table 31.1. The semantics of core proxy methods.

Method	Description	Remote
<code>ice_isA</code>	Returns <code>true</code> if the remote object supports the type indicated by the <code>id</code> argument, otherwise <code>false</code> . This method can only be invoked on a twoway proxy.	Yes
<code>ice_ping</code>	Determines whether the remote object is reachable. Does not return a value.	Yes
<code>ice_ids</code>	Returns the type ids of the types supported by the remote object. The return value is an array of strings. This method can only be invoked on a twoway proxy.	Yes
<code>ice_id</code>	Returns the type id of the most-derived type supported by the remote object. This method can only be invoked on a twoway proxy.	Yes
<code>ice_getHash</code>	Returns a hash value for the proxy	No
<code>ice_getCommunicator</code>	Returns the communicator that was used to create this proxy.	No
<code>ice_toString</code>	Returns the string representation of the proxy.	No
<code>ice_identity</code>	Returns a new proxy having the given identity.	No
<code>ice_getIdentity</code>	Returns the identity of the Ice object represented by the proxy.	No
<code>ice_adapterId</code>	Returns a new proxy having the given adapter id.	No
<code>ice_getAdapterId</code>	Returns the proxy's adapter id, or an empty string if no adapter id is configured.	No

Table 31.1. The semantics of core proxy methods.

Method	Description	Remote
<code>ice_endpoints</code>	Returns a new proxy having the given endpoints.	No
<code>ice_getEndpoints</code>	Returns a sequence of <code>Endpoint</code> objects representing the proxy's endpoints.	No
<code>ice_endpointSelection</code>	Returns a new proxy having the given selection policy (random or ordered). See Section 35.3.1 for more information.	No
<code>ice_getEndpointSelection</code>	Returns the endpoint selection policy for the proxy.	No
<code>ice_context</code>	Returns a new proxy having the given request context. See Section 31.11 for more information on request contexts.	No
<code>ice_getContext</code>	Returns the request context associated with the proxy. See Section 31.11 for more information on request contexts.	No
<code>ice_defaultContext</code>	Returns a new proxy having the default request context. See Section 31.11 for more information on request contexts.	No
<code>ice_facet</code>	Returns a new proxy having the given facet name. See Chapter 33 for more information on facets.	No
<code>ice_getFacet</code>	Returns the name of the facet associated with the proxy, or an empty string if no facet has been set. See Chapter 33 for more information on facets.	No
<code>ice_twoway</code>	Returns a new proxy for making twoway invocations.	No
<code>ice_isTwoway</code>	Returns <code>true</code> if the proxy uses twoway invocations, otherwise <code>false</code> .	No
<code>ice_oneway</code>	Returns a new proxy for making oneway invocations (see Section 31.13).	No

Table 31.1. The semantics of core proxy methods.

Method	Description	Remote
<code>ice_isOneway</code>	Returns <code>true</code> if the proxy uses oneway invocations, otherwise <code>false</code> .	No
<code>ice_batchOneway</code>	Returns a new proxy for making batch oneway invocations (see Section 31.15).	No
<code>ice_isBatchOneway</code>	Returns <code>true</code> if the proxy uses batch oneway invocations, otherwise <code>false</code> .	No
<code>ice_datagram</code>	Returns a new proxy for making datagram invocations (see Section 31.14).	No
<code>ice_isDatagram</code>	Returns <code>true</code> if the proxy uses datagram invocations, otherwise <code>false</code> .	No
<code>ice_batchDatagram</code>	Returns a new proxy for making batch datagram invocations (see Section 31.15).	No
<code>ice_isBatchDatagram</code>	Returns <code>true</code> if the proxy uses batch datagram invocations, otherwise <code>false</code> .	No
<code>ice_secure</code>	Returns a new proxy whose endpoints may be filtered depending on the boolean argument. If <code>true</code> , only endpoints using secure transports are allowed, otherwise all endpoints are allowed.	No
<code>ice_isSecure</code>	Returns <code>true</code> if the proxy uses only secure endpoints, otherwise <code>false</code> .	No
<code>ice_compress</code>	Returns a new proxy whose protocol compression capability is determined by the boolean argument. If <code>true</code> , the proxy uses protocol compression if it is supported by the endpoint. If <code>false</code> , protocol compression is never used.	No

Table 31.1. The semantics of core proxy methods.

Method	Description	Remote
<code>ice_timeout</code>	Returns a new proxy with the given timeout value in milliseconds. A value of -1 disables timeouts. See Section 31.12 for more information on timeouts.	No
<code>ice_router</code>	Returns a new proxy configured with the given router proxy. See Chapter 41 for more information on routers.	No
<code>ice_getRouter</code>	Returns the router that is configured for the proxy (nil if no router is configured).	No
<code>ice_locator</code>	Returns a new proxy configured with the given locator proxy. See Chapter 37 for more information on locators.	No
<code>ice_getLocator</code>	Returns the locator that is configured for the proxy (nil if no locator is configured).	No
<code>ice_locatorCacheTimeout</code>	For indirect proxies, returns a new proxy with the specified timeout. For direct and fixed proxies, the operation is a no-op and returns the same proxy that was passed to the operation.	No
<code>ice_getLocatorCacheTimeout</code>	Returns the locator cache timeout value in seconds. For direct and fixed reference, this operation always returns zero.	No
<code>ice_collocationOptimized</code>	Returns a new proxy configured for collocation optimization. If <code>true</code> , collocated optimizations are enabled. The default value is <code>true</code> . For AMI invocations, the optimization setting is ignored—AMI invocations implicitly disable the collocation optimization.	No
<code>ice_isCollocationOptimized</code>	Returns <code>true</code> if the proxy uses collocation optimization, otherwise <code>false</code> .	No

Table 31.1. The semantics of core proxy methods.

Method	Description	Remote
<code>ice_connectionId</code>	Returns a new proxy having the given connection identifier. See Section 35.3.3 for more information.	No
<code>ice_getConnection</code>	Returns an object representing the connection used by the proxy. See Section 35.5 for more information.	No
<code>ice_connectionCached</code>	Enables or disables connection caching for the proxy. See Section 35.3.4 for more information	No
<code>ice_isConnectionCached</code>	Returns <code>true</code> if the proxy uses connection caching, otherwise <code>false</code> .	No

31.10.2 Endpoints

Proxy endpoints are the client-side equivalent of object adapter endpoints (see Section 31.4.6). A proxy endpoint identifies the protocol information used to contact a remote object, as shown in the following example:

```
tcp -h www.zeroc.com -p 10000
```

This endpoint states that an object is reachable via TCP on the host `www.zeroc.com` and the port `10000`.

A proxy must have, or be able to obtain, at least one endpoint in order to be useful. As defined in Section 2.2.2, a *direct proxy* contains one or more endpoints:

```
MyObject:tcp -h www.zeroc.com -p 10000:ssl -h www.zeroc.com -p 10001
```

In this example the object with the identity `MyObject` is available at two separate endpoints, one using TCP and the other using SSL.

If a stringified proxy does not contain the `-h` option (that is, not host is specified), invocations on the proxy attempt to locate the server using the hostname returned by `gethostname`.

An *indirect proxy* uses a locator (see Chapter 37) to retrieve the endpoints dynamically. One style of indirect proxy contains an adapter identifier:

MyObject @ MyAdapter

When this proxy requires the endpoints associated with `MyAdapter`, it requests them from the locator.

31.10.3 Endpoint Filtering

A proxy's configuration determines how its endpoints are used. For example, a proxy configured for secure communication will only use endpoints having a secure protocol, such as SSL.

The factory functions described in Table 31.2 allow applications to manipulate endpoints indirectly. Calling one of these functions returns a new proxy whose endpoints have been filtered accordingly.

Table 31.2. Proxy factory functions and their effects on endpoints.

Option	Description
<code>ice_secure</code>	Selects only endpoints using a secure protocol (e.g., SSL).
<code>ice_datagram</code>	Selects only endpoints using a datagram protocol (e.g., UDP).
<code>ice_batchDatagram</code>	Selects only endpoints using a datagram protocol (e.g., UDP).
<code>ice_twoway</code>	Selects only endpoints capable of making twoway invocations (e.g., TCP, SSL). For example, this removes datagram endpoints.
<code>ice_oneway</code>	Selects only endpoints capable of making reliable oneway invocations (e.g., TCP, SSL). For example, this removes datagram endpoints.
<code>ice_batchOneway</code>	Selects only endpoints capable of making reliable oneway batch invocations (e.g., TCP, SSL). For example, this removes datagram endpoints.

After calling a factory function, the remaining endpoints are randomized as a simple form of load balancing. In addition, the endpoints of an insecure proxy⁹ are ordered such that insecure endpoints appear before secure endpoints. Since an

attempt to establish a connection tries the endpoints in the order they appear in the proxy, this effectively means that insecure endpoints are tried before secure endpoints.

No exception is raised if a factory function results in a proxy containing no endpoints. Rather, the Ice run time returns a `NoEndpointException` when connection establishment (see Section 35.3) is attempted for such a proxy.

An application can also create a proxy with a specific set of endpoints using the `ice_endpoints` factory function, whose only argument is a sequence of `Ice::Endpoint` objects. At present, an application is not able to create new instances of `Ice::Endpoint`, but rather can only incorporate instances obtained by calling `ice_getEndpoints` on a proxy. Note that `ice_getEndpoints` may return an empty sequence if the proxy has no endpoints, as is the case with an indirect proxy.

31.11 The Ice::Context Parameter

In Sections 6.11.1 and 10.11.1, methods on a proxy are overloaded with a trailing parameter of type `const Ice::Context &` (C++), `java.util.Map` (Java), or `Ice.Context` (C# and VB). The Slice definition of this parameter is as follows:

```
module Ice {
    local dictionary<string, string> Context;
};
```

As you can see, a context is a dictionary that maps strings to strings or, conceptually, a context is a collection of name–value pairs. The contents of this dictionary (if any) are implicitly marshaled with every request to the server, that is, if the client populates a context with a number of name–value pairs and uses that context for an invocation, the name–value pairs that are sent by the client are available to the server.

On the server side, the operation implementation can access the received `Context` via the `ctx` member of the `Ice::Current` parameter (see Section 31.6) and extract the name–value pairs that were sent by the client.

9. An insecure proxy is one that has not been explicitly configured as secure. Proxies are insecure by default, and can be configured for secure invocations by calling `ice_secure(true)`.

31.11.1 Passing Context Explicitly

Contexts provide a means of sending an unlimited number of parameters from client to server without having to mention these parameters in the signature of an operation. For example, consider the following definition:

```
struct Address {
    // ...
};

interface Person {
    string setAddress(Address a);
    // ...
};
```

Assuming that the client has a proxy to a Person object, it could do something along the following lines:

```
PersonPrx p = ...;
Address a = ...;

Ice::Context ctx;
ctx["write policy"] = "immediate";

p->setAddress(a, ctx);
```

In Java, the same code would look as follows:

```
PersonPrx p = ...;
Address a = ...;

java.util.Map ctx = new java.util.HashMap();
ctx.put("write policy", "immediate");

p.setAddress(a, ctx);
```

In C#, the code is almost identical:

```
PersonPrx p = ...;
Address a = ...;

Ice.Context ctx = new Ice.Context();
ctx["write policy"] = "immediate";

p.setAddress(a, ctx);
```

On the server side, we can extract the policy value set by the client to influence how the implementation of `setAddress` works. A C++ implementation might look like:

```
void
PersonI::setAddress(const Address& a, const Ice::Current& c)
{
    Ice::Context::const_iterator i = c.ctx.find("write policy");
    if (i != c.ctx.end() && i->second == "immediate") {

        // Update the address details and write through to the
        // data base immediately...

    } else {

        // Write policy was not set (or had a bad value), use
        // some other database write strategy.

    }
}
```

For this example, the server examines the value of the context with the key "write policy" and, if that value is "immediate", writes the update sent by the client straight away; if the write policy is not set or contains a value that is not recognized, the server presumably applies a more lenient write policy (such as caching the update in memory and writing it later). The Java version of the operation implementation is essentially identical, so we do not show it here.

31.11.2 Passing Context Implicitly

Instead of passing a context explicitly with an invocation, you can also use an *implicit* context. Implicit contexts allow you to set a context on a particular proxy once and, thereafter, whenever you use that proxy to invoke an operation, the previously-set context is sent with each invocation. The proxy base class provides a member function, `ice_context`, to do this:

```
namespace IceProxy {
    namespace Ice {
        class Object : /* ... */ {
        public:
            Ice::ObjectPrx
            ice_context(const Ice::Context&) const;
        };
    };
}
```

```

        }; // ...
    };
}

```

For Java, the corresponding function is:

```

package Ice;

public interface ObjectPrx {
    ObjectPrx ice_context(java.util.Map newContext);
    // ...
}

```

For C#, the corresponding method is:

```

namespace Ice
{
    public interface ObjectPrx
    {
        ObjectPrx ice_context(Context newContext);
        // ...
    }
}

```

`ice_context` creates a new proxy that implicitly stores the passed context. Note that the return type of `ice_context` is `ObjectPrx`, that is, before you can use the newly-created proxy, you must down-cast it to the correct type. For example, in C++:

```

Ice::Context ctx;
ctx["write policy"] = "immediate";

PersonPrx p1 = ...;
PersonPrx p2 = PersonPrx::uncheckedCast(p1->ice_context(ctx));

Address a = ...;

p1->setAddress(a); // Sends no context

p2->setAddress(a); // Sends ctx implicitly

Ice::Context ctx2;
ctx2["write policy"] = "delayed";

p2->setAddress(a, ctx2); // Sends ctx2

```

As the example illustrates, once we have created the p2 proxy, any invocation via p2 implicitly sends the previously-set context. The final line of the example illustrates that it is possible to explicitly send a context for an invocation even if the proxy has an implicit context—an explicit context always overrides any implicit context.

31.11.3 Retrieving Implicit Context

You can retrieve the implicit context of a proxy by calling `ice_getContext`. The call returns the currently-set context of the proxy. (If a proxy has no implicit context, the returned dictionary is empty.) For C++, the signature is:

```
namespace IceProxy {
    namespace Ice {
        class Object : /* ... */ {
        public:
            Ice::Context ice_getContext() const;
            // ...
        };
    }
}
```

For Java, the signature is:

```
package Ice;

public interface ObjectPrx {
    java.util.Map ice_getContext();
    // ...
}
```

For C#, the signature is:

```
namespace Ice
{
    public interface ObjectPrx
    {
        Context ice_getContext();
    }
}
```

31.11.4 Default Contexts

In addition to the explicit and implicit context passed we described in the preceding sections, you can also establish a default context on a communicator

when you create the communicator with `initialize` (see Section 31.3). Thereafter, all proxies obtained via that communicator send the default context of the communicator (provided you have not set an implicit context on a proxy and you are not passing an explicit context). The communicator provides a `getDefaultContext` operation that allows you to retrieve the default context. (If you do not set a context on the communicator, this operation returns an empty dictionary.):

```
module Ice {
    local interface Communicator
    {
        nonmutating Context getDefaultContext();

        // ...
    };
};
```

Here is an example that illustrates this:

```
Ice::InitializationData id;
id.defaultContext["write policy"] = "immediate";
Ice::CommunicatorPtr ic = initialize(id);

Address a = ...;
PersonPrx p1 = ...;

Ice.Context ctx;
ctx["write policy"] = "cached";
PersonPrx p2 = PersonPrx::uncheckedCast(p1->ice_context(ctx));

ctx.clear();
PersonPrx p3 = PersonPrx::uncheckedCast(p2->ice_context(ctx));

p1->setAddress(a); // Sends immediate write policy
p2->setAddress(a); // Sends cached write policy
p3->setAddress(a); // Sends an empty context
```

Here, `p1` uses the default context established on the communicator, whereas `p2` uses an implicit context. Also note that `p3` sends an empty context, *not* the default context established for the communicator. This makes sense: an empty implicit context is no different from a non-empty implicit context, so the implicit context still overrides the default context, even when it is empty.

If you want to create a proxy that sends the default context from a proxy that has an implicit context, you can use the `ice_defaultContext` method on the proxy:

```
Ice::InitializationData id;
id.defaultContext["write policy"] = "immediate";
Ice::CommunicatorPtr ic = initialize(id);

Address a = ...;
PersonPrx p1 = ...;

ctx["write policy"] = "cached";
PersonPrx p2 = PersonPrx::uncheckedCast(p1->ice_context(ctx));

ctx.clear();
PersonPrx p3 = PersonPrx::uncheckedCast(p2->ice_context(ctx));

PersonPrx p4 = PersonPrx::uncheckedCast(p2->ice_defaultContext());

p1->setAddress(a); // Sends immediate write policy
p2->setAddress(a); // Sends cached write policy
p3->setAddress(a); // Sends an empty context
p4->setAddress(a); // Sends immediate write policy
```

In this example, p1 and p4 both use the default context of the communicator.

31.11.5 Context Use Cases

The purpose of Ice::Context is to permit services to be added to Ice that require some contextual information with every request. Such contextual information can be used by services such as a transaction service (to provide the context of a currently established transaction) or a security service (to provide an authorization token to the server). IceStorm (see Chapter 43) uses the context to provide an optional `cost` parameter to the service that influences how the service propagates messages to down-stream subscribers.

In general, services that require such contextual information can be implemented much more elegantly using contexts because this hides explicit Slice parameters that would otherwise have to be supplied by the application programmer with every call.

In addition, contexts, because they are optional, permit a single Slice definition to apply to implementations that use the context as well as to implementations that do not use it. In this way, to add transactional semantics to an existing service, you do not need to modify the Slice definitions to add extra parameters to all operations. This not only is convenient for clients but also prevents the type system from being split into two halves: without contexts, we would need different Slice

definitions for transactional and non-transactional implementations of what, conceptually, is a single service.

Finally, implicit contexts permit context information to be passed by through intermediate parts of a system without cooperation of those intermediate parts. For example, suppose you set an implicit context on a proxy and then pass that proxy to another system component. When that component uses the proxy to invoke an operation, the implicit context will still be sent. In other words, implicit contexts allow you to transparently propagate information via intermediaries that are ignorant of the presence of any context.

31.11.6 A Word of Warning

Contexts are a powerful mechanism for transparent propagation of context information, *if used correctly*. In particular, you may be tempted to use contexts as a means of versioning an application as it evolves over time. For example, version 2 of your application may accept two parameters on an operation that, in version 1, used to accept only a single parameter. Using contexts, you could supply the second parameter as a name–value pair to the server and avoid changing the Slice definition of the operation in order to maintain backward compatibility.

We *strongly* urge you to resist any temptation to use contexts in this manner. The strategy is fraught with problems:

- Missing context

There is nothing that would compel a client to actually send a context when the server expects to receive a context: if a client forgets to send a context, the server, somehow, has to make do without it (or throw an exception).

- Missing or incorrect keys

Even if the client does send a context, there is no guarantee that it has set the correct key. (For example, a simple spelling error can cause the client to send a value with the wrong key.)

- Incorrect values

The value of a context is a string, but the application data that is to be sent might be a number, or it might be something more complex, such as a structure with several members. This forces you to encode the value into a string and decode the value again on the server side. Such parsing is tedious and error prone, and far less efficient than sending strongly-typed parameters. In addition, the server has to deal with string values that fail to decode correctly (for example, because of a encoding error made by the client).

None of the preceding problems can arise if you use proper Slice parameters: parameters cannot be accidentally omitted and they are strongly typed, making it much less likely for the client to accidentally send a meaningless value.

If you are concerned about how to evolve an application over time without breaking backward compatibility, Ice facets are better suited to this task (see Chapter 33). Contexts are meant to be used to transmit simple tokens (such as a transaction identifier) for services that cannot be reasonably implemented without them; you should restrict your use of contexts to that purpose and resist any temptation to use contexts for any other purpose.

Finally, be aware that, if a request is routed via one or more Ice routers, contexts may be dropped by intermediate routers if they consider them illegal. This means that, in general, you cannot rely on an arbitrary context value that is created by an application to actually still be present when a request arrives at the server—only those context values that are known to routers and that are considered legitimate are passed on. It follows that you should not abuse contexts to pass things that really should be passed as parameters.

31.12 Connection Timeouts

A synchronous remote invocation does not complete on the client side until the server has finished processing it. Occasionally, it is useful to be able to force an invocation to terminate after some time, even if it has not completed. Proxies provide the `ice_timeout` operation for this purpose:

```
namespace IceProxy {
  namespace Ice {
    class Object : /* ... */ {
    public:
      Ice::ObjectPrx ice_timeout(Ice::Int t) const;
      // ...
    };
  }
}
```

For Java (and, analogously, for C#), the corresponding method is:

```

package Ice;

public interface ObjectPrx {
    ObjectPrx ice_timeout(int t);
    // ...
}

```

The `ice_timeout` operation creates a proxy with a timeout from an existing proxy. For example:

```

Filesystem::FilePrx myFile = ...;
Filesystem::FilePrx timeoutFile
    = Filesystem::FilePrx::uncheckedCast(
        myFile->ice_timeout(5000));

try {
    Lines text = timeoutFile->read(); // Read with timeout
} catch(const Ice::TimeoutException&) {
    cerr << "invocation timed out" << endl;
}

Lines text = myFile->read(); // Read without timeout

```

The parameter to `ice_timeout` determines the timeout value in milliseconds. A value of `-1` indicates no timeout. In the preceding example, the timeout is set to five seconds; if an invocation of `read` via the `timeoutFile` proxy does not complete within five seconds, the operation terminates with an `Ice::TimeoutException`. On the other hand, invocations via the `myFile` proxy are unaffected by the timeout, that is, `ice_timeout` sets the timeout on a per-proxy basis.

The timeout value set on a proxy affects all networking operations: reading and writing of data as well as opening and closing of connections. If any of these operations does not complete within the timeout, the client receives an exception. Note that, if the Ice run time encounters a recoverable error condition and transparently retries an invocation, this means that the timeout applies separately to each attempt. Similarly, if a large amount of data is sent with an operation invocation in several `write` system calls, the timeout applies to each write, not to the invocation overall.

Timeouts that expire during reading or writing of data are indicated by a `TimeoutException`. For opening and closing of connections, the Ice run time reserves separate exceptions:

- `ConnectTimeoutException`

This exception indicates that a connection could not be established within the specified time.

- **CloseTimeoutException**

This exception indicates that a connection could not be closed within the specified time.

If no timeout is established for a proxy via `ice_timeout`, the Ice run time uses default values that you can change with the following configuration properties:

- **Ice.Override.ConnectTimeout**

This property defines the default timeout for connection establishment. If not defined, its default value is `-1` (no timeout). If a proxy has multiple endpoints, the timeout applies to each endpoint separately.

- **Ice.Override.Timeout**

This property defines the default timeout for invocations. If no value is defined for **Ice.Override.ConnectTimeout**, the value of **Ice.Override.Timeout** is also used as the timeout for connection establishment. If not defined, the default value is `-1` (no timeout).

Note that timeouts are “soft” timeouts, in the sense that they are not precise, real-time timeouts. (The precision is limited by the capabilities of the underlying operating system.) You should also be aware that timeouts are considered fatal error conditions by the Ice run time and result in connection closure on the client side. Furthermore, any other requests pending on the same connection also fail with an exception. Timeouts are meant to be used to prevent a client from blocking indefinitely in case something has gone wrong with the server; they are not meant as a mechanism to routinely abort requests that take longer than intended.

For information on using timeouts with asynchronous requests, refer to Section 32.3.5.

31.13 Oneway Invocations

As mentioned in Chapter 2, the Ice run time supports *oneway* invocations. A oneway invocation is sent on the client side by writing the request to the client’s local transport buffers; the invocation completes and returns control to the application code as soon as it has been accepted by the local transport. Of course, this means that a oneway invocation is unreliable: it may never be sent (for example, because of a network failure) or it may not be accepted in the server (for example, because the target object does not exist).

This is an issue in particular if you use *active connection management* (see Section 35.4): if a server closes a connection at the wrong moment, it is possible

for the client to lose already-buffered oneway requests. We therefore recommend that you disable active connection management for the server side if clients use oneway (or batched oneway—see Section 31.15) requests. In addition, if clients use oneway requests and your application initiates server shutdown, it is the responsibility of your application to ensure either that it can cope with the potential loss of buffered oneway requests, or that it does not shut down the server at the wrong moment (while clients have still have oneway requests that are buffered, but not yet sent).

If anything goes wrong with a oneway request, the client-side application code does not receive any notification of the failure; the only errors that are reported to the client are local errors that occur on the client side during call invocation (such as failure to establish a connection, for example).

Oneway invocations are received and processed on the server side like any other incoming request. In particular, there is no way for the server-side application code to distinguish a oneway invocation from a twoway invocation, that is, oneway invocation is transparent on the server side.

Oneway invocations do not incur any return traffic from the server to the client: the server never sends a reply message in response to a oneway invocation (see Chapter 34). This means that oneway invocations can result in large efficiency gains, especially for large numbers of small messages, because the client does not have to wait for the reply to each message to arrive before it can send the next message.

In order to be able to invoke an operation as oneway, two conditions must be met:

- The operation must have a `void` return type, must not have any out-parameters, and must not have an exception specification.

This requirement reflects the fact that the server does not send a reply for a oneway invocation to the client: without such a reply, there is no way to return any values or exceptions to the client.

If you attempt to invoke an operation that returns values to the client as a oneway operation, the Ice run time throws a `TwowayOnlyException`.

- The proxy on which the operation is invoked must support a stream-oriented transport (such as TCP or SSL).

Oneway invocations require a stream-oriented transport. (To get something like a oneway invocation for datagram transports, you need to use a datagram invocation—see Section 31.14.)

If you attempt to create a oneway proxy for an object that does not offer a stream-oriented transport, the Ice run time throws a `NoEndpointException`.

Despite their theoretical unreliability, in practice, oneway invocations are reliable (but not infallible [19]): they are sent via a stream-oriented transport, so they cannot get lost except when the connection is shutting down (see Section 35.6.2) or fails entirely. In particular, the transport uses its usual flow control, so the client cannot overrun the server with messages. On the client-side, the Ice run time will block if the client's transport buffers fill up, so the client-side application code cannot overrun its local transport.

Consequently, oneway invocations normally do not block the client-side application code and return immediately, provided that the client does not consistently generate messages faster than the server can process them. If the rate at which the client invokes operations exceeds the rate at which the server can process them, the client-side application code will eventually block in an operation invocation until sufficient room is available in the client's transport buffers to accept the invocation.

Regardless of whether the client exceeds the rate at which the server can process incoming oneway invocations, the execution of oneway invocations in the server proceeds asynchronously: the client's invocation completes before the message even arrives at the server.

One thing you need to keep in mind about oneway invocations is that they may appear to be reordered in the server: because oneway invocations are sent via a stream-oriented transport, they are guaranteed to be received in the order in which they were sent. However, the server's concurrency model may dispatch each invocation in its own thread; because threads are scheduled preemptively, this may cause an invocation sent later by the client to be dispatched and executed before an invocation that was sent earlier.

There are two ways to force oneway requests to be dispatched in the order they were received:

1. Use only one thread in the server thread pool by setting the property `Ice.ThreadPool.Server.SizeMax=1`. Be aware that this configuration could have a serious impact on performance because it serializes all requests.

2. Use the thread-per-connection concurrency model in the server by setting the property `Ice.ThreadPerConnection=1`. This configuration serializes all requests received over the same connection, but also presents a potential scalability issue because a new thread is created for each connection.

For these reasons, oneway invocations are usually best suited to simple updates that are otherwise stateless (that is, do not depend on the surrounding context or the state established by previous invocations). Refer to Section 31.9 for more information on concurrency models and threading.

Creating Oneway Proxies

Ice selects between twoway, oneway, and datagram (see Section 31.14) invocations via the proxy that is used to invoke the operation. By default, all proxies are created as twoway proxies. To invoke an operation as oneway, you must create a separate proxy for oneway dispatch from a twoway proxy.

For C++, all proxies are derived from a common `IceProxy::Ice::Object` class (see Section 6.11.1). The proxy base class contains a method to create a oneway proxy, called `ice_oneway`:

```
namespace IceProxy {
    namespace Ice {
        class Object : /* ... */ {
        public:
            Ice::ObjectPrx ice_oneway() const;
            // ...
        };
    }
}
```

For Java and C#, proxies are derived from the `Ice.ObjectPrx` interface (see Section 10.11.2) and the definition of `ice_oneway` is:

```
package Ice;

public interface ObjectPrx {
    ObjectPrx ice_oneway();
    // ...
}
```

We can call `ice_oneway` to create a oneway proxy and then use the proxy to invoke an operation as follows. (We show the C++ version here—the Java and C# versions are analogous.)

```

Ice::ObjectPrx o = communicator->stringToProxy(/* ... */);

// Get a oneway proxy.
//
Ice::ObjectPrx oneway;
try {
    oneway = o->ice_oneway();
} catch (const Ice::NoEndPointException&) {
    cerr << "No endpoint for oneway invocations" << endl;
}

// Down-cast to actual type.
//
PersonPrx onewayPerson = PersonPrx::uncheckedCast(oneway);

// Invoke an operation as oneway.
//
try {
    onewayPerson->someOp();
} catch (const Ice::TwayOnlyException&) {
    cerr << "someOp() is not oneway" << endl;
}

```

Note that we use an `uncheckedCast` to down-cast the proxy from `ObjectPrx` to `PersonPrx`: for a oneway proxy, we cannot use a `checkedCast` because a `checkedCast` requires a reply from the server but, of course, a oneway proxy does not permit that reply. If instead you want to use a safe down-cast, you can first down-cast the twoway proxy to the actual object type and then obtain the oneway proxy:

```

Ice::ObjectPrx o = communicator->stringToProxy(/* ... */);

// Safe down-cast to actual type.
//
PersonPrx person = PersonPrx::checkedCast(o);

if (person) {
    // Get a oneway proxy.
    //
    PersonPrx onewayPerson;
    try {
        onewayPerson
            = PersonPrx::uncheckedCast(person->ice_oneway());
    } catch (const Ice::NoEndPointException&) {
        cerr << "No endpoint for oneway invocations" << endl;
    }
}

```

```
    }  
  
    // Invoke an operation as oneway.  
    //  
    try {  
        onewayPerson->someOp();  
    } catch (const Ice::TwowayOnlyException&) {  
        cerr << "someOp() is not oneway" << endl;  
    }  
}
```

Note that, while the second version of this code is somewhat safer (because it uses a safe down-cast), it is also slower (because the safe down-cast incurs the cost of an additional twoway message).

31.14 Datagram Invocations

Datagram invocations are the equivalent of oneway invocations for datagram transports. As for oneway invocations, datagram invocations can be sent only for operations that have a `void` return type and do not have out-parameters or an exception specification. (Attempts to use a datagram invocation with an operation that does not meet these criteria result in a `TwowayOnlyException`.) In addition, datagram invocations can only be used if the proxy's endpoints include at least one UDP transport; otherwise, the Ice run time throws a `NoEndpointException`.

The semantics of datagram invocations are similar to oneway invocations: no return traffic flows from the server to the client and proceed asynchronously with respect to the client; a datagram invocation completes as soon as the client's transport has accepted the invocation into its buffers. However, datagram invocations have additional error semantics:

- Individual invocations may be lost or received out of order.

On the wire, datagram invocations are sent as true datagrams, that is, individual datagrams may be lost, or arrive at the server out of order. As a result, not only may operations be dispatched out of order, an individual invocation out of a series of invocations may be lost. (This cannot happen for oneway invocations because, if a connection fails, *all* invocations are lost once the connection breaks down.)

- UDP packets may be duplicated by the transport.

Because of the nature of UDP routing, it is possible for datagrams to arrive in duplicate at the server. This means that, for datagram invocations, Ice does *not* guarantee at-most-once semantics (see page 16): if UDP datagrams are duplicated, the same invocation may be dispatched more than once in the server.

- UDP packets are limited in size.

The maximum size of an IP datagram is 65,535 bytes. Of that, the IP header consumes 20 bytes, and the UDP header consumes 8 bytes, leaving 65,507 bytes as the maximum payload. If the marshaled form of an invocation, including the Ice request header (see Chapter 34) exceeds that size, the invocation is lost. (Exceeding the size limit for a UDP datagram is indicated to the application by a `DatagramLimitException`.)

Because of their unreliable nature, datagram invocations are best suited to simply update messages that are otherwise stateless. In addition, due to the high probability of loss of datagram invocations over wide area networks, you should restrict use of datagram invocations to local area networks, where they are less likely to be lost. (Of course, regardless of the probability of loss, you must design your application such that it can tolerate lost or duplicated messages.)

Creating Datagram Proxies

To create a datagram proxy, you must call `ice_datagram` on the proxy, for example:

```
Ice::ObjectPrx o = communicator->stringToProxy(/* ... */);

// Get a datagram proxy.
//
Ice::ObjectPrx datagram;
try {
    datagram = o->ice_datagram();
} catch (const Ice::NoEndPointException&) {
    cerr << "No endpoint for datagram invocations" << endl;
}

// Down-cast to actual type.
//
PersonPrx datagramPerson = PersonPrx::uncheckedCast(datagram);

// Invoke an operation as a datagram.
//
try {
```

```

        datagramPerson->someOp();
    } catch (const Ice::TwowayOnlyException&) {
        cerr << "someOp() is not oneway" << endl;
    }
}

```

As for the oneway example in Section 31.13, you can choose to first do a safe down-cast to the actual type of interface and then obtain the datagram proxy, rather than relying on an unsafe down-cast, as shown here. However, doing so may be disadvantageous for two reasons:

- Safe down-casts are sent via a stream-oriented transport. This means that using a safe down-cast will result in opening a connection for the sole purpose of verifying that the target object has the correct type. This is expensive if all the other traffic to the object is sent via datagrams.
- If the proxy does not offer a stream-oriented transport, the `checkedCast` fails with a `NoEndpointException`, so you can use this approach only for proxies that offer both a UDP endpoint and a TCP/IP and/or SSL endpoint.

31.15 Batched Invocations

Oneway and datagram invocations are normally sent as a separate message, that is, the Ice run time sends the oneway or datagram invocation to the server immediately, as soon as the client makes the call. If a client sends a number of oneway or datagram invocations in succession, the client-side run time traps into the OS kernel for each message, which is expensive. In addition, each message is sent with its own message header (see Chapter 34), that is, for n messages, the bandwidth for n message headers is consumed. In situations where a client sends a number of oneway or datagram invocations, the additional overhead can be considerable.

To avoid the overhead of sending many small messages, you can send oneway and datagram invocations in a batch: instead of being sent as a separate message, a batch invocation is placed into a client-side buffer by the Ice run time. Successive batch invocations are added to the buffer and accumulated on the client side until the client explicitly flushes them. The relevant APIs are part of the proxy interface:

```

namespace IceProxy {
    namespace Ice {
        class Object : /* ... */ {
        public:

```

```

Ice::ObjectPrx ice_batchOneway() const;
Ice::ObjectPrx ice_batchDatagram() const;
// ...
};
}
}

```

The `ice_batchOneway` and `ice_batchDatagram` methods convert a proxy to a batch proxy. Once you obtain a batch proxy, messages sent via that proxy are buffered in the client-side run time instead of being sent immediately. Once the client has invoked one or more operations on batch proxies, it can explicitly flush the batched invocations by calling `Communicator::flushBatchRequests`:

```

module Ice {
    local interface Communicator {
        void flushBatchRequests();
        // ...
    };
};

```

This causes the batched messages to be sent “in bulk”, preceded by a single message header. On the server side, batched messages are dispatched by a single thread, in the order in which they were written into the batch. This means that messages from a single batch cannot appear to be reordered in the server. Moreover, either all messages in a batch are delivered or none of them. (This is true even for batched datagrams.)

For batched datagram invocations, you need to keep in mind that, if the data for the invocations in a batch substantially exceeds the PDU size of the network, it becomes increasingly likely for an individual UDP packet to get lost due to fragmentation. In turn, loss of even a single packet causes the entire batch to be lost. For this reason, batched datagram invocations are most suitable for simple interfaces with a number of operations that each set an attribute of the target object (or interfaces with similar semantics). (Batched oneway invocations do not suffer from this risk because they are sent over stream-oriented transports, so individual packets cannot be lost.)

Batched invocations are more efficient if you also enable compression for the transport: many isolated and small messages are unlikely to compress well, whereas batched messages are likely to provide better compression because the compression algorithm has more data to work with.¹⁰

As for oneway invocations (see page 877), you should disable server-side active connection management (ACM). With server-side ACM enabled, it is

possible for a server to close the connection at the wrong moment and not process a batch (with no indication being returned to the client that the batch was lost).

31.16 Testing Proxies for Dispatch Type

The proxy interface offers a number of operations that allow you test the dispatch mode of a proxy. (The Java and C# versions of these methods are analogous, so we do not show them here.)

```
namespace IceProxy {
    namespace Ice {
        class Object : /* ... */ {
        public:
            bool ice_isTwoway() const;
            bool ice_isOneway() const;
            bool ice_isDatagram() const;
            bool ice_isBatchOneway() const;
            bool ice_isBatchDatagram() const;
            // ...
        };
    }
}
```

These operations allow you to test the dispatch mode of an individual proxy.

31.17 Location Services

In Section 2.2.2 we described briefly how the Ice run time uses an intermediary, known as a *location service*, to convert the symbolic information in an indirect proxy into an endpoint that it can use to communicate with a server. This section expands on that introduction to explain in more detail how the Ice run time interacts with a location service. You can create your own location service or you can use IceGrid, which is an implementation of a location service and provides many

10. Regardless of whether you used batched messages or not, you should enable compression only on lower-speed links. For high-speed LAN connections, the CPU time spent doing the compression and decompression is typically longer than the time it takes to just transmit the uncompressed data.

other useful features as well (see Chapter 37). Describing how to implement a location service is outside the scope of this book.

31.17.1 Locators

A *locator* is an Ice object that is implemented by a location service. A locator object must support the Slice interface `Ice::Locator`, which defines operations that satisfy the location requirements of the Ice run time. Applications do not normally use these operations directly, but the locator object may support an implementation-specific interface derived from `Ice::Locator` that provides additional functionality. For example, IceGrid's locator object implements the derived interface `IceGrid::Query` (see Section 37.5.5).

31.17.2 Client Semantics

On the first use of an indirect proxy in an application, the Ice run time may issue a remote invocation on the locator object. This activity is transparent to the application, as shown in Figure 31.6.

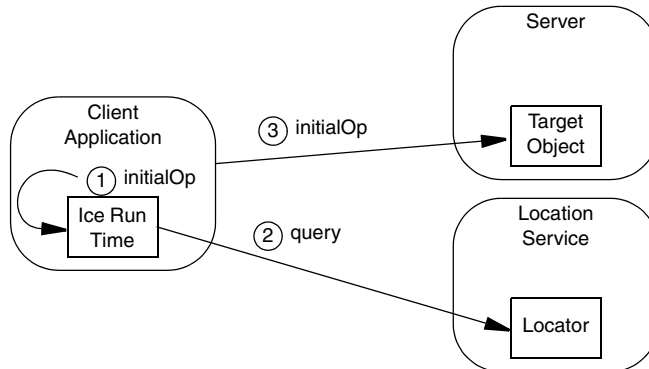

Figure 31.6. Locating an object.

1. The client invokes the operation `initialOp` on an indirect proxy.
2. The Ice run time checks an internal cache to determine whether a query has already been issued for the symbolic information in the proxy. If so, the cached endpoint is used and an invocation on the locator object is avoided. Otherwise, the Ice run time issues a locate request to the locator.

3. If the object is successfully located, its current endpoints are returned, the client establishes a connection to the proper server, and the invocation proceeds as usual. If the object's endpoints cannot be determined, the client application receives an exception. `NotRegisteredException` is raised when an identity, object adapter identifier or replica group identifier is not known. A client may also receive `NoEndpointException` if the location service failed to determine the current endpoints.

As far as the Ice run time is concerned, the locator simply converts the information in an indirect proxy into usable endpoints. Whether the locator's implementation is more sophisticated than a simple lookup table is irrelevant to the Ice run time. However, the act of performing this conversion may have additional semantics that the application must be prepared to accept.

For example, when using IceGrid as your location service, the target server may be launched automatically if it is not currently running, and the locate request does not complete until that server is started and ready to receive requests. As a result, the initial request on an indirect proxy may incur additional overhead as all of this activity occurs.

Error Recovery

If an error such as a connection failure occurs while a client is using an indirect proxy, the Ice run time clears the endpoints it has cached for that proxy and reissues a request to the locator. This request may result in a different set of endpoints; the actual behavior is determined by the locator implementation. If one of the new endpoints allows the Ice run time to successfully establish a connection, the application continues without interruption. Otherwise, the application receives an exception that indicates the cause of the failure.

Replication

An indirect proxy may substitute a replica group identifier (see page 15) in place of the object adapter identifier. In fact, the Ice run time does not distinguish between these two cases and considers a replica group identifier as equivalent to an object adapter identifier for the purposes of resolving the proxy. The location service implementation must be able to distinguish between replica groups and object adapters using only this identifier.

Connections and Requests

When using replication, the objective of the Ice run time is to establish a connection. Replication is a more sophisticated means of selecting an endpoint for a

connection; it does not provide the ability to distribute requests made on a single proxy among the replicas. Once a connection is established, the client communicates only with the server at that endpoint, just as if replication was never involved. All requests made via the proxy that initiated the connection are sent to the same server until that connection is closed.

After the connection is closed, such as by active connection management (see Section 35.4), subsequent use of the proxy causes the Ice run time to establish a new connection. Whether that new connection uses a different endpoint than previous connections depends on a number of factors, but it is possible for the client to connect to a different server than for previous requests.

31.17.3 Configuring a Client

An Ice client application must supply a proxy for the locator object, which it can do in several ways:

- by explicitly configuring an indirect proxy using the `ice_locator` proxy method (see Section 31.10.1)
- by calling `setDefaultLocator` on a communicator, after which all proxies use the given locator by default
- by defining the `Ice.Default.Locator` configuration property, which causes all proxies to use the given locator by default

The Ice run time's efforts to resolve an indirect proxy can be traced by setting the following configuration properties:

```
Ice.Trace.Network=2
Ice.Trace.Protocol=1
Ice.Trace.Location=2
```

See Appendix C for more information on these properties.

31.17.4 Server Semantics

A location service must know the endpoints of any object adapter whose identifier can be used in an indirect proxy. For example, suppose a client uses the following proxy:

```
Object1@PublicAdapter
```

The Ice run time in the client sends the identifier `PublicAdapter` to the locator, as described in Section 31.17.2, and expects to receive the associated

endpoints. The only way the location service can know these endpoints is if it is given them. When you consider that an object adapter's endpoints may not specify fixed ports, and therefore the endpoint addresses may change each time the object adapter is activated, it is clear that the best source of endpoint information is the object adapter itself. As a result, an object adapter that is properly configured (see Section 31.17.5) contacts the locator during activation to supply its identifier and current endpoints. More specifically, the object adapter registers itself with an object implementing the `Ice::LocatorRegistry` interface, whose proxy the object adapter obtains from the locator.

Registration Requirements

A location service may require that all object adapters be pre-registered via some implementation-specific mechanism. (IceGrid behaves this way by default.) This implies that activation can fail if the object adapter supplies an identifier that is unknown to the location service. In such a situation, the object adapter's `activate` operation raises `NotRegisteredException`.

In a similar manner, an object adapter that participates in a replica group (see page 15) includes the group's identifier in the locator request that is sent during activation. If the location service requires replica group members to be configured in advance, `activate` raises `NotRegisteredException` if the object adapter's identifier is not one of the group's registered participants (see Section 37.8.2).

31.17.5 Configuring a Server

An object adapter must be able to obtain a locator proxy in order to register itself with a location service. Each object adapter can be configured with its own locator proxy by defining its `Locator` property, as shown in the example below for the object adapter named `SampleAdapter`:

```
SampleAdapter.Locator=IceGrid/Locator:tcp -h locatorhost -p 10000
```

Alternatively, a server may call `setLocator` on the object adapter prior to activation. If the object adapter is not explicitly configured with a locator proxy, it uses the default locator as provided by its communicator (see Section 31.17.3).

Two other configuration properties influence an object adapter's interactions with a location service during activation:

- `AdapterId`

Configuring a non-empty identifier for the `AdapterId` property causes the object adapter to register itself with the location service. A locator proxy must also be configured.

- `ReplicaGroupId`

Configuring a non-empty identifier for the `ReplicaGroupId` property indicates that the object adapter is a member of a replica group (see page 15). For this property to have an effect, `AdapterId` must also be configured with a non-empty value.

We can use these properties as shown below:

```
SampleAdapter.AdapterId=SampleAdapterId
SampleAdapter.ReplicaGroupId=SampleGroupId
SampleAdapter.Locator=IceGrid/Locator:tcp -h locatorhost -p 10000
```

Refer to Section 31.17.4 for information on the pre-registration requirements a location service may enforce.

31.17.6 Process Registration

An activation service, such as an IceGrid node (see Chapter 37), needs a reliable way to gracefully deactivate a server. One approach is to use a platform-specific mechanism, such as POSIX signals. This works well on POSIX platforms when the server is prepared to intercept signals and react appropriately (see Section 30.11). On Windows platforms, it works less reliably for C++ servers, and not at all for Java servers. For these reasons, the Ice run time provides an alternative that is both portable and reliable.

Ice::Process

The Slice interface `Ice::Process` allows an activation service to request a graceful shutdown of the server:

```
module Ice {
interface Process {
    ["ami"] idempotent void shutdown();
    void writeMessage(string message, int fd);
};
};
```

When `shutdown` is invoked, the object implementing this interface is expected to initiate the termination of its server process. The activation service may expect the

server to terminate within a certain period of time, after which it may terminate the server abruptly.

Configuration Requirements

For an activation service to use the `Ice::Process` interface to shut down a server, it must have a proxy to an object implemented in that server.

The simplest and most-common way for a server to register an `Ice::Process` proxy is to set the object adapter property `RegisterProcess` to a non-zero value. For example, an object adapter named `ShutdownAdapter` is configured as shown below:

```
ShutdownAdapter.RegisterProcess=1
```

This setting causes a newly-activated object adapter to create a servant implementing the `Ice::Process` interface, add that servant to the active servant map using a UUID for the identity, and invoke an operation on the location service to register the proxy. A server should configure at most one of its object adapters with this property.

The object adapter also requires a value for the `Ice.ServerId` property, which allows the activation service to uniquely identify the server:

```
Ice.ServerId=SampleServerId  
ShutdownAdapter.RegisterProcess=1
```

Security Considerations

The `Ice::Process` servant responds to the shutdown request by invoking `shutdown` on the communicator. This presents a potential security hole: if a hostile client obtained the proxy, it could make a denial-of-service attack by shutting down the server. It is therefore important that careful consideration be given to the server's endpoints in order to minimize the risk of an attack. Specifically, an object adapter can be configured with secure endpoints, or a separate object adapter can be dedicated to the `Ice::Process` servant and configured with an endpoint that is accessible only to the activation service. Since the activation service is normally running on the same host as the server, a reasonably secure choice for an endpoint would select the localhost interface (`-h 127.0.0.1`) so that only a process on the same host could use it.

31.18 The Ice::Logger Interface

Depending on the setting of various properties (see Chapter 30), the Ice run time produces trace, warning, or error messages. These messages are written via the Ice::Logger interface:

```
module Ice {
    local interface Logger {
        void print(string message);
        void trace(string category, string message);
        void warning(string message);
        void error(string message);
    };
};
```

A default logger is instantiated when you create a communicator. The default logger logs to the standard error output. The trace operation accepts a category parameter in addition to the error message; this allows you to separate trace output from different subsystems by sending the output through a filter.

You can obtain the logger that is attached to a communicator:

```
module Ice {
    local interface Communicator {
        Logger getLogger();
    };
};
```

To install a logger other than the default one, you can pass it in an `InitializationData` parameter to `initialize` (see Section 31.3) when you create a communicator.

Changing the `Logger` object that is attached to a communicator allows you to integrate Ice messages into your own message handling system. For example, for a complex application, you might have an already existing logging framework. To integrate Ice messages into that framework, you can create your own `Logger` implementation that logs messages to the existing framework.

When you destroy a communicator, its logger is *not* destroyed. This means that you can safely use a logger even beyond the lifetime of its communicator.

For convenience, Ice provides two platform-specific logger implementations: one that logs its messages to the Unix `syslog` facility, and another that uses the Windows event log. You can activate the `syslog` implementation by setting the `Ice.UseSyslog` property, and the Windows event log implementation by setting the `Ice.UseEventLog` property. Both implementations use the value of

the `Ice.ProgramName` property to identify the application to the log subsystem.

The `syslog` logger implementation is available in C++, Java, and C#, whereas the Windows event log implementation is only available in C++. See Section 8.3.2 for additional information on using these logger implementations in C++.

31.19 The `Ice::Stats` Interface

The Ice run time reports bytes sent and received over the wire on every operation invocation via the `Ice::Stats` interface:

```
module Ice {
    local interface Stats {
        void bytesSent(string protocol, int num);
        void bytesReceived(string protocol, int num);
    };

    local interface Communicator {
        Stats getStats();
        // ...
    };
};
```

The Ice run time calls `bytesReceived` as it reads from the network and `bytesSent` as it writes to the network. A very simple implementation of the `Stats` interface could look like the following:

```
class MyStats : public virtual Ice::Stats {
public:
    virtual void bytesSent(const string& prot, Ice::Int num)
    {
        cerr << prot << ": sent " << num << "bytes" << endl;
    }

    virtual void bytesReceived(const string& prot, Ice::Int)
    {
        cerr << prot << ": received " << num << "bytes" << endl;
    }
};
```

To register your implementation, you must pass it in an `InitializationData` parameter when you call `initialize` to create the communicator (see Section 31.3):

```
Ice::InitializationData id;
id.stats = new MyStats;
Ice::CommunicatorPtr ic = Ice::initialize(id);
```

You can install a `Stats` object on either the client or the server side (or both). Here is some example output produced by installing a `MyStats` object in a simple server:

```
tcp: received 14 bytes
tcp: received 32 bytes
tcp: sent 26 bytes
tcp: received 14 bytes
tcp: received 33 bytes
tcp: sent 25 bytes
...
```

In practice, your `Stats` implementation will probably be a bit more sophisticated: for example, the object can accumulate statistics in member variables and make the accumulated statistics available via member functions, instead of simply printing everything to the standard error output.

31.20 Location Transparency

One of the useful features of the Ice run time is that it is *location transparent*: the client does not need to know where the implementation of an Ice object resides; an invocation on an object automatically is directed to the correct target, whether the object is implemented in the local address space, in another address space on the same machine, or in another address space on a remote machine. Location transparency is important because it allows us to change the location of an object implementation without breaking client programs and, by using `IceGrid` (see Chapter 37), addressing information such as domain names and port numbers can be externalized so they do not appear in stringified proxies.

For invocations that cross address space boundaries (or more accurately, cross communicator boundaries), the Ice run time dispatches requests via the appropriate transport. However, for invocations that are via proxies for which the proxies and the servants that process the invocation share the same communicator (so-called *collocated* invocations), the Ice run, by default, does not send the invo-

cation via the transport specified in the proxy. Instead, collocated invocations are short-cut inside the Ice run time and dispatched directly.¹¹ (This is the default behavior. You can disable the collocation optimization by creating a proxy that disables the collocation optimization—see page 864.)

The reason for this is efficiency: if collocated invocations were sent via TCP/IP, for example, invocations would still be sent via the operating system kernel (using the back plane instead of a network) and would incur the full cost of creating TCP/IP connections, marshaling requests into packets, trapping in and out of the kernel, and so on. By optimizing collocated requests, much of this overhead can be avoided, so collocated invocations are almost as fast as a local function call.

For efficiency reasons, collocated invocations are not completely location transparent, that is, a collocated call has semantics that differ in some ways from calls that cross address-space boundaries. Specifically, collocated invocations differ from ordinary invocations in the following respects:

- Collocated invocations are dispatched in the calling thread instead of being dispatched using the server's concurrency model.
- The object adapter holding state is ignored: collocated invocations proceed normally even if the target object's adapter is in the holding state.
- For collocated invocations, classes and exceptions are never sliced. Instead, the receiver always receives a class or exception as the derived type that was sent by the sender.
- If a collocated invocation throws an exception that is not in an operation's exception specification, the original exception is raised in the client instead of `UnknownUserException`. (This applies to the C++ mapping only.)
- Class factories are ignored for collocated invocations.
- Timeouts on invocations are ignored.

In practice, these differences rarely matter. The most likely cause of surprises with collocated invocations is dispatch in the calling thread, that is, a collocated invocation behaves like a local, synchronous procedure call. This can cause problems if, for example, the calling thread acquires a lock that an operation implementation tries to acquire as well: unless you use recursive mutexes (see Chapter 30), this will cause deadlock.

11. Note that if the proxy and the servant do not use the same communicator, the invocation is *not* collocated, even though caller and callee are in the same address space.

You can create a proxy that disables the collocation optimization by calling `ice_collocationOptimized(false)`.

31.21 C++ String Conversion

For languages other than C++, Ice encodes strings in their native Unicode representation, so applications can transparently use characters from non-English alphabets. However, for C++, the string encoding depends on which mapping is chosen for a particular string, the default mapping to `std::string`, or the alternative mapping to `std::wstring` (see Section 6.6.1).¹² This section explains how strings are encoded by the Ice run time, and how you can achieve automatic conversion of strings into a particular encoding.¹³

On the wire, Ice transmits all strings as Unicode strings in UTF-8 encoding (see Chapter 34). However, the native C++ representation for strings that contain non-English characters depends on the platform, as well as on locale settings and whether you use the narrow or wide mapping for Slice strings. By default, the Ice run time encodes strings as follows:

- Narrow strings (that is, strings mapped to `std::string`) are presented to the application in UTF-8 encoding and, similarly, the application is expected to provide narrow strings in UTF-8 encoding to the Ice run time for transmission.

With this default behavior, the application code is responsible for converting between the native codeset for 8-bit characters and UTF-8. For example, if the native codeset is ISO Latin-1, the application is responsible for converting between UTF-8 and narrow (8-bit) characters in ISO Latin-1 encoding.

Also note that the default behavior does not require the application to do anything if it only uses characters in the ASCII range. (This is because a string containing only characters in the ASCII range is also a valid UTF-8 string.)

- Wide strings (that is, strings mapped to `std::wstring`) are automatically encoded as Unicode by the Ice run time as appropriate for the platform. For example, for AIX in 32-bit mode, the Ice run time converts between UTF-8 and UTF-16 in big-endian representation whereas, for AIX in 64-bit mode, the

12.The remainder of this section is not relevant to languages other than C++.

13.See the `demo` directory in the Ice for C++ distribution for an example of using string converters.

Ice run time converts between UTF-8 and UTF-32 in big-endian representation.

With this default behavior, wide strings are transparently converted between their one-the-wire representation and their native C++ representation as appropriate, so application code need not do anything special. (The exception is if an application uses a non-Unicode encoding, such as Shift-JIS, as its native codeset.)

The default behavior of the run time can be changed by providing application-specific string converters. If you install such converters, all Slice strings will be passed to the appropriate converter when they are marshaled and unmarshaled. Therefore, the string converters allow you to convert all strings transparently into their native representation without having to insert explicit conversion calls whenever a string crosses a Slice interface boundary.

You can install string converters on a per-communicator basis when you create a communicator by setting the `stringConverter` and `wstringConverter` members of the `InitializationData` structure (see Section 31.3). Any strings that use the default (`std::string`) mapping are passed through the specified `stringConverter`, and any strings that use the wide (`std::wstring`) mapping are passed through the specified `wstringConverter`.

The string converters are defined as follows:

```
namespace Ice {

class ICE_API UTF8Buffer {
public:
    virtual Byte* getMoreBytes(size_t howMany,
                               Byte* firstUnused) = 0;

    virtual ~UTF8Buffer() {}
};

template<typename charT>
class BasicStringConverter : public IceUtil::Shared {
public:
    virtual Byte*
        toUTF8(const charT* sourceStart, const charT* sourceEnd,
               UTF8Buffer&) const = 0;

    virtual void fromUTF8(const Byte* sourceStart,
                          const Byte* sourceEnd,
                          std::basic_string<charT>& target) const;
};
```



```
typedef BasicStringConverter<char> StringConverter;  
typedef IceUtil::Handle<StringConverter> StringConverterPtr;  
  
typedef BasicStringConverter<wchar_t> WstringConverter;  
typedef IceUtil::Handle<WstringConverter> WstringConverterPtr;  
  
}
```

As you can see, both narrow and wide string converters are simply templates with either a narrow or a wide character (`char` or `wchar_t`) as the template parameter.

31.21.1 Converting to UTF-8

If you have a string converter installed, the Ice run time calls the `toUTF` method whenever it needs to convert a native string into UTF-8 representation for transmission. The `sourceStart` and `sourceEnd` pointers point at the first byte and one-beyond-the-last byte of the source string, respectively. The implementation of `toUTF8` must return a pointer to the first unused byte following the converted string.

Your implementation of `toUTF8` must allocate the returned string by calling the `getMoreBytes` member function of the `UTF8Buffer` class that is passed as the third argument. (`getMoreBytes` throws a `MemoryLimitException` if it cannot allocate enough memory). The `firstUnused` parameter must point at the first unused byte of the allocated memory region. You can make several calls to `getMoreBytes` to incrementally allocate memory for the converted string. If you do, `getMoreBytes` may relocate the buffer in memory. (If it does, it copies the part of the string that was converted so far into the new memory region.) The function returns a pointer to the first unused byte of the (possibly relocated) memory.

Conversion with `toUTF8` can fail because no more memory is available, in which case you should throw a `MemoryLimitException`. Conversion can also fail because the encoding of the source string is internally incorrect. In that case, you should throw a `StringConversionFailed` exception from `toUTF8`.

The Ice run time deallocates the returned string once it has marshaled it.

31.21.2 Converting from UTF-8

During unmarshaling, the Ice run time calls the `fromUTF8` member function on the corresponding string converter. The function converts a UTF-8 string into its native form as a `std::string`. (The string into which the function must place the converted characters is passed to `fromUTF8` as the `target` parameter.)

31.22 A Comparison of the Ice and CORBA Run Time

The CORBA equivalent of the server-side functionality of Ice is the Portable Object Adapter (POA). The most striking difference between Ice and the POA is the simplicity of the Ice APIs: Ice is just as fully featured as the POA but achieves this functionality with much simpler interfaces and far fewer operations. Here are a few of the more notable differences:

- Ice object adapters are not hierarchical, whereas POAs are arranged into a hierarchy. It is unclear why CORBA chose to put its adapters into a hierarchy. The hierarchy complicates the POA interfaces but the feature does not provide any apparent benefit: the inheritance of object adapters has no meaning. In particular, POA policies are *not* inherited from the parent adapter. POA hierarchies can be used to control the order of destruction of POAs. However, it is simpler and easier to explicitly destroy adapters in the correct order, as is done in Ice.
- The POA uses a complex policy mechanism to control the behavior of object adapters. The policies can be combined in numerous ways, despite the fact that most combinations do not make sense. This not only is a frequent source of programming errors, but also complicates the API with additional exception semantics for many of its operations.
- The CORBA run time does not provide access to the ORB object (the equivalent of the Ice communicator) during method dispatch. Yet, access to the ORB object is frequently necessary inside operation implementations. As a result, programmers are forced to keep the ORB object in global variable and, if multiple ORBs are used, there is no way to identify the correct ORB for a particular request. The Ice run time eliminates these problems by always providing access to the communicator via the adapter that is passed as part of the `Current` object.

- The POA attaches implementation techniques to object adapters. For example, an object adapter that uses a servant locator cannot also use an active servant map.

The POA also distinguishes between servant locators (which are similar to Ice servant locators) and servant activators (which work like the incrementally initializing servant locator in Section 31.8.1). Yet, there is no need to distinguish the two concepts: a servant activator is simply a special case of a servant locator that can be implemented trivially.

Similarly, default servants must be registered with a POA by making a special API call when, in fact, there is no need to cater for default servants as a separate concept. As shown in Section 31.8.2, with Ice, you can use a trivial servant locator to achieve the same effect.

- The POA uses separate POA manager objects to control adapter states. This not only complicates the APIs considerably, it also makes it possible to combine hierarchies of object adapters with groupings of POA managers in meaningless ways, leading to undefined behavior. Ice does not use separate objects to control adapter states and so eliminates the associated complexities without loss of functionality.
- The POA interfaces have the notion of a default Root POA that is used unless the programmer overrides it explicitly. This misfeature is a frequent source of errors, due to inappropriate policies that were chosen for the Root POA. (Users of CORBA will probably have been bitten by implicit activation of objects on the Root POA, instead of the intended POA.)
- The POA provides the concept of implicit activation as well as the notion of system-generated object identities as part of the object adapter policies. This design is a frequent source of programming errors because it leads to many implicit activities behind the scenes, some of them with surprising side effects. (It is sad to see that all this complexity was added to avoid a single line of code during object activation.) Ice does not provide a notion of implicit activation or implicit generation of object identities. Instead, servants are given an identity explicitly and are activated explicitly, which avoids the complexity and confusion.
- CORBA has no notion of datagrams, or of batched invocations, both of which can provide substantial performance gains.
- CORBA provides no standardized way to integrate ORB messages into existing logging frameworks and does not provide access to network statistics.

In summary, the Ice run time provides all the functionality of the POA (and more) with an API that is a fraction in size. By cleanly separating orthogonal concepts and by providing a minimal but sufficient API, Ice not only provides a simpler and easier-to use API, but also results in binaries that are smaller in size. This not only reduces the memory requirements of Ice binaries, but also contributes to better performance due to reduced working set size.

31.23 Summary

In this chapter, we explored the server-side run time in detail. Communicators are the main handle to the Ice run time. They provide access to a number of run time resources and allow you to control the life cycle of a server. Object adapters provide a mapping between abstract Ice objects and concrete servants. Various implementation techniques are at your disposal to control the trade-off between performance and scalability; in particular, servant locators are a central mechanism that permits you to choose an implementation technique that matches the requirements of your application.

Ice provides both oneway and datagram invocations. These provide performance gains in situations where an application needs to provide numerous stateless updates. Batching such invocations permits you to increase performance even further.

The Ice logging mechanism is user extensible, so you can integrate Ice message into arbitrary logging frameworks, and the `Ice::Stats` interface permits you to collect statistics for network bandwidth consumption.

Finally, even though Ice is location transparent, in the interest of efficiency, collocated invocations do not behave in all respects like remote invocations. You need to be aware of these differences, especially for applications that are sensitive to thread context.

Chapter 32

Asynchronous Programming

32.1 Chapter Overview

This chapter describes the asynchronous programming facilities in Ice. Section 32.2 gives a brief overview of the capabilities and demonstrates how to modify Slice definitions to enable asynchronous support in language mappings. The client-side facilities are presented in Section 32.3 and are followed by a discussion of the server-side facilities in Section 32.4.

32.2 Introduction

Modern middleware technologies attempt to ease the programmer's transition to distributed application development by making remote invocations as easy to use as traditional method calls: a method is invoked on an object and, when the method completes, the results are returned or an exception is raised. Of course, in a distributed system the object's implementation may reside on another host, and consequently there are some semantic differences that the programmer must be aware of, such as the overhead of remote invocations and the possibility of network-related errors. Despite those issues, the programmer's experience with object-oriented programming is still relevant, and this *synchronous* programming

model, in which the calling thread is blocked until the operation returns, is familiar and easily understood.

Ice is inherently an asynchronous middleware platform that simulates synchronous behavior for the benefit of applications (and their programmers). When an Ice application makes a synchronous twoway invocation on a proxy for a remote object, the operation's parameters are marshaled into a message that is written to a transport, and the calling thread is blocked in order to simulate a synchronous method call. Meanwhile, the Ice run-time operates in the background, processing messages until the desired reply is received and the calling thread can be unblocked to unmarshal the results.

There are many cases, however, in which the blocking nature of synchronous programming is too restrictive. For example, the application may have useful work it can do while it awaits the response to a remote invocation; using a synchronous invocation in this case forces the application to either postpone the work until the response is received, or perform this work in a separate thread. When neither of these alternatives are acceptable, the asynchronous facilities provided with Ice are an effective solution for improving performance and scalability, or simplifying complex application tasks.

32.2.1 Asynchronous Method Invocation

Asynchronous Method Invocation (AMI) is the term used to describe the client-side support for the asynchronous programming model. Using AMI, a remote invocation does not block the calling thread while the Ice run-time awaits the reply. Instead, the calling thread can continue its activities, and the application is notified by the Ice run-time when the reply eventually arrives. Notification occurs via a callback to an application-supplied programming-language object¹. AMI is described in detail in Section 32.3.

32.2.2 Asynchronous Method Dispatch

The number of simultaneous synchronous requests a server is capable of supporting is determined by the server's concurrency model (see Section 31.9). If all of the threads are busy dispatching long-running operations, then no threads

1. Polling for a response is not supported by the Ice run-time, but it can be implemented easily by the application if desired.

are available to process new requests and therefore clients may experience an unacceptable lack of responsiveness.

Asynchronous Method Dispatch (AMD), the server-side equivalent of AMI, addresses this scalability issue. Using AMD, a server can receive a request but then suspend its processing in order to release the dispatch thread as soon as possible. When processing resumes and the results are available, the server sends a response explicitly using a callback object provided by the Ice run-time.

In practical terms, an AMD operation typically queues the request data (i.e., the callback object and operation arguments) for later processing by an application thread (or thread pool). In this way, the server minimizes the use of dispatch threads and becomes capable of efficiently supporting thousands of simultaneous clients.

An alternate use case for AMD is an operation that requires further processing after completing the client's request. In order to minimize the client's delay, the operation returns the results while still in the dispatch thread, and then continues using the dispatch thread for additional work.

See Section 32.4 for more information on AMD.

32.2.3 Controlling Code Generation using Metadata

A programmer indicates a desire to use an asynchronous model (AMI, AMD, or both) by annotating Slice definitions with metadata (Section 4.17). The programmer can specify this metadata at two levels: for an interface or class, or for an individual operation. If specified for an interface or class, then asynchronous support is generated for all of its operations. Alternatively, if asynchronous support is needed only for certain operations, then the generated code can be minimized by specifying the metadata only for those operations that require it.

Synchronous invocation methods are always generated in a proxy; specifying AMI metadata merely adds asynchronous invocation methods. In contrast, specifying AMD metadata causes the synchronous dispatch methods to be *replaced* with their asynchronous counterparts. This semantic difference between AMI and AMD is ultimately practical: it is beneficial to provide a client with synchronous and asynchronous versions of an invocation method, but doing the equivalent in a server would require the programmer to implement both versions of the dispatch method, which has no tangible benefits and several potential pitfalls.

Consider the following Slice definitions:

```
["ami"] interface I {
    bool isValid();
    float computeRate();
};

interface J {
    ["amd"] void startProcess();
    ["ami", "amd"] int endProcess();
};
```

In this example, all proxy methods of interface I are generated with support for synchronous and asynchronous invocations. In interface J, the `startProcess` operation uses asynchronous dispatch, and the `endProcess` operation supports asynchronous invocation and dispatch.

Specifying metadata at the operation level, rather than at the interface or class level, not only minimizes the amount of generated code, but more importantly, it minimizes complexity. Although the asynchronous model is more flexible, it is also more complicated to use. It is therefore in your best interest to limit the use of the asynchronous model to those operations for which it provides a particular advantage, while using the simpler synchronous model for the rest.

32.2.4 Transparency

The use of an asynchronous model does not affect what is sent “on the wire.” Specifically, the invocation model used by a client is transparent to the server, and the dispatch model used by a server is transparent to the client. Therefore, a server has no way to distinguish a client’s synchronous invocation from an asynchronous invocation, and a client has no way to distinguish a server’s synchronous reply from an asynchronous reply.

32.3 Using AMI

In this section, we describe the Ice implementation of AMI and how to use it. We begin by discussing a way to (partially) simulate AMI using oneway invocations. This is not a technique that we recommend, but it is an informative exercise that highlights the benefits of AMI and illustrates how it works. Next, we explain the AMI mapping and illustrate its use with examples.

32.3.1 Simulating AMI using Oneways

As we discussed at the beginning of the chapter, synchronous invocations are not appropriate for certain types of applications. For example, an application with a graphical user interface typically must avoid blocking the window system's event dispatch thread because blocking makes the application unresponsive to user commands. In this situation, making a synchronous remote invocation is asking for trouble.

The application could avoid this situation using oneway invocations (see Section 31.13), which by definition cannot return a value or have any out parameters. Since the Ice run-time does not expect a reply, the invocation blocks only as long as it takes to marshal and copy the message into the local transport buffer. However, the use of oneway invocations may require unacceptable changes to the interface definitions. For example, a twoway invocation that returns results or raises user exceptions must be converted into at least two operations: one for the client to invoke with oneway semantics that contains only in parameters, and one (or more) for the server to invoke to notify the client of the results.

To illustrate these changes, suppose that we have the following Slice definition:

```
interface I {
    int op(string s, out long l);
};
```

In its current form, the operation `op` is not suitable for a oneway invocation because it has an out parameter and a non-void return type. In order to accommodate a oneway invocation of `op`, we can change the Slice definitions as shown below:

```
interface ICallback {
    void opResults(int result, long l);
};

interface I {
    void op(ICallback* cb, string s);
};
```

We made several modifications to the original definition:

- We added interface `ICallback`, containing an operation `opResults` whose arguments represent the results of the original twoway operation. The server invokes this operation to notify the client of the completion of the operation.

- We modified `I : : op` to be compliant with oneway semantics: it now has a `void` return type, and takes only in parameters.
- We added a parameter to `I : : op` that allows the client to supply a proxy for its callback object.

As you can see, we have made significant changes to our interface definitions to accommodate the implementation requirements of the client. One ramification of these changes is that the client must now also be a server, because it must create an instance of `ICallback` and register it with an object adapter in order to receive notifications of completed operations.

A more severe ramification, however, is the impact these changes have on the type system, and therefore on the server. Whether a client invokes an operation synchronously or asynchronously should be irrelevant to the server; this is an artifact of behavior that should have no impact on the type system. By changing the type system as shown above, we have tightly coupled the server to the client, and eliminated the ability for `op` to be invoked synchronously.

To make matters even worse, consider what would happen if `op` could raise user exceptions. In this case, `ICallback` would have to be expanded with additional operations that allow the server to notify the client of the occurrence of each exception. Since exceptions cannot be used as parameter or member types in `Slice`, this quickly becomes a difficult endeavor, and the results are likely to be equally difficult to use.

At this point, you will hopefully agree that this technique is flawed in many ways, so why do we bother describing it in such detail? The reason is that the Ice implementation of AMI uses a strategy similar to the one described above, with several important differences:

1. No changes to the type system are required in order to use AMI. The on-the-wire representation of the data is identical, therefore synchronous and asynchronous clients and servers can coexist in the same system, using the same operations.
2. The AMI solution accommodates exceptions in a reasonable way.
3. Using AMI does not require the client to also be a server.

32.3.2 Language Mappings

An operation for which the AMI metadata has been specified supports both synchronous and asynchronous invocation models. In addition to the proxy method for synchronous invocation, the code generator creates a proxy method for

asynchronous invocation, plus a supporting callback class. The generated code uses a pattern similar to the Slice modifications we made to the example in Section 32.3.1: the out parameters and return value are removed, leaving only in parameters for the invocation; the application supplies a callback object that is invoked with the results of the operation. In this case, however, the callback object is a purely local entity that is invoked by the Ice run-time in the client. The name of the callback class is constructed so that it cannot conflict with a user-defined Slice identifier.

C++ Mapping

The C++ mapping emits the following code for each AMI operation:

1. An abstract callback class used by the Ice run-time to notify the application about the completion of an operation. The name of the class is formed using the pattern `AMI_class_op`. For example, an operation named `foo` defined in interface `I` results in a class named `AMI_I_foo`. The class is generated in the same scope as the interface or class containing the operation. Two methods are provided:

```
void ice_response(<params>);
```

Indicates that the operation completed successfully. The parameters represent the return value and out parameters of the operation. If the operation has a non-void return type, then the first parameter of the `ice_response` method supplies the return value of the operation. Any out parameters present in the operation follow the return value, in the order of declaration.

```
void ice_exception(const Ice::Exception &);
```

Indicates that a local or user exception was raised.

2. An additional proxy method, having the mapped name of the operation with the suffix `_async`. This method has a `void` return type. The first parameter is a smart pointer to an instance of the callback class described above. The remaining parameters comprise the in parameters of the operation, in the order of declaration.

For example, suppose we have defined the following operation:

```
interface I {
    ["ami"] int foo(short s, out long l);
};
```

The callback class generated for operation `foo` is shown below:

```

namespace Demo {
    class AMI_I_foo : public ... {
    public:
        virtual void ice_response(Ice::Int, Ice::Long) = 0;
        virtual void ice_exception(const Ice::Exception&) = 0;
    };

    typedef IceUtil::Handle<AMI_I_foo> AMI_I_fooPtr;
}

```

The proxy method for asynchronous invocation of operation `foo` is generated as follows:

```
void foo_async(const AMI_I_fooPtr&, Ice::Short);
```

Java Mapping

The Java mapping emits the following code for each AMI operation:

1. An abstract callback class used by the Ice run-time to notify the application about the completion of an operation. The name of the class is formed using the pattern `AMI_class_op`. For example, an operation named `foo` defined in interface `I` results in a class named `AMI_I_foo`. The class is generated in the same scope as the interface or class containing the operation. Three methods are provided:

```
public void ice_response(<params>);
```

Indicates that the operation completed successfully. The parameters represent the return value and out parameters of the operation. If the operation has a non-void return type, then the first parameter of the `ice_response` method supplies the return value of the operation. Any out parameters present in the operation follow the return value, in the order of declaration.

```
public void ice_exception(Ice.LocalException ex);
```

Indicates that a local exception was raised.

```
public void ice_exception(Ice.UserException ex);
```

Indicates that a user exception was raised.

2. An additional proxy method, having the mapped name of the operation with the suffix `_async`. This method has a `void` return type. The first parameter is a reference to an instance of the callback class described above. The remaining parameters comprise the `in` parameters of the operation, in the order of declaration.

For example, suppose we have defined the following operation:

```
interface I {
    ["ami"] int foo(short s, out long l);
};
```

The callback class generated for operation `foo` is shown below:

```
public abstract class AMI_I_foo extends ... {
    public abstract void ice_response(int __ret, long l);
    public abstract void ice_exception(Ice.LocalException ex);
    public abstract void ice_exception(Ice.UserException ex);
}
```

The proxy method for asynchronous invocation of operation `foo` is generated as follows:

```
public void foo_async(AMI_I_foo __cb, short s);
```

C# Mapping

The C# mapping emits the following code for each AMI operation:

1. An abstract callback class used by the Ice run-time to notify the application about the completion of an operation. The name of the class is formed using the pattern `AMI_<class_op>`. For example, an operation named `foo` defined in interface `I` results in a class named `AMI_I_foo`. The class is generated in the same scope as the interface or class containing the operation. Two methods are provided:

```
public abstract void ice_response(<params>);
```

Indicates that the operation completed successfully. The parameters represent the return value and out parameters of the operation. If the operation has a non-void return type, then the first parameter of the `ice_response` method supplies the return value of the operation. Any out parameters present in the operation follow the return value, in the order of declaration.

```
public abstract void ice_exception(Ice.Exception ex);
```

Indicates that an exception was raised.

2. An additional proxy method, having the mapped name of the operation with the suffix `_async`. This method has a `void` return type. The first parameter is a reference to an instance of the callback class described above. The remaining parameters comprise the in parameters of the operation, in the order of declaration.

For example, suppose we have defined the following operation:

```
interface I {
    ["ami"] int foo(short s, out long l);
};
```

The callback class generated for operation foo is shown below:

```
namespace IceInternal
{
    public abstract class OutgoingAsync
    {
        public abstract void ice_exception(Ice.Exception ex);

        // ...
    }
}

namespace Demo
{
    public abstract class AMI_I_foo : IceInternal.OutgoingAsync
    {
        public abstract void ice_response(int __ret, long l);

        // Mapping-internal code here...
    }
}
```

A concrete implementation of the `AMI_I_foo` class must provide implementations for both the generated `ice_response` and the inherited `ice_exception` abstract methods.

The proxy method for asynchronous invocation of operation foo is generated as follows:

```
void foo_async(AMI_I_foo __cb, short s);
void foo_async(AMI_I_foo __cb, short s, Ice.Context __ctx);
```

As usual, the version of the operation without a context parameter forwards an empty context to the version with a context parameter.

Visual Basic Mapping

The Visual Basic mapping emits the following code for each AMI operation:

1. An abstract callback class used by the Ice run-time to notify the application about the completion of an operation. The name of the class is formed using the pattern `AMI_class_op`. For example, an operation named `foo` defined

in interface `I` results in a class named `AMI_I_foo`. The class is generated in the same scope as the interface or class containing the operation. Two methods are provided:

```
Public MustOverride Sub ice_response(<params>)
```

Indicates that the operation completed successfully. The parameters represent the return value and out parameters of the operation. If the operation has a non-void return type, then the first parameter of the `ice_response` method supplies the return value of the operation. Any out parameters present in the operation follow the return value, in the order of declaration.

```
Public MustOverride Sub ice_exception(ByVal ex As Ice.Exception)
```

Indicates that an exception was raised.

2. An additional proxy method, having the mapped name of the operation with the suffix `_async`. This method has a `void` return type. The first parameter is a reference to an instance of the callback class described above. The remaining parameters comprise the in parameters of the operation, in the order of declaration.

For example, suppose we have defined the following operation:

```
interface I {
    ["ami"] int foo(short s, out long l);
};
```

The callback class generated for operation `foo` is shown below:

```
Namespace IceInternal

    Public MustInherit Class OutgoingAsync

        Public MustOverride Sub ice_exception( _
            ByVal ex As Ice.Exception)
            ' ...

    End Class

End Namespace

namespace Demo

    Public MustInherit Class AMI_I_foo
        Inherits IceInternal.OutgoingAsync
```

```

        Public MustOverride Sub ice_response( _
                                           ByVal __ret As Integer, _
                                           ByVal l As Long)
        ' Mapping-internal code here...
    End Class

```

```
End Namespace
```

A concrete implementation of the `AMI_I_foo` class must provide implementations for both the generated `ice_response` and the inherited `ice_exception` abstract methods.

The proxy method for asynchronous invocation of operation `foo` is generated as follows:

```

Sub foo_async(ByVal __cb As AMI_I_foo, ByVal s As Short)

Sub foo_async(ByVal __cb As AMI_I_foo, ByVal s As Short, _
              ByVal __ctx As Ice.Context)

```

As usual, the version of the operation without a context parameter forwards an empty context to the version with a context parameter.

Python Mapping

For each AMI operation, the Python mapping emits an additional proxy method having the mapped name of the operation with the suffix `_async`. This method has a `void` return type. The first parameter is a reference to a callback object, as described below. The remaining parameters comprise the `in` parameters of the operation, in the order of declaration.

The asynchronous proxy method requires its callback object to define two methods:

```
def ice_response(self, <params>)
```

Indicates that the operation completed successfully. The parameters represent the return value and out parameters of the operation. If the operation has a non-void return type, then the first parameter of the `ice_response` method supplies the return value of the operation. Any out parameters present in the operation follow the return value, in the order of declaration.

```
def ice_exception(self, ex)
```

Indicates that a local or user exception was raised.

For example, suppose we have defined the following operation:

```
interface I {
    ["ami"] int foo(short s, out long l);
};
```

The method signatures required for the callback object of operation `foo` are shown below:

```
class ...
    #
    # Operation signatures:
    #
    # def ice_response(self, _result, l)
    # def ice_exception(self, ex)
```

The proxy method for asynchronous invocation of operation `foo` is generated as follows:

```
def foo_async(self, __cb, s)
```

32.3.3 Example

To demonstrate the use of AMI in Ice, let us define the `Slice` interface for a simple computational engine:

```
module Demo {
    sequence<float> Row;
    sequence<Row> Grid;

    exception RangeError {};

    interface Model {
        ["ami"] Grid interpolate(Grid data, float factor)
            throws RangeError;
    };
};
```

Given a two-dimensional grid of floating point values and a factor, the `interpolate` operation returns a new grid of the same size with the values interpolated in some interesting (but unspecified) way. In the sections below, we present C++, Java, C#, Visual Basic, and Python clients that invoke `interpolate` using AMI.

C++ Client

We must first define our callback implementation class, which derives from the generated class `AMI_Model_interpolate`:

```

class AMI_Model_interpolateI : public Demo::AMI_Model_interpolate
{
public:
    virtual void ice_response(const Demo::Grid& result)
    {
        cout << "received the grid" << endl;
        // ... postprocessing ...
    }

    virtual void ice_exception(const Ice::Exception& ex)
    {
        try {
            ex.ice_throw();
        } catch (const Demo::RangeError& e) {
            cerr << "interpolate failed: range error" << endl;
        } catch (const Ice::LocalException& e) {
            cerr << "interpolate failed: " << e << endl;
        }
    }
};

```

The implementation of `ice_response` reports a successful result, and `ice_exception` displays a diagnostic if an exception occurs.

The code to invoke `interpolate` is equally straightforward:

```

Demo::ModelPrx model = ...;
AMI_Model_interpolatePtr cb = new AMI_Model_interpolateI;
Demo::Grid grid;
initializeGrid(grid);
model->interpolate_async(cb, grid, 0.5);

```

After obtaining a proxy for a `Model` object, the client instantiates a callback object, initializes a grid and invokes the asynchronous version of `interpolate`. When the Ice run-time receives the response to this request, it invokes the callback object supplied by the client.

Java Client

We must first define our callback implementation class, which derives from the generated class `AMI_Model_interpolate`:

```

class AMI_Model_interpolateI extends Demo.AMI_Model_interpolate {
    public void ice_response(float[][] result)
    {
        System.out.println("received the grid");
        // ... postprocessing ...
    }
}

```

```

    }

    public void ice_exception(Ice.UserException ex)
    {
        assert(ex instanceof Demo.RangeError);
        System.err.println("interpolate failed: range error");
    }

    public void ice_exception(Ice.LocalException ex)
    {
        System.err.println("interpolate failed: " + ex);
    }
}

```

The implementation of `ice_response` reports a successful result, and the `ice_exception` methods display a diagnostic if an exception occurs.

The code to invoke `interpolate` is equally straightforward:

```

Demo.ModelPrx model = ...;
AMI_Model_interpolate cb = new AMI_Model_interpolateI();
float[][] grid = ...;
initializeGrid(grid);
model.interpolate_async(cb, grid, 0.5);

```

After obtaining a proxy for a `Model` object, the client instantiates a callback object, initializes a grid and invokes the asynchronous version of `interpolate`. When the Ice run-time receives the response to this request, it invokes the callback object supplied by the client.

C# Client

We must first define our callback implementation class, which derives from the generated class `AMI_Model_interpolate`:

```

using System;

class AMI_Model_interpolateI : Demo.AMI_Model_interpolate {
    public override void ice_response(float[][] result)
    {
        Console.WriteLine("received the grid");
        // ... postprocessing ...
    }

    public override void ice_exception(Ice.Exception ex)

```

```

    {
        Console.Error.WriteLine("interpolate failed: " + ex);
    }
}

```

The implementation of `ice_response` reports a successful result, and the `ice_exception` method displays a diagnostic if an exception occurs.

The code to invoke `interpolate` is equally straightforward:

```

Demo.ModelPrx model = ...;
AMI_Model_interpolate cb = new AMI_Model_interpolateI();
float[][] grid = ...;
initializeGrid(grid);
model.interpolate_async(cb, grid, 0.5);

```

Visual Basic Client

We must first define our callback implementation class, which derives from the generated class `AMI_Model_interpolate`:

```

imports System

Class AMI_Model_interpolateI
    Inherits Demo.AMI_Model_interpolate

    Public Overrides Sub ice_response(ByVal result As Single())
        Console.WriteLine("received the grid")
        ' ... postprocessing ...
    End Sub

    Public Overrides Sub ice_exception(ByVal ex As Ice.Exception)
        Console.Error.WriteLine("interpolate failed: " & ex)
    End Sub

End Class

```

The implementation of `ice_response` reports a successful result, and the `ice_exception` method displays a diagnostic if an exception occurs.

The code to invoke `interpolate` is equally straightforward:

```

Dim model As Demo.ModelPrx = ...
Dim cb As AMI_Model_interpolate = New AMI_Model_interpolateI
Dim grid As Single() = ...
initializeGrid(grid)
model.interpolate_async(cb, grid, 0.5)

```

Python Client

We must first define our callback implementation class:

```
class AMI_Model_interpolateI(object):
    def ice_response(self, result):
        print "received the grid"
        # ... postprocessing ...

    def ice_exception(self, ex):
        try:
            raise ex
        except Demo.RangeError, e:
            print "interpolate failed: range error"
        except Ice.LocalException, e:
            print "interpolate failed: " + str(e)
```

The implementation of `ice_response` reports a successful result, and the `ice_exception` method displays a diagnostic if an exception occurs.

The code to invoke `interpolate` is equally straightforward:

```
model = ...
cb = AMI_Model_interpolateI()
grid = ...
initializeGrid(grid)
model.interpolate_async(cb, grid, 0.5)
```

32.3.4 Concurrency Issues

Support for asynchronous invocations in Ice is enabled by the client thread pool (see Section 31.9), whose threads are primarily responsible for processing reply messages. It is important to understand the concurrency issues associated with asynchronous invocations:

- A callback object must not be used for multiple simultaneous invocations. An application that needs to aggregate information from multiple replies can create a separate object to which the callback objects delegate.
- Calls to the callback object are made by threads from the Ice run time's client thread pool, therefore synchronization may be necessary if the application might interact with the callback object at the same time as the reply arrives.
- The number of threads in the client thread pool determines the maximum number of simultaneous callbacks possible for asynchronous invocations. The default size of the client thread pool is one, meaning invocations on callback objects are serialized. If the size of the thread pool is increased, the application

may require synchronization, such as when multiple callback objects delegate to a single shared object.

- AMI invocations are always made without collocation optimization, regardless of the optimization setting of the proxy (see Section 31.20).

32.3.5 Timeouts

Supporting the use of timeouts for asynchronous invocations presents a special challenge for the Ice run time. Unlike synchronous invocations, for which the Ice run time simply blocks the calling thread for the specified timeout period, asynchronous invocations must return control to the calling thread as soon as possible.

Consequently, the Ice run time is forced to use another mechanism: a dedicated thread that, among other duties, periodically reviews pending asynchronous invocations. If an invocation has a timeout that has expired, the dedicated thread terminates the invocation by reporting `Ice::TimeoutException` to the `ice_exception` method of the invocation's callback object. For example, we can handle this exception in C++ as shown below:

```
class AMI_Model_interpolateI : public Demo::AMI_Model_interpolate
{
public:
    // ...

    virtual void ice_exception(const Ice::Exception& ex)
    {
        try {
            ex.ice_throw();
        } catch (const Demo::RangeError& e) {
            cerr << "interpolate failed: range error" << endl;
        } catch (const Ice::TimeoutException&) {
            cerr << "interpolate failed: timeout" << endl;
        } catch (const Ice::LocalException& e) {
            cerr << "interpolate failed: " << e << endl;
        }
    }
};
```

The configuration property `Ice.MonitorConnections`, whose value is specified in seconds, determines the frequency with which the dedicated thread performs these reviews. If the property is set to zero, the thread is disabled and AMI timeouts do not occur.

The use of a dedicated thread to monitor pending asynchronous invocations means the precision of invocation timeouts is dependent on the value of the `Ice.MonitorConnections` property. For example, if you make an asynchronous invocation using a proxy with a timeout of 5000ms and `Ice.MonitorConnections` is set to 30, it can take up to thirty seconds for the timeout to be reported to the callback object. You can improve the accuracy of AMI timeouts by setting `Ice.MonitorConnections` to a value that is closer to your timeout, just be careful that you do not cause the dedicated thread to consume too much processing time.

32.3.6 Error Handling

It is important to remember that *all* errors encountered by an AMI invocation are reported back via the `ice_exception` callback, even if the error condition is encountered “on the way out”, when the operation is invoked. The reason for this is consistency: if an invocation, such as `foo_async` could throw exceptions, you would have to handle exceptions in two places in your code: at the point of call for exception that are encountered “on the way out”, and in `ice_exception` for error conditions that are detected after the call is initiated.

Where this matters is if you want to send off a number of AMI calls, each of which depends on the preceding call to have succeeded. For example:

```
p1->foo_async(cb1);  
p2->bar_async(cb2);
```

If `bar` depends for its correct working on the successful completion of `foo`, this code will not work because the `bar` invocation will be sent regardless of whether `foo` failed or not.

In such cases, where you need to be sure that one call is dispatched only if a preceding call succeeds, you must instead invoke `bar` from within `foo`'s `ice_response` implementation, instead of from the main-line code.

32.4 Using AMD

This section describes the language mappings for AMD and continues the example introduced in Section 32.3.

32.4.1 Language Mappings

As we discussed in Section 32.3.2, the language mappings for AMI continue to allow applications to use the synchronous invocation model if desired: specifying the AMI metadata for an operation leaves the proxy method for synchronous invocation intact, and causes an additional proxy method to be generated in support of asynchronous invocation.

The language mappings for an AMD operation, however, do not allow the implementation to use both dispatch models. Specifying the AMD metadata causes the method for synchronous dispatch to be replaced with a method for asynchronous dispatch.

The asynchronous dispatch method has a signature similar to that of AMI: the return type is `void`, and the arguments consist of a callback object and the operation's in parameters. In AMI the callback object is supplied by the application, but in AMD the callback object is supplied by the Ice run-time and provides methods for returning the operation's results or reporting an exception. The implementation is not required to invoke the callback object before the dispatch method returns; the callback object can be invoked at any time by any thread, but may only be invoked once. The name of the callback class is constructed so that it cannot conflict with a user-defined Slice identifier.

The details for each language mapping are provided below.

C++ Mapping

The C++ mapping emits the following code for each AMD operation:

1. A callback class used by the implementation to notify the Ice run-time about the completion of an operation. The name of this class is formed using the pattern `AMD_class_op`. For example, an operation named `foo` defined in interface `I` results in a class named `AMD_I_foo`. The class is generated in the same scope as the interface or class containing the operation. Several methods are provided:

```
void ice_response(<params>);
```

The `ice_response` method allows the server to report the successful completion of the operation. If the operation has a non-void return type, the first parameter to `ice_response` is the return value. Parameters corresponding to the operation's out parameters follow the return value, in the order of declaration.

```
void ice_exception(const Ice::Exception &);
```

This version of `ice_exception` allows the server to report a user or local exception.

```
void ice_exception(const std::exception &);
```

This version of `ice_exception` allows the server to report a standard exception.

```
void ice_exception();
```

This version of `ice_exception` allows the server to report an unknown exception.

2. The dispatch method, whose name has the suffix `_async`. This method has a `void` return type. The first parameter is a smart pointer to an instance of the callback class described above. The remaining parameters comprise the `in` parameters of the operation, in the order of declaration.

For example, suppose we have defined the following operation:

```
interface I {
    ["amd"] int foo(short s, out long l);
};
```

The callback class generated for operation `foo` is shown below:

```
class AMD_I_foo : public ... {
public:
    void ice_response(Ice::Int, Ice::Long);
    void ice_exception(const Ice::Exception&);
    void ice_exception(const std::exception&);
    void ice_exception();
};
```

The dispatch method for asynchronous invocation of operation `foo` is generated as follows:

```
void foo_async(const AMD_I_fooPtr&, Ice::Short);
```

Java Mapping

The Java mapping emits the following code for each AMD operation:

1. A callback interface used by the implementation to notify the Ice run-time about the completion of an operation. The name of this interface is formed using the pattern `AMD_class_op`. For example, an operation named `foo` defined in interface `I` results in an interface named `AMD_I_foo`. The inter-

face is generated in the same scope as the interface or class containing the operation. Two methods are provided:

```
public void ice_response(<params>);
```

The `ice_response` method allows the server to report the successful completion of the operation. If the operation has a non-void return type, the first parameter to `ice_response` is the return value. Parameters corresponding to the operation's out parameters follow the return value, in the order of declaration.

```
public void ice_exception(java.lang.Exception ex);
```

The `ice_exception` method allows the server to report an exception. With respect to exceptions, there is less compile-time type safety in an AMD implementation because there is no `throws` clause on the dispatch method and any exception type could conceivably be passed to `ice_exception`. However, the Ice run-time validates the exception value using the same semantics as for synchronous dispatch (see Section 4.10.4).

2. The dispatch method, whose name has the suffix `_async`. This method has a `void` return type. The first parameter is a reference to an instance of the callback interface described above. The remaining parameters comprise the in parameters of the operation, in the order of declaration.

For example, suppose we have defined the following operation:

```
interface I {
    ["amd"] int foo(short s, out long l);
};
```

The callback interface generated for operation `foo` is shown below:

```
public interface AMD_I_foo {
    void ice_response(int __ret, long l);
    void ice_exception(java.lang.Exception ex);
}
```

The dispatch method for asynchronous invocation of operation `foo` is generated as follows:

```
void foo_async(AMD_I_foo __cb, short s);
```

C# Mapping

The C# mapping emits the following code for each AMD operation:

1. A callback interface used by the implementation to notify the Ice run-time about the completion of an operation. The name of this interface is formed using the pattern `AMD_class_op`. For example, an operation named `foo` defined in interface `I` results in an interface named `AMD_I_foo`. The interface is generated in the same scope as the interface or class containing the operation. Two methods are provided:

```
public void ice_response(<params>);
```

The `ice_response` method allows the server to report the successful completion of the operation. If the operation has a non-void return type, the first parameter to `ice_response` is the return value. Parameters corresponding to the operation's out parameters follow the return value, in the order of declaration.

```
public void ice_exception(System.Exception ex);
```

The `ice_exception` method allows the server to report an exception.

2. The dispatch method, whose name has the suffix `_async`. This method has a `void` return type. The first parameter is a reference to an instance of the callback interface described above. The remaining parameters comprise the in parameters of the operation, in the order of declaration.

For example, suppose we have defined the following operation:

```
interface I {
    ["amd"] int foo(short s, out long l);
};
```

The callback interface generated for operation `foo` is shown below:

```
public interface AMD_I_foo
{
    void ice_response(int __ret, long l);
    void ice_exception(System.Exception ex);
}
```

The dispatch method for asynchronous invocation of operation `foo` is generated as follows:

```
public abstract void foo_async(AMD_I_foo __cb, short s,
                               Ice.Current __current);
```

Visual Basic Mapping

The Visual Basic mapping emits the following code for each AMD operation:

1. A callback interface used by the implementation to notify the Ice run-time about the completion of an operation. The name of this interface is formed using the pattern `AMD_class_op`. For example, an operation named `foo` defined in interface `I` results in an interface named `AMD_I_foo`. The interface is generated in the same scope as the interface or class containing the operation. Two methods are provided:

```
Public Sub ice_response(<params>)
```

The `ice_response` method allows the server to report the successful completion of the operation. If the operation has a non-void return type, the first parameter to `ice_response` is the return value. Parameters corresponding to the operation's out parameters follow the return value, in the order of declaration.

```
Public Sub ice_exception(ByVal ex As System.Exception)
```

The `ice_exception` method allows the server to report an exception.

2. The dispatch method, whose name has the suffix `_async`. This method has a `void` return type. The first parameter is a reference to an instance of the callback interface described above. The remaining parameters comprise the in parameters of the operation, in the order of declaration.

For example, suppose we have defined the following operation:

```
interface I {
  ["amd"] int foo(short s, out long l);
};
```

The callback interface generated for operation `foo` is shown below:

```
Public Interface AMD_I_foo

  Sub ice_response(ByVal __ret As Integer, ByVal l As Long)
  Sub ice_exception(ex As _System.Exception)

End Interface
```

The dispatch method for asynchronous invocation of operation `foo` is generated as follows:

```
Sub foo_async(ByVal __cb As AMD_I_foo, _
  ByVal s As Short, _
  ByVal __current As Ice.Current)
```

Python Mapping

For each AMD operation, the Python mapping emits a dispatch method with the same name as the operation and the suffix `_async`. This method returns `None`. The first parameter is a reference to a callback object, as described below. The remaining parameters comprise the `in` parameters of the operation, in the order of declaration.

The callback object defines two methods:

- `def ice_response(self, <params>)`

The `ice_response` method allows the server to report the successful completion of the operation. If the operation has a non-void return type, the first parameter to `ice_response` is the return value. Parameters corresponding to the operation's `out` parameters follow the return value, in the order of declaration.

- `def ice_exception(self, ex)`

The `ice_exception` method allows the server to report an exception.

For example, suppose we have defined the following operation:

```
interface I {
    ["amd"] int foo(short s, out long l);
};
```

The callback interface generated for operation `foo` is shown below:

```
class ...
    #
    # Operation signatures.
    #
    # def ice_response(self, _result, l)
    # def ice_exception(self, ex)
```

The dispatch method for asynchronous invocation of operation `foo` is generated as follows:

```
def foo_async(self, __cb, s)
```

32.4.2 Exceptions

There are two processing contexts in which the logical implementation of an AMD operation may need to report an exception: the dispatch thread (i.e., the thread that receives the invocation), and the response thread (i.e., the thread that sends the response)². Although we recommend that the callback object be used to

report all exceptions to the client, it is legal for the implementation to raise an exception instead, but only from the dispatch thread.

As you would expect, an exception raised from a response thread cannot be caught by the Ice run-time; the application's run-time environment determines how such an exception is handled. Therefore, a response thread must ensure that it traps all exceptions and sends the appropriate response using the callback object. Otherwise, if a response thread is terminated by an uncaught exception, the request may never be completed and the client might wait indefinitely for a response.

Whether raised in a dispatch thread or reported via the callback object, user exceptions are validated as described in Section 4.10.2, and local exceptions may undergo the translation described in Section 4.10.4.

32.4.3 Example

In this section, we continue the example we started in Section 32.3.3, but first we must modify the operation to add AMD metadata:

```
module Demo {
    sequence<float> Row;
    sequence<Row> Grid;

    exception RangeError {};

    interface Model {
        ["ami", "amd"] Grid interpolate(Grid data, float factor)
            throws RangeError;
    };
};
```

The sections below provide implementations of the `Model` interface in C++, Java, C#, Visual Basic, and Python.

C++ Servant

Our servant class derives from `Demo::Model` and supplies a definition for the `interpolate_async` method:

2. These are not necessarily two different threads: the response can also be sent from the dispatch thread if desired.

```

class ModelI : virtual public Demo::Model,
               virtual public IceUtil::Mutex {
public:
    virtual void interpolate_async(
        const Demo::AMD_Model_interpolatePtr&,
        const Demo::Grid&,
        Ice::Float,
        const Ice::Current&);

private:
    std::list<JobPtr> _jobs;
};

```

The implementation of `interpolate_async` uses synchronization to safely record the callback object and arguments in a `Job` that is added to a queue:

```

void ModelI::interpolate_async(
    const Demo::AMD_Model_interpolatePtr& cb,
    const Demo::Grid& data,
    Ice::Float factor,
    const Ice::Current& current)
{
    IceUtil::Mutex::Lock sync(*this);
    JobPtr job = new Job(cb, data, factor);
    _jobs.push_back(job);
}

```

After queuing the information, the operation returns control to the Ice run-time, making the dispatch thread available to process another request. An application thread removes the next `Job` from the queue and invokes `execute` to perform the interpolation. `Job` is defined as follows:

```

class Job : public IceUtil::Shared {
public:
    Job(
        const Demo::AMD_Model_interpolatePtr&,
        const Demo::Grid&,
        Ice::Float);
    void execute();

private:
    bool interpolateGrid();

    Demo::AMD_Model_interpolatePtr _cb;
};

```

```

    Demo::Grid _grid;
    Ice::Float _factor;
};
typedef IceUtil::Handle<Job> JobPtr;

```

The implementation of `execute` uses `interpolateGrid` (not shown) to perform the computational work:

```

Job::Job(
    const Demo::AMD_Model_interpolatePtr& cb,
    const Demo::Grid& grid,
    Ice::Float factor) :
    _cb(cb), _grid(grid), _factor(factor)
{
}

void Job::execute()
{
    if(!interpolateGrid()) {
        _cb->ice_exception(Demo::RangeError());
        return;
    }
    _cb->ice_response(_grid);
}

```

If `interpolateGrid` returns `false`, then `ice_exception` is invoked to indicate that a range error has occurred. The `return` statement following the call to `ice_exception` is necessary because `ice_exception` does not throw an exception; it only marshals the exception argument and sends it to the client.

If interpolation was successful, `ice_response` is called to send the modified grid back to the client.

Java Servant

Our servant class derives from `Demo._ModelDisp` and supplies a definition for the `interpolate_async` method that creates a `Job` to hold the callback object and arguments, and adds the `Job` to a queue. The method is synchronized to guard access to the queue:

```

public final class ModelI extends Demo._ModelDisp {
    synchronized public void interpolate_async(
        Demo.AMD_Model_interpolate cb,
        float[][] data,
        float factor,
        Ice.Current current)
        throws RangeError
}

```



```

    {
        _jobs.add(new Job(cb, data, factor));
    }

    java.util.LinkedList _jobs = new java.util.LinkedList();
}

```

After queuing the information, the operation returns control to the Ice run-time, making the dispatch thread available to process another request. An application thread removes the next `Job` from the queue and invokes `execute`, which uses `interpolateGrid` (not shown) to perform the computational work:

```

class Job {
    Job(Demo.AMD_Model_interpolate cb,
        float[][] grid,
        float factor)
    {
        _cb = cb;
        _grid = grid;
        _factor = factor;
    }

    void execute()
    {
        if(!interpolateGrid()) {
            _cb.ice_exception(new Demo.RangeError());
            return;
        }
        _cb.ice_response(_grid);
    }

    private boolean interpolateGrid() {
        // ...
    }

    private Demo.AMD_Model_interpolate _cb;
    private float[][] _grid;
    private float _factor;
}

```

If `interpolateGrid` returns `false`, then `ice_exception` is invoked to indicate that a range error has occurred. The `return` statement following the call to `ice_exception` is necessary because `ice_exception` does not throw an exception; it only marshals the exception argument and sends it to the client.

If interpolation was successful, `ice_response` is called to send the modified grid back to the client.

C# Servant

Our servant class derives from `Demo._ModelDisp` and supplies a definition for the `interpolate_async` method that creates a `Job` to hold the callback object and arguments, and adds the `Job` to a queue. The method uses a lock statement to guard access to the queue:

```
public class ModelI : Demo.ModelDisp_
{
    public override void interpolate_async(
        Demo.AMD_Model_interpolate cb,
        float[][] data,
        float factor,
        Ice.Current current)
    {
        lock(this)
        {
            _jobs.Add(new Job(cb, data, factor));
        }
    }

    private System.Collections.ArrayList _jobs
        = new System.Collections.ArrayList();
}
```

After queuing the information, the operation returns control to the Ice run-time, making the dispatch thread available to process another request. An application thread removes the next `Job` from the queue and invokes `execute`, which uses `interpolateGrid` (not shown) to perform the computational work:

```
public class Job {
    public Job(Demo.AMD_Model_interpolate cb,
        float[][] grid, float factor)
    {
        _cb = cb;
        _grid = grid;
        _factor = factor;
    }

    public void execute()
    {
        if (!interpolateGrid()) {
            _cb.ice_exception(new Demo.RangeError());
        }
    }
}
```

```

        return;
    }
    _cb.ice_response(_grid);
}

private boolean interpolateGrid()
{
    // ...
}

private Demo.AMD_Model_interpolate _cb;
private float[][] _grid;
private float _factor;
}

```

If `interpolateGrid` returns `false`, then `ice_exception` is invoked to indicate that a range error has occurred. The return statement following the call to `ice_exception` is necessary because `ice_exception` does not throw an exception; it only marshals the exception argument and sends it to the client.

If interpolation was successful, `ice_response` is called to send the modified grid back to the client.

Visual Basic Servant

Our servant class derives from `Demo._ModelDisp` and supplies a definition for the `interpolate_async` method that creates a `Job` to hold the callback object and arguments, and adds the `Job` to a queue. The method uses a lock statement to guard access to the queue:

```

Public Class ModelI
    Inherits Demo.ModelDisp_

    Public Overrides Sub interpolate_async( _
        ByVal cb As Demo.AMD_Model_interpolate, _
        ByVal data As Single(), _
        ByVal factor As Single, _
        ByVal current As Ice.Current)

        SyncLock Me
            _jobs.Add(New Job(cb, data, factor))
        End SyncLock
    }
}

```

```

Private _jobs As System.Collections.ArrayList _
    = New System.Collections.ArrayList

```

```
End Class
```

After queuing the information, the operation returns control to the Ice run-time, making the dispatch thread available to process another request. An application thread removes the next Job from the queue and invokes `execute`, which uses `interpolateGrid` (not shown) to perform the computational work:

```
Public Class Job
```

```

Public Sub New(ByVal cb As Demo.AMD_Model_interpolate, _
              ByVal grid As Single()(), _
              float factor)

```

```

    _cb = cb
    _grid = grid
    _factor = factor

```

```
End Sub
```

```

Public Sub execute()
    if Not interpolateGrid() Then
        _cb.ice_exception(New Demo.RangeError)
        Return
    End If
    _cb.ice_response(_grid)
End Sub

```

```

Private Function interpolateGrid() As Boolean
    ' ...
End Function

```

```

Private _cb As Demo.AMD_Model_interpolate
Private _grid As Single()()
private _factor As Single

```

```
End Class
```

If `interpolateGrid` returns `false`, then `ice_exception` is invoked to indicate that a range error has occurred. The return statement following the call to `ice_exception` is necessary because `ice_exception` does not throw an exception; it only marshals the exception argument and sends it to the client.

If interpolation was successful, `ice_response` is called to send the modified grid back to the client.

Python Servant

Our servant class derives from `Demo.Model` and supplies a definition for the `interpolate_async` method that creates a `Job` to hold the callback object and arguments, and adds the `Job` to a queue. The method uses a lock to guard access to the queue:

```
class ModelI(Demo.Model):
    def __init__(self):
        self._mutex = threading.Lock()
        self._jobs = []

    def interpolate_async(self, cb, data, factor, current=None):
        self._mutex.acquire()
        try:
            self._jobs.append(Job(cb, data, factor))
        finally:
            self._mutex.release()
```

After queuing the information, the operation returns control to the Ice run-time, making the dispatch thread available to process another request. An application thread removes the next `Job` from the queue and invokes `execute`, which uses `interpolateGrid` (not shown) to perform the computational work:

```
class Job(object):
    def __init__(self, cb, grid, factor):
        self._cb = cb
        self._grid = grid
        self._factor = factor

    def execute(self):
        if not self.interpolateGrid():
            self._cb.ice_exception(Demo.RangeError())
            return
        self._cb.ice_response(self._grid)

    def interpolateGrid(self):
        # ...
```

If `interpolateGrid` returns `False`, then `ice_exception` is invoked to indicate that a range error has occurred. The return statement following the call to `ice_exception` is necessary because `ice_exception` does not throw an exception; it only marshals the exception argument and sends it to the client.

If interpolation was successful, `ice_response` is called to send the modified grid back to the client.

32.5 Summary

Synchronous remote invocations are a natural extension of local method calls that leverage the programmer's experience with object-oriented programming and ease the learning curve for programmers who are new to distributed application development. However, the blocking nature of synchronous invocations makes some application tasks more difficult, or even impossible, therefore Ice provides a straightforward interface to its asynchronous facilities.

Using asynchronous method invocation, a calling thread is able to invoke an operation and regain control immediately, without blocking while the operation is in progress. When the results are received, the Ice run-time notifies the application via a callback.

Similarly, asynchronous method dispatch allows a servant to send the results of an operation at any time, not necessarily within the operation implementation. A servant can improve scalability and conserve thread resources by queuing time-consuming requests for processing at a later time.

Chapter 33

Facets and Versioning

33.1 Introduction

Facets provide a general-purpose mechanism for non-intrusively extending the type system of an application. This is particularly useful for versioning an application. Section 33.2 introduces the facet concept and presents the relevant APIs. Section 33.3 presents a few traditional approaches to versioning and their problems. Sections 33.4 to 33.6 show how to use facets to implement versioning, and Section 33.7 discusses design choices when adding versioning to a system.

33.2 Concept and APIs

Up to this point, we have presented an Ice object as a single conceptual entity, that is, as an object with a single most-derived interface and a single identity, with the object being implemented by a single servant. However, an Ice object is more

correctly viewed as a collection of one or more sub-objects known as *facets*, as shown in Figure 33.1.

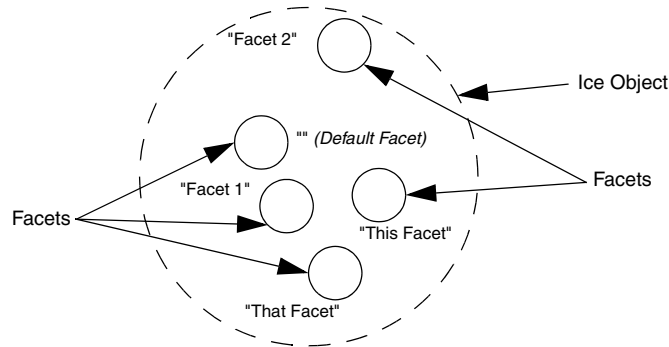

Figure 33.1. An Ice object with five facets sharing a single object identity.

Figure 33.1 shows a single Ice object with five facets. Each facet has a name, known as the *facet name*. Within a single Ice object, all facets must have unique names. Facet names are arbitrary strings that are assigned by the server that implements an Ice object. A facet with an empty facet name is legal and known as the *default facet*. Unless you arrange otherwise, an Ice object has a single default facet; by default, operations that involve Ice objects and servants operate on the default facet.

Note that all the facets of an Ice object share the same single identity, but have different facet names. Recall the definition of `Ice::Current` we saw in Section 31.6 once more:

```
module Ice {
    local dictionary<string, string> Context;

    enum OperationMode { Normal, \Nonmutating, \Idempotent };

    local struct Current {
        ObjectAdapter  adapter;
        Identity       id;
        string         facet;
        string         operation;
        OperationMode  mode;
    };
};
```



```

        Context      ctx;
        int          requestId;
    };
};

```

By definition, if two facets have the same `id` field, they are part of the same Ice object. Also by definition, if two facets have the same `id` field, their facet fields have different values.

Even though Ice objects usually consist of just the default facet, it is entirely legal for an Ice object to consist of facets that all have non-empty names (that is, it is legal for an Ice object not to have a default facet).

Each facet has a single most-derived interface. There is no need for the interface types of the facets of an Ice object to be unique. It is legal for two facets of an Ice object to implement the same most-derived interface.

Each facet is implemented by a servant. All the usual implementation techniques for servants are available to implement facets—for example, you can implement a facet using a servant locator. Typically, each facet of an Ice object has a separate servant, although, if two facets of an Ice object have the same type, they can also be implemented by a single servant (for example, using a default servant, as described in Section 31.8.2).

33.2.1 Server-Side Facet Operations

On the server side, the object adapter offers a number of operations to support facets:

```

namespace Ice {
    dictionary<string, Object> FacetMap;

    local interface ObjectAdapter {
        Object* addFacet(Object servant, Identity id, string facet);
        Object* addFacetWithUUID(Object servant, string facet);
        Object  removeFacet(Identity id, string facet);
        Object  findFacet(Identity id, string facet);

        FacetMap findAllFacets(Identity id);
        FacetMap removeAllFacets(Identity id);
        // ...
    };
};

```

These operations have the same semantics as the corresponding “normal” operations (`add`, `addWithUUID`, `remove`, and `find`), but also accept a facet name. The

corresponding “normal” operations are simply convenience operations that supply an empty facet name. For example, `remove(id)` is equivalent to `removeFacet(id, "")`, that is, `remove(id)` operates on the default facet.

`findAllFacets` returns a dictionary of `<facet-name, servant>` pairs that contains all the facets for the given identity.

`removeAllFacets` removes all facets for a given identity from the active servant map, that is, it removes the corresponding Ice object entirely. The operation returns a dictionary of `<facet-name, servant>` pairs that contains all the removed facets.

These operations are sufficient for the server to create Ice objects with any number of facets. For example, assume that we have the following Slice definitions:

```
module Filesystem {
    // ...

    interface File extends Node {
        nonmutating Lines read();
        idempotent void write(Lines text) throws GenericError;
    };
};

module FilesystemExtensions {
    // ...

    class DateTime extends TimeOfDay {
        // ...
    };

    struct Times {
        DateTime createdDate;
        DateTime accessedDate;
        DateTime modifiedDate;
    };

    interface Stat {
        nonmutating Times getTimes();
    };
};
```

Here, we have a `File` interface that provides operations to read and write a file, and a `Stat` interface that provides access to the file creation, access, and modification time. (Note that the `Stat` interface is defined in a different module and could

also be defined in a different source file.) If the server wants to create an Ice object that contains a `File` instance as the default facet and a `Stat` instance that provides access to the time details of the file, it could use:

```
// Create a File instance.
//
Filesystem::FilePtr file = new FileI();

// Create a Stat instance.
//
FilesystemExceptions::DateTimePtr dt
    = new FilesystemExtensions::DateTime();
FilesystemExtensions::Times times;
times.createdDate = dt;
times.accessedDate = dt;
times.modifiedDate = dt;
FilesystemExtensions::StatPtr stat = new StatI(times);

// Register the File instance as the default facet.
//
Filesystem::FilePrx filePrx = myAdapter->addWithUUID(file);

// Register the Stat instance as a facet with name "Stat".
//
myAdapter->addFacet(stat, filePrx->ice_getIdentity(), "Stat");
```

The first few lines simply create and initialize a `FileI` and `StatI` instance. (The details of this do not matter here.) All the action is in the last two statements:

```
Filesystem::FilePrx filePrx = myAdapter->addWithUUID(file);
myAdapter->addFacet(stat, filePrx->ice_getIdentity(), "Stat");
```

This registers the `FileI` instance with the object adapter as usual. (In this case, we let the Ice run time generate a UUID as the object identity.) Because we are calling `addWithUUID` (as opposed to `addFacetWithUUID`), the instance becomes the default facet.

The second line adds a facet to the instance with the facet name `Stat`. Note that we call `ice_getIdentity` on the `File` proxy to pass an object identity to `addFacet`. This guarantees that the two facets share the same object identity.

Note that, in general, it is a good idea to use `ice_getIdentity` to obtain the identity of an existing facet when adding a new facet. That way, it is guaranteed that the facets share the same identity. (If you accidentally pass a different identity to `addFacet`, you will not add a facet to an existing Ice object, but instead register a new Ice object; using `ice_getIdentity` makes this mistake impossible.)

33.2.2 Client-Side Facet Operations

On the client side, which facet a request is addressed to is implicit in the proxy that is used to send the request. For an application that does not use facets, the facet name is always empty so, by default, requests are sent to the default facet.

The client can use a `checkedCast` to obtain a proxy for a particular facet. For example, assume that the client obtains a proxy to a `File` instance as shown in Section 33.2.1. The client can cast between the `File` facet and the `Stat` facet (and back) as follows:

```
// Get a File proxy.
//
Filesystem::FilePrx file = ...;

// Get the Stat facet.
//
FilesystemExtensions::StatPrx stat
    = FilesystemExtensions::StatPrx::checkedCast(file, "Stat");

// Go back from the Stat facet to the File facet.
//
Filesystem::FilePrx file2
    = Filesystem::FilePrx::checkedCast(stat, "");

assert(file2 == file); // The two proxies are identical.
```

This example illustrates that, given any facet of an Ice object, the client can navigate to any other facet by using a `checkedCast` with the facet name.

If an Ice object does not provide the specified facet, `checkedCast` returns null:

```
FilesystemExtensions::StatPrx stat
    = FilesystemExtensions::StatPrx::checkedCast(file, "Stat");

if (!stat) {
    // No Stat facet on this object, handle error...
} else {
    FilesystemExtensions::Times times = stat->getTimes();

    // Use times struct...
}
```

Note that `checkedCast` also returns a null proxy if a facet exists, but the cast is to the wrong type. For example:

```

// Get a File proxy.
//
filesystem::FilePrx file = ...;

// Cast to the wrong type.
//
SomeTypePrx prx = SomeTypePrx::checkedCast(file, "Stat");

assert(!prx); // checkedCast returns a null proxy.

```

If you want to distinguish between non-existence of a facet and the facet being of the incorrect type, you can first obtain the facet as type `Object` and then down-cast to the correct type:

```

// Get a File proxy.
//
filesystem::FilePrx file = ...;

// Get the facet as type Object.
//
Ice::ObjectPrx obj = Ice::ObjectPrx::checkedCast(file, "Stat");
if (!obj) {
    // No facet with name "Stat" on this Ice object.
} else {
    filesystemExtensions::StatPrx stat =
        filesystemExtensions::StatPrx::checkedCast(file);
    if (!stat) {
        // There is a facet with name "Stat", but it is not
        // of type filesystemExtensions::Stat.
    } else {
        // Use stat...
    }
}

```

This last example also illustrates that

```
StatPrx::checkedCast(prx, "")
```

is *not* the same as

```
StatPrx::checkedCast(prx)
```

The first version explicitly requests a cast to the default facet. This means that the Ice run time first looks for a facet with the empty name and then attempts to down-cast that facet (if it exists) to the type `Stat`.

The second version requests a down-cast that *preserves* whatever facet is currently effective in the proxy. For example, if the `prx` proxy currently holds the

facet name “Joe”, then (if `prx` points at an object of type `Stat`) the run time returns a proxy of type `StatPrx` that also stores the facet name “Joe”.

It follows that, to navigate between facets, you must always use the two-argument version of `checkedCast`, whereas, to down-cast to another type while preserving the facet name, you must always use the single-argument version of `checkedCast`.

You can always check what the current facet of a proxy is by calling `ice_getFacet`:

```
Ice::ObjectPrx obj = ...;
```

```
cout << obj->ice_getFacet() << endl; // Print facet name
```

This prints the facet name. (For the default facet, `ice_getFacet` returns the empty string.)

33.2.3 Exception Semantics

As we pointed out on page 111, `ObjectNotExistException` and `FacetNotExistException` have the following semantics:

- `ObjectNotExistException`

This exception is raised only if no facets exist at all for a given object identity.

- `FacetNotExistException`

This exception is raised only if at least one facet exists for a given object identity, but not the specific facet that is the target of an operation invocation.

If you are using servant locators (see Section 31.7) or default servants (Section 31.8.2), you must take care to preserve these semantics. In particular, if you return null from a servant locator’s `locate` operation, this appears to the client as an `ObjectNotExistException`. If the object identity for a request is known (that is, there is at least one facet with that identity), but no facet with the specified name exists, you must explicitly throw a `FacetNotExistException` from `activate` instead of simply returning null.

33.3 The Versioning Problem

Once you have developed and deployed a distributed application, and once the application has been in use for some time, it is likely that you will want to make some changes to the application. For example, you may want to add new function-

ality to a later version of the application, or you may want to change some existing aspect of the application. Of course, ideally, such changes are accomplished without breaking already deployed software, that is, the changes should be backward compatible. Evolving an application in this way is generally known as *versioning*.

Versioning is an aspect that previous middleware technologies have addressed only poorly (if at all). One of the purposes of facets is to allow you to cleanly create new versions of an application without compromising compatibility with older, already deployed versions.

33.3.1 Versioning by Addition

Suppose that we have deployed our file system application and want to add extra functionality to a new version. Specifically, let us assume that the original version (version 1) only provides the basic functionality to use files, but does not provide extra information, such as the modification date or the file size. The question is then, how can we upgrade the existing application with this new functionality? Here is a small excerpt of the original (version 1) Slice definitions once more:

```
// Version 1

module Filesystem {
    // ...

    interface File extends Node {
        nonmutating Lines read();
        idempotent void write(Lines text) throws GenericError;
    };
};
```

Your first attempt at upgrading the application might look as follows:

```
// Version 2

module Filesystem {
    // ...

    class DateTime extends TimeOfDay { // New in version 2
        // ...
    };

    struct Times { // New in version 2
        DateTime createdDate;
    };
};
```

```
        DateTime accessedDate;
        DateTime modifiedDate;
    };

    interface File extends Node {
        nonmutating Lines read();
        idempotent void write(Lines text) throws GenericError;

        nonmutating Times getTimes(); // New in version 2
    };
};
```

Note that the version 2 definition does not change anything that was present in version 1; instead, it only adds two new types and adds an operation to the `File` interface. Version 1 clients can continue to work with both version 1 and version 2 `File` objects because version 1 clients do not know about the `getTimes` operation and therefore will not call it; version 2 clients, on the other hand, can take advantage of the new functionality. The reason this works is that the Ice protocol invokes an operation by sending the operation name as a string on the wire (rather than using an ordinal number or hash value to identify the operation). Ice guarantees that any future version of the protocol will retain this behavior, so it is safe to add a new operation to an existing interface without recompiling all clients.

However, this approach contains a pitfall: the tacit assumption built into this approach is that no version 2 client will ever use a version 1 object. If the assumption is violated (that is, a version 2 client uses a version 1 object), the version 2 client will receive an `OperationNotExistException` when it invokes the new `getTimes` operation because that operation is supported only by version 2 objects.

Whether you can make this assumption to make depends on your application. In some cases, it may be possible to ensure that version 2 clients will never access a version 1 object, for example, by simultaneously upgrading all server's from version 1 to version 2, or by taking advantage of application-specific constraints that ensure that version 2 clients only contact version 2 object. However, for some applications, doing this is impractical.

Note that you could write version 2 clients to catch and react to an `OperationNotExistException` when they invoke the `getTimes` operation: if the operation succeeds, the client is dealing with a version 2 object, and if the operation raises `OperationNotExistsException`, the client is dealing with a version 1 object. However, doing this can be rather intrusive to the code, loses static type safety, and is rather inelegant. (There is no other way to tell a version 1 object from a version 2 object because both versions have the same type ID.)

In general, versioning addition makes sense when you need to add an operation or two to an interface, and you can be sure that version 2 clients do not access version 1 objects. Otherwise, other approaches are needed.

33.3.2 Versioning by Derivation

Given that the limitations of the preceding approach, you may decide to upgrade the application as follows instead:

```
module Filesystem {      // Version 1
    // ...

    interface File extends Node {
        nonmutating Lines read();
        idempotent void write(Lines text) throws GenericError;
    };
};

module FilesystemV2 {   // New in version 2
    // ...

    class DateTime extends TimeOfDay {
        // ...
    };

    struct Times {
        DateTime createdDate;
        DateTime accessedDate;
        DateTime modifiedDate;
    };

    interface File extends Filesystem::File {
        nonmutating Times getTimes();
    };
};
```

The idea is to present the new functionality in an interface that is derived from the version 1 interface. The version 1 types are unchanged and the new functionality is presented via new types that are backward compatible: a version 2 `File` object can be passed where a version 1 `File` object is expected because `FilesystemV2::File` is derived from `Filesystem::File`. Even better, if a version 2 component of the system receives a proxy of formal type `Filesystem::File`, it can determine at run time whether the actual run-time type is

`FilesystemV2::File` by attempting a down-cast: if the down-cast succeeds, it is dealing with a version 2 object; if the down-cast fails, it is dealing with a version 1 object. This is essentially the same as versioning by addition, but it is cleaner as far as the type system is concerned because the two different versions can be distinguished via their type IDs.

At this point, you may think that versioning by derivation solves the problem elegantly. Unfortunately, the truth turns out to be a little harsher:

- As the system evolves further, and new versions are added, each new version adds a level of derivation to the inheritance tree. After a few versions, particularly if your application also uses inheritance for its own purposes, the resulting inheritance graph very quickly turns into a complex mess. (This becomes most obvious if the application uses multiple inheritance—after a few versioning steps, the resulting inheritance hierarchy is usually so complex that it exceeds the ability of humans to comprehend it.)
- Real-life versioning requirements are not as simple as adding a new operation to an object. Frequently, versioning requires changes such as adding a field to a structure, adding a parameter to an operation, changing the type of a field or a parameter, renaming an operation, or adding a new exception to an operation. However, versioning by derivation (and versioning by addition) can handle none of these changes.
- Quite often, functionality that is present in an earlier version needs to be removed for a later version (for example, because the older functionality has been supplanted by a different mechanism or turned out to be inappropriate). However, there is no way to *remove* functionality through versioning by derivation. The best you can do is to re-implement a base operation in the derived implementation of an interface and throw an exception. However, the deprecated operation may not have an exception specification, or if it does, the exception specification may not include suitable exception. And, of course, doing this perverts the type system: after all, if an interface has an operation that throws an exception whenever the operation is invoked, why does the operation exist in the first place?

There are other, more subtle reasons why versioning by derivation is unsuitable in real-life situations. Suffice it to say here that experience has shown the idea to be unworkable: projects that have tried to use this technique for anything but the most trivial versioning requirements have inevitably failed.

33.3.3 Explicit Versioning

Yet another twist on the versioning theme is to explicitly version everything, for example:

```
module Filesystem {
    // ...

    interface FileV1 extends NodeV1 {
        nonmutating LinesV1 read();
        idempotent void write(LinesV1 text) throws GenericErrorV1;
    };

    class DateTimeV2 extends TimeOfDayV2 {
        // ...
    };

    struct TimesV2 {
        DateTimeV2 createdDate;
        DateTimeV2 accessedDate;
        DateTimeV2 modifiedDate;
    };

    interface FileV2 extends NodeV2 {
        nonmutating LinesV2 read();
        idempotent void write(LinesV2 text) throws GenericErrorV2;
        nonmutating TimesV2 getTimes();
    };
};
```

In essence, this approach creates as many separate definitions of each data type, interface, and operation as there are versions. It is easy to see that this approach does not work very well:

- Because, at the time version 1 is produced, it is unknown what might need to change for version 2 and later versions, *everything* has to be tagged with a version number. This very quickly leads to an incomprehensible type system.
- Because every version uses its own set of separate types, there is no type compatibility. For example, a version 2 type cannot be passed where a version 1 type is expected without explicit copying.
- Client code must be written to explicitly deal with each separate version. This pollutes the source code at all points where a remote call is made or a Slice data type is passed; the resulting code quickly becomes incomprehensible.

Other approaches, such as placing the definitions for each version into a separate module (that is, versioning the enclosing module instead of each individual type) do little to mitigate these problems; the type incompatibility issues and the need to explicitly deal with versioning remain.

33.4 Versioning with Facets

A negative aspect of all the approaches in Section 33.3 is that they change the type system in intrusive ways. In turn, this forces unacceptable programming contortions on clients. Facets allow you to solve the versioning problem more elegantly because they do not change an existing type system but extend it instead. We already saw this approach in operation on page 940, where we added date information about a file to our file system application without disturbing any of the existing definitions.

In the most general sense, facets provide a mechanism for implementing multiple interfaces for a single object. The key point is that, to add a new interface to an object, none of the existing definitions have to be touched, so no compatibility issues can arise. More importantly, the decision as to which facet to use is made at run time instead of at compile time. In effect, facets implement a form of late binding and, therefore, are coupled to the type system more loosely than any of the previous approaches.

Used judiciously, facets can handle versioning requirements more elegantly than other mechanisms. Apart from the straight extension of an interface as shown in Section 33.2.1, facets can also be used for more complex changes. For example, if you need to change the parameters of an operation or modify the fields of a structure, you can create a new facet with operations that operate on the changed data types. Quite often, the implementation of a version 2 facet in the server can even re-use much of the version 1 functionality, by delegating some version 2 operations to a version 1 implementation.

33.5 Facet Selection

Given that we have decided to extend an application with facets, we have to deal with the question of how clients select the correct facet. The answer typically involves an explicit selection of a facet sometime during client start-up. For example, in our file system application, clients always begin their interactions

with the file system by creating a proxy to the root directory. Let us assume that our versioning requirements have led to version 1 and version 2 definitions of directories as follows:

```

module Filesystem { // Original version
    // ...

    interface Directory extends Node {
        nonmutating NodeSeq list();
        // ...
    };
};

module FilesystemV2 {
    // ...

    enum NodeType { Directory, File };

    class NodeDetails {
        NodeType type;
        string name;
        DateTime createdTime;
        DateTime accessedTime;
        DateTime modifiedTime;
        // ...
    };

    interface Directory extends Filesystem::Node {
        nonmutating NodeDetailsSeq list();
        // ...
    };
};

```

In this case, the semantics of the `list` operation have changed in version 2. A version 1 client uses the following code to obtain a proxy to the root directory:

```

// Create a proxy for the root directory
//
Ice::ObjectPrx base
    = communicator()->stringToProxy("RootDir:default -p 10000");
if (!base)
    throw "Could not create proxy";

// Down-cast the proxy to a Directory proxy
//

```

```

Filesystem::DirectoryPrx rootDir
    = Filesystem::DirectoryPrx::checkedCast(base);
if (!rootDir)
    throw "Invalid proxy";

```

For a version 2 client, the bootstrap code is almost identical—instead of down-casting to `Filesystem::Directory`, the client selects the “V2” facet during the down-cast to the type `FilesystemV2::Directory`:

```

// Create a proxy for the root directory
//
Ice::ObjectPrx base
    = communicator()->stringToProxy("RootDir:default -p 10000");
if (!base)
    throw "Could not create proxy";

// Down-cast the proxy to a V2 Directory proxy
//
FilesystemV2::DirectoryPrx rootDir
    = FilesystemV2::DirectoryPrx::checkedCast(base, "V2");
if (!rootDir)
    throw "Invalid proxy";

```

Of course, we can also create a client that can deal with both version 1 and version 2 directories: if the down-cast to version 2 fails, the client is dealing with a version 1 server and can adjust its behavior accordingly.

33.6 Behavioral Versioning

On occasion, versioning requires changes in behavior that are not manifest in the interface of the system. For example, we may have an operation that performs some work, such as:

```

interface Foo {
    void doSomething();
};

```

The same operation on the same interface exists in both versions, but the *behavior* of `doSomething` in version 2 differs from that in version 1. The question is, how do we best deal with such behavioral changes?

Of course, one option is to simply create a version 2 facet and to carry that facet alongside the original version 1 facet. For example:

```
module V2 {  
    interface Foo { // V2 facet  
        void doSomething();  
    };  
};
```

This works fine, as far as it goes: a version 2 client asks for the “V2” facet and then calls `doSomething` to get the desired effect. Depending on your circumstances, this approach may be entirely reasonable. However, if there are such behavioral changes on several interfaces, the approach leads to a more complex type system because it duplicates each interface with such a change.

A better alternative can be to create two facets of the same type, but have the implementation of those facets differ. With this approach, both facets are of type `::Foo::doSomething`. However, the implementation of `doSomething` checks which facet was used to invoke the request and adjusts its behavior accordingly:

```
void  
FooI::doSomething(const Ice::Current& c)  
{  
    if(c.facet == "V2") {  
        // Provide version 2 behavior...  
    } else {  
        // Provide version 1 behavior...  
    }  
}
```

This approach avoids creating separate types for the different behaviors, but has the disadvantage that version 1 and version 2 objects are no longer distinguishable to the type system. This can matter if, for example, an operation accepts a `Foo` proxy as a parameter. Let us assume that we also have an interface `FooProcessor` as follows:

```
interface FooProcessor {  
    void processFoo(Foo* w);  
};
```

If `FooProcessor` also exists as a version 1 and version 2 facet, we must deal with the question of what should happen if a version 1 `Foo` proxy is passed to a version 2 `processFoo` operation because, at the type level, there is nothing to prevent this from happening.

You have two options to deal with this situation:

- Define working semantics for mixed-version invocations. In this case, you must come up with sensible system behavior for all possible combinations of versions.
- If some of the mixed-version combinations are disallowed (such as passing a version 1 Foo proxy to a version 2 processFoo operation), you can detect the version mismatch in the server by looking at the `Current::facet` member and throwing an exception to indicate a version mismatch. Simultaneously, write your clients to ensure they only pass a permissible version to `processFoo`. Clients can ensure this by checking the facet name of a proxy before passing it to `processFoo` and, if there is a version mismatch, changing either the Foo proxy or the FooProcessor proxy to a matching facet:

```

FooPrx fooPrx foo = ...;           // Get a Foo...
FooProcessorPrx fooP = ...;       // Get a FooProcessor...

string fooFacet = foo->ice_getFacet();
string fooPFacet = fooP->ice_getFacet();
if(fooFacet != fooPFacet) {
    if(fooPFacet == "V2") {
        error("Cannot pass a V1 Foo to a V2 FooProcessor");
    } else {
        // Upgrade FooProcessor from V1 to V2
        fooP = FooProcessorPrx::checkedCast(fooP, "V2");
        if(!fooP) {
            error("FooProcessor does not have a V2 facet");
        } else {
            fooP->processFoo(foo);
        }
    }
}

```

33.7 Design Considerations

Facets allow you to add versioning to a system, but they are merely a mechanism, not a solution. You still have to make a decision as to how to version something. For example, at some point, you may want to deprecate a previous version's behavior; at that point, you must make a decision how to handle requests for the deprecated version. For behavioral changes, you have to decide whether to use separate interfaces or use facets with the same interface. And, of course, you must have compatibility rules to determine what should happen if, for example, a

version 1 object is passed to an operation that implements version 2 behavior. In other words, facets cannot do your thinking for you and are no panacea for the versioning problem.

The biggest advantage of facets is also the biggest drawback: facets delay the decision about the types that are used and their behavior until run time. While this provides a lot of flexibility, it is significantly less type safe than having explicit types that can be statically checked at compile time: if you have a problem relating to incorrect facet selection, the problem will be visible only at run time and, moreover, will be visible only if you actually execute the code that contains the problem, and execute it with just the right data.

Another danger of facets is to abuse them. As an extreme example, here is an interface that provides an arbitrary collection of objects of arbitrary type:

```
interface Collection {};
```

Even though this interface is empty, it can provide access to an unlimited number of objects of arbitrary type in the form of facets. While this example is extreme, it illustrates the design tension that is created by facets: you must decide, for a given versioning problem, how and at what point of the type hierarchy to split off a facet that deals with the changed functionality. The temptation may be to “simply add another facet” and be done with it. However, if you do that, your objects are in danger of being nothing more than loose conglomerates of facets without rhyme or reason, and with little visibility of their relationships in the type system.

In object modeling terms, the relationship among facets is weaker than an *is-a* relationship (because facets are often not type compatible among each other). On the other hand, the relationship among facets is stronger than a *has-a* relationship (because all facets of an Ice object share the same object identity).

It is probably best to treat the relationship of a facet to its Ice object with the same respect as an inheritance relationship: if you were omniscient and could have designed your system for all current and future versions simultaneously, many of the operations that end up on separate facets would probably have been in the same interface instead. In other words, adding a facet to an Ice object most often implies that the facet has an *is-partly-a* relationship with its Ice object. In particular, if you think about the life cycle of an Ice object and find that, when an Ice object is deleted, all its facets must be deleted, this is a strong indication of a correct design. On the other hand, if you find that, at various times during an Ice object’s life cycle, it has a varying number of facets of varying types, that is a good indication that you are using facets incorrectly.

Ultimately, the decision comes down to deciding whether the trade-off of static type safety versus dynamic type safety is worth the convenience and back-

ward compatibility. The answer depends strongly on the design of your system and individual requirements, so we can only give broad advice here. Finally, there will be a point where no amount of facet trickery will get past the point when “yet one more version will be the straw that breaks the camel’s back.” At that point, it is time to stop supporting older versions and to redesign the system.

33.8 Summary

Facets provide a way to extend a type system by loosely coupling new type instances to existing ones. This shifts the type selection process from compile to run time and implements a form of late binding. Due to their loose coupling among each other, facets are better suited to solve the versioning problem than other approaches. However, facets are not a panacea that would solve the versioning problem for free, and careful design is still necessary to come up with versioned systems that remain understandable and maintain consistent semantics.

Chapter 34

The Ice Protocol

34.1 Chapter Overview

The Ice protocol definition consists of three major parts:

- a set of data encoding rules that determine how the various data types are serialized
- a number of message types that are interchanged between client and server, together with rules as to what message is to be sent under what circumstances
- a set of rules that determine how client and server agree on a particular protocol and encoding version

Section 34.2 describes the encoding rules, Section 34.3 describes the various protocol messages, Section 34.4 describes compression, and Section 34.5 explains how the protocol and encoding are versioned and how client and server agree on a common version. (Both encoding and protocol specifications are currently at version 1.0.) Finally, Section 34.6 provides a comparison of the Ice protocol and encoding with those used by CORBA.

34.2 Data Encoding

The key goals of the Ice data encoding are simplicity and efficiency. In keeping with these principles, the encoding does not align primitive types on word boundaries and therefore eliminates the wasted space and additional complexity that alignment requires. The Ice data encoding simply produces a stream of contiguous bytes; data contains no padding bytes and need not be aligned on word boundaries.

Data is always encoded using little-endian byte order for numeric types. (Most machines use a little-endian byte order, so the Ice data encoding is “right” more often than not.) Ice does not use a “receiver makes it right” scheme because of the additional complexity this would introduce. Consider, for example, a chain of receivers that merely forward data along the chain until that data arrives at an ultimate receiver. (Such topologies are common for event distribution services.) The Ice protocol permits all the intermediates to forward the data without requiring it to be unmarshaled: the intermediates can forward requests by simply copying blocks of binary data. With a “receiver makes it right” scheme, the intermediates would have to unmarshal and remarshal the data whenever the byte order of the next receiver in the chain differs from the byte order of the sender, which is inefficient.

Ice requires clients and servers that run on big-endian machines to incur the extra cost of byte swapping data into little-endian layout, but that cost is insignificant compared to the overall cost of sending or receiving a request.

34.2.1 Sizes

Many of the types involved in the data encoding, as well as several protocol message components, have an associated size or count. A size is a non-negative number. Sizes and counts are encoded in one of two ways:

1. If the number of elements is less than 255, the size is encoded as a single byte indicating the number of elements.
2. If the number of elements is greater than or equal to 255, the size is encoded as a byte with value 255, followed by an `int` indicating the number of elements.

Using this encoding to indicate sizes is significantly cheaper than always using an `int` to store the size, especially when marshaling sequences of short strings: counts of up to 254 require only a single byte instead of four. This comes at the expense of counts greater than 254, which require five bytes instead of four.

However, for sequences or strings of length greater than 254, the extra byte is insignificant.

34.2.2 Encapsulations

An encapsulation is used to contain variable-length data that an intermediate receiver may not be able to decode, but that the receiver can forward to another recipient for eventual decoding. An encapsulation is encoded as if it were the following structure:

```
struct Encapsulation {
    int size;
    byte major;
    byte minor;
    // [... size - 6 bytes ...]
};
```

The `size` member specifies the size of the encapsulation in bytes (including the `size`, `major`, and `minor` fields). The `major` and `minor` fields specify the encoding version of the data contained in the encapsulation (see Section 34.5.2). The version information is followed by `size-6` bytes of encoded data.

All the data in an encapsulation is context-free, that is, nothing inside an encapsulation can refer to anything outside the encapsulation. This property allows encapsulations to be forwarded among address spaces as a blob of data.

Encapsulations can be nested, that is, contain other encapsulations.

An encapsulation can be empty, in which case its byte count is 6.

34.2.3 Slices

Exceptions and classes are subject to slicing if the receiver of a value only partially understands the received value (that is, only has knowledge of a base type, but not of the actual run-time derived type). To allow the receiver of an exception or class to ignore those parts of a value that it does not understand, exception and class values are marshaled as a sequence of slices (one slice for each level of the inheritance hierarchy). A slice is a byte count encoded as a fixed-length four-byte integer, followed by the data for the slice. (The byte count includes the four bytes occupied by the count itself, so an empty slice has a byte count of four and no data.) The receiver of a value can skip over a slice by reading the byte count b , and then discarding the next $b-4$ bytes in the input stream.

A slice can be empty, in which case its byte count is 4.

34.2.4 Basic Types

The basic types are encoded as shown in Table 34.1. Integer types (`short`, `int`, `long`) are represented as two's complement numbers, and floating point types (`float`, `double`) use the IEEE standard formats [6]. All numeric types use a little-endian byte order.

Table 34.1. Encoding for basic types.

Type	Encoding
<code>bool</code>	A single byte with value 1 for <code>true</code> , 0 for <code>false</code>
<code>byte</code>	An uninterpreted byte
<code>short</code>	Two bytes (LSB, MSB)
<code>int</code>	Four bytes (LSB .. MSB)
<code>long</code>	Eight bytes (LSB .. MSB)
<code>float</code>	Four bytes (23-bit fractional mantissa, 8-bit exponent, sign bit)
<code>double</code>	Eight bytes (52-bit fractional mantissa, 11-bit exponent, sign bit)

34.2.5 Strings

Strings are encoded as a size (see Section 34.2.1), followed by the string contents in UTF8 format [23]. Strings are not NUL-terminated. An empty string is encoded with a size of zero.

34.2.6 Sequences

Sequences are encoded as a size (see Section 34.2.1) representing the number of elements in the sequence, followed by the elements encoded as specified for their type.

34.2.7 Dictionaries

Dictionaries are encoded as a size (see Section 34.2.1) representing the number of key-value pairs in the dictionary, followed by the pairs. Each key-value pair is

encoded as if it were a struct containing the key and value as members, in that order.

34.2.8 Enumerators

Enumerated values are encoded depending on the number of enumerators:

- If the enumeration has 1 - 127 enumerators, the value is marshaled as a byte.
- If the enumeration has 128 - 32767 members, the value is marshaled as a short.
- If the enumeration has more than 32767 members, the value is marshaled as an int.

The value is the ordinal value of the corresponding enumerator, with the first enumerator value encoded as zero.

34.2.9 Structures

The members of a structure are encoded in the order they appear in the struct declaration, as specified for their types.

34.2.10 Exceptions

Exceptions are marshaled as shown in Figure 34.1

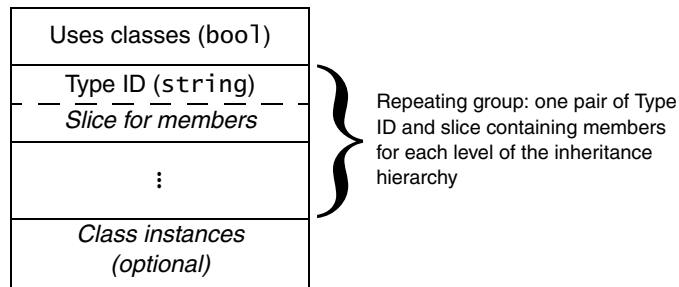

Figure 34.1. Marshaling format for exceptions.

Every exception instance is preceded by a single byte that indicates whether the exception uses class members: the byte value is 1 if any of the exception members

are classes (or if any of the exception members, recursively, contain class members) and 0, otherwise.

Following the header byte, the exception is marshaled as a sequence of pairs: the first member of each pair is the type ID for an exception slice, and the second member of the pair is a slice containing the marshaled members of that slice. The sequence of pairs is marshaled in derived-to-base order, with the most-derived slice first, and ending with the least-derived slice. Within each slice, data members are marshaled as for structures: in the order in which they are defined in the Slice definition.

Following the sequence of pairs, any class instances that are used by the members of the exception are marshaled. This final part is optional: it is present only if the header byte is 1. (See Section 34.2.11 for a detailed explanation of how class instances are marshaled.)

To illustrate the marshaling, consider the following exception hierarchy:

```
exception Base {
    int baseInt;
    string baseString;
};

exception Derived extends Base {
    bool derivedBool;
    string derivedString;
    double derivedDouble;
};
```

Assume that the exception members are initialized to the values shown in Table 34.2.

Table 34.2. Member values of an exception of type `Derived`.

Member	Type	Value	Marshaled Size (in bytes)
<code>baseInt</code>	<code>int</code>	99	4
<code>baseString</code>	<code>string</code>	"Hello"	6
<code>derivedBool</code>	<code>bool</code>	true	1
<code>derivedString</code>	<code>string</code>	"World!"	7
<code>derivedDouble</code>	<code>double</code>	3.14	8

From Table 34.2, we can see that the total size of the members of `Base` is 10 bytes, and the total size of the members of `Derived` is 16 bytes. None of the exception members are classes. An instance of this exception has the on-the-wire representation shown in Table 34.3. (The size, type, and byte offset of the marshaled representation is indicated for each component.)

Table 34.3. Marshaled representation of the exception in Table 34.2.

Marshaled Value	Size in Bytes	Type	Byte offset
0 (<i>no class members</i>)	1	bool	0
"::Derived" (<i>type ID</i>)	10	string	1
20 (<i>byte count for slice</i>)	4	int	11
1 (<i>derivedBool</i>)	1	bool	15
"World!" (<i>derivedString</i>)	7	string	16
3.14 (<i>derivedDouble</i>)	8	double	23
"::Base" (<i>type ID</i>)	7	string	31
14 (<i>byte count for slice</i>)	4	int	38
99 (<i>baseInt</i>)	4	int	42
"Hello" (<i>baseString</i>)	6	string	46

Note that the size of each string is one larger than the actual string length. This is because each string is preceded by a count of its number of bytes, as explained in Section 34.2.5.

The receiver of this sequence of values uses the header byte to decide whether it eventually must unmarshal any class instances contained in the exception (none in this example) and then examines the first type ID (`::Derived`). If the receiver recognizes that type ID, it can unmarshal the contents of the first slice, followed by the remaining slices; otherwise, the receiver reads the byte count that follows the unknown type (20) and then skips 20–4 bytes in the input stream, which is the start of the type ID for the second slice (`::Base`). If the receiver does not recognize that type ID either, it again reads the byte count following the type ID (14), skips 14–4 bytes, and attempts to read another type ID. (This can happen only if client and server have been compiled with mismatched Slice definitions that disagree in the exception specification of an operation.) In this case, the receiver

will eventually encounter an unmarshaling error, which it can report with a `MarshalException`.

If an exception contains class members, these members are marshaled following the exception slices as described in the following section.

34.2.11 Classes

The marshaling for classes is complex, due to the need to deal with the pointer semantics for graphs of classes, as well as the need for the receiver to slice classes of unknown derived type. In addition, the marshaling for classes uses a type ID compression scheme to avoid repeatedly marshaling the same type IDs for large graphs of class instances.

Basic Marshaling Format

Classes are marshaled similar to exceptions: each instance is divided into a number of pairs containing a type ID and a slice (one pair for each level of the inheritance hierarchy) and marshaled in derived-to-base order. Only data members are marshaled—no information is sent that would relate to operations. Unlike exceptions, no header byte precedes a class. Instead, each marshaled class instance is preceded by a (non-zero) positive integer that provides an identity for the instance. The sender assigns this identity during marshaling such that each marshaled instance has a different identity. The receiver uses that identity to correctly reconstruct graphs of classes. The overall marshaling format for classes is shown in Figure 34.2.

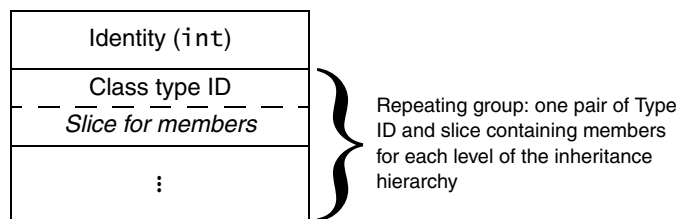

Figure 34.2. Marshaling format for classes.

Class Type IDs

Unlike for exception type IDs, class type IDs are not simple strings. Instead, a class type ID is marshaled as a boolean followed by either a string or a size, to conserve bandwidth. To illustrate this, consider the following class hierarchy:

```
class Base {
    // ...
};

class Derived extends Base {
    // ...
};
```

The type IDs for the class slices are `::Derived` and `::Base`. Suppose the sender marshals three instances of `::Derived` as part of a single request. (For example, two instances could be out-parameters and one instance could be the return value.)

The first instance that is sent on the wire contains the type IDs `::Derived` and `::Base` preceding their respective slices. Because marshaling proceeds in derived-to-base order, the first type ID that is sent is `::Derived`. Every time the sender sends a type ID that it has not sent previously in the same request, it sends the boolean value `false`, followed by the type ID. Internally, the sender also assigns a unique positive number to each type ID. These numbers start at 1 and increment by one for each type ID that has not been marshaled previously. This means that the first type ID is encoded as the boolean value `false`, followed by `::Derived`, and the second type ID is encoded as the boolean value `false`, followed by `::Base`.

When the sender marshals the remaining two instances, it consults a lookup table of previously-marshaled type IDs. Because both type IDs were sent previously in the same request (or reply), the sender encodes all further occurrences of `::Derived` as the value `true` followed by the number 1 encoded as a size (see Section 34.2.1), and it encodes all further occurrences of `::Base` as the value `true` followed by the number 2 encoded as a size.

When the receiver reads a type ID, it first reads its boolean marker:

- If the boolean is `false`, the receiver reads a string and enters that string into a lookup table that maps integers to strings. The first new class type ID received in a request is numbered 1, the second new class type ID is numbered 2, and so on.

- If the boolean value is `true`, the receiver reads a number encoded as a size and uses that number to index into the lookup table to retrieve the corresponding class type ID.

Note that this numbering scheme is re-established for each new encapsulation. (As we will see in Section 34.3, parameters, return values, and exceptions are always marshaled inside an enclosing encapsulation.) For subsequent or nested encapsulation, the numbering scheme restarts, with the first new type ID being assigned the value 1. In other words, each encapsulation uses its own independent numbering scheme for class type IDs to satisfy the constraint that encapsulations must not depend on their surrounding context.

Encoding class type IDs in this way provides significant savings in bandwidth: whenever an ID is marshaled a second and subsequent time, it is marshaled as a two-byte value (assuming no more than 254 distinct type IDs per request) instead of as a string. Because type IDs can be long, especially if you are using nested modules, the savings are considerable.

Simple Class Marshaling Example

To make the preceding discussion more concrete, consider the following class definitions:

```
interface SomeInterface {
    void op1();
};

class Base {
    int baseInt;
    void op2();
    string baseString;
};

class Derived extends Base implements SomeInterface {
    bool derivedBool;
    string derivedString;
    void op3();
    double derivedDouble;
};
```

Note that `Base` and `Derived` have operations, and that `Derived` also implements the interface `SomeInterface`. Because marshaling of classes is concerned with state, not behavior, the operations `op1`, `op2`, and `op3` are simply ignored during

marshaling and the on-the-wire representation is as if the classes had been defined as follows:

```
class Base {
    int baseInt;
    string baseString;
};

class Derived extends Base {
    bool derivedBool;
    string derivedString;
    double derivedDouble;
};
```

Suppose the sender marshals two instances of `Derived` (for example, as two in-parameters in the same request). The member values are as shown in Table 34.4.

Table 34.4. Member values for two instances of class `Derived`.

	Member	Type	Value	Marshaled Size (in bytes)
First instance	<code>baseInt</code>	<code>int</code>	99	4
	<code>baseString</code>	<code>string</code>	"Hello"	6
	<code>derivedBool</code>	<code>bool</code>	true	1
	<code>derivedString</code>	<code>string</code>	"World!"	7
	<code>derivedDouble</code>	<code>double</code>	3.14	8
Second instance	<code>baseInt</code>	<code>int</code>	115	4
	<code>baseString</code>	<code>string</code>	"Cave"	5
	<code>derivedBool</code>	<code>bool</code>	false	1
	<code>derivedString</code>	<code>string</code>	"Canem"	6
	<code>derivedDouble</code>	<code>double</code>	6.32	8

The sender arbitrarily assigns a non-zero identity (see page 964) to each instance. Typically, the sender will simply consecutively number the instances starting at 1. For this example, assume that the two instances have the identities 1 and 2. The

marshaled representation for the two instances (assuming that they are marshaled immediately following each other) is shown in Table 34.5.

Table 34.5. Marshaled representation of the two instances in Table 34.4.

Marshaled Value	Size in Bytes	Type	Byte offset
1 (<i>identity</i>)	4	int	0
0 (<i>marker for class type ID</i>)	1	bool	4
"::Derived" (<i>class type ID</i>)	10	string	5
20 (<i>byte count for slice</i>)	4	int	15
1 (<i>derivedBool</i>)	1	bool	19
"World!" (<i>derivedString</i>)	7	string	20
3.14 (<i>derivedDouble</i>)	8	double	27
0 (<i>marker for class type ID</i>)	1	bool	35
"::Base" (<i>type ID</i>)	7	string	36
14 (<i>byte count for slice</i>)	4	int	43
99 (<i>baseInt</i>)	4	int	47
"Hello" (<i>baseString</i>)	6	string	51
0 (<i>marker for class type ID</i>)	1	bool	57
"::Ice::Object" (<i>class type ID</i>)	14	string	58
5 (<i>byte count for slice</i>)	4	int	72
0 (<i>number of dictionary entries</i>)	1	size	76
2 (<i>identity</i>)	4	int	77
1 (<i>marker for class type ID</i>)	1	bool	81
1 (<i>class type ID</i>)	1	size	82
19 (<i>byte count for slice</i>)	4	int	83
0 (<i>derivedBool</i>)	1	bool	87
"Canem" (<i>derivedString</i>)	6	string	88

Table 34.5. Marshaled representation of the two instances in Table 34.4.

Marshaled Value	Size in Bytes	Type	Byte offset
6.32 (<i>derivedDouble</i>)	8	double	94
1 (<i>marker for class type ID</i>)	1	bool	102
9 (<i>byte count for slice</i>)	4	int	103
2 (<i>class type ID</i>)	1	size	107
115 (<i>baseInt</i>)	4	int	108
"Cave" (<i>baseString</i>)	5	string	112
1 (<i>marker for class type ID</i>)	1	bool	117
3 (<i>class type ID</i>)	1	size	118
5 (<i>byte count for slice</i>)	4	int	119
0 (<i>number of dictionary entries</i>)	1	size	123

Note that, because classes (like exceptions) are sent as a sequence of slices, the receiver of a class can slice off any derived parts of a class it does not understand. Also note that (as shown in Table 34.5) each class instance contains three slices. The third slice is for the type `::Ice::Object`, which is the base type of all classes. The class type ID `::Ice::Object` has the number 3 in this example because it is the third distinct type ID that is marshaled by the sender. (See entries at byte offsets 58 and 118 in Table 34.5.) All class instances have this final slice of type `::Ice::Object`.

Marshaling a separate slice for `::Ice::Object` dates back to Ice versions 1.3 and earlier. In those versions, classes carried a facet map that was marshaled as if it were defined as follows:

```

module Ice {
    class Object;

    dictionary<string, Object> FacetMap;

    class Object {
        FacetMap facets; // No longer exists
    };
};

```

As of Ice version 1.4, this facet map is always empty, that is, the count of entries for the dictionary that is marshaled in the `::Ice::Object` slice is always zero. If a receiver receives a class instance with a non-empty facet map, it must throw a `MarshalException`.

Note that if a class has no data members, a type ID and slice for that class is still marshaled. The byte count of the slice will be 4 in this case, indicating that the slice contains no data.

Marshaling Pointers

Classes support pointer semantics, that is, you can construct graphs of classes. It follows that classes can arbitrarily point at each other. The class identity (see page 964) is used to distinguish instances and pointers as follows:

- A class identity of 0 denotes a null pointer.
- A class identity > 0 precedes the marshaled contents of an instance (see page 964).
- A class identity < 0 denotes a pointer to an instance.

Identity values less than zero are pointers. For example, if the receiver receives the identity -57 , this means that the corresponding class member that is currently being unmarshaled will eventually point at the instance with identity 57.

For structures, classes, exceptions, sequences, and dictionary members that do not contain class members, the Ice protocol uses a simple depth-first traversal algorithm to marshal the members. For example, structure members are marshaled in the order of their Slice definition; if a structure member itself is of complex type, such as a sequence, the sequence is marshaled in toto where it appears inside its enclosing structure. For complex types that contain class members, this depth-first marshaling is suspended: instead of marshaling the actual class instance at this point, a negative identity is marshaled that indicates which class instance that member must eventually denote. For example, consider the following definitions:

```
class C {
    // ...
};

struct S {
    int i;
    C firstC;
    C secondC;
    C thirdC;
    int j;
};
```

Suppose we initialize a structure of type `S` as follows:

```
S myS;
myS.i = 99;
myS.firstC = new C;           // New instance
myS.secondC = 0;             // null
myS.thirdC = myS.firstC;     // Same instance as previously
myS.j = 100;
```

When this structure is marshaled, the contents of the three class members are not marshaled in-line. Instead, the sender marshals the negative identities of the corresponding instances. Assuming that the sender has assigned the identity 78 to the instance assigned to `myS.firstC`, `myS` is marshaled as shown in Table 34.6.

Table 34.6. Marshaled representation of `myS`.

Marshaled Value	Size in Bytes	Type	Byte offset
99 (<i>myS.i</i>)	4	int	0
-78 (<i>myS.firstC</i>)	4	int	4
0 (<i>myS.secondC</i>)	4	int	8
-78 (<i>mys.thirdC</i>)	4	int	12
100 (<i>myS.j</i>)	4	int	16

Note that `myS.firstC` and `myS.thirdC` both use the identity `-78`. This allows the receiver to recognize that `firstC` and `thirdC` point at the same class instance (rather than at two different instances that happen to have the same contents).

Marshaling the negative identities instead of the contents of an instance allows the receiver to accurately reconstruct the class graph that was sent by the sender. However, this begs the question of *when* the actual instances are to be marshaled as described at the beginning of this section. As we will see in Section 34.3, parameters and return values are marshaled as if they were members of a structure. For example, if an operation invocation has five input parameters, the client marshals the five parameters end-to-end as if they were members of a single structure. If any of the five parameters are class instances, or are of complex type (recursively) containing class instances, the sender marshals the parameters in multiple passes: the first pass marshals the parameters end-to-end, using the usual depth-first algorithm:

- If the sender encounters a class member during marshaling, it checks whether it has marshaled the same instance previously for the current request or reply:
 - If the instance has not been marshaled before, the sender assigns a new identity to the instance and marshals the negative identity.
 - Otherwise, if the instance was marshaled previously, the sender sends the same negative identity that is previously sent for that instance.

In effect, during marshaling, the sender builds an identity table that is indexed by the address of each instance; the lookup value for the instance is its identity.

Once the first pass ends, the sender has marshaled all the parameters, but has not yet marshaled any of the class instances that may be pointed at by various parameters or members. The identity table at this point contains all those instances for which negative identities (pointers) were marshaled, so whatever is in the identity table at this point are the classes that the receiver still needs. The sender now marshals those instances in the identity table, but with positive identities and followed by their contents, as described on page 966. The outstanding instances are marshaled as a sequence, that is, the sender marshals the number of instances as a size (see Section 34.2.1), followed by the actual instances.

In turn, the instances just sent may themselves contain class members; when those class members are marshaled, the sender assigns an identity to new instances or uses a negative identity for previously marshaled instances as usual. This means that, by the end of the second pass, the identity table may have grown, necessitating a third pass. That third pass again marshals the outstanding class instances as a size followed by the actual instances. The third pass contains all those instances that were not marshaled in the second pass. Of course, the third pass may trigger yet more passes until, finally, the sender has sent all outstanding instances, that is, marshaling is complete. At this point, the sender terminates the sequence of passes by marshaling an empty sequence (the value 0 encoded as a size).

To illustrate this with an example, consider the definitions shown in Section 4.11.7 on page 132 once more:

```
enum UnaryOp { UnaryPlus, UnaryMinus, Not };
enum BinaryOp { Plus, Minus, Multiply, Divide, And, Or };

class Node {
    idempotent long eval();
};
```

```

class UnaryOperator extends Node {
    UnaryOp operator;
    Node operand;
};

class BinaryOperator extends Node {
    BinaryOp op;
    Node operand1;
    Node operand2;
};

class Operand {
    long val;
};

```

These definitions allow us to construct expression trees. Suppose the client initializes a tree to the shape shown in Figure 34.3, representing the expression $(1 + 6 / 2) * (9 - 3)$. The values outside the nodes are the identities assigned by the client.

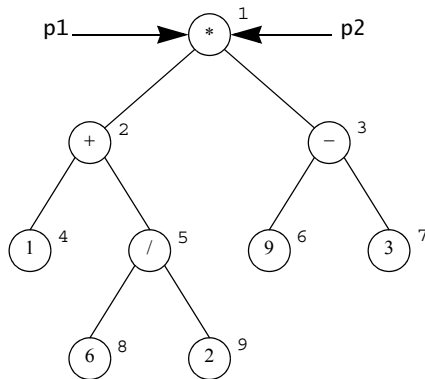

Figure 34.3. Expression tree for the expression $(1 + 6 / 2) * (9 - 3)$. Both p1 and p2 denote the root node.

The client passes the root of the tree to the following operation in the parameters p1 and p2, as shown on page 973. (Even though it does not make sense to pass the same parameter value twice, we do it here for illustration purposes):

```

interface Tree {
    void sendTree(Node p1, Node p2);
};

```

The client now marshals the two parameters p1 and p2 to the server, resulting in the value -1 being sent twice in succession. (The client arbitrarily assigns an identity to each node. The value of the identity does not matter, as long as each node has a unique identity. For simplicity, the Ice implementation numbers instances with a counter that starts counting at 1 and increments by one for each unique instance.) This completes the marshaling of the parameters and results in a single instance with identity 1 in the identity table. The client now marshals a sequence containing a single element, node 1, as described on page 966. In turn, node 1 results in nodes 2 and 3 being added to the identity table, so the next sequence of nodes contains two elements, nodes 2 and 3. The next sequence of nodes contains nodes 4, 5, 6, and 7, followed by another sequence containing nodes 8 and 9. At this point, no more class instances are outstanding, and the client marshals an empty sequence to indicate to the receiver that the final sequence has been marshaled.

Within each sequence, the order in which class instances are marshaled is irrelevant. For example, the third sequence could equally contain nodes 7, 6, 4, and 5, in that order. What is important here is that each sequence contains nodes that are an equal number of “hops” away from the initial node: the first sequence contains the initial node(s), the second sequence contains all nodes that can be reached by traversing a single link from the initial node(s), the third sequence contains all nodes that can be reached by traversing two links from the initial node(s), and so on.

Now consider the same example once more, but with different parameter values for sendTree: p1 denotes the root of the tree, and p2 denotes the $-$ operator of the right-hand sub-tree, as shown in Figure 34.4.

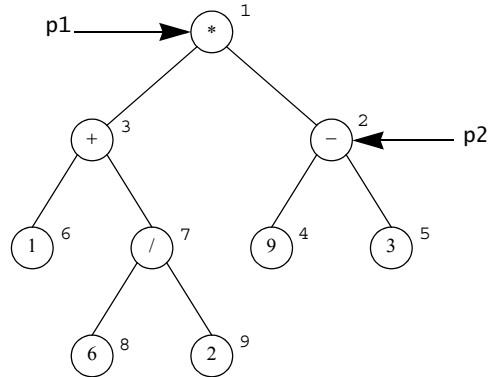

Figure 34.4. The expression tree of Figure 34.3, with p1 and p2 denoting different nodes.

The graph that is marshaled is exactly the same, but instances are marshaled in a different order and with different identities:

- During the first pass, the client sends the identities -1 and -2 for the parameter values.
- The second pass marshals a sequence containing nodes 1 and 2.
- The third pass marshals a sequence containing nodes 3, 4, and 5.
- The fourth pass marshals a sequence containing nodes 6 and 7.
- The fifth pass marshals a sequence containing nodes 8 and 9.
- The final pass marshals an empty sequence.

In this way, any graph of nodes can be transmitted (including graphs that contain cycles). The receiver reconstructs the graph by filling in a patch table during unmarshaling:

- Whenever the receiver unmarshals a negative identity, it adds that identity to a patch table; the lookup value is the memory address of the parameter or member that eventually will point at the corresponding instance.
- Whenever the receiver unmarshals an actual instance, it adds the instance to an unmarshaled table; the lookup value is the memory address of the instantiated class. The receiver then uses the address of the instance to patch any parameters or members with the actual memory address.

Note that the receiver may receive negative identities that denote class instances that have been unmarshaled already (that is, point “backward” in the unmarshaling stream), as well as instances that are yet to be unmarshaled (that is, point “forward” in the unmarshaling stream). Both scenarios are possible, depending on the order in which instances are marshaled, as well as their in-degree.

To provide another example, consider the following definition:

```
class C {  
    // ...  
};  
  
sequence<C> CSeq;
```

Suppose the client marshals a sequence of 100 C instances to the server, with each instance being distinct. (That is, the sequence contains 100 pointers to 100 different instances, not 100 pointers to the same single instance.) In that case, the sequence is marshaled as a size of 100, followed by 100 negative identities, -1 to -100. Following that, the client marshals a single sequence containing the 100 instances, each instance with its positive identity in the range 1 to 100, and completes by marshaling an empty sequence.

On the other hand, if the client sends a sequence of 100 elements that all point to the same single class instance, the client marshals the sequence as a size of 100, followed by 100 negative identities, all with the value -1. The client then marshals a sequence containing a single element, namely instance 1, and completes by marshaling an empty sequence.

Class Graphs and Slicing

It is important to note that when a graph of class instances is sent, it always forms a connected graph. However, when the receiver rebuilds the graph, it may end up with a disconnected graph, due to slicing. Consider:

```
class Base {  
    // ...  
};  
  
class Derived extends Base {  
    // ...  
    Base b;  
};
```

```
interface Example {
    void op(Base p);
};
```

Suppose the client has complete type knowledge, that is, understands both types `Base` and `Derived`, but the server only understands type `Base`, so the derived part of a `Derived` instance is sliced. The client can instantiate classes to be sent as parameter `p` as follows:

```
DerivedPtr p = new Derived;
p->b = new Derived;
ExamplePrx e = ...;
e->op(p);
```

As far as the client is concerned, the graph looks like the one shown in Figure 34.5.

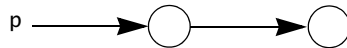

Figure 34.5. Sender-side view of a graph containing derived instances.

However, the server does not understand the derived part of the instances and slices them. Yet, the server unmarshals all the class instances, leading to the situation where the class graph has become disconnected, as shown in Figure 34.6.



Figure 34.6. Receiver-side view of the graph in Figure 34.5.

Of course, more complex situations are possible, such that the receiver ends up with multiple disconnected graphs, each containing many instances.

Exceptions with Class Members

If an exception contains class members, its header byte (see page 961) is 1 and the exception members are followed by the outstanding class instances as described on the preceding pages, that is, the actual exception members are followed by one or more sequences that contain the outstanding class instances, followed by an empty sequence that serves as an end marker.

34.2.12 Proxies

The first component of an encoded proxy is a value of type `Ice::Identity`. If the proxy is a nil value, the category and name members are empty strings, and no additional data is encoded. The encoding for a non-null proxy consists of general parameters followed by endpoint parameters.

General Proxy Parameters

The general proxy parameters are encoded as if they were members of the following structure:

```
struct ProxyData {
    Ice::Identity id;
    Ice::StringSeq facet;
    byte mode;
    bool secure;
};
```

The general proxy parameters are described in Table 34.7.

Table 34.7. General proxy parameters.

Parameter	Description
<code>id</code>	The object identity
<code>facet</code>	The facet name (zero- or one-element sequence)
<code>mode</code>	The proxy mode (0=twoway, 1=oneway, 2=batch oneway, 3=datagram, 4=batch datagram)
<code>secure</code>	true if secure endpoints are required, otherwise false

The facet field has either zero elements or one element. An empty sequence denotes the default facet, and a one-element sequence provides the facet name in its first member. If a receiver receives a proxy with a facet field with more than one element, it must throw a `ProxyUnmarshalException`.

Endpoint Parameters

A proxy optionally contains an endpoint list (see Appendix D) or an adapter identifier, but not both.

- If a proxy contains endpoints, they are encoded immediately following the general parameters. A size specifying the number of endpoints is encoded first (see Section 34.2.1), followed by the endpoints. Each endpoint is encoded as a `short` specifying the endpoint type (1=TCP, 2=SSL, 3=UDP), followed by an encapsulation (see Section 34.2.2) of type-specific parameters. The type-specific parameters for TCP, UDP, and SSL are presented in the sections that follow.
- If a proxy does not have endpoints, a single byte with value 0 immediately follows the general parameters and a string representing the object adapter identifier is encoded immediately following the zero byte.

Type-specific endpoint parameters are encapsulated because a receiver may not be capable of decoding them. For example, a receiver can only decode SSL endpoint parameters if it is configured with the SSL plug-in (see Chapter 40). However, the receiver must be able to re-encode the proxy with all of its original endpoints, in the order they were received, even if the receiver does not understand the type-specific parameters for an endpoint. Encapsulation of the parameters allows the receiver to do this.

TCP Endpoint Parameters

A TCP endpoint is encoded as an encapsulation containing the following structure:

```
struct TCPEndpointData {
    string host;
    int port;
    int timeout;
    bool compress;
};
```

The endpoint parameters are described in Table 34.8.

Table 34.8. TCP endpoint parameters.

Parameter	Description
host	The server host (a host name or IP address)
port	The server port (1-65535)
timeout	The timeout in milliseconds for socket operations
compress	true if compression should be used (if possible), otherwise false

See Section 34.4 for more information on compression.

UDP Endpoint Parameters

A UDP endpoint is encoded as an encapsulation containing the following structure:

```
struct UDPEndpointData {
    string host;
    int port;
    byte protocolMajor;
    byte protocolMinor;
    byte encodingMajor;
    byte encodingMinor;
    bool compress;
};
```

The endpoint parameters are described in Table 34.9.

Table 34.9. UDP endpoint parameters.

Parameter	Description
host	The server host (a host name or IP address)
port	The server port (1-65535)
protocolMajor	The major protocol version supported by the endpoint
protocolMinor	The highest minor protocol version supported by the endpoint
encodingMajor	The major encoding version supported by the endpoint
encodingMinor	The highest minor encoding version supported by the endpoint
compress	true if compression should be used (if possible), otherwise false

See Section 34.4 for more information on compression.

SSL Endpoint Parameters

An SSL endpoint is encoded as an encapsulation containing the following structure:

```
struct SSLEndpointData {
    string host;
    int port;
    int timeout;
    bool compress;
};
```

The endpoint parameters are described in Table 34.10.

Table 34.10. SSL endpoint parameters.

Parameter	Description
host	The server host (a host name or IP address)
port	The server port (1-65535)
timeout	The timeout in milliseconds for socket operations
compress	true if compression should be used (if possible), otherwise false

See Section 34.4 for more information on compression.

34.3 Protocol Messages

The Ice protocol uses five protocol messages:

- Request (from client to server)
- Batch request (from client to server)
- Reply (from server to client)
- Validate connection (from server to client)
- Close connection (client to server or server to client)

Of these messages, validate and close connection only apply to connection-oriented transports.

As with the data encoding described in Section 34.2, protocol messages have no alignment restrictions. Each message consists of a message header and (except for validate and close connection) a message body that immediately follows the header.

34.3.1 Message Header

Each protocol message has a 14-byte header that is encoded as if it were the following structure:

```

struct HeaderData {
    int  magic;
    byte protocolMajor;
    byte protocolMinor;
    byte encodingMajor;
    byte encodingMinor;
    byte messageType;
    byte compressionStatus;
    int  messageSize;
};

```

The members are described in Table 34.11.

Table 34.11. Message header members.

Member	Description
magic	A four-byte magic number consisting of the ASCII-encoded values of 'I', 'c', 'e', 'P' (0x49, 0x63, 0x65, 0x50)
protocolMajor	The protocol major version number
protocolMinor	The protocol minor version number
encodingMajor	The encoding major version number
encodingMinor	The encoding minor version number
messageType	The message type
compressionStatus	The compression status of the message (see Section 34.4)
messageSize	The size of the message in bytes, including the header

Currently, both the protocol and the encoding are at version 1.0. The valid message types are shown in Table 34.12.

Table 34.12. Message types.

Message Type	Encoding
Request	0
Batch request	1
Reply	2
Validate connection	3
Close connection	4

The encoding for these message bodies of each of these message types is described in the sections that follow.

34.3.2 Request Message Body

A request message contains the data necessary to perform an invocation on an object, including the identity of the object, the operation name, and input parameters. A request message is encoded as if it were the following structure:

```
struct RequestData {
    int requestId;
    Ice::Identity id;
    Ice::StringSeq facet;
    string operation;
    byte mode;
    Ice::Context context;
    Encapsulation params;
};
```

The members are described in Table 34.13.

Table 34.13. Request members.

Member	Description
requestId	The request identifier
id	The object identity
facet	The facet name (zero- or one-element sequence)
operation	The operation name
mode	A byte representation of <code>Ice::OperationMode</code> (0=normal, 1=nonmutating, 2=idempotent)
context	The invocation context
params	The encapsulated input parameters, in order of declaration

The request identifier zero (0) is reserved for use in oneway requests and indicates that the server must not send a reply to the client. A non-zero request identifier must uniquely identify the request on a connection, and must not be reused while a reply for the identifier is outstanding.

The facet field has either zero elements or one element. An empty sequence denotes the default facet, and a one-element sequence provides the facet name in its first member. If a receiver receives a request with a facet field with more than one element, it must throw a `MarshalException`.

34.3.3 Batch Request Message Body

A batch request message contains one or more oneway requests, bundled together for the sake of efficiency. A batch request message is encoded as integer (not a size) that specifies the number of requests in the batch, followed by the corresponding number of requests, encoded as if each request were the following structure:

```
struct BatchRequestData {
    Ice::Identity id;
    Ice::StringSeq facet;
    string operation;
```

```

    byte mode;
    Ice::Context context;
    Encapsulation params;
};

```

The members are described in Table 34.14.

Table 34.14. Batch request members.

Member	Description
id	The object identity
facet	The facet name (zero- or one-element sequence)
operation	The operation name
mode	A byte representation of <code>Ice::OperationMode</code>
context	The invocation context
params	The encapsulated input parameters, in order of declaration

Note that no request ID is necessary for batch requests because only oneway invocations can be batched.

The facet field has either zero elements or one element. An empty sequence denotes the default facet, and a one-element sequence provides the facet name in its first member. If a receiver receives a batch request with a facet field with more than one element, it must throw a `MarshalException`.

34.3.4 Reply Message Body

A reply message body contains the results of a twoway invocation, including any return value, out-parameters, or exception. A reply message body is encoded as if it were the following structure:

```

struct ReplyData {
    int requestId;
    byte replyStatus;
    Encapsulation body; // messageSize - 19 bytes
};

```

The first four bytes of a reply message body contain a request ID. The request ID matches an outgoing request and allows the requester to associate the reply with the original request (see Section 34.3.2).

The byte following the request ID indicates the status of the request; the remainder of the reply message body following the status byte is an encapsulation whose contents depend on the status value. The possible status values are shown in Table 34.15.

Table 34.15. Reply status.

Reply status	Encoding
Success	0
User exception	1
Object does not exist	2
Facet does not exist	3
Operation does not exist	4
Unknown Ice local exception	5
Unknown Ice user exception	6
Unknown exception	7

Reply Status 0: Success

A successful reply message is encoded as an encapsulation containing out-parameters (in the order of declaration), followed by the return value for the invocation, encoded according to their types as specified in Section 34.2. If an operation declares a void return type and no out-parameters, an empty encapsulation is encoded.

Reply Status 1: User exception

A user exception reply message contains an encapsulation containing the user exception, encoded as described in Section 34.2.10.

Reply Status 2: Object does not exist

If the target object does not exist, the reply message is encoded as if it were the following structure inside an encapsulation:

```

struct ReplyData {
    Ice::Identity id;
    Ice::StringSeq facet;
    string operation;
};

```

The members are described in Table 34.16.

Table 34.16. Invalid object reply members.

Member	Description
id	The object identity
facet	The facet name (zero- or one-element sequence)
operation	The operation name

The facet field has either zero elements or one element. An empty sequence denotes the default facet, and a one-element sequence provides the facet name in its first member. If a receiver receives a reply with a facet field with more than one element, it must throw a `MarshalException`.

Reply Status 3: Facet does not exist

If the target object does not support the facet encoded in the request message, the reply message is encoded as for reply status 2.

Reply Status 4: Operation does not exist

If the target object does not support the operation encoded in the request message, the reply message is encoded as for reply status 2.

Reply Status 5: Unknown Ice local exception

The reply message for an unknown Ice local exception is encoded as an encapsulation containing a single string that describes the exception.

Reply Status 6: Unknown Ice user exception

The reply message for an unknown Ice user exception is encoded as an encapsulation containing a single string that describes the exception.

Reply Status 7: Unknown exception

The reply message for an unknown exception is encoded as an encapsulation containing a single string that describes the exception.

34.3.5 Validate Connection Message

A server sends a validate connection message when it receives a new connection.¹ The message indicates that the server is ready to receive requests; the client must not send any messages on the connection until it has received the validate connection message from the server. No reply to the message is expected by the server.

The purpose of the validate connection message is two-fold:

- It informs the client of the protocol and encoding versions that are supported by the server (see Section 34.5.3).
- It prevents the client from writing a request message to its local transport buffers until after the server has acknowledged that it can actually process the request. This avoids a race condition caused by the server's TCP/IP stack accepting connections in its backlog while the server is in the process of shutting down: if the client were to send a request in this situation, the request would be lost but the client could not safely re-issue the request because that might violate at-most-once semantics.

The validate connection message guarantees that a server is not in the middle of shutting down when the server's TCP/IP stack accepts an incoming connection and so avoids the race condition.

The message header described in Section 34.3.1 on page 982 comprises the entire validate connection message. The compression status of a validate connection message is always 0.

34.3.6 Close Connection Message

A close connection message is sent when a peer is about to gracefully shutdown a connection.² The message header described in Section 34.3.1 comprises the entire close connection message. The compression status of a close connection message is always 0.

1. Validate connection messages are only used for connection-oriented transports.

2. Close connection messages are only used for connection-oriented transports.

Either client or server can initiate connection closure. On the client side, connection closure is triggered by *Active Connection Management (ACM)* (see Section 35.4), which automatically reclaims connections that have been idle for some time.

This means that connection closure can be initiated at will by either end of a connection; most importantly, no state is associated with a connection as far as the object model or application semantics are concerned.

The client side can close a connection whenever no reply for a request is outstanding on the connection. The sequence of events is:

1. The client sends a close connection message.
2. The client closes the writing end of the connection.
3. The server responds to the client's close connection message by closing the connection.

The server side can close a connection whenever no operation invocation is in progress that was invoked via that connection. This guarantees that the server will not violate at-most-once semantics: an operation, once invoked in a servant, is allowed to complete and its results are returned to the client. Note that the server can close a connection even after it has received a request from the client, provided that the request has not yet been passed to a servant. In other words, if the server decides that it wants to close a connection, the sequence of events is:

1. The server discards all incoming requests on the connection.
2. The server waits until all still executing requests have completed and their results have been returned to the client.
3. The server sends a close connection message to the client.
4. The server closes its writing end of the connection.
5. The client responds to the server's close connection message by closing both its reading and writing ends of the connection.
6. If the client has outstanding requests at the time it receives the close connection message, it re-issues these requests on a new connection. Doing so is guaranteed not to violate at-most-once semantics because the server guarantees not to close a connection while requests are still in progress on the server side.

34.3.7 Protocol State Machine

From a client's perspective, the Ice protocol behaves according to the state machine shown in Figure 34.7.

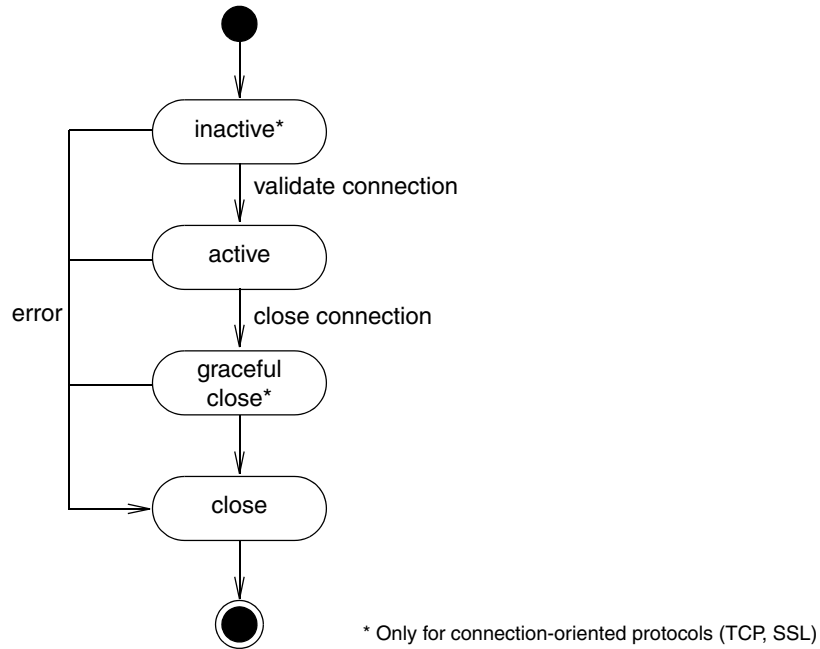

Figure 34.7. Protocol state machine.

To summarize, a new connection is inactive until a validate connection message (see Section 34.3.5) has been received by the client, at which point the active state is entered. The connection remains in the active state until it is shut down, which can occur when there are no more proxies using the connection, or after the connection has been idle for a while. At this point, the connection is gracefully closed, meaning that a close connection message is sent (see Section 34.3.6), and the connection is closed.

34.3.8 Disorderly Connection Closure

Any violation of the protocol or encoding rules results in a disorderly connection closure: the side of the connection that detects a violation unceremoniously closes it (without sending a close connection message or similar). There are many poten-

tial error conditions that can lead to disorderly connection closure; for example, the receiver might detect that a message has a bad magic number or incompatible version, receive a reply with an ID that does not match that of an outstanding request, receive a validate connection message when it should not, or find illegal data in a request (such as a negative size, or a size that disagrees with the actual data that was unmarshaled).

34.4 Compression

Compression is an optional feature of the Ice protocol; whether it is used for a particular message is determined by several factors:

1. Compression may not be supported on all platforms or in all language mappings.
2. Compression can be used in a request or batch request only if the endpoint advertises the ability to accept compressed messages (see Section 34.2.12).
3. For efficiency reasons, the Ice protocol engine does not compress messages smaller than 100 bytes.³

If compression is used, the entire message excluding the header is compressed using the bzip2 algorithm [16]. The `messageSize` member of the message header therefore reflects the size of the compressed message, including the uncompressed header, plus an additional four bytes (see page 993).

3. A compliant implementation of the protocol is free to compress messages that are smaller than 100 bytes—the choice is up to the protocol implementation.

The `compressionStatus` field of the message header (see Section 34.3.1) indicates whether a message is compressed and whether the sender can accept a compressed reply, as shown in Table 34.17.

Table 34.17. Compression status values.

Reply status	Encoding	Applies to
Message is uncompressed, sender cannot accept a compressed reply.	0	Request, Batch Request, Reply, Validate Connection, Close Connection
Message is uncompressed, sender can accept a compressed reply.	1	Request, Batch Request
Message is compressed and sender can accept a compressed reply	2	Request, Batch Request, Reply

- A compression status of 0 indicates that the message is not compressed and, moreover, that the sender of this message cannot accept a compressed reply. A client that does not support compression always uses this value. A client that supports compression sets the value to 0 if the endpoint via which the request is dispatched indicates that it does not support compression.

A server uses this value for uncompressed replies.

- A compression status of 1 indicates that the message is not compressed, but that the server should return a compressed reply (if any). A client uses this value if the endpoint via which the request is dispatched indicates that it supports compression, but the client has decided not to use compression for this particular request (presumably because the request is too small, so compression does not provide any saving).

This value applies only to request and batch request messages.

- A compression status of 2 indicates that the message is compressed and that the server is free to reply with a compressed message (but need not reply with a compressed message). A client that supports compression (obviously) sets this value only if the endpoint via which the request is dispatched indicates that it supports compression.

A server uses this value for compressed replies.

The message body of compressed request, batch request, or reply message is encoded by first writing the size of the uncompressed message (including its

header) as four-byte integer, followed by the compressed message body (excluding the header). It follows that the size of a compressed message is 14 bytes for the header, plus four bytes to record the size of the uncompressed message, plus the number of bytes occupied by the compressed message body (encoded as specified in Sections 34.3.2 through 34.3.4). Writing the uncompressed message size prior to the body enables the receiver to allocate a buffer that is large enough to accommodate the uncompressed message body.

Note that compression is likely to improve performance only over lower-speed links, for which bandwidth is the overall limiting factor. Over high-speed LAN links, the CPU time spent on compressing and uncompressing messages is longer than the time it takes to just send the uncompressed data.

34.5 Protocol and Encoding Versions

As we saw in the preceding sections, both the Ice protocol and encoding have separate major and minor version numbers. Separate versioning of protocol and encoding has the advantage that neither depends on the other: any version of the Ice protocol can be used with any version of the encoding, so they can evolve independently. (For example, Ice protocol version 1.1 could use encoding version 2.3, and vice versa.)

The Ice versioning mechanism provides the maximum possible amount of interoperability between clients and servers that use different versions of the Ice run time. In particular, older deployed clients can communicate with newer deployed servers and vice versa, provided that the message contents use types that are understandable to both sides.

For an example, assume that a later version of Ice were to introduce a new Slice keyword and data type, such as `complex`, for complex numbers. This would require a new minor version number for the encoding; let us assume that version 1.1 of the encoding is identical to the 1.0 encoding but, in addition,

supports the `complex` type. We now have four possible combinations of client and server encoding versions:

Table 34.18. Interoperability for different versions.

Client Version	Server Version	Operation with <code>complex</code> Parameter	Operation without <code>complex</code> Parameter
1.0	1.0	N/A	✓
1.1	1.0	N/A	✓
1.0	1.1	N/A	✓
1.1	1.1	✓	✓

As you can see, interoperability is provided to the maximum extent possible. If both client and server are at version 1.1, they can obviously exchange messages and will use encoding version 1.1. For version 1.0 clients and servers, obviously only operations that do not involve `complex` parameters can be invoked (because at least one of client and server do not know about the new `complex` type) and messages are exchanged using encoding version 1.0.

34.5.1 Version Ground Rules

For versioning of the protocol and encoding to be possible, *all* versions (present and future) of the Ice run time adhere to a few ground rules:

1. Encapsulations always have a six-byte header; the first four bytes are the size of the encapsulation (including the size of the header), followed by two bytes that indicate the major and minor version. How to interpret the remainder of the encapsulation depends on the major and minor version.
2. The first eight bytes of a message header always contain the magic number ‘I’, ‘c’, ‘e’, ‘P’, followed by four bytes of version information (two bytes for the protocol major and minor number, and two bytes of the encoding major and minor number). How to interpret the remainder of the header and the message body depends on the major and minor version.

These ground rules ensure that all current and future versions of the Ice run time can at least identify the version and size of an encapsulation and a message. This is particularly important for message switches such as IceStorm (see Chapter 43);

by keeping the version and size information in a fixed format, it is possible to forward messages that are, for example, at version 2.0, even though the message switch itself may still be at version 1.0.

34.5.2 Version Compatibility Rules

To establish whether a particular protocol version is compatible with another protocol version (or a particular encoding version is compatible with another encoding version), the following rules apply:

1. Different major versions are incompatible. There is no obligation on either clients or servers to support more than a single major version. For example, a server with major version 2 is under no obligation to also support major version 1.

This rule exists to permit the Ice run time to eventually get rid of old versions—without such a rule, all future releases of Ice would have to support all previous major versions forever. In plain language, the rule means that clients and servers that use different major versions simply cannot communicate with each other.

2. A receiver that advertises minor version n guarantees to be able to successfully decode all minor versions less than n . Note that this does *not* imply that messages using version $n-1$ can be decoded as if they were version n : as far as their physical representation is concerned, two adjacent minor versions can be completely incompatible. However, because any receiver advertising version n is also obliged to correctly deal with version $n-1$, minor version upgrades are *semantically* backward compatible, even though their physical representation may be incompatible.
3. A sender that supports minor version n guarantees to be able to send messages using all minor versions less than n . Moreover, the sender guarantees that if it receives a request using minor version k (with $k \leq n$), it will send the reply for that request using minor version k .

34.5.3 Version Negotiation

Client and server must somehow agree on which version to use to exchange messages. Depending on whether the underlying transport is connection-oriented or connection-less, different mechanisms are used to negotiate a common version.

Negotiation for Connection-Oriented Transports

For connection-oriented transports, the client opens a connection to the server and then waits for a validate connection message (see page 989). The validate connection message sent by the server indicates the server's major and highest supported minor version numbers for both protocol and encoding. If the server's and client's major version numbers do not match, the client side raises an `UnsupportedProtocolException` or `UnsupportedEncodingException`.

Assuming that the client has received a validate connection message from the server that matches the client's major version, the client knows the highest minor version number that is supported by the server. Thereafter, the client is obliged to send no message with a minor version number higher than the server's limit. However, the client is free to send a message with a minor version number that is less than the server's limit.

The server does not have a-priori knowledge of the highest minor version that is supported by the client (because there is no validate connection message from client to server). Instead, the server learns about the client version number in each individual message, by looking at the message header. That minor version indicates the minor version number that the client can accept. The scope of that minor version number is a single request-reply interaction. For example, if the client sends a request with minor version 3, the server must reply to that request with minor version 3 as well. However, the next client request might be with minor version 2, and the server must reply to that request with minor version 2.

For orderly connection closure via a close connection message, the server can use any minor version, but that minor version must not be higher than the highest minor version number that was received from the client while the connection was open.

Negotiation for Connection-Less Transports

For connection-less transports, no validate connection message exists, so the client must learn about the highest supported minor version number of the server via other means. The mechanism for this depends on whether a proxy for a connection-less endpoint is bound directly or indirectly (see page 13):

- For direct proxies, the version information is part of the endpoint contained in the proxy. In this case, the client simply sends its messages with a minor version number that is not greater than the minor version number of the endpoint in the proxy.
- For indirect proxies, the proxy itself contains no version information at all (because the proxy contains no endpoints). Instead, the client obtains the

version information when it resolves the proxy's symbolic information to one or more endpoints (via IceGrid or an equivalent service). The version information of the endpoints determines the highest minor version number that is available to the client.

34.6 A Comparison with IIOP

It is interesting to compare the Ice protocol and encoding with CORBA's Inter-ORB Interoperability Protocol (IIOP) and Common Data Representation (CDR) encoding. The Ice protocol and encoding differ from IIOP and CDR in a number of important respects:

- Fewer data types

CORBA IDL has data types that are not provided by Ice, such as characters and wide characters, fixed-point numbers, arrays, and unions, each of which require a separate set of encoding rules.

Obviously, fewer data types makes the Ice encoding more efficient and less complex than CDR.

- Fixed byte-order marshaling

CDR supports both big-endian and little-endian encoding and provides a "receiver-makes-it-right" approach to byte ordering. The advantage of this is that, if sender and receiver have matching byte order, no reordering of the data is required at either end. However, the disadvantage is the additional complexity this creates in the marshaling logic. Moreover, the "receiver-makes-it-right" scheme carries a severe performance penalty if messages are to be forwarded via a number of intermediaries because this can require repeated unmarshaling, reordering, and remarshaling of messages. (Encapsulating the data would avoid this problem but, unfortunately, IIOP does not encapsulate most of the data that would benefit from it.)

The Ice encoding uses fixed little-endian data layout and avoids both the complexity and performance penalty.

- No padding

CDR has a complex set of rules for inserting alignment bytes into a data stream in an attempt to keep data aligned in a way that suits the native data layout of the underlying hardware. Unfortunately, this approach is severely flawed for a number of reasons:

- The CDR padding rules actually do not achieve any layout on natural word boundaries. For example, depending on its relative position in the enclosing data stream, the same structure value can differ in size and padding by up to seven bytes. There is not a single hardware platform in existence whose layout rules are the same as those of CDR. As a result, the padding bytes that are inserted serve no purpose other than to waste bandwidth.
- With “receiver-makes-it-right”, the receiver is obliged to re-order data if it arrives in the incorrect byte order anyway. This means that any alignment of the data (even if it were correct) is useless to, on average, half of all receivers because re-ordering of the data requires copying all of the data anyway.
- Padding and alignment rules differ depending on the hardware platform as well as the compiler. (For example, many compilers provide options that change the way data is packed in memory, to allow the developer to control the time-versus-space trade-off.) This means that even the best set of layout rules can suit only a minority of platforms.
- Data alignment rules greatly complicate data forwarding. For example, if the receiver of a data item wants to forward that data item to another downstream receiver, it cannot just block-copy the received data into its transmit buffer because the padding of the data is sensitive to its relative position in the enclosing byte stream and a block copy would most likely result in an illegal encoding.

Ice avoids all the complexity (and concomitant inefficiency) by aligning all data on byte boundaries.

- More compact encoding

CDR encoding rules are wasteful of bandwidth, especially for sequences of short data items. For example, with CDR encoding, an empty string occupies eight bytes: four bytes to store the string length, plus a single terminating NUL byte, plus three bytes of padding. Table 34.19 compares the encoding sizes of

CDR and the Ice encoding for sequences of 100 strings for different string lengths.

Table 34.19. Sizes of CDR and Ice sequences of 100 strings of different lengths.

Sequence of 100 Strings of Length	CDR Size	Ice Size	Extra cost of CDR
0	804	101	696%
4	1204	501	140%
8	1604	901	78%
16	2004	1701	18%

Similar savings are achieved for small structures. Depending on the order and type of the structure members, CDR padding bytes can almost double the structure size, which becomes significant when sending sequences of such structures.

- Simple proxy encoding

Due to the inability of CORBA vendors to agree on a common encoding for object references (the equivalent of Ice proxies), CORBA object references have a complex internal structure that is partially standardized and partially opaque, allowing vendors to add proprietary information to object references. In addition, to avoid object references getting too large, references that support more than one transport have a scheme for sharing the object identity among several transports instead of carrying multiple copies of the same identity. The encoding that is required to support all this machinery is quite complex and results in extremely poor marshaling performance when large number of object references are exchanged (for example, when using a trading service).

In contrast, Ice proxies are simple and straight-forward to marshal and do not incur this loss of performance.

- Proper version negotiation

Versioning for IIOP and CDR was never designed properly, with the result that version negotiation in IIOP simply does not work. In particular, CDR encapsulations do not carry a separate version number. As a result, it is possible for data in encapsulations to travel to receivers that cannot decode the contents of the encapsulation, with no mechanism at the protocol level to detect the problem. Lack of correct versioning has been an ongoing problem with CORBA for years and the problem has historically been dealt with by pretending that it does not exist (meaning that different CORBA versions cannot interoperate with each other in many circumstances).

The Ice protocol and encoding have well-defined versioning rules that avoid such problems, allow both protocol and encoding to be extended, and reliably detect version mismatches.

- Fewer message types

IIOP has more message types than Ice. For example, IIOP has both a cancel request and a message error message. The cancel request is meant to cancel an invocation in progress but, of course, cannot do that because there is no way to abort an executing invocation in the server. At best, a cancel request allows the server to avoid marshaling the results of an invocation back to the client. However, the additional complexity introduced into the protocol is not worth the saving. (And, at any rate, neither is there a way for an application developer to send a cancel request, nor can the run time decide on its own when it would be appropriate to send one; despite that, every compliant CORBA implementation is burdened by the need to correctly respond to a useless request.)

IIOP's message error message constitutes similar baggage: the receiver of a malformed message is obliged to respond with a message error message before closing its connection. However, the message carries no useful information and, due to the nature of TCP/IP implementations, is usually lost instead of being delivered. This means that a compliant CORBA implementation is forced to send a useless message that will not be received in most cases when, instead, it should simply close the connection.

Ice avoids any such baggage in its protocol: the messages that are used actually serve a useful purpose.

- Request batching

IIOP has no notion of request batching. The advantages of request batching are particularly noticeable for event forwarding mechanisms, such as IceS-

form (see Chapter 43), as well as for fine-grained interfaces that provide modifier operations for a number of attributes. Request batching significantly reduces networking overhead for such applications.

- **Reliable connection establishment**

IIOP is vulnerable to connection loss during connection establishment. In particular, when a client opens a connection to a server, the client has no way of knowing whether the server is about to shut down and will not be able to process an incoming request. This means that the client has no choice but to send a request on a newly-established connection in the hope that the request will actually be processed by the server. If the server can process the request, there is no problem. However, if the server cannot process the request because it is on its way down, the client is confronted with a broken connection and cannot re-issue the request because that might violate at-most-once semantics. Ice does not have this problem because the validate connection message ensures that the client will not send a request to a server that is about to shut down. Moreover, any requests with outstanding replies can safely be re-issued by the client without violating at-most-once semantics.

- **Reliable endpoint resolution**

Indirect binding (see page 13) in IIOP relies on a locate forward reply. Briefly, endpoint resolution is transparent to clients using IIOP. If an object reference uses indirect binding, the client issues the request as usual and receives a locate forward reply containing the endpoint of the actual server. In response to that reply, the client issues the request a second time to contact the actual server. There are a number of problems with this scheme:

- The physical address of the location service is written into each indirectly bound object reference. This makes it impossible to move the location service without invalidating all the references held by clients.⁴

Ice does not have this problem because the location service is known to clients through configuration. If the location service is moved, clients can be updated by changing their configuration and there is no need to track down a potentially unlimited number of proxies that might be out of date. Moreover,

4. IIOP version 1.2 supported a message to indicate permanent location forwarding. That message was meant to ease migration of location services. However, the semantics of that message broke the object model elsewhere, with the result that IIOP version 1.3 has deprecated that message again. (Unfortunately, reversals such as this are all too common in OMG specifications.)

there is typically no need to move the location service. Instead, it is possible to construct federated location services that work similar to the Internet Domain Name Service (DNS) and internally forward requests to the correct resolver.

- In order to get a location forward message, clients send the actual request to the location service. This is expensive if the request parameters are large because they are marshaled twice: once to the location service and once to the actual server. IIOP adds a locate request message that allows a client to explicitly resolve the location of a server. However, CORBA object references carry no indication as to whether they are bound directly or indirectly. This means that, no matter what the client does, it is wrong some of the time: if the client always uses a locate request with a directly bound reference, it ends up incurring the cost of two remote messages instead of one; if the client sends the request directly with an indirectly bound reference, it incurs the cost of marshaling the parameters twice instead of once.

Ice makes location resolution a step that is explicitly visible to the client-side run time because proxies either carry endpoint information (for direct proxies) or symbolic information (for indirect proxies). This allows the client-side run time to select the correct resolution mechanism without having to play guessing games and to avoid the overhead incurred by location forwarding.

- With IIOP, location resolution is built into the protocol itself. This complicates the protocol with two additional message types and (until 2002, when additional APIs were added to CORBA) made it impossible to implement a location service using standard APIs.

With Ice, no special protocol support is required for location resolution. Instead, the location service is an ordinary Ice server that defines an interface as usual and is contacted using operation invocations like any other server.

- No codeset negotiation

IIOP uses a codeset negotiation feature that (supposedly) permits use of arbitrary character encodings for transmission of wide characters and strings, provided sender and receiver have at least one codeset in common. Unfortunately, this feature was never properly thought through and has repeatedly led to interoperability problems. (Every single version of the CORBA specification, including the latest 3.0 version, has made corrections to the way codeset negotiation is supposed to work. Whether the latest set of corrections will

succeed in dealing with the problem remains to be seen. Regardless, many pages of complexity (and many lines of ORB source code) are devoted to this (mis)feature.)

The UTF-8 encoded Unicode used by Ice avoids all these problems without losing any functionality.

- No fragmentation

IIOP provides a fragment message whose purpose it is to reduce memory overhead in the server during marshaling of the results of an operation invocation. Unfortunately, the feature is quite complex (having been mis-specified and mis-implemented repeatedly in the past). The savings to be gained through fragmentation are quite limited, yet every client-side ORB implementation is forced to provide support for the feature. (In other words, the cure is worse than the disease.)

Ice simply does not use a fragmentation scheme, avoiding both the complexity and the resulting code bloat.

- Support for connection-less transports

In 2001, the OMG adopted a multi-cast specification. To the best of our knowledge, as of early 2003, no implementations of that specification are available.

Ice offers UDP as an alternative to TCP/IP. For messaging services, such as IceStorm, the performance benefits of UDP are considerable, allowing the service to scale well beyond what could be achieved with TCP/IP.

Chapter 35

Connection Management

35.1 Chapter Overview

In this chapter we describe the semantics of Ice connections. Section 35.3 defines the rules for connection establishment, including the consequences of connection failure and the effects of timeouts. Section 35.4 provides details about active connection management and when to use it. Section 35.5 demonstrates how Ice applications gain access to connections, while Section 35.6 describes how a connection is closed. Finally, Section 35.7 presents bidirectional connections and describes their use cases and configuration.

35.2 Introduction

The Ice run time establishes connections automatically and transparently as a side effect of using proxies. There are well-defined rules that determine when a new connection is established (see Section 35.3). If necessary, you can influence connection management activities (see Section 35.4).

Connection management becomes increasingly important as network environments grow more complex. In particular, if you need to make callbacks from a server to a client through a firewall, you must use a bidirectional connection. In most cases, you can use a Glacier2 router (see Chapter 41) to automatically take

advantage of bidirectional connections. However, the Ice run time also provides direct access to connections, allowing you to explicitly control establishment and closure of both unidirectional and bidirectional connections.

The discussion that follows assumes that you are familiar with proxies and endpoints (see Section 31.10 and Appendix D).

35.3 Connection Establishment

Connections are established as a side effect of using proxies. The first invocation on a proxy causes the Ice run time to search for an existing connection to one of the proxy's endpoints (see Section 31.10.2); only if no suitable connection exists does the Ice run time establish a new connection to one of the proxy's endpoints.

35.3.1 Endpoint Selection

A proxy performs a number of operations on its endpoints before it asks the Ice run time to supply a connection. These operations produce a list of zero or more endpoints that satisfy the proxy's configuration. If the resulting list is empty, the application receives `NoEndpointException` to indicate that no suitable endpoints could be found. For example, this situation can arise when a twoway proxy contains only a UDP endpoint; the UDP endpoint is eliminated from consideration because it cannot be used for twoway invocations.

The proxy performs the following steps to derive its endpoint list:

1. Remove the endpoints of unknown transports. For instance, SSL endpoints are removed if the SSL plug-in is not installed.
2. Remove endpoints that are not suitable for the proxy's invocation mode.
3. Sort the endpoints according to the configured selection type, which is established using the `ice_endpointSelection` factory method. The default value is `Random`, meaning the endpoints are randomly shuffled. Alternatively, the value `Ordered` maintains the existing order of the endpoints.
4. If the proxy is configured for secure communication, remove all non-secure endpoints. Otherwise, rearrange the endpoints so that non-secure endpoints appear before secure endpoints.

The proxy iterates over this list and requests a connection from the Ice run time until one of the endpoints succeeds or all have failed. The Ice run time returns an

existing connection if it is suitable for reuse (see Section 35.3.3), otherwise it attempts to establish a new connection to the endpoint.

35.3.2 Error Handling

If a failure occurs during a connection attempt, the Ice run time tries to connect to all of the proxy's remaining endpoints until either a connection is successfully established or all attempts have failed. At that point, the behavior of the Ice run time depends on the value of the `Ice.RetryIntervals` configuration property (see Appendix C). The default value of this property is 0, which causes the Ice run time to try connecting to all of the endpoints one more time¹. If no connection can be established on this second attempt, the Ice run time raises the first exception that caused the request to fail. For example, if the failure occurred while establishing a new connection, the Ice run time raises `ConnectFailedException`. Similarly, if a connection was lost during a request and could not be reestablished, the Ice run time raises `ConnectionLostException`.

35.3.3 Connection Reuse

When establishing a connection for a proxy, the Ice run time reuses an existing connection under the following conditions:

- The remote endpoint matches one of the proxy's endpoints.
- The connection was established by the communicator that created the proxy.
- The connection matches the proxy's configuration. Timeout values play an important role here, as an existing connection is only reused if its timeout value (i.e., the timeout used when the connection was established) matches the new proxy's timeout (see Section 35.3.5). Similarly, a proxy configured with a connection id only reuses a connection if it was established by a proxy with the same connection id.

Multiple Endpoints

Applications must exercise caution when using proxies containing multiple endpoints, especially endpoints using different transports. For example, suppose a proxy has multiple endpoints, such as one each for TCP, SSL, and UDP. When

1. Define the property `Ice.Trace.Retry=2` to monitor these attempts.

establishing a connection for this proxy, the Ice run time will open a new connection only if it cannot reuse an existing connection to any of the endpoints. Furthermore, the proxy in its default (i.e., non-secure) configuration gives higher priority to non-secure endpoints. If you want to ensure that a particular transport is used by a proxy, you must configure the proxy appropriately, such as by calling the `ice_secure` or `ice_datagram` factory methods described in Section 31.10.1.

Compression

The Ice run time does not consider compression settings when searching for existing connections to reuse; proxies whose compression settings differ can share the same connection (assuming all other selection criteria are satisfied).

Application Control

The default behavior of the Ice run time, which reuses connections whenever possible, is appropriate for many applications because it conserves resources and typically has little or no impact on performance. However, when a server implementation attaches semantics to a connection, the client often must be designed to cooperate, despite the tighter coupling it causes. For example, a server might use the thread-per-connection concurrency model (see Section 31.9) in order to serialize the requests received over each connection. If the client wants to execute several requests simultaneously, it must be able to force the Ice run time to establish new connections at will.

For those situations that require more control over connection reuse, the Ice run time allows you to form arbitrary groups of proxies that share a connection by configuring them with the same connection identifier. The factory function `ice_connectionId` (see Section 31.10.1) returns a new proxy configured with the given connection id. Once configured, the Ice run time ensures that the proxy only reuses a connection that was established by a proxy with the same connection id (assuming all other criteria for connection reuse are also satisfied). A new connection is created if none with a matching id is found, which means each proxy could conceivably have its own connection if each were assigned a unique connection id.

As an example, consider the following code fragment:

```
// C++
Ice::ObjectPrx prx = comm->stringToProxy("ident:tcp -p 10000");
Ice::ObjectPrx g1 = prx->ice_connectionId("group1");
Ice::ObjectPrx g2 = prx->ice_connectionId("group2");
prx->ice_ping(); // Opens a new connection
```

```
g1->ice_ping(); // Opens a new connection
g2->ice_ping(); // Opens a new connection
MyInterfacePrx i1 = MyInterfacePrx::checkedCast(g1);
i1->ice_ping(); // Reuses g1's connection
MyInterfacePrx i2 = MyInterfacePrx::checkedCast(
    prx->ice_connectionId("group2"));
i2->ice_ping(); // Reuses g2's connection
```

A total of three connections are established by this example:

1. The proxy `prx` establishes a new connection. This proxy has the default connection id (an empty string).
2. The proxy `g1` establishes a new connection because the only existing connection, the one established by `prx`, has a different connection id.
3. Similarly, the proxy `g2` establishes a new connection because none of the existing connections have a matching connection id.

The proxy `i1` inherits its connection id from `g1`, and therefore shares the connection for `group1`; `i2` explicitly configured its connection id and shares the `group2` connection with proxy `g2`.

35.3.4 Connection Caching

When we refer to a proxy's connection, we actually mean the connection that the proxy is *currently* using. This connection can change over time, such that a proxy might use several connections during its lifetime. For example, an idle connection may be closed automatically and then transparently replaced by a new connection when activity resumes (see Section 35.4).

After establishing a connection in response to proxy activities, the Ice run time adds the connection to an internal pool for subsequent reuse by other proxies (see Section 35.3.3). The Ice run time manages the lifetime of the connection; it is eventually closed as described in Section 35.6. The connection is not affected by the lifecycle of the proxies that use it, except that the lack of activity may prompt the Ice run time to close the connection after a while.

Once a proxy has been associated with a connection, the proxy's default behavior is to continue using that connection for all subsequent requests. In effect, the proxy caches the connection and attempts to use it for as long as possible in order to minimize the overhead of creating new connections. If the connection is later closed and the proxy is used again, the proxy repeats the connection-establishment procedure described in Section 35.3.1.

There are situations in which this default caching behavior is undesirable, such as when a client has a proxy with multiple endpoints and wishes to balance the load among the servers at those endpoints. The client can disable connection caching by passing an argument of `false` to the proxy factory method `ice_connectionCached`. The new proxy returned by this method repeats the connection-establishment procedure outlined in Section 35.3.1 before each request, thereby achieving request load balancing at the expense of potentially higher latency. (Refer to Chapter 37 for information on other forms of load balancing.)

35.3.5 Timeouts

A proxy's default configuration has a timeout value of `-1`, meaning that network activity initiated by this proxy does not time out. The timeout value affects both connection establishment and remote invocations. If a different timeout value is specified and the connection cannot be established within the allotted time, a `ConnectTimeoutException` is raised.

You can set a timeout on a proxy using the `ice_timeout` factory method (see Section 31.10.1). To use the same timeout period for all proxies, you can define the `Ice.Override.Timeout` property; in this case, any timeout established using the `ice_timeout` factory method is ignored. Finally, if you want to specify a separate timeout value that affects only connection establishment and takes precedence over a proxy's configured timeout value, you can define the `Ice.Override.ConnectTimeout` property. (See Appendix C for more information on these properties, and Section 31.12 for more information on invocation timeouts.)

The timeout in effect when a connection is established is bound to that connection and affects all requests on that connection. If a request times out, all other outstanding requests on the same connection also time out, and the connection is closed forcefully (see Section 35.5.4). The Ice run time automatically retries these requests on a new connection, assuming that automatic retries are enabled and would not violate at-most-once semantics (see page 16).

35.4 Active Connection Management

Active Connection Management (ACM) is enabled by default and helps to improve scalability and conserve application resources by closing idle connections.

35.4.1 Configuring ACM

ACM is configured separately for client (outgoing) and server (incoming) connections using the properties `Ice.ACM.Client` and `Ice.ACM.Server`, respectively. The default value of `Ice.ACM.Client` is 60, meaning an outgoing connection is closed if it has not been used for sixty seconds. The default value of `Ice.ACM.Server` is zero, which disables ACM for incoming connections. Ice disables server ACM by default because it can cause incoming oneway requests to be silently discarded, as discussed in Section 31.13.

The decision to close a connection is not based only on a lack of network activity. For example, a request may take longer to complete than the configured idle time. Therefore, ACM does not close a connection if there are outgoing or incoming requests pending on that connection, or if a batch request is being accumulated for that connection.

When it is safe to close the connection, it is done gracefully as described in Section 35.6. The closure is usually transparent to the client and server applications because the connection is reestablished automatically when necessary. We say connection closure is “usually transparent” because it is possible that the Ice run time will be unable to reestablish a connection for a variety of reasons (see Section 35.4.2). In such a situation, the application receives a `ConnectFailedException` for new requests, and `CloseConnectionException` for pending requests.

It is important that you choose an idle time that does not result in excessive connection closure and reestablishment. The default value of sixty seconds is a reasonable default, but your requirements may determine a more appropriate value.

35.4.2 Disabling ACM

Since server ACM is disabled by default, you only need to set `Ice.ACM.Client` to 0 to disable ACM for all connections. In this configuration a connection is not closed until its communicator is destroyed or it is closed explicitly by the application (see Section 35.5.4). It is important to note that disabling ACM in a process does not prevent a remote peer from closing a connection; all peers must be properly configured in order to truly disable ACM.

There are certain situations in which it is necessary to disable ACM. For example, oneway requests can be silently discarded when a connection is closed (see Section 31.13). As another example, ACM must be disabled when using bidirectional connections. A bidirectional connection is enabled by using a router such as `Glacier2` (see Chapter 41) or by configuring a connection explicitly (see

Section 35.7). If you do not disable ACM in such cases, ACM can prematurely close a bidirectional connection and thereby cause callbacks to fail unexpectedly.

35.5 Obtaining a Connection

Applications can gain access to an Ice object representing an established connection.

35.5.1 The `Ice::Connection` Interface

The Slice definition of the `Connection` interface is shown below:

```
module Ice {
    local interface Connection {
        void close(bool force);
        nonmutating Object* createProxy(Identity id);
        void setAdapter(ObjectAdapter adapter);
        nonmutating ObjectAdapter getAdapter();
        void flushBatchRequests();
        nonmutating string type();
        nonmutating int timeout();
        nonmutating string toString();
    };
};
```

As indicated in the Slice definition, a connection is a local object, similar to a communicator or an object adapter. A connection object therefore is only usable within the process and cannot be accessed remotely.

The `Connection` interface supports the following operations:

- `void close(bool force)`
Explicitly closes the connection. The connection is closed gracefully if `force` is false, otherwise the connection is closed forcefully. See Section 35.5.4 for more information.
- `Object* createProxy(Identity id)`
Creates a special proxy that only uses this connection. See Section 35.7 for more information.
- `void setAdapter(ObjectAdapter adapter)`
Enables callbacks over this connection. See Section 35.7 for more information.

- `ObjectAdapter getAdapter()`
Returns the object adapter associated with this connection, or nil if no association has been made.
- `void flushBatchRequests()`
Flushes any pending batch requests for this connection.
- `string type()`
Returns the connection type as a string, such as “tcp”.
- `int timeout()`
Returns the timeout value used when the connection was established.
- `string toString()`
Returns a readable description of the connection.

35.5.2 Clients

Clients obtain a connection by calling `ice_getConnection` on a proxy (see Section 31.10.1). If the proxy does not yet have a connection, the `ice_getConnection` method attempts to establish one. As a result, the caller must be prepared to handle connection failure exceptions as described in Section 35.3.2.

Furthermore, if the proxy denotes a collocated object and collocation optimization is enabled, calling `ice_getConnection` results in a `CollocationOptimizationException`.

As an example, the C++ code below illustrates how to obtain a connection from a proxy and print its type:

```
Ice::ObjectPrx proxy = ...
try
{
    Ice::ConnectionPtr conn = proxy->ice_getConnection();
    cout << conn->type() << endl;
}
catch(const Ice::CollocationOptimizationException&)
{
    cout << "collocated" << endl;
}
```

35.5.3 Servers

Servers can access a connection via the `con` member of the `Ice::Current` parameter passed to every operation (see Section 31.6). For collocated invocations, `con` has a `nil` value.

For example, this Java code shows how to invoke `toString` on the connection:

```
public int add(int a, int b, Ice.Current curr)
{
    if (curr.con != null)
    {
        System.out.println("Request received on connection:\n" +
                           curr.con.toString());
    }
    else
    {
        System.out.println("collocated invocation");
    }
    return a + b;
}
```

Although the mapping for the `Slice` operation `toString` results in a Java method named `_toString`, the Ice run time implements `toString` to return the same value.

35.5.4 Closing a Connection

Applications should rarely need to close a connection explicitly, but those that do must be aware of its implications. Since there are two ways to close a connection, we discuss them separately.

Graceful Closure

Passing an argument of `false` to the `close` operation initiates graceful connection closure, as discussed in Section 35.6. The operation blocks until all pending outgoing requests on the connection have completed.

Forceful Closure

A forceful closure is initiated by passing an argument of `true` to the `close` operation, causing the peer to receive a `ConnectionLostException`.

A client must use caution when forcefully closing a connection. Any outgoing requests that are pending on the connection when `close` is invoked will fail with a

`ForcedCloseConnectionException`. Furthermore, requests that fail with this exception are not automatically retried.

Forceful closure can be useful as a defense against hostile clients. For example, the Glacier2 router implementation forcefully closes a connection from a client that has not first created a session.

The Ice run time interprets a `CloseConnectionException` to mean that it is safe to retry the request without violating at-most-once semantics (see page 16). If automatic retries are enabled, a client must only initiate a graceful close when it knows that there are no outgoing requests in progress on that connection, or that any pending requests can be safely retried.

35.6 Connection Closure

The Ice run time may close a connection for many reasons, including the situations listed below:

- When deactivating an object adapter or shutting down a communicator
- As required by active connection management (see Section 35.4)
- When initiated by an application (see Section 35.5.4)
- After a request times out (see Section 35.3.5)
- In response to an exception, such as a socket failure or protocol error.

In most cases, the Ice run time closes a connection gracefully as required by the Ice protocol (see Section 34.3.6). The Ice run time only closes a connection forcefully when a timeout occurs or when the application explicitly requests it.

35.6.1 Graceful Connection Closure

Gracefully closing a connection occurs in stages:

- In the process that initiates closure, incoming and outgoing requests that are in progress are allowed to complete, and then a close connection message is sent to the peer. Any incoming requests received after closure is initiated are silently discarded (but may be retried, as discussed in the next bullet). An attempt to make a new outgoing request on the connection results in a `CloseConnectionException` and an automatic retry (if enabled).
- Upon receipt of a close connection message, the Ice run time in the peer closes its end of the connection. Any outgoing requests still pending on that connec-

tion fail with a `CloseConnectionException`. This exception indicates to the Ice run time that it is safe to retry those requests without violating at-most-once semantics (see page 16), assuming automatic retries have not been disabled.

- After detecting that the peer has closed the connection, the initiating Ice run time closes the connection.

35.6.2 Impact on Oneway Invocations

As discussed in Section 31.13, oneway invocations are generally considered reliable because they are sent over a stream-oriented transport. However, it is quite possible for oneway requests to be silently discarded if a server has initiated graceful connection closure (see Section 35.6.1). Whereas graceful closure causes a discarded twoway request to receive a `CloseConnectionException` and eventually be retried, the sender receives no notice about a discarded oneway request.

If an application makes assumptions about the reliability of oneway requests, it may be necessary to control the events surrounding connection closure as much as possible, for example by disabling active connection management (see Section 35.4) and avoiding explicit connection closures.

35.7 Bidirectional Connections

An Ice connection normally allows requests to flow in only one direction. If an application's design requires the server to make callbacks to a client, the server normally establishes a new connection to that client in order to send callback requests, as shown in Figure 35.1.

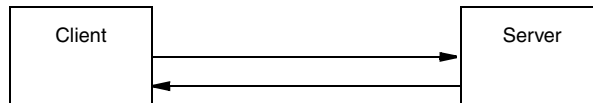

Figure 35.1. Callbacks in an open network.

Unfortunately, network restrictions often prevent a server from being able to create a separate connection to the client, such as when the client resides behind a firewall as shown in Figure 35.2.

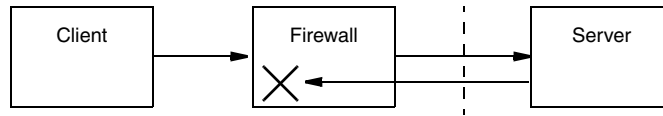

Figure 35.2. Callbacks with a firewall.

In this scenario, the firewall blocks any attempt to establish a connection directly to the client.

For situations such as these, a bidirectional connection offers a solution. Requests may flow in both directions over a bidirectional connection, enabling a server to send callback requests to a client over the client’s existing connection to the server.

There are two ways to make use of a bidirectional connection. First, you can use a Glacier2 router, in which case bidirectional connections are used automatically. If you do not require the functionality offered by Glacier2 or you do not want an intermediary service between clients and servers, you can configure bidirectional connections manually.

The remainder of this section discusses manual configuration of bidirectional connections. For more information on using a Glacier2 router, see Chapter 41.

35.7.1 Client Configuration

A client needs to perform the following steps in order to configure a bidirectional connection:

1. Create an object adapter to receive callback requests. This adapter does not require endpoints if its only purpose is to receive callbacks over bidirectional connections.
2. Register the callback object with the object adapter.
3. Activate the object adapter.
4. Obtain the `Ice::Connection` object (see Section 35.5.1) by calling `ice_getConnection` on the proxy.

5. Invoke `setAdapter` on the connection, passing the callback object adapter. This associates an object adapter with the connection and enables callback requests to be dispatched.
6. Pass the identity of the callback object to the server.

The C++ code below illustrates these steps:

```
Ice::ObjectAdapterPtr adapter =
    communicator->createObjectAdapter("CallbackAdapter");
Ice::Identity ident;
ident.name = IceUtil::generateUUID();
ident.category = "";
adapter->add(new CallbackI, ident);
adapter->activate();
proxy->ice_getConnection()->setAdapter(adapter);
proxy->addClient(ident);
```

The last step may seem unusual because a client would typically pass a proxy to the server, not just an identity. For example, you might be tempted to give the proxy returned by the adapter operation `add` to the server, but this would not have the desired effect: if the callback object adapter is configured with endpoints, the server would attempt to establish a separate connection to one of those endpoints, which defeats the purpose of a bidirectional connection. It is just as likely that the callback object adapter has no endpoints, in which case the proxy is of no use to the server.

Similarly, you might try invoking `createProxy` on the connection to obtain a proxy that the server can use for callbacks. This too would fail, because the proxy returned by the connection is for local use only and cannot be used by another process.

As you will see in the next section, the server must create its own callback proxy.

35.7.2 Server Configuration

A server needs to take the following steps in order to make callbacks over a bidirectional connection:

1. Obtain the identity of the callback object, which is typically supplied by the client.
2. Create a proxy for the callback object by calling `createProxy` on the connection. As discussed in Section 35.5.3, the connection object is accessible as a member of the `Ice::Current` parameter to an operation implementation.

These steps are illustrated in the C++ code below:

```
void addClient(const Ice::Identity& ident,
              const Ice::Current& curr)
{
    CallbackPrx client =
        CallbackPrx::uncheckedCast(curr.con->createProxy(ident));
    client->notify();
}
```

The proxy returned by the connection's `createProxy` operation is called a *fixed proxy*. It can only be used in the server process and cannot be marshaled or stringified by `proxyToString`. The fixed proxy is bound to the connection that created it, and ceases to work once that connection is closed. If the connection is closed prematurely, either by active connection management or by explicit action on the part of the application (see Section 35.4), the server can no longer make callback requests using that proxy. Any attempt to use the proxy again usually results in a `CloseConnectionException`.

35.7.3 Limitations

Bidirectional connections have certain limitations:

- They can only be configured for connection-oriented transports such as TCP and SSL.
- Most proxy factory methods have no effect on a proxy created by a connection's `createProxy` operation. The proxy is bound to an existing connection, therefore the proxy reflects the connection's configuration. For example, it is not possible to change the timeout value of such a proxy. Similarly, it is not possible to change the proxy's security configuration: if the incoming connection is secure, then the proxy must be secure, and cannot be changed to be insecure. However, it is legal to change between oneway and twoway invocations.
- A connection established from a Glacier2 router to a server is not configured for bidirectional use. Only the connection from a client to the router is bidirectional. However, the client must not attempt to manually configure a bidirectional connection to a router, as this is handled internally by the Ice run time.
- bidirectional connections are not compatible with active connection management (see Section 35.4).

35.7.4 Threading Considerations

The Ice run time normally creates two thread pools for processing network traffic on connections: the client thread pool manages outgoing connections and the server thread pool manages incoming connections. All of the object adapters in a server share the same thread pool by default, but an object adapter can also be configured to have its own thread pool. The default size of the client and server thread pools is one.

The client thread pool is normally waiting for the replies to pending requests. When a client configures an outgoing connection for bidirectional requests, the client thread pool also becomes responsible for processing requests received over that connection.

Similarly, the server thread pool normally dispatches requests from clients. If a server uses a connection to send callback requests, then the server thread pool must also process the replies to those requests.

You may need to increase the maximum size of a thread pool if you require more concurrency or to avoid deadlocks if you are using nested callbacks.

Refer to Section 31.9 for more information on the Ice threading model.

35.7.5 Example

An example that demonstrates how to configure a bidirectional connection is provided in the directory `demo/Ice/bidir`.

35.8 Summary

Most Ice applications benefit from active connection management and transparent connection establishment and thus need not concern themselves with the details of connections. Not all Ice applications can be so fortunate, and for those applications Ice provides convenient access to connections that enables developers to address the realities of today's deployment environments.

Chapter 36

Dynamic Ice

36.1 Chapter Overview

In this chapter we present a collection of Ice interfaces for a dynamic invocation and dispatch model. Section 36.2 discusses the streaming interface for serializing Slice types, an essential tool when implementing dynamic invocation and dispatch. The synchronous language mappings for the dynamic model are described in Section 36.3, while Section 36.4 covers the asynchronous language mappings.

36.2 Streaming Interface

Ice provides a convenient interface for streaming Slice types to and from a sequence of bytes. You can use this interface in many situations, such as when serializing types for persistent storage, and when using Ice's dynamic invocation and dispatch interfaces (see Section 36.3).

The streaming interface is not defined in Slice, but rather is a collection of native classes provided by each language mapping¹. A default implementation of

1. The streaming interface is currently supported in C++, Java, C#, and VisualBasic.

the interface uses the Ice encoding as specified in Section 34.2, but other implementations are possible.

There are two primary classes in the streaming interface: `InputStream` and `OutputStream`. As you might guess, `InputStream` is used to extract `Slice` types from a sequence of bytes, while `OutputStream` is used to convert `Slice` types into a sequence of bytes. The classes provide the functions necessary to manipulate all of the core `Slice` types:

- Primitives (`bool`, `int`, `string`, etc.)
- Sequences of primitives
- Proxies
- Objects

The classes also provide functions that handle various details of the Ice encoding. Using these functions, you can manually insert and extract constructed types, such as dictionaries and structures, but doing so is tedious and error-prone. To make insertion and extraction of constructed types easier, the `Slice` compilers can optionally generate helper functions that manage the low-level details for you.

The remainder of this section describes the streaming interface for each supported language mapping. To properly use the streaming interface, you should be familiar with the Ice encoding (see Section 34.2). An example that demonstrates the use of the streaming interface is located in `demo/Ice/invite` in the Ice distribution.

36.2.1 C++ Stream Interface

We discuss the stream classes first, followed by the helper functions, and finish with an advanced use case of the streaming interface.

InputStream

An `InputStream` is created using the following function:

```
namespace Ice {
    InputStreamPtr createInputStream(
        const Ice::CommunicatorPtr& communicator,
        const std::vector<Ice::Byte>& data);
}
```

The `InputStream` class is shown below.

```
namespace Ice {
    class InputStream : ... {
    public:
        Ice::CommunicatorPtr communicator() const;

        void sliceObjects(bool slice);

        bool readBool();
        std::vector< bool > readBoolSeq();

        Ice::Byte readByte();
        std::vector< Ice::Byte > readByteSeq();

        Ice::Short readShort();
        std::vector< Ice::Short > readShortSeq();

        Ice::Int readInt();
        std::vector< Ice::Int > readIntSeq();

        Ice::Long readLong();
        std::vector< Ice::Long > readLongSeq();

        Ice::Float readFloat();
        std::vector< Ice::Float > readFloatSeq();

        Ice::Double readDouble();
        std::vector< Ice::Double > readDoubleSeq();

        std::string readString();
        std::vector< std::string > readStringSeq();

        Ice::Int readSize();

        Ice::ObjectPrx readProxy();

        void readObject(const Ice::ReadObjectCallbackPtr& cb);

        std::string readTypeId();

        void throwException();

        void startSlice();
        void endSlice();
        void skipSlice();

        void startEncapsulation();
    };
};
```

```

        void endEncapsulation();

        void readPendingObjects();
    };
    typedef ... InputStreamPtr;
}

```

Member functions are provided for extracting all of the primitive types, as well as sequences of primitive types; these are self-explanatory. The remaining member functions have the following semantics:

- `void sliceObjects(bool slice)`
Determines the behavior of the stream when extracting Ice objects. An Ice object is “sliced” when a factory cannot be found for a Slice type id (see Section 34.2.11 for more information), resulting in the creation of an object of a less-derived type. Slicing is typically disabled when the application expects all object factories to be present, in which case the exception `NoObjectFactoryException` is raised. The default behavior is to allow slicing.
- `Ice::Int readSize()`
The Ice encoding has a compact representation to indicate size (see Section 34.2.1). This function extracts a size and returns it as an integer.
- `Ice::ObjectPrx readProxy()`
This function returns an instance of the base proxy type, `ObjectPrx`. The Slice compiler optionally generates helper functions to extract proxies of user-defined types (see page 1028).
- `void readObject(const Ice::ReadObjectCallbackPtr &)`
The Ice encoding for class instances requires extraction to occur in stages (see Section 34.2.11). The `readObject` function accepts a callback object of type `ReadObjectCallback`, whose definition is shown below:

```

namespace Ice {
    class ReadObjectCallback : ... {
    public:
        virtual void invoke(const Ice::ObjectPtr&) = 0;
    };
    typedef ... ReadObjectCallbackPtr;
}

```

```
}
```

When the object instance is available, the callback object's `invoke` member function is called. The application must call `readPendingObjects` to ensure that all instances are properly extracted.

Note that applications rarely need to invoke this member function directly; the helper functions generated by the Slice compiler are easier to use (see page 1028).

- `std::string readTypeId()`

A table of Slice type ids is used to save space when encoding Ice objects (see Section 34.2.11). This function returns the type id at the stream's current position.

- `void throwException()`

This function extracts a user exception from the stream and throws it. If the stored exception is of an unknown type, the function attempts to extract and throw a less-derived exception. If that also fails, an `UnmarshalOutOfBoundsException` is thrown.

- `void startSlice()`
`void endSlice()`
`void skipSlice()`

Start, end, and skip a slice of member data, respectively. These functions are used when manually extracting the slices of an Ice object or user exception. See Section 34.2.11 for more information.

- `void startEncapsulation()`
`void endEncapsulation()`

Start and end an encapsulation, respectively. See Section 34.2.2 for more information.

- `void readPendingObjects()`

An application must call this function after all other data has been extracted, but only if Ice objects were encoded. This function extracts the state of Ice objects and invokes their corresponding callback objects (see `readObject`).

Here is a simple example that demonstrates how to extract a boolean and a sequence of strings from a stream:

```

std::vector< Ice::Byte > data = ...
Ice::InputStreamPtr in =
    Ice::createInputStream(communicator, data);
bool b = in->readBool();
std::vector< std::string > seq = in->readStringSeq();

```

OutputStream

An OutputStream is created using the following function:

```

namespace Ice {
    OutputStreamPtr createOutputStream(
        const Ice::CommunicatorPtr& communicator);
}

```

The OutputStream class is shown below.

```

namespace Ice {
    class OutputStream : ... {
    public:
        Ice::CommunicatorPtr communicator() const;

        void writeBool(bool v);
        void writeBoolSeq(const std::vector<bool>& v);

        void writeByte(Ice::Byte v);
        void writeByteSeq(const std::vector<Ice::Byte>& v);

        void writeShort(Ice::Short v);
        void writeShortSeq(const std::vector<Ice::Short>& v);

        void writeInt(Ice::Int v);
        void writeIntSeq(const std::vector<Ice::Int>& v);

        void writeLong(Ice::Long v);
        void writeLongSeq(const std::vector<Ice::Long>& v);

        void writeFloat(Ice::Float v);
        void writeFloatSeq(const std::vector<Ice::Float>& v);

        void writeDouble(Ice::Double v);
        void writeDoubleSeq(const std::vector<Ice::Double>& v);

        void writeString(const std::string& v);
        void writeStringSeq(const std::vector<std::string>& v);

        void writeSize(Ice::Int sz);
    };
}

```



```
void writeProxy(const Ice::ObjectPrx& v);

void writeObject(const Ice::ObjectPtr& v);

void writeTypeId(const std::string& id);

void writeException(const Ice::UserException& ex);

void startSlice();
void endSlice();

void startEncapsulation();
void endEncapsulation();

void writePendingObjects();

void finished(std::vector<Ice::Byte>& data);
};
}
```

Member functions are provided for inserting all of the primitive types, as well as sequences of primitive types; these are self-explanatory. The remaining member functions have the following semantics:

- `void writeSize(Ice::Int sz)`
The Ice encoding has a compact representation to indicate size (see Section 34.2.1). This function converts the given integer into the proper encoded representation.
- `void writeObject(const Ice::ObjectPtr & v)`
Inserts an Ice object. The Ice encoding for class instances (see Section 34.2.11) may cause the insertion of this object to be delayed, in which case the stream retains a reference to the given object and does not insert its state until `writePendingObjects` is invoked on the stream.
- `void writeTypeId(const std::string & id)`
A table of Slice type ids is used to save space when encoding Ice objects (see Section 34.2.11). This function adds the given type id to the table and encodes the type id.
- `void writeException(const Ice::UserException & ex)`
Inserts a user exception.

- `void startSlice()`
`void endSlice()`
Starts and ends a slice of object or exception member data (see Section 34.2.11).
- `void startEncapsulation()`
`void endEncapsulation()`
Starts and ends an encapsulation, respectively (see Section 34.2.2).
- `void writePendingObjects()`
Encodes the state of Ice objects whose insertion was delayed during `writeObject`. This member function must only be called once.
- `void finished(std::vector< Ice::Byte > & data)`
Indicates that marshaling is complete. The given byte sequence is filled with the encoded data. This member function must only be called once.

Here is a simple example that demonstrates how to insert a boolean and a sequence of strings into a stream:

```
std::vector< Ice::Byte > data;
std::vector< std::string > seq;
seq.push_back("Ice");
seq.push_back("rocks!");
Ice::OutputStreamPtr out = Ice::createOutputStream(communicator);
out->writeBool(true);
out->writeStringSeq(seq);
out->finished(data);
```

Helper Functions

The stream classes provide all of the low-level functions necessary for encoding and decoding Ice types. However, it would be tedious and error-prone to manually encode complex Ice types such as classes, structs, and dictionaries using these low-level functions. For this reason, the Slice compiler (see Section 6.15) optionally generates helper functions for streaming complex Ice types.

We will use the following Slice definitions to demonstrate the language mapping:

```
module M {
    sequence<...> Seq;
    dictionary<...> Dict;
    struct S {
        ...
    };
};
```

```
    enum E { ... };  
    class C {  
        ...  
    };  
};
```

The Slice compiler generates the corresponding helper functions shown below:

```
namespace M {  
void ice_readSeq(const Ice::InputStreamPtr&, Seq&);  
void ice_writeSeq(const Ice::OutputStreamPtr&, const Seq&);  
  
void ice_readDict(const Ice::InputStreamPtr&, Dict&);  
void ice_writeDict(const Ice::OutputStreamPtr&, const Dict&);  
  
void ice_readS(const Ice::InputStreamPtr&, S&);  
void ice_writeS(const Ice::OutputStreamPtr&, const S&);  
  
void ice_readE(const Ice::InputStreamPtr&, E&);  
void ice_writeE(const Ice::OutputStreamPtr&, E);  
  
void ice_readC(const Ice::InputStreamPtr&, CPtr&);  
void ice_writeC(const Ice::OutputStreamPtr&, const CPtr&);  
  
void ice_readCPrx(const Ice::InputStreamPtr&, CPrx&);  
void ice_writeCPrx(const Ice::OutputStreamPtr&, const CPrx&);  
}
```

In addition, the Slice compiler generates the following member functions for struct types:

```
struct S {  
    ...  
    void ice_read(const Ice::InputStreamPtr&);  
    void ice_write(const Ice::OutputStreamPtr&);  
};
```

Note that the compiler does not generate helper functions for sequences of primitive types because the stream classes already provide this functionality. Also be aware that a call to `ice_readC` does not result in the immediate extraction of an Ice object. The given reference to `CPtr` must remain valid until `readPendingObjects` is invoked on the input stream.

Intercepting Object Insertion and Extraction

In some situations it may be necessary to intercept the insertion and extraction of Ice objects. For example, the Ice extension for PHP (see Chapter 28) is implemented using Ice for C++ but represents Ice objects as native PHP objects. The PHP extension accomplishes this by manually encoding and decoding Ice objects as directed by Section 34.2. However, the extension obviously cannot pass a native PHP object to the C++ stream function `writeObject`. To bridge this gap between object systems, Ice supplies the classes `ObjectReader` and `ObjectWriter`:

```
namespace Ice {
    class ObjectReader : public Ice::Object {
    public:
        virtual void read(const InputStreamPtr&, bool) = 0;
        // ...
    };
    typedef ... ObjectReaderPtr;

    class ObjectWriter : public Ice::Object {
    public:
        virtual void write(const OutputStreamPtr&) const = 0;
        // ...
    };
    typedef ... ObjectWriterPtr;
}
```

A foreign Ice object is inserted into a stream using the following technique:

1. A C++ “wrapper” class is derived from `ObjectWriter`. This class wraps the foreign object and implements the `write` member function.
2. An instance of the wrapper class is passed to `writeObject`. (This is possible because `ObjectWriter` derives from `Ice::Object`.) Eventually, the `write` member function is invoked on the wrapper instance.
3. The implementation of `write` encodes the object’s state as directed by Section 34.2.11.

It is the application’s responsibility to ensure that there is a one-to-one mapping between foreign Ice objects and wrapper objects. This is necessary in order to ensure the proper encoding of object graphs.

Extracting the state of a foreign Ice object is more complicated than insertion:

1. A C++ “wrapper” class is derived from `ObjectReader`. An instance of this class represents a foreign Ice object.

2. An object factory is installed that returns instances of the wrapper class. Note that a single object factory can be used for all `Slice` types if it is registered with an empty `Slice` type id (see Section 6.14.5).
3. A C++ callback class is derived from `ReadObjectCallback`. The implementation of `invoke` expects its argument to be either `nil` or an instance of the wrapper class as returned by the object factory.
4. An instance of the callback class is passed to `readObject`.
5. When the stream is ready to extract the state of an object, it invokes `read` on the wrapper class. The implementation of `read` decodes the object's state as directed by Section 34.2.11. The boolean argument to `read` indicates whether the function should invoke `readTypeId` on the stream; it is possible that the type id of the current slice has already been read, in which case this argument is `false`.
6. The callback object passed to `readObject` is invoked, passing the instance of the wrapper object. All other callback objects representing the same instance in the stream (in case of object graphs) are invoked with the same wrapper object.

36.2.2 Java Stream Interface

We discuss the stream classes first, followed by the helper functions, and finish with an advanced use case of the streaming interface.

InputStream

An `InputStream` is created using the following function:

```
package Ice;

public class Util {
    public static InputStream
        createInputStream(Communicator communicator, byte[] data);
}
```

The `InputStream` interface is shown below.

```
package Ice;

public interface InputStream {
    Communicator communicator();

    void sliceObjects(boolean slice);
}
```

```
    boolean readBool();
    boolean[] readBoolSeq();

    byte readByte();
    byte[] readByteSeq();

    short readShort();
    short[] readShortSeq();

    int readInt();
    int[] readIntSeq();

    long readLong();
    long[] readLongSeq();

    float readFloat();
    float[] readFloatSeq();

    double readDouble();
    double[] readDoubleSeq();

    String readString();
    String[] readStringSeq();

    int readSize();

    ObjectPrx readProxy();

    void readObject(ReadObjectCallback cb);

    String readTypeId();

    void throwException() throws UserException;

    void startSlice();
    void endSlice();
    void skipSlice();

    void startEncapsulation();
    void endEncapsulation();

    void readPendingObjects();

    void destroy();
}
```

Member functions are provided for extracting all of the primitive types, as well as sequences of primitive types; these are self-explanatory. The remaining member functions have the following semantics:

- `void sliceObjects(boolean slice)`

Determines the behavior of the stream when extracting Ice objects. An Ice object is “sliced” when a factory cannot be found for a Slice type id (see Section 34.2.11 for more information), resulting in the creation of an object of a less-derived type. Slicing is typically disabled when the application expects all object factories to be present, in which case the exception `NoObjectFactoryException` is raised. The default behavior is to allow slicing.

- `int readSize()`

The Ice encoding has a compact representation to indicate size (see Section 34.2.1). This function extracts a size and returns it as an integer.

- `Ice.ObjectPrx readProxy()`

This function returns an instance of the base proxy type, `ObjectPrx`. The Slice compiler optionally generates helper functions to extract proxies of user-defined types (see page 1028).

- `void readObject(ReadObjectCallback cb)`

The Ice encoding for class instances requires extraction to occur in stages (see Section 34.2.11). The `readObject` function accepts a callback object of type `ReadObjectCallback`, whose definition is shown below:

```
package Ice;

public interface ReadObjectCallback {
    void invoke(Ice.Object obj);
}
```

When the object instance is available, the callback object's `invoke` member function is called. The application must call `readPendingObjects` to ensure that all instances are properly extracted.

Note that applications rarely need to invoke this member function directly; the helper functions generated by the Slice compiler are easier to use (see page 1037).

- `String readTypeId()`
A table of Slice type ids is used to save space when encoding Ice objects (see Section 34.2.11). This function returns the type id at the stream's current position.
- `void throwException()` throws `UserException`
This function extracts a user exception from the stream and throws it. If the stored exception is of an unknown type, the function attempts to extract and throw a less-derived exception. If that also fails, an `UnmarshalOutOfBoundsException` is thrown.
- `void startSlice()`
`void endSlice()`
`void skipSlice()`
Start, end, and skip a slice of member data, respectively. These functions are used when manually extracting the slices of an Ice object or user exception. See Section 34.2.11 for more information.
- `void startEncapsulation()`
`void endEncapsulation()`
Start and end an encapsulation, respectively. See Section 34.2.2 for more information.
- `void readPendingObjects()`
An application must call this function after all other data has been extracted, but only if Ice objects were encoded. This function extracts the state of Ice objects and invokes their corresponding callback objects (see `readObject`).
- `void destroy()`
Applications must call this function in order to reclaim resources.

Here is a simple example that demonstrates how to extract a boolean and a sequence of strings from a stream:

```
byte[] data = ...
Ice.InputStream in =
    Ice.Util.createInputStream(communicator, data);
try {
    boolean b = in.readBool();
    String[] seq = in.readStringSeq();
} finally {
    in.destroy();
}
```

OutputStream

An OutputStream is created using the following function:

```
package Ice;

public class Util {
    public static OutputStream createOutputStream(
        Communicator communicator);
}
```

The OutputStream class is shown below.

```
package Ice;

public interface OutputStream {
    Communicator communicator();

    void writeBool(boolean v);
    void writeBoolSeq(boolean[] v);

    void writeByte(byte v);
    void writeByteSeq(byte[] v);

    void writeShort(short v);
    void writeShortSeq(short[] v);

    void writeInt(int v);
    void writeIntSeq(int[] v);

    void writeLong(long v);
    void writeLongSeq(long[] v);

    void writeFloat(float v);
    void writeFloatSeq(float[] v);

    void writeDouble(double v);
    void writeDoubleSeq(double[] v);

    void writeString(String v);
    void writeStringSeq(String[] v);

    void writeSize(int sz);

    void writeProxy(ObjectPrx v);

    void writeObject(Ice.Object v);
```

```
void writeTypeId(String id);

void writeException(UserException ex);

void startSlice();
void endSlice();

void startEncapsulation();
void endEncapsulation();

void writePendingObjects();

byte[] finished();
void destroy();
}
```

Member functions are provided for inserting all of the primitive types, as well as sequences of primitive types; these are self-explanatory. The remaining member functions have the following semantics:

- `void writeSize(int sz)`
The Ice encoding has a compact representation to indicate size (see Section 34.2.1). This function converts the given integer into the proper encoded representation.
- `void writeObject(Ice.Object v)`
Inserts an Ice object. The Ice encoding for class instances (see Section 34.2.11) may cause the insertion of this object to be delayed, in which case the stream retains a reference to the given object and does not insert its state until `writePendingObjects` is invoked on the stream.
- `void writeTypeId(String id)`
A table of Slice type ids is used to save space when encoding Ice objects (see Section 34.2.11). This function adds the given id to the table and encodes the type id.
- `void writeException(UserException ex)`
Inserts a user exception.
- `void startSlice()`
`void endSlice()`
Starts and ends a slice of object or exception member data (see Section 34.2.11).

- `void startEncapsulation()`
`void endEncapsulation()`
Starts and ends an encapsulation, respectively (see Section 34.2.2).
- `void writePendingObjects()`
Encodes the state of Ice objects whose insertion was delayed during `writeObject`. This member function must only be called once.
- `byte[] finished()`
Indicates that marshaling is complete and returns the encoded byte sequence. This member function must only be called once.
- `void destroy()`
Applications must call this function in order to reclaim resources.

Here is a simple example that demonstrates how to insert a boolean and a sequence of strings into a stream:

```
final String[] seq = { "Ice", "rocks!" };
Ice.OutputStream out = Ice.Util.createOutputStream(communicator);
try {
    out.writeBool(true);
    out.writeStringSeq(seq);
    byte[] data = out.finished();
} finally {
    out.destroy();
}
```

Helper Functions

The stream classes provide all of the low-level functions necessary for encoding and decoding Ice types. However, it would be tedious and error-prone to manually encode complex Ice types such as classes, structs, and dictionaries using these low-level functions. For this reason, the Slice compiler (see Section 10.16) optionally generates helper functions for streaming complex Ice types.

We will use the following Slice definitions to demonstrate the language mapping:

```
module M {
    sequence<...> Seq;
    dictionary<...> Dict;
    struct S {
        ...
    };
    enum E { ... };
}
```

```

class C {
    ...
};

```

The Slice compiler generates the corresponding helper functions shown below:

```

package M;

public class SeqHelper {
    public static T[] read(Ice.InputStream in);
    public static void write(Ice.OutputStream out, T[] v);
}

public class DictHelper {
    public static java.util.Map read(Ice.InputStream in);
    public static void write(Ice.OutputStream out,
                             java.util.Map v);
}

public class SHelper {
    public static S read(Ice.InputStream in);
    public static void write(Ice.OutputStream out, S v);
}

public class EHelper {
    public static E read(Ice.InputStream in);
    public static void write(Ice.OutputStream out, E v);
}

public class CHelper {
    public static void read(Ice.InputStream in, CHolder h);
    public static void write(Ice.OutputStream out, C v);
}

public class CPrxHelper {
    public static CPrx read(Ice.InputStream in);
    public static void write(Ice.OutputStream out, CPrx v);
}

```

In addition, the Slice compiler generates the following member functions for struct and enum types:

```

public class S ... {
    ...
    public void ice_read(Ice.InputStream in);
    public void ice_write(Ice.OutputStream out);
}

```

```
};  
public class E... {  
    ...  
    public void ice_read(Ice.InputStream in);  
    public void ice_write(Ice.OutputStream out);  
}
```

Be aware that a call to `CHelper.read` does not result in the immediate extraction of an Ice object. The value member of the given `CHolder` object is updated when `readPendingObjects` is invoked on the input stream.

Intercepting Object Insertion and Extraction

In some situations it may be necessary to intercept the insertion and extraction of Ice objects. For example, the Ice extension for PHP (see Chapter 28) is implemented using Ice for C++ but represents Ice objects as native PHP objects. The PHP extension accomplishes this by manually encoding and decoding Ice objects as directed by Section 34.2. However, the extension obviously cannot pass a native PHP object to the C++ stream function `writeObject`. To bridge this gap between object systems, Ice supplies the classes `ObjectReader` and `ObjectWriter`:

```
package Ice;  
  
public abstract class ObjectReader extends ObjectImpl {  
    public abstract void read(InputStream in, boolean rid);  
    // ...  
}  
  
public abstract class ObjectWriter extends ObjectImpl {  
    public abstract void write(OutputStream out);  
    // ...  
}
```

A foreign Ice object is inserted into a stream using the following technique:

1. A Java “wrapper” class is derived from `ObjectWriter`. This class wraps the foreign object and implements the `write` member function.
2. An instance of the wrapper class is passed to `writeObject`. (This is possible because `ObjectWriter` derives from `Ice.Object`.) Eventually, the `write` member function is invoked on the wrapper instance.
3. The implementation of `write` encodes the object’s state as directed by Section 34.2.11.

It is the application's responsibility to ensure that there is a one-to-one mapping between foreign Ice objects and wrapper objects. This is necessary in order to ensure the proper encoding of object graphs.

Extracting the state of a foreign Ice object is more complicated than insertion:

1. A Java “wrapper” class is derived from `ObjectReader`. An instance of this class represents a foreign Ice object.
2. An object factory is installed that returns instances of the wrapper class. Note that a single object factory can be used for all Slice types if it is registered with an empty Slice type id (see Section 10.14.4).
3. A Java callback class implements the `ReadObjectCallback` interface. The implementation of `invoke` expects its argument to be either null or an instance of the wrapper class as returned by the object factory.
4. An instance of the callback class is passed to `readObject`.
5. When the stream is ready to extract the state of an object, it invokes `read` on the wrapper class. The implementation of `read` decodes the object's state as directed by Section 34.2.11. The boolean argument to `read` indicates whether the function should invoke `readTypeId` on the stream; it is possible that the type id of the current slice has already been read, in which case this argument is `false`.
6. The callback object passed to `readObject` is invoked, passing the instance of the wrapper object. All other callback objects representing the same instance in the stream (in case of object graphs) are invoked with the same wrapper object.

36.2.3 C# Stream Interface

We discuss the stream classes first, followed by the helper functions, and finish with an advanced use case of the streaming interface.

InputStream

An `InputStream` is created using the following function:

```
namespace Ice
{
    public sealed class Util
    {
        public static InputStream createInputStream(
```

```
        Communicator communicator,  
        byte[] bytes);  
    }  
}
```

The `InputStream` interface is shown below.

```
namespace Ice  
{  
    public interface InputStream  
    {  
        Communicator communicator();  
  
        void sliceObjects(bool slice);  
  
        bool readBool();  
        bool[] readBoolSeq();  
  
        byte readByte();  
        byte[] readByteSeq();  
  
        short readShort();  
        short[] readShortSeq();  
  
        int readInt();  
        int[] readIntSeq();  
  
        long readLong();  
        long[] readLongSeq();  
  
        float readFloat();  
        float[] readFloatSeq();  
  
        double readDouble();  
        double[] readDoubleSeq();  
  
        string readString();  
        string[] readStringSeq();  
  
        int readSize();  
  
        ObjectPrx readProxy();  
  
        void readObject(ReadObjectCallback cb);  
  
        string readTypeId();  
    }  
}
```

```

        void throwException();

        void startSlice();
        void endSlice();
        void skipSlice();

        void startEncapsulation();
        void endEncapsulation();

        void readPendingObjects();

        void destroy();
    }
}

```

Member functions are provided for extracting all of the primitive types, as well as sequences of primitive types; these are self-explanatory. The remaining member functions have the following semantics:

- `void sliceObjects(boolean slice)`
 Determines the behavior of the stream when extracting Ice objects. An Ice object is “sliced” when a factory cannot be found for a Slice type id (see Section 34.2.11 for more information), resulting in the creation of an object of a less-derived type. Slicing is typically disabled when the application expects all object factories to be present, in which case the exception `NoObjectFactoryException` is raised. The default behavior is to allow slicing.
- `int readSize()`
 The Ice encoding has a compact representation to indicate size (see Section 34.2.1). This function extracts a size and returns it as an integer.
- `Ice.ObjectPrx readProxy()`
 This function returns an instance of the base proxy type, `ObjectPrx`. The Slice compiler optionally generates helper functions to extract proxies of user-defined types (see page 1047).
- `void readObject(ReadObjectCallback cb)`
 The Ice encoding for class instances requires extraction to occur in stages (see Section 34.2.11). The `readObject` function accepts a callback object of type `ReadObjectCallback`, whose definition is shown below:

```
namespace Ice
```



```
{
    public interface ReadObjectCallback
    {
        void invoke(Ice.Object obj);
    }
}
```

When the object instance is available, the callback object's `invoke` member function is called. The application must call `readPendingObjects` to ensure that all instances are properly extracted.

Note that applications rarely need to invoke this member function directly; the helper functions generated by the Slice compiler are easier to use (see page 1047).

- `string readTypeId()`

A table of Slice type ids is used to save space when encoding Ice objects (see Section 34.2.11). This function returns the type id at the stream's current position.

- `void throwException()`

This function extracts a user exception from the stream and throws it. If the stored exception is of an unknown type, the function attempts to extract and throw a less-derived exception. If that also fails, an `UnmarshalOutOfBoundsException` is thrown.

- `void startSlice()`
`void endSlice()`
`void skipSlice()`

Start, end, and skip a slice of member data, respectively. These functions are used when manually extracting the slices of an Ice object or user exception. See Section 34.2.11 for more information.

- `void startEncapsulation()`
`void endEncapsulation()`

Start and end an encapsulation, respectively. See Section 34.2.2 for more information.

- `void readPendingObjects()`

An application must call this function after all other data has been extracted, but only if Ice objects were encoded. This function extracts the state of Ice objects and invokes their corresponding callback objects (see `readObject`).

- `void destroy()`

Applications must call this function in order to reclaim resources.

Here is a simple example that demonstrates how to extract a boolean and a sequence of strings from a stream:

```
byte[] data = ...
Ice.InputStream inStream =
    Ice.Util.createInputStream(communicator, data);
try {
    bool b = inStream.readBool();
    string[] seq = inStream.readStringSeq();
} finally {
    inStream.destroy();
}
```

OutputStream

An `OutputStream` is created using the following function:

```
namespace Ice
{
    public sealed class Util
    {
        public static OutputStream createOutputStream(
            Communicator communicator);
    }
}
```

The `OutputStream` class is shown below.

```
namespace Ice
{
    public interface OutputStream
    {
        Communicator communicator();

        void writeBool(bool v);
        void writeBoolSeq(bool[] v);

        void writeByte(byte v);
        void writeByteSeq(byte[] v);

        void writeShort(short v);
        void writeShortSeq(short[] v);

        void writeInt(int v);
    }
}
```

```
void writeIntSeq(int[] v);

void writeLong(long v);
void writeLongSeq(long[] v);

void writeFloat(float v);
void writeFloatSeq(float[] v);

void writeDouble(double v);
void writeDoubleSeq(double[] v);

void writeString(string v);
void writeStringSeq(string[] v);

void writeSize(int sz);

void writeProxy(ObjectPrx v);

void writeObject(Ice.Object v);

void writeTypeId(string id);

void writeException(UserException ex);

void startSlice();
void endSlice();

void startEncapsulation();
void endEncapsulation();

void writePendingObjects();

byte[] finished();
void destroy();
}
}
```

Member functions are provided for inserting all of the primitive types, as well as sequences of primitive types; these are self-explanatory. The remaining member functions have the following semantics:

- `void writeSize(int sz)`

The Ice encoding has a compact representation to indicate size (see Section 34.2.1). This function converts the given integer into the proper encoded representation.

- `void writeObject(Ice.Object v)`
Inserts an Ice object. The Ice encoding for class instances (see Section 34.2.11) may cause the insertion of this object to be delayed, in which case the stream retains a reference to the given object and does not insert its state until `writePendingObjects` is invoked on the stream.
- `void writeTypeId(string id)`
A table of Slice type ids is used to save space when encoding Ice objects (see Section 34.2.11). This function adds the given type id to the table and encodes the type id.
- `void writeException(UserException ex)`
Inserts a user exception.
- `void startSlice()`
`void endSlice()`
Starts and ends a slice of object or exception member data (see Section 34.2.11).
- `void startEncapsulation()`
`void endEncapsulation()`
Starts and ends an encapsulation, respectively (see Section 34.2.2).
- `void writePendingObjects()`
Encodes the state of Ice objects whose insertion was delayed during `writeObject`. This member function must only be called once.
- `byte[] finished()`
Indicates that marshaling is complete and returns the encoded byte sequence. This member function must only be called once.
- `void destroy()`
Applications must call this function in order to reclaim resources.

Here is a simple example that demonstrates how to insert a boolean and a sequence of strings into a stream:

```
string[] seq = { "Ice", "rocks!" };  
Ice.OutputStream outputStream  
    = Ice.Util.createOutputStream(communicator);  
try {  
    outputStream.writeBool(true);  
    outputStream.writeStringSeq(seq);  
}
```

```

    byte[] data = outputStream.finished();
} finally {
    outputStream.destroy();
}

```

Helper Functions

The stream classes provide all of the low-level functions necessary for encoding and decoding Ice types. However, it would be tedious and error-prone to manually encode complex Ice types such as classes, structs, and dictionaries using these low-level functions. For this reason, the Slice compiler (see Section 14.16) optionally generates helper functions for streaming complex Ice types.

We will use the following Slice definitions to demonstrate the language mapping:

```

module M {
    sequence<...> Seq;
    dictionary<...> Dict;
    struct S {
        ...
    };
    enum E { ... };
    class C {
        ...
    };
};

```

The Slice compiler generates the corresponding helper functions shown below:

```

namespace M
{
    public sealed class SeqHelper
    {
        public static int[] read(Ice.InputStream _in);
        public static void write(Ice.OutputStream _out, int[] _v);
    }

    public sealed class DictHelper
    {
        public static Dict read(Ice.InputStream _in);
        public static void write(Ice.OutputStream _out, Dict _v);
    }

    public sealed class SHelper
    {
        public static S read(Ice.InputStream _in);
    }
}

```

```

        public static void write(Ice.OutputStream _out, S _v);
    }

    public sealed class EHelper
    {
        public static M.E read(Ice.InputStream _in);
        public static void write(Ice.OutputStream _out, M.E _v);
    }

    public sealed class CHelper
    {
        public CHelper(Ice.InputStream _in);
        public void read();
        public static void write(Ice.OutputStream _out, C _v);
        public M.C value
        {
            get;
        }
        // ...
    }

    public sealed class CPrxHelper : Ice.ObjectPrxHelperBase, CPrx
    {
        public static CPrx read(Ice.InputStream _in);
        public static void write(Ice.OutputStream _out, CPrx _v);
    }
}

```

In addition, the Slice compiler generates the following member functions for struct types:

```

public struct S {
    ...
    public void ice_read(Ice.InputStream in);
    public void ice_write(Ice.OutputStream out);
}

```

Be aware that a call to `CHelper.read` does not result in the immediate extraction of an Ice object. The value property of the given `CHelper` object is updated when `readPendingObjects` is invoked on the input stream.

Intercepting Object Insertion and Extraction

In some situations it may be necessary to intercept the insertion and extraction of Ice objects. For example, the Ice extension for PHP (see Chapter 28) is implemented using Ice for C++ but represents Ice objects as native PHP objects. The

PHP extension accomplishes this by manually encoding and decoding Ice objects as directed by Section 34.2. However, the extension obviously cannot pass a native PHP object to the C++ stream function `writeObject`. To bridge this gap between object systems, Ice supplies the classes `ObjectReader` and `ObjectWriter`:

```
namespace Ice
{
    public abstract class ObjectReader : ObjectImpl
    {
        public abstract void read(InputStream inStream, bool rid);
        // ...
    }

    public abstract class ObjectWriter : ObjectImpl
    {
        public abstract void write(OutputStream outStream);
        // ...
    }
}
```

A foreign Ice object is inserted into a stream using the following technique:

1. A C# “wrapper” class is derived from `ObjectWriter`. This class wraps the foreign object and implements the `write` member function.
2. An instance of the wrapper class is passed to `writeObject`. (This is possible because `ObjectWriter` derives from `Ice.Object`.) Eventually, the `write` member function is invoked on the wrapper instance.
3. The implementation of `write` encodes the object’s state as directed by Section 34.2.11.

It is the application’s responsibility to ensure that there is a one-to-one mapping between foreign Ice objects and wrapper objects. This is necessary in order to ensure the proper encoding of object graphs.

Extracting the state of a foreign Ice object is more complicated than insertion:

1. A C# “wrapper” class is derived from `ObjectReader`. An instance of this class represents a foreign Ice object.
2. An object factory is installed that returns instances of the wrapper class. Note that a single object factory can be used for all Slice types if it is registered with an empty Slice type id (see Section 10.14.4).

3. A C# callback class implements the `ReadObjectCallback` interface. The implementation of `invoke` expects its argument to be either null or an instance of the wrapper class as returned by the object factory.
4. An instance of the callback class is passed to `readObject`.
5. When the stream is ready to extract the state of an object, it invokes `read` on the wrapper class. The implementation of `read` decodes the object's state as directed by Section 34.2.11. The boolean argument to `read` indicates whether the function should invoke `readTypeId` on the stream; it is possible that the type id of the current slice has already been read, in which case this argument is `false`.
6. The callback object passed to `readObject` is invoked, passing the instance of the wrapper object. All other callback objects representing the same instance in the stream (in case of object graphs) are invoked with the same wrapper object.

36.2.4 Visual Basic Stream Interface

We discuss the stream classes first, followed by the helper functions, and finish with an advanced use case of the streaming interface.

InputStream

An `InputStream` is created using the following function:

```
Namespace Ice

    Public NotInheritable Class Util
        Public Shared Function createInputStream( _
            ByVal communicator As Ice.Communicator, _
            ByVal bytes As Byte()) As Ice.InputStream
    End Class

End Namespace
```

The `InputStream` interface is shown below.

```
Namespace Ice
    Public Interface InputStream
        Function communicator() As Communicator

        Sub sliceObjects(ByVal slice As Boolean)

        Function readBool() As Boolean
    End Interface
End Namespace
```



```
Function readBoolSeq As Boolean()

Function readByte As Byte
Function readByteSeq As Byte()

Function readShort As Short
Function readShortSeq As Short()

Function readInt As Integer
Function readIntSeq As Integer()

Function readLong As Long
Function readLongSeq As Long()

Function readFloat As Single
Function readFloatSeq As Single()

Function readDouble As Double
Function readDoubleSeq As Double()

Function readString As String
Function readStringSeq As String()

Function readSize As Integer

Function readProxy As ObjectPrx

Function readObject(ByVal cb As ReadObjectCallback)

Function readTypeId()

Sub throwException()

Sub startSlice()
Sub endSlice()
Sub skipSlice()

Sub startEncapsulation()
Sub endEncapsulation()

Sub readPendingObject()

Sub destroy()
End Interface
End Namespace
```

Member functions are provided for extracting all of the primitive types, as well as sequences of primitive types; these are self-explanatory. The remaining member functions have the following semantics:

- Sub `sliceObjects(ByVal slice As Boolean)`
Determines the behavior of the stream when extracting Ice objects. An Ice object is “sliced” when a factory cannot be found for a Slice type id (see Section 34.2.11 for more information), resulting in the creation of an object of a less-derived type. Slicing is typically disabled when the application expects all object factories to be present, in which case the exception `NoObjectFactoryException` is raised. The default behavior is to allow slicing.
- Function `readSize() As Integer`
The Ice encoding has a compact representation to indicate size (see Section 34.2.1). This function extracts a size and returns it as an integer.
- Function `readProxy() As Ice.ObjectPrx`
This function returns an instance of the base proxy type, `ObjectPrx`. The Slice compiler optionally generates helper functions to extract proxies of user-defined types (see page 1056).
- Sub `readObject(ByVal cb As ReadObjectCallback)`
The Ice encoding for class instances requires extraction to occur in stages (see Section 34.2.11). The `readObject` procedure accepts a callback object of type `ReadObjectCallback`, whose definition is shown below:

```
Namespace Ice

    Public Interface ReadObjectCallback
        Sub invoke(ByVal obj As Ice.Object)
    End Interface

End Namespace
```

When the object instance is available, the callback object's `invoke` member function is called. The application must call `readPendingObjects` to ensure that all instances are properly extracted.

Note that applications rarely need to invoke this member function directly; the helper functions generated by the Slice compiler are easier to use (see page 1056).

- Function `readTypeId() As String`
A table of Slice type ids is used to save space when encoding Ice objects (see Section 34.2.11). This function returns the type id at the stream's current position.
- Sub `throwException()`
This procedure extracts a user exception from the stream and throws it. If the stored exception is of an unknown type, the function attempts to extract and throw a less-derived exception. If that also fails, an `UnmarshalOutOfBoundsException` is thrown.
- Sub `startSlice()`
Sub `endSlice()`
Sub `skipSlice()`
Start, end, and skip a slice of member data, respectively. These procedures are used when manually extracting the slices of an Ice object or user exception. See Section 34.2.11 for more information.
- Sub `startEncapsulation()`
Sub `endEncapsulation()`
Start and end an encapsulation, respectively. See Section 34.2.2 for more information.
- Sub `readPendingObjects()`
An application must call this procedure after all other data has been extracted, but only if Ice objects were encoded. This function extracts the state of Ice objects and invokes their corresponding callback objects (see `readObject`).
- Sub `destroy()`
Applications must call this procedure in order to reclaim resources.

Here is a simple example that demonstrates how to extract a boolean and a sequence of strings from a stream:

```
Dim data As Byte() = ...
Dim inStream As Ice.InputStream =
    Ice.Util.createInputStream(communicator, data)
Try
    Dim b As Boolean = inStream.readBool()
    Dim seq As String() = inStream.readStringSeq()
Catch ex As Exception
    inStream.destroy()
End Try
```

OutputStream

An OutputStream is created using the following function:

```
Namespace Ice
```

```
    Public NotInheritable Class Util
        Public Shared Function createOutputStream( _
            ByVal communicator As Ice.Communicator) _
            As Ice.OutputStream
```

```
    End Class
```

```
End Namespace
```

The OutputStream class is shown below.

```
Namespace Ice
```

```
    Public Interface OutputStream
        Function communicator() As Communicator

        Sub writeBool(ByVal v As Boolean)
        Sub writeBoolSeq(VyVal v As Boolean())

        Sub writeByte(ByVal v As Byte)
        Sub writeByteSeq(ByVal v As Byte())

        Sub writeShort(ByVal v As Short)
        Sub writeShortSeq(ByVal v As Short())

        Sub writeInt(ByVal v As Integer)
        Sub writeIntSeq(ByVal v As Integer())

        Sub writeLong(ByVal v As Long)
        Sub writeLongSeq(ByVal v As Long())

        Sub writeFloat(ByVal v As Single)
        Sub writeFloatSeq(ByVal v As Single())

        Sub writeDouble(ByVal v As Double)
        Sub writeDoubleSeq(ByVal v As Double())

        Sub writeString(ByVal v As String)
        Sub writeStringSeq(ByVal v As String())

        Sub writeSize(ByVal sz As Integer)
```

```
Sub writeProxy(ByVal v As ObjectPrx)

Sub writeObject(ByVal v As Ice.Object)

Sub writeTypeId(ByVal id As String)

Sub writeException(ByVal ex As UserException)

Sub startSlice()
Sub endSlice()

Sub startEncapsulation()
Sub endEncapsulation()

Sub writePendingObjects()

Function finished() As Byte()
Sub destroy()
End Interface
```

End Namespace

Member functions are provided for inserting all of the primitive types, as well as sequences of primitive types; these are self-explanatory. The remaining member functions have the following semantics:

- `Sub writeSize(ByVal sz As Integer)`
The Ice encoding has a compact representation to indicate size (see Section 34.2.1). This function converts the given integer into the proper encoded representation.
- `Sub writeObject(ByVal v As Ice.Object)`
Inserts an Ice object. The Ice encoding for class instances (see Section 34.2.11) may cause the insertion of this object to be delayed, in which case the stream retains a reference to the given object and does not insert its state until `writePendingObjects` is invoked on the stream.
- `Sub writeTypeId(ByVal id As String)`
A table of Slice type ids is used to save space when encoding Ice objects (see Section 34.2.11). This function adds the given type id to the table and encodes the type id.
- `Sub writeException(ByVal ex As UserException)`
Inserts a user exception.

- Sub startSlice()
Sub endSlice()
Starts and ends a slice of object or exception member data (see Section 34.2.11).
- Sub startEncapsulation()
Sub endEncapsulation()
Starts and ends an encapsulation, respectively (see Section 34.2.2).
- Sub writePendingObjects()
Encodes the state of Ice objects whose insertion was delayed during writeObject. This member function must only be called once.
- Function finished() As Byte()
Indicates that marshaling is complete and returns the encoded byte sequence. This member function must only be called once.
- Sub destroy()
Applications must call this function in order to reclaim resources.

Here is a simple example that demonstrates how to insert a boolean and a sequence of strings into a stream:

```
Dim seq As String() = ("Ice", "rocks!")
Dim outputStream As Ice.OutputStream
    = Ice.Util.createOutputStream(communicator)
Try
    outputStream.writeBool(True)
    outputStream.writeStringSeq(seq)
    Dim data As Byte() = outputStream.finished()
Catch ex As Exception
    outputStream.destroy()
End Try
```

Helper Functions

The stream classes provide all of the low-level functions necessary for encoding and decoding Ice types. However, it would be tedious and error-prone to manually encode complex Ice types such as classes, structs, and dictionaries using these low-level functions. For this reason, the Slice compiler (see Section 18.16) optionally generates helper functions for streaming complex Ice types.

We will use the following Slice definitions to demonstrate the language mapping:

```

module M {
    sequence<...> Seq;
    dictionary<...> Dict;
    struct S {
        ...
    };
    enum E { ... };
    class C {
        ...
    };
};

```

The Slice compiler generates the corresponding helper functions shown below:

Namespace M

```

Public NotInheritable Class SeqHelper
    Public Shared Function read( _
        ByVal __in As Ice.InputStream) _
        As Integer()
    Public Shared Sub write( _
        ByVal __out As Ice.OutputStream, _
        ByVal __v As Integer())
End Class

Public NotInheritable Class DictHelper
    Public Shared Function read( _
        ByVal __in As Ice.InputStream) As Dict
    Public Shared Sub write( _
        ByVal __out As Ice.OutputStream, _
        ByVal __v As Dict)
End Class

Public NotInheritable Class SHelper
    Public Shared Function read( _
        ByVal __in As Ice.InputStream) As S
    Public Shared Sub write( _
        ByVal __out As Ice.OutputStream, _
        ByVal __v As S)
End Class

Public NotInheritable Class EHelper
    Public Shared Function read( _
        ByVal __in As Ice.InputStream) As M.E
    Public Shared Sub write( _
        ByVal __out As Ice.OutputStream, _

```

```

        ByVal __v As M.E)
End Class

Public NotInheritable Class CHelper
    Public Sub New(ByVal __in As Ice.InputStream)

    Public Sub read()
    Public Shared Sub write( _
        ByVal __out As Ice.OutputStream, _
        ByVal __v As C)

    Public ReadOnly Property value() As M.C
End Class

Public NotInheritable Class CPrxHelper
    Inherits Ice.ObjectPrxHelperBase
    Implements CPrx

    Public Shared Function read( _
        ByVal __in As Ice.InputStream) As CPrx
    Public Shared Sub write( _
        ByVal __out As Ice.OutputStream, _
        ByVal __v As CPrx)

End Class

End Namespace

```

In addition, the Slice compiler generates the following member functions for struct types:

```

Public Structure S {
    ...
    Public Sub ice_read(ByVal in as Ice.InputStream);
    Public Sub ice_write(ByVal out as Ice.OutputStream);
}

```

Be aware that a call to `CHelper.read` does not result in the immediate extraction of an Ice object. The value property of the given `CHelper` object is updated when `readPendingObjects` is invoked on the input stream.

Intercepting Object Insertion and Extraction

In some situations it may be necessary to intercept the insertion and extraction of Ice objects. For example, the Ice extension for PHP (see Chapter 28) is implemented using Ice for C++ but represents Ice objects as native PHP objects. The PHP extension accomplishes this by manually encoding and decoding Ice objects

as directed by Section 34.2. However, the extension obviously cannot pass a native PHP object to the C++ stream function `writeObject`. To bridge this gap between object systems, Ice supplies the classes `ObjectReader` and `ObjectWriter`:

```

Namespace Ice

    Public MustInherit Class ObjectReader
        Inherits ObjectImpl
        Public MustOverride Sub read( _
            ByVal inStream As InputStream, _
            ByVal rid As Boolean)
        ' ...
    End Class

    public MustInherit Class ObjectWriter
        Inherits ObjectImpl
        Public MustOverride Sub write( _
            ByVal outStream As OutputStream)
        ' ...
    End Class

End Namespace

```

A foreign Ice object is inserted into a stream using the following technique:

1. A VB “wrapper” class is derived from `ObjectWriter`. This class wraps the foreign object and implements the `write` member function.
2. An instance of the wrapper class is passed to `writeObject`. (This is possible because `ObjectWriter` derives from `Ice.Object`.) Eventually, the `write` member function is invoked on the wrapper instance.
3. The implementation of `write` encodes the object’s state as directed by Section 34.2.11.

It is the application’s responsibility to ensure that there is a one-to-one mapping between foreign Ice objects and wrapper objects. This is necessary in order to ensure the proper encoding of object graphs.

Extracting the state of a foreign Ice object is more complicated than insertion:

1. A VB “wrapper” class is derived from `ObjectReader`. An instance of this class represents a foreign Ice object.
2. An object factory is installed that returns instances of the wrapper class. Note that a single object factory can be used for all `Slice` types if it is registered with an empty `Slice` type id (see Section 10.14.4).

3. A VB callback class implements the `ReadObjectCallback` interface. The implementation of `invoke` expects its argument to be either null or an instance of the wrapper class as returned by the object factory.
4. An instance of the callback class is passed to `readObject`.
5. When the stream is ready to extract the state of an object, it invokes `read` on the wrapper class. The implementation of `read` decodes the object's state as directed by Section 34.2.11. The boolean argument to `read` indicates whether the function should invoke `readTypeId` on the stream; it is possible that the type id of the current slice has already been read, in which case this argument is `false`.
6. The callback object passed to `readObject` is invoked, passing the instance of the wrapper object. All other callback objects representing the same instance in the stream (in case of object graphs) are invoked with the same wrapper object.

36.3 Dynamic Invocation and Dispatch

Ice applications generally use the static invocation model, in which the application invokes a Slice operation by calling a member function on a generated proxy class. In the server, the static dispatch model behaves similarly: the request is dispatched to the servant as a statically-typed call to a member function. Underneath this statically-typed facade, the Ice run times in the client and server are

exchanging sequences of bytes representing the encoded request arguments and results. These interactions are illustrated in Figure 36.1.

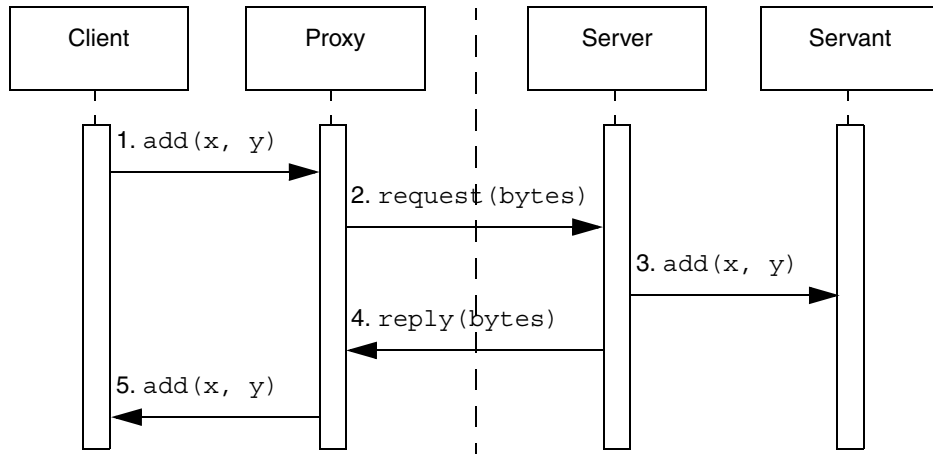

Figure 36.1. Interactions in a static invocation.

1. The client initiates a call to the Slice operation `add` by calling the member function `add` on a proxy.
2. The generated proxy class marshals the arguments into a sequence of bytes and transmits them to the server.
3. In the server, the generated servant class unmarshals the arguments and calls `add` on the subclass.
4. The servant marshals the results and returns them to the client.
5. Finally, the client's proxy unmarshals the results and returns them to the caller.

The application is blissfully unaware of this low-level machinery, and in the majority of cases that is a distinct advantage. In some situations, however, an application can leverage this machinery to accomplish tasks that are not possible in a statically-typed environment. Ice provides the dynamic invocation and dispatch models for these situations, allowing applications to send and receive requests as encoded sequences of bytes instead of statically-typed arguments.

The dynamic invocation and dispatch models offer several unique advantages to Ice services that forward requests from senders to receivers, such as Glacier2 (Chapter 41) and IceStorm (Chapter 43). For these services, the request arguments are an opaque byte sequence that can be forwarded without the need to unmarshal

and remarshal the arguments. Not only is this significantly more efficient than a statically-typed implementation, it also allows intermediaries such as Glacier2 and IceStorm to be ignorant of the Slice types in use by senders and receivers.

Another use case for the dynamic invocation and dispatch models is scripting language integration. The Ice extensions for Python, PHP, and Ruby invoke Slice operations using the dynamic invocation model; the request arguments are encoded using the streaming interfaces from Section 36.2.

It may be difficult to resist the temptation of using a feature like dynamic invocation or dispatch, but we recommend that you carefully consider the risks and complexities of such a decision. For example, an application that uses the streaming interface to manually encode and decode request arguments has a high risk of failure if the argument signature of an operation changes. In contrast, this risk is greatly reduced in the static invocation and dispatch models because errors in a strongly-typed language are found early, during compilation. Therefore, we caution you against using this capability except where its advantages significantly outweigh the risks.

36.3.1 Dynamic Invocation using `ice_invoke`

Dynamic invocation is performed using the proxy member function `ice_invoke`, defined in the proxy base class `ObjectPrx`. If we were to define the function in Slice, it would look like this:

```
sequence<byte> ByteSeq;

bool ice_invoke(
    string operation,
    Ice::OperationMode mode,
    ByteSeq inParams,
    out ByteSeq outParams
);
```

The first argument is the name of the Slice operation². The second argument is an enumerator from the Slice type `Ice::OperationMode`; the possible values are `Normal`, `Nonmutating` and `Idempotent`. The third argument, `inParams`, represents the encoded in parameters of the operation.

2. This is the Slice name of the operation, not the name as it might be mapped to any particular language. For example, the string "while" is the name of the Slice operation `while`, and not `"_cpp_while"` (C++) or `"_while"` (Java).

A return value of `true` indicates a successful invocation, in which case the marshaled form of the operation's results (if any) is provided in `outParams`. A return value of `false` signals the occurrence of a user exception whose marshaled form is provided in `outParams`. The caller must also be prepared to catch local exceptions, which are thrown directly.

36.3.2 Dynamic Dispatch using `Blobject`

A server enables dynamic dispatch by creating a subclass of `Blobject` (the name is derived from *blob*, meaning a blob of bytes). The Slice equivalent of `Blobject` is shown below:

```
sequence<byte> ByteSeq;

interface Blobject {
    bool ice_invoke(ByteSeq inParams, out ByteSeq outParams);
};
```

The `inParams` argument supplies the encoded in parameters. The contents of the `outParams` argument depends on the outcome of the invocation: if the operation succeeded, `ice_invoke` must return `true` and place the encoded results in `outParams`; if a user exception occurred, `ice_invoke` must return `false`, in which case `outParams` contains the encoded exception. The operation may also raise local exceptions such as `OperationNotExistException`.

The language mappings add a trailing argument of type `Ice::Current` to `ice_invoke`, and this provides the implementation with the name of the operation being dispatched. See Section 31.6 for more information on `Ice::Current`.

Because `Blobject` derives from `Object`, an instance is a regular `Ice` object just like instances of the classes generated for user-defined Slice interfaces. The primary difference is that all operation invocations on a `Blobject` instance are dispatched through the `ice_invoke` member function.

If a `Blobject` subclass intends to decode the in parameters (and not simply forward the request to another object), then the implementation obviously must know the signatures of all operations it supports. For example, the Ice extension for PHP (see Chapter 28) uses the Slice parser library to parse Slice files at run time; the Slice description of the operation drives the decoding process. How a `Blobject` subclass determines its type information is an implementation detail that is beyond the scope of this book.

36.3.3 C++ Mapping

This section describes the C++ mapping for the `ice_invoke` proxy function and the `Blobject` class.

`ice_invoke`

The mapping for `ice_invoke` is shown below:

```
bool ice_invoke(
    const std::string& operation,
    Ice::OperationMode mode,
    const std::vector< Ice::Byte >& inParams,
    std::vector< Ice::Byte >& outParams
);
```

Another overloading of `ice_invoke` (not shown) adds a trailing argument of type `Ice::Context` (see Section 31.11).

As an example, the code below demonstrates how to invoke the operation `op`, which takes no in parameters:

```
Ice::ObjectPrx proxy = ...
try {
    std::vector<Ice::Byte> inParams, outParams;
    if (proxy->ice_invoke("op", Ice::Normal, inParams,
                        outParams)) {
        // Handle success
    } else {
        // Handle user exception
    }
} catch (const Ice::LocalException& ex) {
    // Handle exception
}
```

Using Streams with `ice_invoke`

The streaming interface described in Section 36.2 provides the tools an application needs to dynamically invoke operations with arguments of any Slice type. Consider the following Slice definition:

```
module Calc {
    exception Overflow {
        int x;
        int y;
    };
    interface Compute {
```

```

        nonmutating int add(int x, int y)
            throws Overflow;
    };
};

```

Now let's write a client that dynamically invokes the add operation:

```

Ice::ObjectPrx proxy = ...
try {
    std::vector< Ice::Byte > inParams, outParams;

    Ice::OutputStreamPtr out =
        Ice::createOutputStream(communicator);
    out->writeInt(100); // x
    out->writeInt(-1); // y
    out->finished(inParams);

    if (proxy->ice_invoke("add", Ice::Nonmutating, inParams,
                        outParams)) {
        // Handle success
        Ice::InputStreamPtr in =
            Ice::createInputStream(communicator, outParams);
        int result = in->readInt();
        assert(result == 99);
    } else {
        // Handle user exception
    }
} catch (const Ice::LocalException& ex) {
    // Handle exception
}

```

We neglected to handle the case of a user exception in this example, so let's implement that now. We assume that we have compiled our program with the Slice-generated code, therefore we can call `throwException` on the input stream and catch `Overflow` directly³:

```

    if (proxy->ice_invoke("add", Ice::Nonmutating, inParams,
                        outParams)) {
        // Handle success
        // ...
    } else {

```

3. This is obviously a contrived example: if the Slice-generated code is available, why bother using dynamic dispatch? In the absence of Slice-generated code, the caller would need to manually unmarshal the user exception, which is outside the scope of this book.

```

    // Handle user exception
    Ice::InputStreamPtr in =
        Ice::createInputStream(communicator, outParams);
    try {
        in->throwException();
    } catch (const Calc::Overflow& ex) {
        cout << "overflow while adding " << ex.x
            << " and " << ex.y << endl;
    } catch (const Ice::UserException& ex) {
        // Handle unexpected user exception
    }
}

```

As a defensive measure, the code traps `Ice::UserException`. This could be raised if the Slice definition of `add` is modified to include another user exception but this segment of code did not get updated accordingly.

Subclassing `Blobject`

Implementing the dynamic dispatch model requires writing a subclass of `Ice::Blobject`. We continue using the `Compute` interface from page 1064 to demonstrate a `Blobject` implementation:

```

class ComputeI : public Ice::Blobject {
public:
    virtual bool ice_invoke(
        const std::vector<Ice::Byte>& inParams,
        std::vector<Ice::Byte>& outParams,
        const Ice::Current& current);
};

```

An instance of `ComputeI` is an `Ice` object because `Blobject` derives from `Object`, therefore an instance can be added to an object adapter like any other servant (see Chapter 31 for more information on object adapters).

For the purposes of this discussion, the implementation of `ice_invoke` handles only the `add` operation and raises `OperationNotExistException` for all other operations. In a real implementation, the servant must also be prepared to receive invocations of the following operations:

- `string ice_id()`
Returns the Slice type id of the servant's most-derived type.
- `StringSeq ice_ids()`
Returns a sequence of strings representing all of the Slice interfaces supported by the servant, including `"::Ice::Object"`.

- `bool ice_isA(string id)`
Returns `true` if the servant supports the interface denoted by the given Slice type `id`, or `false` otherwise. This operation is invoked by the proxy function `checkedCast`.
- `void ice_ping()`
Verifies that the object denoted by the identity and facet contained in `Ice::Current` is reachable.

With that in mind, here is our simplified version of `ice_invoke`:

```
bool ComputeI::ice_invoke(
    const std::vector<Ice::Byte>& inParams,
    std::vector<Ice::Byte>& outParams,
    const Ice::Current& current)
{
    if (current.operation == "add") {
        Ice::CommunicatorPtr communicator =
            current.adapter->getCommunicator();
        Ice::InputStreamPtr in =
            Ice::createInputStream(communicator, inParams);
        int x = in->readInt();
        int y = in->readInt();
        Ice::OutputStreamPtr out =
            Ice::createOutputStream(communicator);
        if (checkOverflow(x, y)) {
            Calc::Overflow ex;
            ex.x = x;
            ex.y = y;
            out->writeException(ex);
            out->finished(outParams);
            return false;
        } else {
            out->writeInt(x + y);
            out->finished(outParams);
            return true;
        }
    } else {
        Ice::OperationNotExistException ex(__FILE__, __LINE__);
        ex.id = current.id;
        ex.facet = current.facet;
        ex.operation = current.operation;
        throw ex;
    }
}
```

If an overflow is detected, the code “raises” the `Calc::Overflow` user exception by calling `writeException` on the output stream and returning `false`, otherwise the return value is encoded and the function returns `true`.

Array Mapping

Ice for C++ supports an alternative mapping for sequence input parameters that avoids the overhead of extra copying. Since the `ice_invoke` functions treat the encoded input parameters as a value of type `sequence<byte>`, the dynamic invocation and dispatch facility includes interfaces that use the array mapping for the input parameter blob.

Ice provides two overloaded versions of the proxy function `ice_invoke` that use the array mapping. The version that omits the trailing `Ice::Context` argument is shown below:

```
bool ice_invoke(
    const std::string& operation,
    Ice::OperationMode mode,
    const std::pair< const Ice::Byte*, const Ice::Byte* >& in,
    std::vector< Ice::Byte >& out
);
```

A `Blobject` servant uses the array mapping by deriving its implementation class from `Ice::BlobjectArray` and overriding its `ice_invoke` function:

```
class BlobjectArray {
public:
    virtual bool ice_invoke(
        const std::pair<const Ice::Byte*, const Ice::Byte*>& in,
        std::vector<Ice::Byte>& out,
        const Ice::Current& current) = 0;
};
```

See Section 6.7.4 for more information on the array mapping.

36.3.4 Java Mapping

This section describes the Java mapping for the `ice_invoke` proxy function and the `Blobject` class.

`ice_invoke`

The mapping for `ice_invoke` is shown below:

```
boolean ice_invoke(  
    String operation,  
    Ice.OperationMode mode,  
    byte[] inParams,  
    Ice.ByteSeqHolder outParams  
);
```

Another overloading of `ice_invoke` (not shown) adds a trailing argument of type `Ice.Context` (see Section 31.11).

As an example, the code below demonstrates how to invoke the operation `op`, which takes no `in` parameters:

```
Ice.ObjectPrx proxy = ...  
try {  
    Ice.ByteSeqHolder outParams = new Ice.ByteSeqHolder();  
    if (proxy.ice_invoke("op", Ice.OperationMode.Normal, null,  
        outParams)) {  
        // Handle success  
    } else {  
        // Handle user exception  
    }  
} catch (Ice.LocalException ex) {  
    // Handle exception  
}
```

Using Streams with `ice_invoke`

The streaming interface described in Section 36.2 provides the tools an application needs to dynamically invoke operations with arguments of any `Slice` type. Consider the following `Slice` definition:

```
module Calc {  
    exception Overflow {  
        int x;  
        int y;  
    };  
    interface Compute {  
        nonmutating int add(int x, int y)  
            throws Overflow;  
    };  
};
```

Now let's write a client that dynamically invokes the `add` operation:

```

Ice.ObjectPrx proxy = ...
try {
    Ice.OutputStream out =
        Ice.Util.createOutputStream(communicator);
    out.writeInt(100); // x
    out.writeInt(-1); // y
    byte[] inParams = out.finished();
    Ice.ByteSeqHolder outParams = new Ice.ByteSeqHolder();
    if (proxy.ice_invoke("add", Ice.OperationMode.Nonmutating,
        inParams, outParams)) {
        // Handle success
        Ice.InputStream in =
            Ice.Util.createInputStream(communicator,
                                     outParams.value);

        int result = in.readInt();
        assert(result == 99);
    } else {
        // Handle user exception
    }
} catch (Ice.LocalException ex) {
    // Handle exception
}

```

We neglected to handle the case of a user exception in this example, so let's implement that now. We assume that we have compiled our program with the Slice-generated code, therefore we can call `throwException` on the input stream and catch `Overflow` directly⁴:

```

    if (proxy.ice_invoke("add", Ice.OperationMode.Nonmutating,
        inParams, outParams)) {
        // Handle success
        // ...
    } else {
        // Handle user exception
        Ice.InputStream in =
            Ice.Util.createInputStream(communicator,
                                     outParams.value);

        try {
            in.throwException();
        } catch (Calc.Overflow ex) {

```

4. This is obviously a contrived example: if the Slice-generated code is available, why bother using dynamic dispatch? In the absence of Slice-generated code, the caller would need to manually unmarshal the user exception, which is outside the scope of this book.

```
        System.out.println("overflow while adding " + ex.x +
                           " and " + ex.y);
    } catch (Ice.UserException ex) {
        // Handle unexpected user exception
    }
}
```

As a defensive measure, the code traps `Ice.UserException`. This could be raised if the Slice definition of `add` is modified to include another user exception but this segment of code did not get updated accordingly.

Subclassing `Blobject`

Implementing the dynamic dispatch model requires writing a subclass of `Ice.Blobject`. We continue using the `Compute` interface from page 1069 to demonstrate a `Blobject` implementation:

```
public class ComputeI extends Ice.Blobject {
    public boolean ice_invoke(
        byte[] inParams,
        Ice.ByteSeqHolder outParams,
        Ice.Current current)
    {
        // ...
    }
}
```

An instance of `ComputeI` is an `Ice` object because `Blobject` derives from `Object`, therefore an instance can be added to an object adapter like any other servant (see Chapter 31 for more information on object adapters).

For the purposes of this discussion, the implementation of `ice_invoke` handles only the `add` operation and raises `OperationNotExistException` for all other operations. In a real implementation, the servant must also be prepared to receive invocations of the following operations:

- `string ice_id()`
Returns the Slice type id of the servant's most-derived type.
- `StringSeq ice_ids()`
Returns a sequence of strings representing all of the Slice interfaces supported by the servant, including `"::Ice::Object"`.

- `bool ice_isA(string id)`
Returns `true` if the servant supports the interface denoted by the given Slice type `id`, or `false` otherwise. This operation is invoked by the proxy function `checkedCast`.
- `void ice_ping()`
Verifies that the object denoted by the identity and facet contained in `Ice.Current` is reachable.

With that in mind, here is our simplified version of `ice_invoke`:

```
public boolean ice_invoke(
    byte[] inParams,
    Ice.ByteSeqHolder outParams,
    Ice.Current current)
{
    if (current.operation.equals("add")) {
        Ice.Communicator communicator =
            current.adapter.getCommunicator();
        Ice.InputStream in =
            Ice.Util.createInputStream(communicator,
                                     inParams);

        int x = in.readInt();
        int y = in.readInt();
        Ice.OutputStream out =
            Ice.Util.createOutputStream(communicator);
        try {
            if (checkOverflow(x, y)) {
                Calc.Overflow ex = new Calc.Overflow();
                ex.x = x;
                ex.y = y;
                out.writeException(ex);
                outParams.value = out.finished();
                return false;
            } else {
                out.writeInt(x + y);
                outParams.value = out.finished();
                return true;
            }
        } finally {
            out.destroy();
        }
    } else {
        Ice.OperationNotExistException ex =
            new Ice.OperationNotExistException();
        ex.id = current.id;
    }
}
```

```

        ex.facet = current.facet;
        ex.operation = current.operation;
        throw ex;
    }
}

```

If an overflow is detected, the code “raises” the `Calc::Overflow` user exception by calling `writeException` on the output stream and returning `false`, otherwise the return value is encoded and the function returns `true`.

36.3.5 C# Mapping

This section describes the C# mapping for the `ice_invoke` proxy function and the `BlobObject` class.

`ice_invoke`

The mapping for `ice_invoke` is shown below:

```

namespace Ice
{
    public interface ObjectPrx
    {
        bool ice_invoke(string operation,
                       OperationMode mode,
                       byte[] inParams,
                       out byte[] outParams);

        // ...
    }
}

```

Another overloading of `ice_invoke` (not shown) adds a trailing argument of type `Ice.Context` (see Section 31.11).

As an example, the code below demonstrates how to invoke the operation `op`, which takes no `in` parameters:

```

Ice.ObjectPrx proxy = ...
try {
    byte[] outParams;
    if (proxy.ice_invoke("op", Ice.OperationMode.Normal, null,
                        outParams)) {
        // Handle success
    } else {
        // Handle user exception
    }
}

```

```

    }
} catch (Ice.LocalException ex) {
    // Handle exception
}

```

Using Streams with `ice_invoke`

The streaming interface described in Section 36.2 provides the tools an application needs to dynamically invoke operations with arguments of any Slice type. Consider the following Slice definition:

```

module Calc {
    exception Overflow {
        int x;
        int y;
    };
    interface Compute {
        nonmutating int add(int x, int y)
            throws Overflow;
    };
};

```

Now let's write a client that dynamically invokes the `add` operation:

```

Ice.ObjectPrx proxy = ...
try {
    Ice.OutputStream outputStream =
        Ice.Util.createOutputStream(communicator);
    outputStream.writeInt(100); // x
    outputStream.writeInt(-1); // y
    byte[] inParams = outputStream.finished();
    byte[] outParams;
    if (proxy.ice_invoke("add", Ice.OperationMode.NonMutating,
                        inParams, out outParams)) {
        // Handle success
        Ice.InputStream inputStream =
            Ice.Util.createInputStream(communicator, outParams);
        int result = inputStream.readInt();
        System.Diagnostics.Debug.Assert(result == 99);
    } else {
        // Handle user exception
    }
} catch (Ice.LocalException ex) {
    // Handle exception
}

```

We neglected to handle the case of a user exception in this example, so let's implement that now. We assume that we have compiled our program with the Slice-generated code, therefore we can call `throwException` on the input stream and catch `Overflow` directly⁵:

```

    if (proxy.ice_invoke("add", Ice.OperationMode.NonMutating,
                        inParams, out outParams)) {
        // Handle success
        ...
    } else {
        // Handle user exception
        Ice.InputStream inStream =
            Ice.Util.createInputStream(communicator, outParams);
        try {
            inStream.throwException();
        } catch (Calc.Overflow ex) {
            System.Console.WriteLine("overflow while adding " +
                                     ex.x + " and " + ex.y);
        } catch (Ice.UserException) {
            // Handle unexpected user exception
        }
    }
}

```

As a defensive measure, the code traps `Ice.UserException`. This could be raised if the Slice definition of `add` is modified to include another user exception but this segment of code did not get updated accordingly.

Subclassing `Blobject`

Implementing the dynamic dispatch model requires writing a subclass of `Ice.Blobject`. We continue using the `Compute` interface from page 1074 to demonstrate a `Blobject` implementation:

```

public class ComputeI : Ice.Blobject {
    public bool ice_invoke(
        byte[] inParams,
        out byte[] outParams,
        Ice.Current current);
}

```

5. This is obviously a contrived example: if the Slice-generated code is available, why bother using dynamic dispatch? In the absence of Slice-generated code, the caller would need to manually unmarshal the user exception, which is outside the scope of this book.

```

    {
        ...
    }
}

```

An instance of `ComputeI` is an Ice object because `BObject` derives from `Object`, therefore an instance can be added to an object adapter like any other servant (see Chapter 31 for more information on object adapters).

For the purposes of this discussion, the implementation of `ice_invoke` handles only the `add` operation and raises `OperationNotExistException` for all other operations. In a real implementation, the servant must also be prepared to receive invocations of the following operations:

- `string ice_id()`
Returns the Slice type id of the servant's most-derived type.
- `StringSeq ice_ids()`
Returns a sequence of strings representing all of the Slice interfaces supported by the servant, including `"::Ice::Object"`.
- `bool ice_isA(string id)`
Returns `true` if the servant supports the interface denoted by the given Slice type id, or `false` otherwise. This operation is invoked by the proxy function `checkedCast`.
- `void ice_ping()`
Verifies that the object denoted by the identity and facet contained in `Ice.Current` is reachable.

With that in mind, here is our simplified version of `ice_invoke`:

```

public bool ice_invoke(
    byte[] inParams,
    out byte[] outParams,
    Ice.Current current);
{
    if (current.operation.Equals("add")) {
        Ice.Communicator communicator =
            current.adapter.getCommunicator();
        Ice.InputStream inStream =
            Ice.Util.createInputStream(communicator,
                                     inParams);

        int x = inStream.readInt();
        int y = inStream.readInt();
        Ice.OutputStream outStream =
            Ice.Util.createOutputStream(communicator);
    }
}

```

```

    try {
        if (checkOverflow(x, y)) {
            Calc.Overflow ex = new Calc.Overflow();
            ex.x = x;
            ex.y = y;
            outputStream.StreamwriteException(ex);
            outParams = outputStream.finished();
            return false;
        } else {
            outputStream.writeInt(x + y);
            outParams = outputStream.finished();
            return true;
        }
    } finally {
        outputStream.destroy();
    }
} else {
    Ice.OperationNotExistException ex =
        new Ice.OperationNotExistException();
    ex.id = current.id;
    ex.facet = current.facet;
    ex.operation = current.operation;
    throw ex;
}
}
}

```

If an overflow is detected, the code “raises” the `Calc::Overflow` user exception by calling `writeException` on the output stream and returning `false`, otherwise the return value is encoded and the function returns `true`.

36.3.6 Visual Basic Mapping

This section describes the Visual Basic mapping for the `ice_invoke` proxy function and the `BlobObject` class.

`ice_invoke`

The mapping for `ice_invoke` is shown below:

Namespace Ice

```

Public Interface ObjectPrx
    Function ice_invoke(ByVal operation As String, _
                        ByVal mode As OperationMode, _
                        ByVal inParams As Byte(), _

```

```

ByRef outParams As Byte()) _
As Boolean

' ...
End Interface

```

```
End Namespace
```

Another overloading of `ice_invoke` (not shown) adds a trailing argument of type `Ice.Context` (see Section 31.11).

As an example, the code below demonstrates how to invoke the operation `op`, which takes no in parameters:

```

Dim proxy As Ice.ObjectPrx = ...
Try
    Dim outParams As Byte()
    If proxy.ice_invoke("op", Ice.OperationMode.Normal, Nothing, _
        outParams) Then
        ' Handle success
    Else
        ' Handle user exception
    End If
Catch ex As Ice.LocalException
    ' Handle exception
End Try

```

Using Streams with `ice_invoke`

The streaming interface described in Section 36.2 provides the tools an application needs to dynamically invoke operations with arguments of any `Slice` type. Consider the following `Slice` definition:

```

module Calc {
    exception Overflow {
        int x;
        int y;
    };
    interface Compute {
        nonmutating int add(int x, int y)
            throws Overflow;
    };
};

```

Now let's write a client that dynamically invokes the `add` operation:

```

Dim proxy As Ice.ObjectPrx = ...
Try
    Dim outputStream As Ice.OutputStream = _
        Ice.Util.createOutputStream(communicator)
    outputStream.writeInt(100) ' x
    outputStream.writeInt(-1) ' y
    Dim inParams As Byte() = outputStream.finished()
    Dim outParams As Byte()
    If proxy.ice_invoke("add", Ice.OperationMode.NonMutating, _
        inParams, outParams) Then
        ' Handle success
        Dim inputStream As Ice.InputStream = _
            Ice.Util.createInputStream(communicator, outParams)
        Dim result As Integer = inputStream.readInt()
        System.Diagnostics.Debug.Assert(result = 99)
    Else
        ' Handle user exception
    End If
Catch ex As Ice.LocalException ex
    ' Handle exception
End Try

```

We neglected to handle the case of a user exception in this example, so let's implement that now. We assume that we have compiled our program with the Slice-generated code, therefore we can call `throwException` on the input stream and catch `Overflow` directly⁶:

```

    If proxy.ice_invoke("add", Ice.OperationMode.NonMutating, _
        inParams, outParams) Then
        ' Handle success
        ...
    Else
        ' Handle user exception
        Dim inputStream As Ice.InputStream = _
            Ice.Util.createInputStream(communicator, outParams)
        Try
            inputStream.throwException();
        Catch ex As Calc.Overflow ex
            System.Console.WriteLine("overflow while adding " & _
                ex.x & " and " & ex.y)
        End Try
    End If

```

6. This is obviously a contrived example: if the Slice-generated code is available, why bother using dynamic dispatch? In the absence of Slice-generated code, the caller would need to manually unmarshal the user exception, which is outside the scope of this book.

```

        Catch ex As Ice.UserException
            ' Handle unexpected user exception
        End Try
    End If

```

As a defensive measure, the code traps `Ice.UserException`. This could be raised if the `Slice` definition of `add` is modified to include another user exception but this segment of code did not get updated accordingly.

Subclassing `Blobject`

Implementing the dynamic dispatch model requires writing a subclass of `Ice.Blobject`. We continue using the `Compute` interface from page 1078 to demonstrate a `Blobject` implementation:

```

Public Class ComputeI
    Inherits Ice.Blobject

    Public Overrides Function ice_invoke( _
        ByVal inParams() As Byte, _
        ByRef outParams() As Byte, _
        ByVal current As Ice.Current) _
        As Boolean
        ...
    End Function
End Class

```

An instance of `ComputeI` is an `Ice` object because `Blobject` derives from `Object`, therefore an instance can be added to an object adapter like any other servant (see Chapter 31 for more information on object adapters).

For the purposes of this discussion, the implementation of `ice_invoke` handles only the `add` operation and raises `OperationNotExistException` for all other operations. In a real implementation, the servant must also be prepared to receive invocations of the following operations:

- `Function ice_id() As String`
Returns the `Slice` type id of the servant's most-derived type.
- `Function ice_ids() As String()`
Returns a sequence of strings representing all of the `Slice` interfaces supported by the servant, including `"::Ice::Object"`.

- Function `ice_isA(ByVal id As String id) As Boolean`
Returns `True` if the servant supports the interface denoted by the given `Slice` type `id`, or `False` otherwise. This operation is invoked by the proxy function `checkedCast`.
- Sub `ice_ping()`
Verifies that the object denoted by the identity and facet contained in `Ice.Current` is reachable.

With that in mind, here is our simplified version of `ice_invoke`:

```
Public Overrides Function ice_invoke( _
    ByVal inParams() As Byte, _
    ByRef outParams() As Byte, _
    ByVal current As Ice.Current) _
    As Boolean
    If current.operation.Equals("add") Then
        Dim communicator As Ice.Communicator = _
            current.adapter.getCommunicator()
        Dim inStream As Ice.InputStream = _
            Ice.Util.createInputStream(communicator, _
                inParams)
        Dim x As Integer = inStream.readInt()
        Dim y As Integer = inStream.readInt()
        Dim outStream As Ice.OutputStream = _
            Ice.Util.createOutputStream(communicator)
        Try
            If checkOverflow(x, y) Then
                Dim ex As Calc.Overflow ex = new Calc.Overflow
                ex.x = x
                ex.y = y
                outStream.writeException(ex)
                outParams = outStream.finished()
                Return False
            Else
                outStream.writeInt(x + y)
                outParams = outStream.finished()
                Return True
            End If
        Finally
            outStream.destroy()
        End Try
    Else
        Dim ex As Ice.OperationNotExistException = _
            New Ice.OperationNotExistException
        ex.id = current.id
    End If
End Function
```

```

        ex.facet = current.facet
        ex.operation = current.operation
        Throw ex
    End If
End Function

```

If an overflow is detected, the code “raises” the `Calc::Overflow` user exception by calling `writeException` on the output stream and returning `False`, otherwise the return value is encoded and the function returns `True`.

36.4 Asynchronous Dynamic Invocation and Dispatch

Ice provides asynchronous support for the dynamic invocation and dispatch models described in Section 36.3. The mappings for the `ice_invoke` proxy function and the `Blobject` class adhere to the asynchronous mapping rules in Chapter 32.

36.4.1 C++ Mapping

This section describes the asynchronous C++ mapping for the `ice_invoke` proxy function and the `Blobject` class.

`ice_invoke_async`

The asynchronous mapping for `ice_invoke` produces a function named `ice_invoke_async`, as shown below:

```

void ice_invoke_async(
    const Ice::AMI_Object_ice_invokePtr& cb,
    const std::string& operation,
    Ice::OperationMode mode,
    const std::vector<Ice::Byte>& inParams
);

```

Another overloading of `ice_invoke_async` (not shown) adds a trailing argument of type `Ice::Context` (see Section 31.11).

As with any other asynchronous invocation, the first argument to the proxy function is always a callback object. In this case, the callback object must derive from the class `Ice::AMI_Object_ice_invoke`, shown here:

```

namespace Ice {
    class AMI_Object_ice_invoke : ... {
    public:
        virtual void ice_response(
            bool result,
            const std::vector<Ice::Byte>& outParams) = 0;

        virtual void ice_exception(const Ice::Exception& ex) = 0;

        // ...
    };
}

```

The `ice_response` function is invoked for a successful completion or when a user exception occurs. A value of `true` for the first argument signals success; results from the operation are encoded in the second argument `outParams`. A value of `false` for the second argument indicates a user exception was raised, and the encoded form of the exception is provided in `outParams`.

The `ice_exception` function is invoked only when the operation raises a local exception such as `OperationNotExistException`.

BlobjectAsync

`BlobjectAsync` is the name of the asynchronous counterpart to `Blobject`:

```

namespace Ice {
    class BlobjectAsync : virtual public Ice::Object {
    public:
        virtual void ice_invoke_async(
            const AMD_Object_ice_invokePtr& cb,
            const std::vector<Ice::Byte>& inParams,
            const Ice::Current& current) = 0;
    };
}

```

To implement asynchronous dynamic dispatch, a server must subclass `BlobjectAsync` and override `ice_invoke_async`.

As with any other asynchronous operation, the first argument to the servant's member function is always a callback object. In this case, the callback object is of type `Ice::AMD_Object_ice_invoke`, shown here:

```

namespace Ice {
    class AMD_Object_ice_invoke : ... {
    public:
        virtual void ice_response(
            bool result,

```

```

        const std::vector<Ice::Byte>& outParams) = 0;
    virtual void ice_exception(const IceUtil::Exception&) = 0;
    virtual void ice_exception(const std::exception&) = 0;
    virtual void ice_exception() = 0;
};
}

```

Upon a successful invocation, the servant must invoke `ice_response` on the callback, passing `true` as the first argument and encoding the operation results into `outParams`. To report a user exception, the servant invokes `ice_response` with `false` as the first argument and the encoded form of the exception in `outParams`.

The various overloads of `ice_exception` are discussed in Section 32.4.1. Note however that in the dynamic dispatch model, the `ice_exception` function must not be used to report user exceptions; doing so results in the caller receiving `UnknownUserException`.

Array Mapping

The discussion of the synchronous interfaces on page 1068 presented the array mapping for the `ice_invoke` proxy functions and the `BlobObjectArray` base class. The array mapping is also supported in the asynchronous interfaces for dynamic invocation and dispatch.

Ice provides two overloaded versions of the proxy function `ice_invoke_async` that use the array mapping. The version that omits the trailing `Ice::Context` argument is shown below:

```

void ice_invoke_async(
    const Ice::AMI_Array_Object_ice_invokePtr& cb,
    const std::string& operation,
    Ice::OperationMode mode,
    const std::pair<const Ice::Byte*, const Ice::Byte*>& in
);

```

The AMI callback class also supports the array mapping for the encoded out parameter blob, as you can see in its definition of `ice_response`:

```

class AMI_Array_Object_ice_invoke : ... {
public:
    virtual void ice_response(
        bool result,
        const std::pair<const Ice::Byte*, const Ice::Byte*>& out)
        = 0;
};

```

```

        virtual void ice_exception(const Ice::Exception& ex) = 0;

        // ...
    };

```

To implement an asynchronous Blobject servant that uses the array mapping, derive your implementation class from `Ice::BlobjectArrayAsync` and override the `ice_invoke_async` function:

```

class BlobjectArrayAsync : virtual public Ice::Object {
public:
    virtual void ice_invoke_async(
        const AMD_Array_Object_ice_invokePtr& cb,
        const std::pair<const Ice::Byte*, const Ice::Byte*>& in,
        const Ice::Current& current) = 0;
};

```

The AMD callback class also supports the array mapping for the encoded out parameter blob, as shown below for `ice_response`:

```

class AMD_Array_Object_ice_invoke : ... {
public:
    virtual void ice_response(
        bool result,
        const std::pair<const Ice::Byte*, const Ice::Byte*>& out)
        = 0;
    virtual void ice_exception(const IceUtil::Exception&) = 0;
    virtual void ice_exception(const std::exception&) = 0;
    virtual void ice_exception() = 0;
};

```

See Section 6.7.4 for more information on the array mapping.

36.4.2 Java Mapping

This section describes the asynchronous Java mapping for the `ice_invoke` proxy function and the `Blobject` class.

`ice_invoke_async`

The asynchronous mapping for `ice_invoke` produces a function named `ice_invoke_async`, as shown below:

```
public abstract void ice_invoke_async(
    Ice.AMI_Object_ice_invoke cb,
    String operation,
    Ice.OperationMode mode,
    byte[] inParams
);
```

Another overloading of `ice_invoke_async` (not shown) adds a trailing argument of type `Ice.Context` (see Section 31.11).

As with any other asynchronous invocation, the first argument to the proxy function is always a callback object. In this case, the callback object must derive from the class `Ice.AMI_Object_ice_invoke`, shown here:

```
package Ice;

public abstract class AMI_Object_ice_invoke ... {
    public abstract void ice_response(boolean result,
                                     byte[] outParams);
    public abstract void ice_exception(LocalException ex);
}
```

The `ice_response` function is invoked for a successful completion or when a user exception occurs. A value of `true` for the first argument signals success; results from the operation are encoded in the second argument `outParams`. A value of `false` for the second argument indicates a user exception was raised, and the encoded form of the exception is provided in `outParams`.

The `ice_exception` function is invoked only when the operation raises a local exception such as `OperationNotExistException`.

BlobjectAsync

`BlobjectAsync` is the name of the asynchronous counterpart to `Blobject`:

```
package Ice;

public abstract class BlobjectAsync extends Ice.ObjectImpl {
    public abstract void ice_invoke_async(
        Ice.AMI_Object_ice_invoke cb,
        byte[] inParams,
        Ice.Current current
    );

    // ...
}
```

To implement asynchronous dynamic dispatch, a server must subclass `BlobjectAsync` and override `ice_invoke_async`.

As with any other asynchronous operation, the first argument to the servant's member function is always a callback object. In this case, the callback object is of type `Ice.AMD_Object_ice_invoke`, shown here:

```
package Ice;

public interface AMD_Object_ice_invoke {
    void ice_response(boolean result, byte[] outParams);
    void ice_exception(java.lang.Exception ex);
}
```

Upon a successful invocation, the servant must invoke `ice_response` on the callback, passing `true` as the first argument and encoding the operation results into `outParams`. To report a user exception, the servant invokes `ice_response` with `false` as the first argument and the encoded form of the exception in `outParams`.

The `ice_exception` function is discussed in Section 32.4.1. Note however that in the dynamic dispatch model, the `ice_exception` function must not be used to report user exceptions; doing so results in the caller receiving `UnknownUserException`.

36.4.3 C# Mapping

This section describes the asynchronous C# mapping for the `ice_invoke` proxy function and the `Blobject` class.

`ice_invoke_async`

The asynchronous mapping for `ice_invoke` produces a function named `ice_invoke_async`, as shown below:

```
namespace Ice {
    public interface ObjectPrx {
        void ice_invoke_async(AMI_Object_ice_invoke cb,
            string operation,
            OperationMode mode,
            byte[] inParams);
    }
}
```

Another overloading of `ice_invoke_async` (not shown) adds a trailing argument of type `Ice.Context` (see Section 31.11).

As with any other asynchronous invocation, the first argument to the proxy function is always a callback object. In this case, the callback object must derive from the class `Ice.AMI_Object_ice_invoke`, shown here:

```
namespace Ice {

    public abstract class AMI_Object_ice_invoke : ...
    {
        public abstract void ice_response(
            bool ok, byte[] outParams);
        public abstract override void ice_exception(
            Ice.Exception ex);
    }
}
```

The `ice_response` function is invoked for a successful completion or when a user exception occurs. A value of `true` for the first argument signals success; results from the operation are encoded in the second argument `outParams`. A value of `false` for the second argument indicates a user exception was raised, and the encoded form of the exception is provided in `outParams`.

The `ice_exception` function is invoked only when the operation raises a local exception such as `OperationNotExistException`.

BlobjectAsync

`BlobjectAsync` is the name of the asynchronous counterpart to `Blobject`:

```
public abstract class BlobjectAsync
    : Ice.ObjectImpl
{
    public abstract void ice_invoke_async(
        AMD_Object_ice_invoke cb,
        byte[] inParams,
        Current current);
}
```

To implement asynchronous dynamic dispatch, a server must subclass `BlobjectAsync` and override `ice_invoke_async`.

As with any other asynchronous operation, the first argument to the servant's member function is always a callback object. In this case, the callback object is of type `Ice.AMD_Object_ice_invoke`, shown here:

```

namespace Ice
{
    public interface AMD_Object_ice_invoke
    {
        void ice_response(bool ok, byte[] outParams);
        void ice_exception(System.Exception ex);
    }
}

```

Upon a successful invocation, the servant must invoke `ice_response` on the callback, passing `true` as the first argument and encoding the operation results into `outParams`. To report a user exception, the servant invokes `ice_response` with `false` as the first argument and the encoded form of the exception in `outParams`.

The `ice_exception` function is discussed in Section 32.4.1. Note however that in the dynamic dispatch model, the `ice_exception` function must not be used to report user exceptions; doing so results in the caller receiving `UnknownUserException`.

36.4.4 Visual Basic Mapping

This section describes the asynchronous Visual Basic mapping for the `ice_invoke` proxy function and the `Blobject` class.

`ice_invoke_async`

The asynchronous mapping for `ice_invoke` produces a procedure named `ice_invoke_async`, as shown below:

```

Namespace Ice

    Public Interface ObjectPrx
        Sub ice_invoke_async(ByVal cb As AMI_Object_ice_invoke, _
                            ByVal operation As String, _
                            ByVal mode As OperationMode, _
                            ByVal inParams As Byte() InParams)
    End Interface

End Namespace

```

Another overloading of `ice_invoke_async` (not shown) adds a trailing argument of type `Ice.Context` (see Section 31.11).

As with any other asynchronous invocation, the first argument to the proxy function is always a callback object. In this case, the callback object must derive from the class `Ice.AMI_Object_ice_invoke`, shown here:

```

Namespace Ice

    Public MustInherit Class AMI_Object_ice_invoke
        Inherits ...

        Public Overrides MustOverride Sub ice_response( _
            ByVal ok As Boolean, _
            ByVal outParams As Byte())

        Public Overrides MustOverride Sub ice_exception( _
            ByVal ex As Ice.Exception)

    End Class

End Namespace

```

The `ice_response` function is invoked for a successful completion or when a user exception occurs. A value of `True` for the first argument signals success; results from the operation are encoded in the second argument `outParams`. A value of `False` for the second argument indicates a user exception was raised, and the encoded form of the exception is provided in `outParams`.

The `ice_exception` function is invoked only when the operation raises a local exception such as `OperationNotExistException`.

BlobjectAsync

`BlobjectAsync` is the name of the asynchronous counterpart to `Blobject`:

```

Public MustInherit Class BlobjectAsync
    Inherits ...

    Public MustOverride Sub ice_invoke_async(
        ByVal cb As AMD_Object_ice_invoke,
        ByVal inParams As byte(),
        ByVal current As Current)

End Class

```

To implement asynchronous dynamic dispatch, a server must subclass `BlobjectAsync` and override `ice_invoke_async`.

As with any other asynchronous operation, the first argument to the servant's member function is always a callback object. In this case, the callback object is of type `Ice.AMD_Object_ice_invoke`, shown here:

```
Namespace Ice

    Public Interface AMD_Object_ice_invoke
        Sub ice_response(ByVal ok As Boolean, _
            ByVal outParams As Byte())
        Sub ice_exception(ByVal ex As System.Exception)
    End Interface

End Namespace
```

Upon a successful invocation, the servant must invoke `ice_response` on the callback, passing `True` as the first argument and encoding the operation results into `outParams`. To report a user exception, the servant invokes `ice_response` with `False` as the first argument and the encoded form of the exception in `outParams`.

The `ice_exception` function is discussed in Section 32.4.1. Note however that in the dynamic dispatch model, the `ice_exception` function must not be used to report user exceptions; doing so results in the caller receiving `UnknownUserException`.

36.5 Summary

The Ice streaming API allows you to serialize and deserialize Slice types using either the Ice encoding or and encoding of your choice (for example, XML). This is useful, for example, if you want to store Slice types in a data base.

The dynamic invocation and dispatch interfaces allow you to write generic clients and servers that need not have compile-time knowledge of the Slice types used by an application. This is useful for applications such as object browsers, protocol analyzers, or protocol bridges. In addition, the dynamic invocation and dispatch interfaces permit services such as IceStorm to be implemented without the need to unmarshal and remarshal every message, with considerable performance improvements.

Keep in mind that applications that use dynamic invocation and dispatch are tedious to implement and harder to prove correct (because what normally would be a compile-time error appears only as a run-time error with dynamic invocation and dispatch). Therefore, you should use the dynamic interfaces only if your application truly benefits from this trade-off.

Part IV

Ice Services

Chapter 37

IceGrid

37.1 Chapter Overview

In this chapter we present IceGrid, an important service for building robust Ice applications. Section 37.3 introduces the IceGrid architecture and its core concepts. Section 37.4 describes a sample application that we improve incrementally as the chapter progresses. The subject of Section 37.5 is well-known objects, which are a convenient way to decouple clients and servers.

Core IceGrid features such as templates, IceBox integration, replication, load balancing and resource allocation are covered in individual sections from Section 37.6 through Section 37.10.

In Section 37.11 we learn how IceGrid automates the distribution of server executables. IceGrid's support for dynamic monitoring is the subject of Section 37.12, while Section 37.13 gives instructions on integrating a Glacier2 router into an application. Section 37.14 is a reference for the descriptors that define an IceGrid application. Section 37.15 describes the semantics of variables and parameters in descriptors, and property sets are discussed in Section 37.16.

The convenient features that IceGrid supports for XML files are the focus of Section 37.17. Section 37.18 and Section 37.19 address the usage of the IceGrid servers and administrative tools, respectively. Section 37.20 explains the details of server activation, while Section 37.21 provides troubleshooting advice.

37.2 Introduction

IceGrid is the location and activation service for Ice applications. In prior Ice releases, the IcePack service supplied this functionality. Given the increasing importance of grid computing, IceGrid was introduced in Ice 3.0 to support all of IcePack's responsibilities and extend it with new features to simplify the development and administration of Ice applications on grid networks.

For the purposes of this chapter, we can loosely define *grid computing* as the use of a network of relatively inexpensive computers to perform the computational tasks that once required costly "big iron." Developers familiar with distributed computing technologies such as Ice and CORBA may not consider the notion of grid computing to be particularly revolutionary; after all, distributed applications have been running on networks for years, and the definition of grid computing is sufficiently vague that practically any server environment could be considered a "grid."

One possible grid configuration is a homogeneous collection of computers running identical programs. Each computer in the grid is essentially a clone of the others, and all are equally capable of handling a task. As a developer, you need to write the code that runs on the grid computers, and Ice is ideally suited as the infrastructure that enables the components of a grid application to communicate with one another. However, writing the application code is just the first piece of the puzzle. Many other challenges remain:

- How do I install and update this application on all of the computers in the grid?
- How do I keep track of the servers running on the grid?
- How do I distribute the load across all the computers?
- How do I migrate a server from one computer to another one?
- How can I quickly add a new computer to the grid?

Of course, these are issues faced by most distributed applications. As you read this chapter and learn more about IceGrid's capabilities, you will discover that it offers solutions to these challenges. To get you started, we have summarized IceGrid's feature set below:

- Location service

As an implementation of an Ice location service (see Section 31.17), IceGrid enables clients to bind indirectly to their servers, making applications more flexible and resilient to changing requirements.

- **On-demand server activation**

Starting an Ice server process is called *server activation*. IceGrid can be given responsibility for activating a server on demand, that is, when a client attempts to access an object hosted by the server. Activation usually occurs as a side effect of indirect binding, and is completely transparent to the client.
- **Application distribution**

IceGrid provides a convenient way to distribute your application to a set of computers, without the need for a shared file system or complicated scripts. Simply configure an IcePatch2 server (see Chapter 44) and let IceGrid download the necessary files and keep them synchronized.
- **Replication and load balancing**

IceGrid supports replication by grouping the object adapters of several servers into a single virtual object adapter. During indirect binding, a client can be bound to an endpoint of any of these adapters. Furthermore, IceGrid monitors the load on each computer and can use that information to decide which of the endpoints to return to a client.
- **Sessions and resource allocation**

An IceGrid client establishes a session in order to allocate a resource such as an object or a server. IceGrid prevents other clients from using the resource until the client releases it or the session expires. Sessions enhance security through the use of an authentication mechanism that can be integrated with a Glacier2 router.
- **Automatic failover**

Ice supports automatic retry and failover in any proxy that contains multiple endpoints. When combined with IceGrid's support for replication and load balancing, automatic failover means that a failed request results in a client transparently retrying the request on the next endpoint with the lowest load.
- **Dynamic queries**

In addition to transparent binding, applications can interact directly with IceGrid to locate objects in a variety of ways.
- **Status monitoring**

IceGrid supports Slice interfaces that allow applications to monitor its activities and receive notifications about significant events, enabling the development of custom tools or the integration of IceGrid status events into an existing management framework.

- Administration

IceGrid includes command-line and graphical administration tools. They are available on all supported platforms and allow you to start, stop, monitor, and reconfigure any server managed by IceGrid.

- Deployment

Using XML files, you can describe the servers to be deployed on each computer. Templates simplify the description of identical servers.

As grid computing enters the mainstream and compute servers become commodities, users expect more value from their applications. IceGrid, in cooperation with the Ice run time, relieves you of these low-level tasks to accelerate the construction and simplify the administration of your distributed applications.

37.3 IceGrid Architecture

An IceGrid domain consists of a single *registry* and any number of *nodes*. Together, the registry and nodes cooperate to manage the information and server processes that comprise *applications*. Each application assigns servers to particular nodes. The registry maintains a persistent record of this information, while the nodes are responsible for starting and monitoring their assigned server processes. In a typical configuration, one node runs on each computer that hosts Ice servers. The registry does not consume much processor time, so it commonly runs on the same computer as a node; in fact, the registry and a node can run in the same process if desired.

37.3.1 Simple Example

As an example, Figure 37.1 shows a very simple IceGrid application running on a network of three computers. The IceGrid registry is the only process of interest on

host PC1, while IceGrid nodes are running on the hosts PC2 and PC3. In this sample application, one server has been assigned to each node.

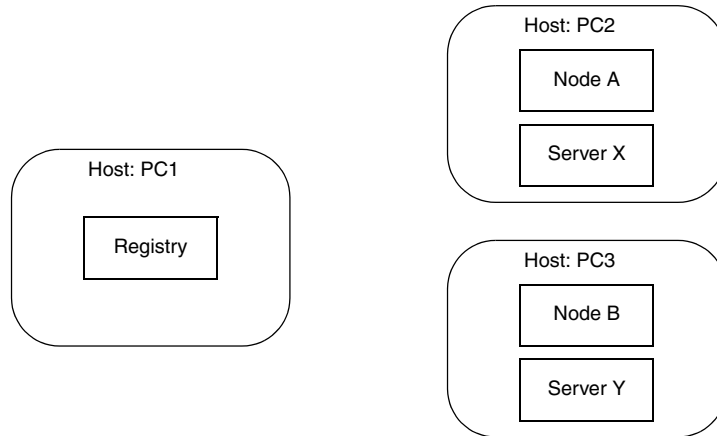

Figure 37.1. Simple IceGrid application.

From a client application's perspective, the primary responsibility of the registry is to resolve indirect proxies as an Ice location service (see Section 31.17). As such, this contribution is largely transparent: when a client first attempts to use an indirect proxy, the Ice run time in the client contacts the registry to convert the proxy's symbolic information into endpoints that allow the client to establish a connection.

Although the registry might sound like nothing more than a simple lookup table, reality is quite different. For example, behind the scenes, a locate request might prompt a node to start the target server automatically, or the registry might select appropriate endpoints based on load statistics from each computer.

This also illustrates the benefits of indirect proxies: the location service can provide a great deal of functionality without any special action by the client and, unlike with direct proxies, the client does not need advance knowledge of the address and port of a server. The extra level of indirection adds some latency to the client's first use of a proxy; however, all subsequent interactions occur directly between client and server, so the cost is negligible. Furthermore, indirection allows servers to migrate to different computers without the need to update proxies held by clients.

37.3.2 Replication

IceGrid's flexibility allows an endless variety of configurations. For example, suppose we have a grid network and want to replicate a server on each blade, as shown in Figure 37.2.

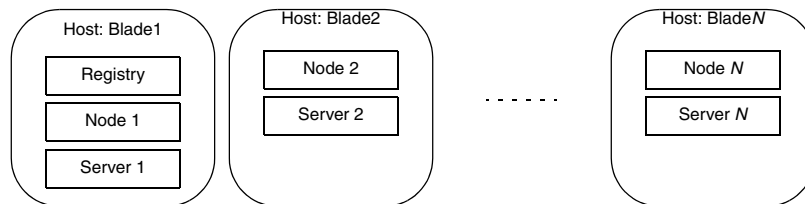

Figure 37.2. Replicated server on grid network.

Replication in Ice is based on object adapters, not servers. Any object adapter in any server could participate in replication, but it is far more likely that all of the replicated object adapters are created by instances of the same server executable that is running on each computer. We are using this configuration in the example shown above, but IceGrid requires each server to have a unique name. `Server 1` and `Server 2` are our unique names for the same executable.

The binding process works somewhat differently when replication is involved, since the registry now has multiple object adapters to choose from. The description of the IceGrid application drives the registry's decision about which object adapter (or object adapters) to use. For example, the registry could consider the system load of each computer (as periodically reported by the nodes) and return the endpoints of the object adapter on the computer with the lowest load. It is also possible for the registry to combine the endpoints of several object adapters, in which case the Ice run time in the client would select the endpoint for the initial connection attempt.

37.3.3 Deployment

In IceGrid, *deployment* is the process of describing an application to the registry. This description includes the following information:

- Replica groups

A *replica group* is the term for a collection of replicated object adapters. An application can create any number of replica groups. Each group requires a unique identifier.

- Nodes

An application must assign its servers to one or more nodes.

- Servers

A server's description includes a unique name and the path to its executable. It also lists the object adapters it creates.

- Object adapters

Information about an object adapter includes its endpoints and any well-known objects it advertises. If the object adapter is a member of a replica group, it must also supply that group's identifier.

- Objects

A *well-known object* is one that is known solely by its identity. The registry maintains a global list of such objects for use during locate requests.

IceGrid uses the term *descriptor* to refer to the description of an application and its components; deploying an application involves creating its descriptors in the registry. There are several ways to accomplish this:

- You can use a command-line tool that reads XML descriptors.
- You can create descriptors interactively with the graphical administration tool.
- You can create descriptors programmatically via IceGrid's administrative interface.

The registry server must be running in order to deploy an application, but it is not necessary for nodes to be active. Nodes that are started after deployment automatically retrieve the information they need from the registry. Once deployed, you can update the application at any time.

37.4 Getting Started

This section introduces a sample application that will help us demonstrate IceGrid's capabilities. Our application "rips" music tracks from a compact disc (CD) and encodes them as MP3 files, as shown in Figure 37.3.

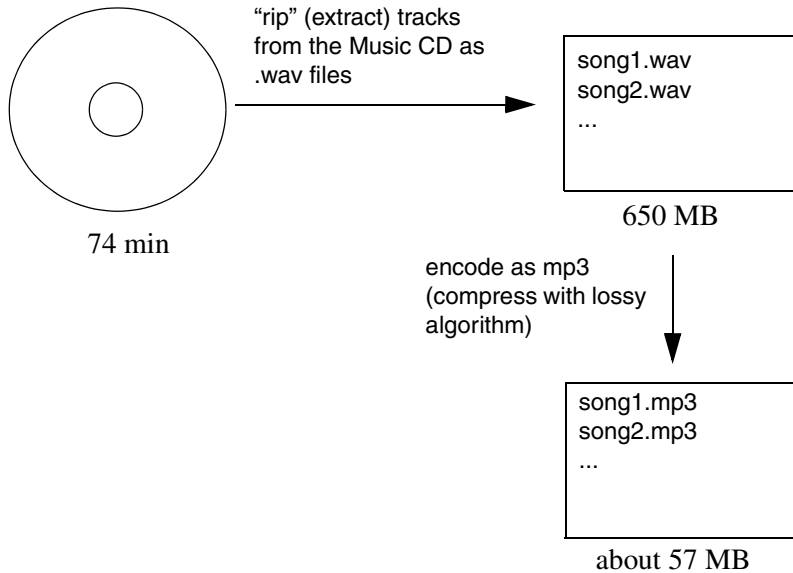

Figure 37.3. Overview of sample application.

Ripping an entire CD usually takes several minutes because the MP3 encoding requires lots of CPU cycles. Our distributed ripper application accelerates this process by taking advantage of powerful CPUs on remote Ice servers, enabling us to process many songs in parallel.

The Slice interface for the MP3 encoder is straightforward:

```

module Ripper {
exception EncodingFailedException {
    string reason;
};

sequence<short> Samples;
  
```

```
interface Mp3Encoder {
    // Input: PCM samples for left and right channels
    // Output: MP3 frame(s).
    Ice::ByteSeq encode(Samples leftSamples, Samples rightSamples)
        throws EncodingFailedException;

    // You must flush to get the last frame(s). Flush also
    // destroys the encoder object.
    Ice::ByteSeq flush()
        throws EncodingFailedException;
};

interface Mp3EncoderFactory
{
    Mp3Encoder* createEncoder();
};
};
```

The implementation of the encoding algorithm is not relevant for the purposes of this discussion. Instead, we will focus on incrementally improving the application as we discuss IceGrid features.

37.4.1 Architecture

The initial architecture for our application is intentionally simple, consisting of a single IceGrid node responsible for our encoding server and running on the computer named `ComputeServer`. Figure 37.4 shows the client's invocation of

`createEncoder` and the actions that IceGrid takes to make this invocation possible.

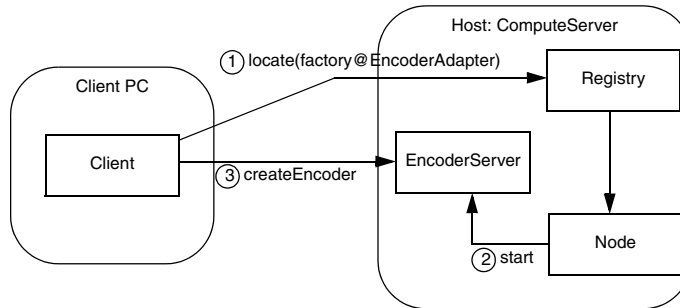

Figure 37.4. Architecture for initial ripper application.

The corresponding C++ code for the client is presented below:

```

Ice::ObjectPrx proxy =
    communicator->stringToProxy("factory@EncoderAdapter");
Ripper::MP3EncoderFactoryPrx factory =
    Ripper::MP3EncoderFactoryPrx::checkedCast(proxy);
Ripper::MP3EncoderPrx encoder = factory->createEncoder();
  
```

Notice that the client uses an indirect proxy for the `MP3EncoderFactory` object. This stringified proxy can be read literally as “the object with identity `factory` in the object adapter identified as `EncoderAdapter`.” The encoding server creates this object adapter, and its IceGrid descriptor ensures that the object adapter uses this identifier. Since each object adapter must be uniquely identified, the registry can easily determine the server that creates the adapter, and the node responsible for that server. It is then the node’s responsibility to start the server if necessary.

The client’s call to `checkedCast` is actually the first remote invocation on the factory object. Once the server is started and the object adapter has registered itself, `checkedCast` completes and the client invokes `createEncoder` without further involvement by IceGrid.

37.4.2 Descriptors

We can deploy our application using the `icegridadmin` command line utility (see Section 37.19.1), but first we must define our descriptors in XML. For our initial architecture, the descriptors are quite brief:

```
<icegrid>
  <application name="Ripper">
    <node name="Node1">
      <server id="EncoderServer"
        exe="/opt/ripper/bin/server"
        activation="on-demand">
        <adapter name="EncoderAdapter"
          id="EncoderAdapter"
          register-process="true"
          endpoints="tcp"/>
      </server>
    </node>
  </application>
</icegrid>
```

For IceGrid's purposes, we have named our application `Ripper`. It consists of a single server, `EncoderServer`, assigned to the node `Node1`¹. The server's `exe` attribute supplies the pathname of its executable, and the `activation` attribute indicates that the server should be activated on demand when necessary.

The object adapter's descriptor is the most interesting. As you can see, the `name` and `id` attributes both specify the value `EncoderAdapter`. The value of `name` reflects the adapter's name in the server process (i.e., the argument passed to `createObjectAdapter`) that is used for configuration purposes, whereas the value of `id` uniquely identifies the adapter within the registry and is used in indirect proxies. These attributes are not required to have the same value. Had we omitted the `id` attribute, IceGrid would have composed a unique value by combining the server name and adapter name to produce the following identifier:

```
EncoderServer.EncoderAdapter
```

The `register-process` attribute makes it possible for IceGrid to gracefully shut down the server when necessary (see Section 31.17.6), while `endpoints` defines one or more endpoints for the adapter.

1. Since a computer typically runs only one node process, you might be tempted to give the node a name that identifies its host (such as `ComputeServerNode`). However, this naming convention becomes problematic as soon as you need to migrate the node to another host.

Note that the value for `endpoints` does not contain any port information, meaning that the adapter uses a system-assigned port. Without IceGrid, the use of a system-assigned port would pose a significant problem: how would a client create a direct proxy if the adapter's port could change every time the server is restarted? IceGrid solves this problem nicely because clients can use indirect proxies that contain no endpoint dependencies. The registry resolves indirect proxies using the endpoint information supplied by object adapters each time they are activated.

See Section 37.14 for detailed information on using XML to define descriptors.

37.4.3 Configuring the Registry and Node

The registry needs a subdirectory in which to create its databases, and the node needs a subdirectory for its own purposes. The server descriptor in Section 37.4.2 states that the executable resides in the directory `/opt/ripper/bin`, so we will add the subdirectories `/opt/ripper/registry` and `/opt/ripper/node` for use by the registry and node, respectively. These directories must exist before starting the registry and node.

We also need to create an Ice configuration file to hold properties required by the registry and node. The file `/opt/ripper/config` contains the following properties:

```
# Registry properties
IceGrid.Registry.Client.Endpoints=tcp -p 10000
IceGrid.Registry.Server.Endpoints=tcp
IceGrid.Registry.Admin.Endpoints=tcp
IceGrid.Registry.Internal.Endpoints=tcp
IceGrid.Registry.Data=/opt/ripper/registry

# Node properties
IceGrid.Node.Endpoints=tcp
IceGrid.Node.Name=Node1
IceGrid.Node.Data=/opt/ripper/node
IceGrid.Node.CollocateRegistry=1
Ice.Default.Locator=IceGrid/Locator:tcp -p 10000
```

The registry and node can share this configuration file. In fact, by defining `IceGrid.Node.CollocateRegistry=1`, we have indicated that the registry and node should run in the same process.

Several of the properties define endpoints, but only the value of `IceGrid.Registry.Client.Endpoints` needs a fixed port. This prop-

erty specifies the endpoints of the IceGrid locator service. IceGrid clients must include these endpoints in their definition of `Ice.Default.Locator`, as discussed in the next section.

Another property of interest is `IceGrid.Node.Name`, whose value is `Node1`. You may recall seeing this name mentioned in the descriptors from Section 37.4.2.

Finally, `Ice.Default.Locator` is used by the node to contact the registry. The next section provides more information on this property.

37.4.4 Configuring the Client

The client requires only minimal configuration, namely a value for the property `Ice.Default.Locator` (see Section 31.17.3). This property supplies the Ice run time with the proxy for the locator service. In IceGrid, the locator service is implemented by the registry, and the locator object is available on the registry's client endpoints. The property `IceGrid.Registry.Client.Endpoints` defined in the previous section provides most of the information we need to construct the proxy. The missing piece is the identity of the locator object, which defaults to `IceGrid/Locator`:

```
Ice.Default.Locator=IceGrid/Locator:tcp -h registryhost -p 10000
```

The use of a locator service allows the client to take advantage of indirect binding and avoid static dependencies on server endpoints. However, the locator proxy must have a fixed port, otherwise the client has a bootstrapping problem: it cannot resolve indirect proxies without knowing the endpoints of the locator service.

See Section 37.18.3 for more information on client configuration.

37.4.5 Configuring the Server

Server configuration is accomplished using descriptors. During deployment, the node creates a subdirectory tree for each server. Inside this tree the node creates a configuration file containing properties derived from the server's descriptors. For instance, the adapter's descriptor in Section 37.4.2 generates the following properties in the server's configuration file:

```
EncoderAdapter.AdapterId=EncoderAdapter  
EncoderAdapter.RegisterProcess=1  
EncoderAdapter.Endpoints=tcp
```

Using the directory structure we established for our ripper application, the configuration file for EncoderServer has the filename shown below:

```
/opt/ripper/node/servers/EncoderServer/config/config
```

Note that this file should not be edited directly because any changes you make are lost the next time the node regenerates the file. The correct way to add properties to the file is to include property definitions in the server's descriptor. For example, we can add the property `Ice.Trace.Network=1` by modifying the server descriptor as follows:

```
<icegrid>
  <application name="Ripper">
    <node name="Node1">
      <server id="EncoderServer"
        exe="/opt/ripper/bin/server"
        activation="on-demand">
        <adapter name="EncoderAdapter"
          id="EncoderAdapter"
          register-process="true"
          endpoints="tcp"/>
        <property name="Ice.Trace.Network"
          value="1"/>
      </server>
    </node>
  </application>
</icegrid>
```

When a node activates a server, it passes the location of the server's configuration file using the `--Ice.Config` command-line argument. If you start a server manually from a command prompt, you must supply this argument yourself.

37.4.6 Starting IceGrid

Now that the configuration file is written and the directory structure is prepared, we are ready to start the IceGrid registry and node. Using a collocated registry and node, we only need to use one command:

```
$ icegridnode --Ice.Config=/opt/ripper/config
```

Additional command line options are supported, including those that allow the node to run as a Windows service or Unix daemon. See Section 37.18.2 for more information.

37.4.7 Deploying the Application

With the registry up and running, it is now time to deploy our application. Like our client, the `icegridadmin` utility also requires a definition for the `Ice.Default.Locator` property. We can start the utility with the following command:

```
$ icegridadmin --Ice.Config=/opt/ripper/config
```

After confirming that it can contact the registry, `icegridadmin` provides a command prompt at which we deploy our application. Assuming our descriptor is stored in `/opt/ripper/app.xml`, the deployment command is shown below:

```
>>> application add "/opt/ripper/app.xml"
```

Next, confirm that the application has been deployed:

```
>>> application list
Ripper
```

You can start the server using this command:

```
>>> server start EncoderServer
```

Finally, retrieve the current endpoints of the object adapter:

```
>>> adapter endpoints EncoderAdapter
```

If you want to experiment further using `icegridadmin`, issue the `help` command and see Section 37.19.1.

37.4.8 Review

We have deployed our first IceGrid application, but you might be questioning whether it was worth the effort. Even at this early stage, we have already gained several benefits:

- Our client can locate the `MP3EncoderFactory` object using only an indirect proxy and a value for `Ice.Default.Locator`. We can reconfigure the IceGrid application in any number of ways without modifying the client's code or configuration in any way.
- We no longer need to manually start the encoder server before starting the client, because the IceGrid node automatically starts it if it is not active at the time a client needs it. If the server happens to terminate for any reason, such as an IceGrid administrative action or a server programming error, the node restarts it without intervention on our part.

- We can manage the application remotely using one of the IceGrid administration tools. The ability to remotely modify applications, start and stop servers, and inspect every aspect of your configuration is a significant advantage.

Admittedly, we have not made much progress yet in our stated goal of improving the performance of the ripper over alternative solutions that are restricted to running on a single computer. Our client now has the ability to easily delegate the encoding task to a server running on another computer, but we have not achieved the parallelism that we really need. For example, if the client created a number of encoders and used them simultaneously from multiple threads, the encoding performance might actually be *worse* than simply encoding the data directly in the client, as the remote computer would likely slow to a crawl while attempting to task-switch among a number of processor-intensive tasks.

37.4.9 Adding Nodes

Adding more nodes to our environment would allow us to distribute the encoding load to more compute servers. Using the techniques we have learned so far, let us investigate the impact that adding a node would have on our descriptors, configuration, and client application.

Descriptors

The addition of a node is mainly an exercise in cut and paste:

```
<icegrid>
  <application name="Ripper">
    <node name="Node1">
      <server id="EncoderServer1"
        exe="/opt/ripper/bin/server"
        activation="on-demand">
        <adapter name="EncoderAdapter"
          register-process="true"
          endpoints="tcp"/>
      </server>
    </node>
    <node name="Node2">
      <server id="EncoderServer2"
        exe="/opt/ripper/bin/server"
        activation="on-demand">
        <adapter name="EncoderAdapter"
          register-process="true"
          endpoints="tcp"/>
    </node>
  </application>
</icegrid>
```

```
        </server>
    </node>
</application>
</icegrid>
```

Note that we now have two `node` elements instead of a single one. You might be tempted to simply use the host name as the node name. However, in general, that is not a good idea. For example, you may want to run several IceGrid nodes on a single machine (for example, for testing). Similarly, you may have to rename a host at some point, or need migrate a node to a different host. But, unless you also rename the node, that leads to the situation where you have a node with the name of a (possibly obsolete) host when the node in fact is not running on that host. Obviously, this makes for a confusing configuration—it is better to use abstract node names, such as `Node1`.

Aside from the new `node` element, notice that the server identifiers must be unique. The adapter name, however, can remain as `EncoderAdapter` because this name is used only for local purposes within the server process. In fact, using a different name for each adapter would actually complicate the server implementation, since it would somehow need to discover the name it should use when creating the adapter.

We have also removed the `id` attribute from our adapter descriptors; the default values supplied by IceGrid are sufficient for our purposes (see Section 37.14.1).

Configuration

We can continue to use the configuration file we created in Section 37.4.3 for our combined registry-node process. We need a separate configuration file for `Node2`, primarily to define a different value for the property `IceGrid.Node.Name`. However, we also cannot have two nodes configured with `IceGrid.Node.CollocateRegistry=1` because only one registry is allowed, so we must remove this property:

```
IceGrid.Node.Endpoints=tcp
IceGrid.Node.Name=Node2
IceGrid.Node.Data=/opt/ripper/node
```

```
Ice.Default.Locator=IceGrid/Locator:tcp -h registryhost -p 10000
```

We assume that `/opt/ripper/node` refers to a local file system directory on the computer hosting `Node2`, and not a shared volume, because two nodes must not share the same data directory.

We have also modified the locator proxy to include the address of the host on which the registry is running.

Redeploying

After saving the new descriptors, you need to redeploy the application. Using `icegridadmin`, issue the following commands:

```
$ icegridadmin --Ice.Config=/opt/ripper/config
>>> application remove "Ripper"
>>> application add "/opt/ripper/app.xml"
```

Client

We have added a new node, but we still need to modify our client to take advantage of it. As it stands now, our client can delegate an encoding task to one of the two `MP3EncoderFactory` objects. The client selects a factory by using the appropriate indirect proxy:

- `factory@EncoderServer1.EncoderAdapter`
- `factory@EncoderServer2.EncoderAdapter`

In order to distribute the tasks among both factories, the client could use a random number generator to decide which factory receives the next task:

```
string adapter;
if ((rand() % 2) == 0)
    adapter = "EncoderServer1.EncoderAdapter";
else
    adapter = "EncoderServer2.EncoderAdapter";
Ice::ObjectPrx proxy =
    communicator->stringToProxy("factory@" + adapter);
Ripper::MP3EncoderFactoryPrx factory =
    Ripper::MP3EncoderFactoryPrx::checkedCast(proxy);
Ripper::MP3EncoderPrx encoder = factory->createEncoder();
```

There are a few disadvantages in this design:

- The client application must be modified each time a new compute server is added or removed because it knows all of the adapter identifiers.
- The client cannot distribute the load intelligently; it is just as likely to assign a task to a heavily-loaded computer as it is an idle one.

We describe better solutions in the sections that follow.

37.5 Well-known Objects

There are two types of indirect proxies (see Section 2.2.2): one specifies an identity and an object adapter identifier, while the other contains only an identity. The latter type of indirect proxy is known as a *well-known proxy*. A well-known proxy refers to a well-known object, that is, its identity alone is sufficient to allow the client to locate it. Ice requires all object identities in an application to be unique, but typically only a select few objects are able to be located via only their identities.

In earlier sections we showed the relationship between indirect proxies containing an object adapter identifier and the IceGrid configuration. Briefly, in order for a client to use a proxy such as `factory@EncoderAdapter`, an object adapter must be given the identifier `EncoderAdapter`.

A similar requirement exists for well-known objects. The registry maintains a table of these objects, which can be populated in a number of ways:

- statically in descriptors,
- programmatically using IceGrid's administrative interface,
- dynamically using an IceGrid administration tool.

The registry's database maps an object identity to a proxy. A locate request containing only an identity prompts the registry to consult this database. If a match is found, the registry examines the associated proxy to determine if additional work is necessary. For example, consider the well-known objects in Table 37.1.

Table 37.1. Well-known objects and their proxies.

Identity	Proxy
Object1	Object1:tcp -p 10001
Object2	Object2@TheAdapter
Object3	Object3

The proxy associated with `Object1` already contains endpoints, so the registry can simply return this proxy to the client.

For `Object2`, the registry notices the adapter id and checks to see whether it knows about an adapter identified as `TheAdapter`. If it does, it attempts to obtain the endpoints of that adapter, which may cause its server to be started. If the registry is successfully able to determine the adapter's endpoints, it returns a direct proxy containing those endpoints to the client. If the registry does not recognize `TheAdapter` or cannot obtain its endpoints, it returns the indirect proxy `Object2@TheAdapter` to the client. Upon receipt of another indirect proxy, the Ice run time in the client will try once more to resolve the proxy, but generally this will not succeed and the Ice run time in the client will raise a `NoEndpointException` as a result.

Finally, `Object3` represents a hopeless situation: how can the registry resolve `Object3` when its associated proxy refers to itself? In this case, the registry returns the proxy `Object3` to the client, which causes the client to raise `NoEndpointException`. Clearly, you should avoid this situation.

37.5.1 Object Types

The registry's database not only associates an identity with a proxy, but also a type. Technically, the "type" is an arbitrary string but, by convention, that string represents the most-derived `Slice` type of the object. For example, the `Slice` type of the encoder factory in our ripper application is

```
::Ripper::MP3EncoderFactory.
```

Object types are useful when performing queries, as discussed in Section 37.5.5.

37.5.2 Object Descriptors

The object descriptor (see Section 37.14.13) adds a well-known object to the registry. It must appear within the context of an adapter descriptor, as shown in the XML example below:

```
<icegrid>
  <application name="Ripper">
    <node name="Node1">
      <server id="EncoderServer"
        exe="/opt/ripper/bin/server"
        activation="on-demand">
        <adapter name="EncoderAdapter"
          id="EncoderAdapter"
          register-process="true"
          endpoints="tcp">
```



```

        <object identity="EncoderFactory"
            type="::Ripper::MP3EncoderFactory"/>
    </adapter>
</server>
</node>
</application>
</icegrid>

```

During deployment, the registry associates the identity `EncoderFactory` with the indirect proxy `EncoderFactory@EncoderAdapter`. If the adapter descriptor had omitted the adapter id, the registry would have generated a unique identifier using the server id and the adapter name.

In this example, the object's type is specified explicitly. See Section 37.5.1 for more information on object types.

37.5.3 Adding Objects in a Program

The `IceGrid::Admin` interface defines several operations that manipulate the registry's database of well-known objects:

```

module IceGrid {
interface Admin {
    ...
    void addObject(Object* obj)
        throws ObjectExistsException,
            DeploymentException;
    void updateObject(Object* obj)
        throws ObjectNotRegisteredException,
            DeploymentException;
    void addObjectWithType(Object* obj, string type)
        throws ObjectExistsException,
            DeploymentException;
    void removeObject(Ice::Identity id)
        throws ObjectNotRegisteredException,
            DeploymentException;
    ...
};
};

```

- `addObject`

The `addObject` operation adds a new object to the database. The proxy argument supplies the identity of the well-known object. If an object with the same identity has already been registered, the operation raises `ObjectExistsException`. Since this operation does not accept an argument supplying the

object's type, the registry invokes `ice_id` on the given proxy to determine its most-derived type. The implication here is that the object must be available in order for the registry to obtain its type. If the object is not available, `addObject` raises `DeploymentException`.

- `updateObject`

The `updateObject` operation supplies a new proxy for the well-known object whose identity is encapsulated by the proxy. If no object with the given identity is registered, the operation raises `ObjectNotRegisteredException`. The object's type is not modified by this operation.

- `addObjectWithType`

The `addObjectWithType` operation behaves like `addObject`, except the object's type is specified explicitly and therefore the registry does not attempt to invoke `ice_id` on the given proxy (even if the type is an empty string).

- `removeObject`

The `removeObject` operation removes the well-known object with the given identity from the database. If no object with the given identity is registered, the operation raises `ObjectNotRegisteredException`.

The following C++ example produces the same result as deploying the descriptor in Section 37.5.2:

```
Ice::ObjectAdapterPtr adapter =
    communicator->createObjectAdapter("EncoderAdapter");
Ice::Identity id =
    communicator->stringToIdentity("EncoderFactory");
Ice::ObjectPrx factory = adapter->add(new FactoryI, id);
Ice::ObjectPrx proxy =
    communicator->stringToProxy("IceGrid/Admin");
IceGrid::AdminPrx admin = IceGrid::AdminPrx::checkedCast(proxy);
try {
    admin->addObject(factory); // OOPS!
} catch (const IceGrid::ObjectExistsException &) {
    admin->updateObject(factory);
}
```

The first noteworthy aspect of this example is the proxy it constructs for the `IceGrid::Admin` object, which is available as a well-known object with the default identity `IceGrid/Admin`.

Next, notice that the code traps `ObjectExistsException` and calls `updateObject` instead when the object is already registered.

There is one subtle problem in this code: calling `addObject` causes the registry to invoke `ice_id` on our factory object, but we have not yet activated the object adapter. As a result, our program will hang indefinitely at the call to `addObject`. One solution is to activate the adapter prior to the invocation of `addObject`; another solution is to use `addObjectWithType` as shown below:

```
Ice::ObjectAdapterPtr adapter =
    communicator->createObjectAdapter("EncoderAdapter");
Ice::Identity ident =
    communicator->stringToIdentity("EncoderFactory");
Ice::ObjectPrx factory = adapter->add(new FactoryI, ident);
Ice::ObjectPrx proxy =
    communicator->stringToProxy("IceGrid/Admin");
IceGrid::AdminPrx admin = IceGrid::AdminPrx::checkedCast(proxy);
try {
    admin->addObjectWithType(factory, factory->ice_id());
} catch (const IceGrid::ObjectExistsException &) {
    admin->updateObject(factory);
}
```

37.5.4 Adding Objects with `icegridadmin`

The `icegridadmin` utility (see Section 37.19.1) provides commands that are the functional equivalents of the Slice operations shown in Section 37.5.3. We can use the utility to manually register the `EncoderFactory` object from Section 37.5.2:

```
$ icegridadmin --Ice.Config=/opt/ripper/config
>>> object add "EncoderFactory@EncoderAdapter"
```

Use the `object list` command to verify that the object was registered successfully:

```
>>> object list
EncoderFactory
IceGrid/Admin
IceGrid/Query
IceGrid/SessionManager
```

To specify the object's type explicitly, append it to the `object add` command:

```
>>> object add "EncoderFactory@EncoderAdapter" \
"::Ripper::MP3EncoderFactory"
```

Finally, the object is removed from the registry like this:

```
>>> object remove "EncoderFactory"
```

37.5.5 Queries

The registry's database of well-known objects is not used solely for resolving indirect proxies. The database can also be queried interactively to find objects in a variety of ways. The `IceGrid::Query` interface supplies this functionality:

```
module IceGrid {
  enum LoadSample {
    LoadSample1,
    LoadSample5,
    LoadSample15
  };

  interface Query {
    nonmutating Object* findObjectById(Ice::Identity id);
    nonmutating Object* findObjectByType(string type);
    nonmutating Object* findObjectByTypeOnLeastLoadedNode(
      string type, LoadSample sample);
    nonmutating Ice::ObjectProxySeq findAllObjectsByType(
      string type);
  };
};
```

- `findObjectById`

The `findObjectById` operation returns the proxy associated with the given identity of a well-known object. It returns a null proxy if no match was found.

- `findObjectByType`

The `findObjectByType` operation returns a proxy for an object registered with the given type. If more than one object has the same type, the registry selects one at random. The operation returns a null proxy if no match was found.

- `findObjectByTypeOnLeastLoadedNode`

The `findObjectByTypeOnLeastLoadedNode` operation considers the system load when selecting one of the objects with the given type. If the registry is unable to determine which node hosts an object (for example, because the object was registered with a direct proxy and not an adapter id), the object is considered to have a load value of 1 for the purposes of this operation. The `sample` argument determines the interval over which the loads are averaged

(one, five, or fifteen minutes). The operation returns a null proxy if no match was found.

- `findAllObjectsByType`

The `findAllObjectsByType` operation returns a sequence of proxies representing the well-known objects having the given type. The operation returns an empty sequence if no match was found.

Be aware that the operations accepting a type parameter are not equivalent to invoking `ice_isA` on each object to determine whether it supports the given type, a technique that would not scale well as the for a large number of registered objects. Rather, the operations simply compare the given type to the object's registered type or, if the object was registered without a type, to the object's most-derived Slice type as determined by the registry (see Section 37.5.1).

37.5.6 Application Changes

Well-known objects are another IceGrid feature we can incorporate into our ripper application.

Descriptors

First we'll modify the descriptors from Section 37.4.9 to add two well-known objects:

```
<icegrid>
  <application name="Ripper">
    <node name="Node1">
      <server id="EncoderServer1"
        exe="/opt/ripper/bin/server"
        activation="on-demand">
        <adapter name="EncoderAdapter"
          register-process="true"
          endpoints="tcp">
          <object identity="EncoderFactory1"
            type="::Ripper::MP3EncoderFactory"/>
          </adapter>
        </server>
    </node>
    <node name="Node2">
      <server id="EncoderServer2"
        exe="/opt/ripper/bin/server"
        activation="on-demand">
        <adapter name="EncoderAdapter"
```

```

        register-process="true"
        endpoints="tcp">
        <object identity="EncoderFactory2"
            type="::Ripper::MP3EncoderFactory"/>
    </adapter>
</server>
</node>
</application>
</icegrid>

```

At first glance, the addition of the well-known objects does not appear to simplify our client very much. Rather than selecting which of the two adapters receives the next task, we now need to select one of the well-known objects.

Querying with `findAllObjectsByType`

The `IceGrid::Query` interface provides a way to eliminate the client's dependency on object adapter identifiers and object identities. Since our factories are registered with the same type, we can search for all objects of that type:

```

Ice::ObjectPrx proxy =
    communicator->stringToProxy("IceGrid/Query");
IceGrid::QueryPrx query = IceGrid::QueryPrx::checkedCast(proxy);
Ice::ObjectProxySeq seq;
string type = Ripper::MP3EncoderFactory::ice_staticId();
seq = query->findAllObjectsByType(type);
if (seq.empty()) {
    // no match
}
Ice::ObjectProxySeq::size_type index = ... // random number
Ripper::MP3EncoderFactoryPrx factory =
    Ripper::MP3EncoderFactoryPrx::checkedCast(seq[index]);
Ripper::MP3EncoderPrx encoder = factory->createEncoder();

```

This example invokes `findAllObjectsByType` and then randomly selects an element of the sequence.

Querying with `findObjectByType`

We can simplify the client further using `findObjectByType` instead, which performs the randomization for us:

```

Ice::ObjectPrx proxy =
    communicator->stringToProxy("IceGrid/Query");
IceGrid::QueryPrx query = IceGrid::QueryPrx::checkedCast(proxy);
Ice::ObjectPrx obj;
string type = Ripper::MP3EncoderFactory::ice_staticId();

```

```

obj = query->findObjectByType(type);
if (!obj) {
    // no match
}
Ripper::MP3EncoderFactoryPrx factory =
    Ripper::MP3EncoderFactoryPrx::checkedCast(obj);
Ripper::MP3EncoderPrx encoder = factory->createEncoder();

```

Querying with `findObjectByTypeOnLeastLoadedNode`

So far the use of `IceGrid::Query` has allowed us to simplify our client, but we have not gained any functionality. If we replace the call to `findObjectByType` with `findObjectByTypeOnLeastLoadedNode`, we can improve the client by distributing the encoding tasks more intelligently. The change to the client's code is trivial:

```

Ice::ObjectPrx proxy =
    communicator->stringToProxy("IceGrid/Query");
IceGrid::QueryPrx query = IceGrid::QueryPrx::checkedCast(proxy);
Ice::ObjectPrx obj;
string type = Ripper::MP3EncoderFactory::ice_staticId();
obj = query->findObjectByTypeOnLeastLoadedNode(type,
    IceGrid::LoadSample1);
if (!obj) {
    // no match
}
Ripper::MP3EncoderFactoryPrx factory =
    Ripper::MP3EncoderFactoryPrx::checkedCast(obj);
Ripper::MP3EncoderPrx encoder = factory->createEncoder();

```

Review

Incorporating intelligent load distribution is a worthwhile enhancement and is a capability that would be time consuming to implement ourselves. However, our current design uses only well-known objects in order to make queries possible. We do not really need the encoder factory object on each compute server to be individually addressable as a well-known object, a fact that seems clear when we examine the identities we assigned to them: `EncoderFactory1`, `EncoderFactory2`, and so on. `IceGrid`'s replication features, discussed in Section 37.8, give us the tools we need to improve our design.

37.6 Templates

IceGrid templates simplify the task of creating the descriptors for an application. A template is a parameterized descriptor that you can instantiate as often as necessary. Templates are descriptors in their own right. They are components of an IceGrid application and therefore they are stored in the registry's database. As such, their use is not restricted to XML files; templates can also be created and instantiated interactively using the graphical administration tool (see Section 37.19.2).

You can define templates for server and service descriptors. The focus of this section is server templates; Section 37.7 explains service descriptors and templates.

37.6.1 Server Templates

You may recall from prior sections that the XML description of our sample application defined two nearly identical servers:

```
<icegrid>
  <application name="Ripper">
    <node name="Node1">
      <server id="EncoderServer1"
        exe="/opt/ripper/bin/server"
        activation="on-demand">
        <adapter name="EncoderAdapter"
          register-process="true"
          endpoints="tcp"/>
      </server>
    </node>
    <node name="Node2">
      <server id="EncoderServer2"
        exe="/opt/ripper/bin/server"
        activation="on-demand">
        <adapter name="EncoderAdapter"
          register-process="true"
          endpoints="tcp"/>
      </server>
    </node>
  </application>
</icegrid>
```

This example is an excellent candidate for a server template. Equivalent definitions that incorporate a template are shown below:

```
<icegrid>
  <application name="Ripper">
    <server-template id="EncoderServerTemplate">
      <parameter name="index"/>
      <server id="EncoderServer${index}"
        exe="/opt/ripper/bin/server"
        activation="on-demand">
        <adapter name="EncoderAdapter"
          register-process="true"
          endpoints="tcp"/>
      </server>
    </server-template>
    <node name="Node1">
      <server-instance template="EncoderServerTemplate"
        index="1"/>
    </node>
    <node name="Node2">
      <server-instance template="EncoderServerTemplate"
        index="2"/>
    </node>
  </application>
</icegrid>
```

We have defined a server template named `EncoderServerTemplate`. Nested within the `server-template` element is a `server` element that defines an encoder server. The only difference between this `server` element and our previous example is that it is now parameterized: the template parameter `index` is used to form unique identifiers for the server and its adapter. The symbol `${index}` is replaced with the value of the `index` parameter wherever it occurs.

The template is instantiated by a `server-instance` element, which may be used anywhere that a `server` element is used. The `server-instance` element identifies the template to be instantiated, and supplies a value for the `index` parameter.

Although we have not significantly reduced the length of our XML file, we have made it more readable. And more importantly, deploying this server on additional nodes has become much easier.

37.6.2 Template Parameters

Parameters enable you to customize each instance of a template as necessary. The example in Section 37.6.1 defined the `index` parameter with a different value for

each instance to ensure that identifiers are unique. A parameter may also declare a default value that is used in the template if no value is specified for it. In our sample application the `index` parameter is considered mandatory and therefore should not have a default value, but we can illustrate this feature in another way. For example, suppose that the pathname of the server's executable may change on each node. We can supply a default value for this attribute and override it when necessary:

```
<icegrid>
  <application name="Ripper">
    <server-template id="EncoderServerTemplate">
      <parameter name="index"/>
      <parameter name="exepath"
        default="/opt/ripper/bin/server"/>
      <server id="EncoderServer${index}"
        exe="${exepath}"
        activation="on-demand">
        <adapter name="EncoderAdapter"
          register-process="true"
          endpoints="tcp"/>
      </server>
    </server-template>
    <node name="Node1">
      <server-instance template="EncoderServerTemplate"
        index="1"/>
    </node>
    <node name="Node2">
      <server-instance template="EncoderServerTemplate"
        index="2" exepath="/opt/ripper-test/bin/server"/>
    </node>
  </application>
</icegrid>
```

As you can see, the instance on Node1 uses the default value for the new parameter `exepath`, but the instance on Node2 defines a different location for the server's executable.

For complete details about substitution rules and other semantics, see Section 37.15.

37.6.3 Property Sets

As we saw in the preceding section, template parameters allow you to customize each instance of a server template. Template parameters with default values allow

you to define commonly used configuration options. However, you might want to have additional configuration properties for a given instance without having to add a parameter. For example, to debug a server instance on a specific node, you might want to start the server with the `Ice.Trace.Network` property set; it would be inconvenient to have to add a parameter to the template just to set that property.

To cater for such scenarios, it is possible to specify additional properties for a server instance without modifying the template. You can define such properties in the `server-instance` element, for example:

```
<icegrid>
  <application>
    ...
    <node name="Node2">
      <server-instance template="EncoderServerTemplate"
        index="2">
        <properties>
          <property name="Ice.Trace.Network" value="2"/>
        </properties>
      </server-instance>
    </node>
  </application>
</icegrid>
```

This sets the `Ice.Trace.Network` property for a specific server.

37.6.4 Default Templates

The IceGrid registry can be configured to supply any number of default template descriptors for use in your applications. The configuration property `IceGrid.Registry.DefaultTemplates` specifies the pathname of an XML file containing template definitions. One such template file is provided in the Ice distribution as `config/templates.xml`, which contains helpful templates for deploying Ice services such as `IcePatch2` and `Glacier2`.

The template file must use the structure shown below:

```
<icegrid>
  <application name="DefaultTemplates">
    <server-template id="EncoderServerTemplate">
      ...
    </server-template>
  </application>
</icegrid>
```

The name you give to the application is not important, and you may only define server and service (see Section 37.7.2) templates within it. After configuring the registry to use this file, your default templates become available to every application that imports them.

The descriptor for each application indicates whether the default templates should be imported. (By default they are not imported.) If the templates are imported, they are essentially copied into the application descriptor and treated no differently than templates defined by the application itself. As a result, changes to the file containing default templates have no effect on existing application descriptors. In XML, the attribute `import-default-templates` determines whether the default templates are imported, as shown in the following example:

```
<icegrid>
  <application name="Ripper"
    import-default-templates="true">
    ...
  </application>
</icegrid>
```

37.6.5 Using Templates with `icegridadmin`

The IceGrid administration tools allow you to inspect templates and instantiate new servers dynamically. First, let us ask `icegridadmin` to describe the server template from Section 37.6.1:

```
$ icegridadmin --Ice.Config=/opt/ripper/config
>>> server template describe Ripper \
EncoderServerTemplate
```

This command generates the following output:

```
server template `EncoderServerTemplate'
{
  parameters = `index exepath'
  server `EncoderServer${index}'
  {
    exe = `${exepath}'
    activation = `on-demand'
    properties
    {
      EncoderAdapter.Endpoints = `tcp'
    }
    adapter `EncoderAdapter'
  }
```

```

        id = `EncoderAdapter${index}`
        replica group id = `
        endpoints = `tcp`
        register process = `true`
        wait for activation = `true`
    }
}
}

```

Notice that the server id is a parameterized value; it cannot be evaluated until the template is instantiated with values for its parameters.

Next, we can use `icegridadmin` to create an instance of the encoder server template on a new node:

```

>>> server template instantiate Ripper Node3 \
EncoderServerTemplate index=3

```

The command requires that we identify the application, node and template, as well as supply any parameters needed by the template. The new server instance is permanently added to the registry's database, but if we intend to keep this configuration it is a good idea to update the XML description of our application to reflect these changes and avoid potential synchronization issues.

37.7 IceBox Integration

IceGrid makes it easy to configure an IceBox server (see Chapter 42) with one or more services.

37.7.1 Descriptors

An IceBox server shares many of the same characteristics as other servers, but its special requirements necessitate a new descriptor. Unlike other servers, an IceBox server generally hosts multiple independent services, each requiring its own communicator instance and configuration file.

As an example, the following application deploys an IceBox server containing one service:

```

<icegrid>
  <application name="IceBoxDemo">
    <node name="Node">
      <icebox id="IceBoxServer"

```

```

        exe="/opt/Ice/bin/icebox"
        activation="on-demand">
        <service name="ServiceA" entry="servicea:create">
            <adapter name="\${service}" endpoints="tcp"/>
        </service>
    </icebox>
</node>
</application>
</icegrid>

```

It looks very similar to a server descriptor. The most significant difference is the service descriptor, which is constructed much like a server in that you can declare its attributes such as object adapters and configuration properties. The order in which services are defined determines the order in which they are loaded by the IceBox server.

The value of the adapter's name attribute needs additional explanation. The symbol `service` is one of the names reserved by IceGrid. In the context of a service descriptor, `\${service}` is replaced with the service's name, and so the object adapter is also named `ServiceA`. See Section 37.15.2 for more information on reserved names.

37.7.2 Service Templates

If you are familiar with templates in general (see Section 37.6), an IceBox service template is readily understandable:

```

<icegrid>
  <application name="IceBoxApp">
    <service-template id="ServiceTemplate">
      <parameter name="name"/>
      <service name="\${name}" entry="DemoService:create">
        <adapter name="\${service}"
          register-process="true"
          endpoints="default"/>
        <property name="\${service}.Identity"
          value="\${server}-\${service}"/>
      </service>
    </service-template>
  </application>
  <node name="Node1">
    <icebox id="IceBoxServer" endpoints="default"
      exe="/opt/Ice/bin/icebox" activation="on-demand">
      <service-instance template="ServiceTemplate"
        name="Service1"/>
    </icebox>
  </node>
</icegrid>

```

```

        </icebox>
    </node>
</application>
</icegrid>

```

In this application, an IceBox server is deployed on a node and has one service instantiated from the service template. Of particular interest is the property descriptor, which uses another reserved name `server` to form the property value. When the template is instantiated, the symbol `${server}` is replaced with the name of the enclosing server, so the property definition expands as follows:

```
Service1.Identity=IceBoxServer-Service1
```

See Section 37.15.2 for more information on reserved names.

37.7.3 Advanced Templates

A more sophisticated use of templates involves instantiating a service template in a server template:

```

<icegrid>
  <application name="IceBoxApp">
    <service-template id="ServiceTemplate">
      <parameter name="name"/>
      <service name="${name}" entry="DemoService:create">
        <adapter name="${service}"
          register-process="true"
          endpoints="default"/>
        <property name="${name}.Identity"
          value="${server}-${name}"/>
      </service>
    </service-template>
    <server-template id="ServerTemplate">
      <parameter name="id"/>
      <icebox id="${id}" endpoints="default"
        exe="/opt/Ice/bin/icebox" activation="on-demand">
        <service-instance template="ServiceTemplate"
          name="Service1"/>
      </icebox>
    </server-template>
    <node name="Node1">
      <server-instance template="ServerTemplate"
        id="IceBoxServer"/>
    </node>
  </application>
</icegrid>

```

This application is equivalent to the definition from Section 37.7.2. Now, however, the process of deploying an identical server on several nodes has become much simpler.

37.8 Replication

As an implementation of an Ice location service, IceGrid supports replication as described on page 14. An application defines its replica groups and their participating object adapters using descriptors, and IceGrid generates the server configurations automatically.

37.8.1 Replica Group Descriptor

The descriptor that defines a replica group can optionally declare well-known objects as well as configure the group to determine its behavior during locate requests. Consider this example:

```
<icegrid>
  <application name="ReplicaApp">
    <replica-group id="ReplicatedAdapter">
      <object identity="TheObject"
        type="::Demo::ObjectType"/>
    </replica-group>
    <node name="Node">
      <server id="ReplicaServer" activation="on-demand"
        exe="/opt/replica/bin/server">
        <adapter name="TheAdapter" endpoints="default"
          replica-group="ReplicatedAdapter"/>
      </server>
    </node>
  </application>
</icegrid>
```

The adapter's descriptor declares itself to be a member of the replica group `ReplicatedAdapter`, which must have been previously created by a replica group descriptor.

The replica group `ReplicatedAdapter` declares a well-known object so that an indirect proxy of the form `TheObject` is equivalent to the indirect proxy `TheObject@ReplicatedAdapter`. Since this trivial example defines only one adapter in the replica group, the proxy `TheObject` is also equivalent to `TheObject@TheAdapter`.

37.8.2 Replica Group Membership

An object adapter participates in a replica group by specifying the group's id in the adapter's `ReplicaGroupId` configuration property. Identifying the replica group in the IceGrid descriptor for an object adapter causes the node to include the equivalent `ReplicaGroupId` property in the configuration file it generates for the server.

By default, the IceGrid registry requires the membership of a replica group to be statically defined. When you create a descriptor for an object adapter that identifies a replica group, the registry adds that adapter to the group's list of valid members. During an adapter's activation, when it describes its endpoints to the registry, an adapter that also claims membership in a replica group is validated against the registry's internal list.

In a properly configured IceGrid application, this activity occurs without incident, but there are situations in which validation can fail. For example, adapter activation fails if an adapter's id is changed without notifying the registry, such as by manually modifying the server configuration file that was generated by a node.

It is also possible for activation to fail when the IceGrid registry is being used solely as a location service, in which case descriptors have not been created and therefore the registry has no advance knowledge of the replica groups or their members. In this situation, adapter activation causes the server to receive `NotRegisteredException` unless the registry is configured to allow dynamic registration, which you can do by defining the following property:

```
IceGrid.Registry.DynamicRegistration=1
```

With this configuration, a replica group is created implicitly as soon as an adapter declares membership in it, and any adapter is allowed to participate.

The use of dynamic registration often leads to the accumulation of obsolete replica groups and adapters in the registry. The IceGrid administration tools (see Section 37.19) allow you to inspect and clean up the registry's state.

37.8.3 Application Changes

Replication is a perfect fit for the ripper application. The collection of encoder factory objects should be treated as a single logical object, and replication makes that possible.

Descriptors

Adding a replica group descriptor to our application is very straightforward:

```

<icegrid>
  <application name="Ripper">
    <replica-group id="EncoderAdapters">
      <object identity="EncoderFactory"
        type="::Ripper::MP3EncoderFactory"/>
    </replica-group>
    <server-template id="EncoderServerTemplate">
      <parameter name="index"/>
      <parameter name="exepath"
        default="/opt/ripper/bin/server"/>
      <server id="EncoderServer${index}"
        exe="${exepath}"
        activation="on-demand">
        <adapter name="EncoderAdapter"
          replica-group="EncoderAdapters"
          register-process="true"
          endpoints="tcp"/>
      </server>
    </server-template>
    <node name="Node1">
      <server-instance template="EncoderServerTemplate"
        index="1"/>
    </node>
    <node name="Node2">
      <server-instance template="EncoderServerTemplate"
        index="2"/>
    </node>
  </application>
</icegrid>

```

The new descriptor adds the replica group called `EncoderAdapters` and registers a well-known object with the identity `EncoderFactory`. The adapter descriptor in the server template has been changed to declare its membership in the replica group.

Client

In comparison to the examples from Section 37.5.6 that used queries, the new version of our client has become much simpler:

```

Ice::ObjectPrx obj =
    communicator->stringToProxy("EncoderFactory");
Ripper::MP3EncoderFactoryPrx factory =
    Ripper::MP3EncoderFactoryPrx::checkedCast(obj);
Ripper::MP3EncoderPrx encoder = factory->createEncoder();

```

The client no longer needs to use the `IceGrid::Query` interface, but simply creates a proxy for a well-known object and lets the Ice run time transparently interact with the location service. In response to a locate request for `EncoderFactory`, the registry returns a proxy containing the endpoints of both object adapters. The Ice run time in the client selects one of the endpoints at random, meaning we have now lost some functionality compared to the prior example in which system load was considered when selecting an endpoint. We will learn how to rectify this situation in Section 37.9.

37.9 Load Balancing

Replication is an important IceGrid feature but, when combined with load balancing, replication becomes even more useful.

IceGrid nodes regularly report the system load of their hosts to the registry. A replica group's configuration determines whether the registry considers system loads when deciding which endpoint(s) to return to a client in response to a locate request.

IceGrid's load balancing capability assists the client in selecting an initial endpoint for a connection. As discussed in Section 31.17.2, once a client has established a connection, all subsequent requests on the proxy that initiated the connection are sent to the same server without further consideration for load balancing.

37.9.1 Configuring a Replica Group

A replica group descriptor optionally contains a load balancing descriptor that determines how system loads are used in locate requests. The load balancing descriptor specifies the following information:

- **Type**
Several types of load balancing are supported. See Section 37.9.2 for details.
- **Sampling interval**
One of the load balancing types considers system load statistics, which are reported by each node at regular intervals. The replica group can specify a sampling interval of one, five, or fifteen minutes. Choosing a sampling interval requires balancing the need for up-to-date load information against the desire to minimize transient spikes.

- Number of replicas

The replica group can instruct the registry to return the endpoints of one (the default) or more object adapters. If the specified number N is larger than one, the proxy returned in response to a locate request contains the endpoints of at most N object adapters. The Ice run time in the client selects one of these endpoints at random (see Section 31.10.3).

For example, the descriptor shown below uses adaptive load balancing to return the endpoints of the two least-loaded object adapters sampled with five-minute intervals:

```
<replica-group id="ReplicatedAdapter">
  <load-balancing type="adaptive" load-sample="5"
    n-replicas="2"/>
</replica-group>
```

The type must be specified, but the remaining attributes are optional.

37.9.2 Load Balancing Types

A replica group can select one of the following load balancing types.

None

If no load balancing is requested, a locate request receives the endpoints of all object adapters in the group. The registry does not consider system load in this case.

Random

Random load balancing selects the requested number of object adapters at random. The registry does not consider system load for a replica group with this type.

Adaptive

Adaptive load balancing uses system load information to choose the least-loaded object adapters over the requested sampling interval. This is the only load balancing type that uses sampling intervals.

Round Robin

Round robin load balancing returns the least recently used object adapters. The registry does not consider system load for a replica group with this type.

37.9.3 Application Changes

The only change we need to make to the ripper application is the addition of a load balancing descriptor:

```
<icegrid>
  <application name="Ripper">
    <replica-group id="EncoderAdapters">
      <load-balancing type="adaptive"/>
      <object identity="EncoderFactory"
        type="::Ripper::MP3EncoderFactory"/>
    </replica-group>
    <server-template id="EncoderServerTemplate">
      <parameter name="index"/>
      <parameter name="exepath"
        default="/opt/ripper/bin/server"/>
      <server id="EncoderServer${index}"
        exe="${exepath}"
        activation="on-demand">
        <adapter name="EncoderAdapter"
          replica-group="EncoderAdapters"
          register-process="true"
          endpoints="tcp"/>
      </server>
    </server-template>
    <node name="Node1">
      <server-instance template="EncoderServerTemplate"
        index="1"/>
    </node>
    <node name="Node2">
      <server-instance template="EncoderServerTemplate"
        index="2"/>
    </node>
  </application>
</icegrid>
```

Using adaptive load balancing, we have regained the functionality we forfeited in Section 37.8.3. Namely, we now select the object adapter on the least-loaded node, and no changes were necessary in the client.

37.10 Sessions

IceGrid provides a resource allocation facility that coordinates access to the objects and servers of an IceGrid application. To allocate a resource for exclusive

use, a client must first establish a session by authenticating itself with the IceGrid registry or a Glacier2 router, after which the client may reserve objects and servers that the application indicates are allocatable. The client should release the resource when it is no longer needed, otherwise IceGrid reclaims it when the client's session terminates or expires due to inactivity.

An allocatable server offers at least one allocatable object. The server is considered to be allocated when its first allocatable object is claimed, and is not released until all of its allocated objects are released. While the server is allocated by a client, no other clients can allocate its objects.

37.10.1 Creating a Session

A client must create an IceGrid session before it can allocate objects. If you have configured a Glacier2 router to use IceGrid's session managers (see Section 37.13), the client's router session satisfies this requirement. For more information on creating a Glacier2 session, see Section 41.3.6.

In the absence of Glacier2, an IceGrid client invokes `createSession` or `createSessionFromSecureConnection` on IceGrid's `Registry` interface to create a session:

```
module IceGrid {
    exception PermissionDeniedException {
        string reason;
    };

    interface Registry {
        Session* createSession(string userId, string password)
            throws PermissionDeniedException;

        Session* createSessionFromSecureConnection()
            throws PermissionDeniedException;

        nonmutating int getSessionTimeout();
    };
};
```

The `createSession` operation expects a username and password and returns a session proxy if the client is allowed to create a session. By default, IceGrid does not allow the creation of sessions. You must define the registry property `IceGrid.Registry.PermissionsVerifier` with the proxy of a permissions verifier object to enable session creation with `createSession` (see Section 37.10.2).

The `createSessionFromSecureConnection` operation does not require a username and password because it uses the credentials supplied by an SSL connection to authenticate the client (see Chapter 40). As with `createSession`, you must configure the proxy of a permissions verifier object before clients can use `createSessionFromSecureConnection` to create a session. In this case, the property is `IceGrid.Registry.SSLPermissionsVerifier` (see Section 37.10.2).

To create a session, the client obtains the registry proxy by converting the well-known proxy string `"IceGrid/Registry"` to a proxy object with the communicator, downcasts the proxy to the `IceGrid::Registry` interface, and invokes on one of the operations. The sample code below demonstrates how to do it in C++; the code will look very similar in other language mappings.

```
Ice::ObjectPrx base =
    communicator->stringToProxy("IceGrid/Registry");
IceGrid::RegistryPrx registry =
    IceGrid::RegistryPrx::checkedCast(base);
string username = ...;
string password = ...;
IceGrid::SessionPrx session;
try {
    session = registry->createSession(username, password);
} catch (const IceGrid::PermissionDeniedException & ex) {
    cout << "permission denied:\n" << ex.reason << endl;
}
```

After creating the session, the client must keep it alive by periodically invoking its `keepAlive` operation. The session expires if the client does not invoke `keepAlive` within the configured timeout period, which can be obtained by calling the `getSessionTimeout` operation on the `Registry` interface.

If a session times out, or if the client explicitly terminates the session by invoking its `destroy` operation, IceGrid automatically releases all objects allocated using that session.

37.10.2 Access Control

As described in Section 37.10.1 above, you must configure the IceGrid registry with the proxy of at least one permissions verifier object to enable session creation:

- `IceGrid.Registry.PermissionsVerifier`
This property supplies the proxy of an object that implements the interface `Glacier2::PermissionsVerifier`. Defining this property allows clients to create sessions using `createSession`.
- `IceGrid.Registry.SSLPermissionsVerifier`
This property supplies the proxy of an object that implements the interface `Glacier2::SSLPermissionsVerifier`. Defining this property allows clients to create sessions using `createSessionFromSecureConnection`.

IceGrid supplies built-in permissions verifier objects:

- A null permissions verifier for TCP/IP. This object accepts any username and password and should only be used in a secure environment where no access control is necessary. You select this verifier object by defining the following configuration property:

```
IceGrid.Registry.PermissionsVerifier=\
    IceGrid/NullPermissionsVerifier
```

- A null permissions verifier for SSL, analogous to the one for TCP/IP. You select this verifier object by defining the following configuration property:

```
IceGrid.Registry.SSLPermissionsVerifier=\
    IceGrid/NullSSLPermissionsVerifier
```

- A file-based permissions verifier. This object uses an access control list in a file that contains username-password pairs. The format of the password file is the same as the format of Glacier2 password files described in Section 41.3.2. You enable this verifier implementation by defining the configuration property `IceGrid.Registry.CryptPasswords` with the pathname of the password file. Note that this property is ignored if you specify the proxy of a permissions verifier object using `IceGrid.Registry.PermissionsVerifier`.

If you decide to implement your own permissions verifier object, Section 41.5.1 describes the Glacier2 interfaces in detail.

37.10.3 Allocating Objects

A client allocates objects using the session proxy returned from `createSession` or `createSessionFromSecureConnection`. The proxy supports the `Session` interface shown below:

```
module IceGrid {
    exception ObjectNotRegisteredException {
        Ice::Identity id;
    };

    exception AllocationException {
        string reason;
    };

    exception AllocationTimeoutException
        extends AllocationException {
    };

    interface Session extends Glacier2::Session {

        idempotent void keepAlive();

        Object* allocateObjectById(Ice::Identity id)
            throws ObjectNotRegisteredException,
                AllocationException;

        Object* allocateObjectByType(string type)
            throws AllocationException;

        void releaseObject(Ice::Identity id)
            throws ObjectNotRegisteredException,
                AllocationException;

        idempotent void setAllocationTimeout(int timeout);
    };
};
```

The client is responsible for keeping the session alive by periodically invoking `keepAlive`, as discussed in Section 37.10.1.

The `allocateObjectById` operation allocates and returns the proxy for the allocatable object with the given identity. If no allocatable object with the given identity is registered, the client receives `ObjectNotRegisteredException`. If the object cannot be allocated, the client receives `AllocationException`. An allocation attempt can fail for the following reasons:

- the object is already allocated by the session
- the object is allocated by another session and did not become available during the configured allocation timeout period
- the session was destroyed.

The `allocateObjectByType` operation allocates and returns a proxy for an allocatable object registered with the given type. If more than one allocatable object is registered with the given type, the registry selects one at random. The client receives `AllocationException` if no objects with the given type could be allocated. An allocation attempt can fail for the following reasons:

- no objects are registered with the given type
- all objects with the given type are already allocated (either by this session or other sessions) and none became available during the configured allocation timeout period
- the session was destroyed.

The `releaseObject` operation releases an object allocated by the session. The client receives `ObjectNotRegisteredException` if no allocatable object is registered with the given identity and `AllocationException` if the object is not allocated by the session. Upon session destruction, IceGrid automatically releases all allocated objects.

The `setAllocationTimeout` operation configures the timeout used by the allocation operations. If no allocatable objects are available when the client invokes `allocateObjectById` or `allocateObjectByType`, IceGrid waits for the specified timeout period for an allocatable object to become available. If the timeout expires, the client receives `AllocationTimeoutException`.

37.10.4 Allocating Servers

A client does not need to explicitly allocate a server. If a server is allocatable, IceGrid implicitly allocates it to the first client that claims one of the server's allocatable objects. Likewise, IceGrid releases the server when all of its allocatable objects are released.

Server allocation is useful in two situations:

- Only allocatable servers can use the `session` activation mode, in which the server is activated on demand when allocated by a client and deactivated upon release.
- An allocatable server can be secured with IceSSL or Glacier2 so that its objects can only be invoked by the client that allocated it.

37.10.5 Security

IceGrid's resource allocation facility allows clients to coordinate access to objects and servers but does not place any restrictions on client invocations to allocated objects; any client that has a proxy for an allocated object could conceivably invoke an operation on it. IceGrid assumes that clients are cooperating with each other and respecting allocation semantics.

To prevent unauthorized clients from invoking operations on an allocated object or server, you can use IceSSL or Glacier2:

- Using IceSSL, you can secure access to a server or a particular object adapter with the properties `IceSSL.TrustOnly.Server` or `IceSSL.TrustOnly.Server.AdapterName`.

For example, if you configure a server with the session activation mode, you can set one of the `IceSSL.TrustOnly` property to the `${session.id}` variable, which is substituted with the session id when the server is activated for the session. If the IceGrid session was created from a secure connection, the session id will be the distinguished name associated with the secure connection, which effectively restricts access to the server or one of its adapters to the client that established the session with IceGrid.

- With Glacier2, you can secure access to an allocated object or the object adapters of an allocated server with the Glacier2 filtering mechanism (see Section 41.5.2). By default, IceGrid sessions created with a Glacier2 router are automatically given access to allocated objects as well as the object adapters of allocated servers. See Section 37.13 for more information.

37.10.6 Descriptors

Allocatable objects are registered using a descriptor that is similar to well-known object descriptors (see Section Section 37.14.13). Allocatable objects cannot be replicated and therefore can only be specified within an object adapter descriptor.

Servers can be specified as allocatable by setting the server descriptor's `allocatable` attribute.

As an example, the following application defines an allocatable server and an allocatable object:

```
<icegrid>
  <application name="Ripper">
    <node name="Node1">
      <server id="EncoderServer"
        exe="/opt/ripper/bin/server"
```

```

        activation="on-demand"
        allocatable="true">
        <adapter name="EncoderAdapter"
            id="EncoderAdapter"
            register-process="true"
            endpoints="tcp">
            <allocatable identity="EncoderFactory"
                type="::Ripper::MP3EncoderFactory"/>
        </adapter>
    </server>
</node>
</application>
</icegrid>

```

37.10.7 Application Changes

We can use the allocation facility in our MP3 encoder factory to coordinate access to the MP3 encoder factories. First we need to modify the descriptors to define an allocatable object:

```

<icegrid>
  <application name="Ripper">
    <server-template id="EncoderServerTemplate">
      <parameter name="index"/>
      <server id="EncoderServer${index}"
          exe="/opt/ripper/bin/server"
          activation="on-demand">
        <adapter name="EncoderAdapter"
            register-process="true"
            endpoints="tcp">
          <allocatable identity="EncoderFactory${index}"
              type="::Ripper::MP3EncoderFactory"/>
        </adapter>
      </server>
    </server-template>
    <node name="Node1">
      <server-instance template="EncoderServerTemplate"
          index="1"/>
    </node>
    <node name="Node2">
      <server-instance template="EncoderServerTemplate"
          index="2"/>
    </node>
  </application>
</icegrid>

```

Next, the client needs to create a session and allocate a factory:

```
Ice::ObjectPrx obj = session->allocateObjectByType(
    Ripper::MP3EncoderFactory::ice_staticId());
try {
    Ripper::MP3EncoderPrx encoder = factory->createEncoder();
    // Use the encoder to encode a file ...
}
catch (const Ice::LocalException & ex) {
    // There was a problem with the encoding, we catch the
    // exception to make sure we release the factory.
}
session->releaseObject(obj->ice_getIdentity());
```

It is important to release an allocated object when it is no longer needed so that other clients may use it. If you forget to release an object, it remains allocated until the session is destroyed.

37.11 Application Distribution

In the chapter so far, “deployment” has meant the creation of descriptors in the registry. A broader definition involves a number of other tasks:

- Writing IceGrid configuration files and preparing data directories on each computer
- Installing the IceGrid binaries and dependent libraries on each computer
- Starting the registry and/or node on each computer, and possibly configuring the systems to launch them automatically
- Distributing your server executables, dependent libraries and supporting files to the appropriate nodes.

The first three tasks are the responsibility of the system administrator, but IceGrid can help with the fourth. Using an IcePatch2 server (see Chapter 44), you can

configure the nodes to download servers automatically and patch them at any time. Figure 37.5 shows the interactions of the components.

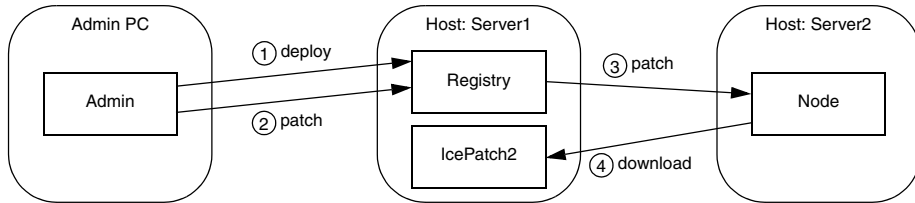

Figure 37.5. Overview of application distribution.

As you can see, deploying an IceGrid application has greater significance when IcePatch2 is also involved. After deployment, the administrative tool initiates a patch, causing the registry to notify all active nodes that are configured for application distribution to begin the patching process. Since each IceGrid node is an IcePatch2 client, the node performs the patch just like any IcePatch2 client: it downloads everything if no local copy of the distribution exists, otherwise it does an incremental patch in which it downloads only new files and those whose signatures have changed.

The benefits of this feature are clear:

- The distribution files are maintained in a central location
- Updating a distribution on all of the nodes is a simple matter of preparing the master distribution and letting IceGrid do the rest
- Manually transferring executables and supporting files to each computer is avoided, along with the mistakes that manual intervention sometimes introduces.

37.11.1 Deploying an IcePatch2 Server

If you plan to use IceGrid's distribution capabilities, we generally recommend deploying an IcePatch2 server along with your application. Doing so gives you the same benefits as any other IceGrid server, including on-demand activation and remote administration. We'll only use one server in our sample application, but you might consider replicating a number of IcePatch2 servers in order to balance the patching load for large distributions.

Patching Considerations

Deploying an IcePatch2 server with your application presents a chicken-and-egg dilemma: how do the nodes download their distributions if the IcePatch2 server is included in the deployment? To answer this question, we need to learn more about IceGrid's behavior.

Deploying and patching are treated as two separate steps: first you deploy the application, then you initiate the patching process. The `icegridadmin` utility combines these steps into one command (`application add`), but also provides an option to disable the patching step if so desired.

Let's consider the state of the application after deployment but before patching: we have described the servers that run on each node, including file-system-dependent attributes such as the pathnames of their executables and default working directories. If these pathnames refer to directories in the distribution, and the distribution has not yet been downloaded to that node, then clearly we cannot attempt to use those servers until patching has completed. Similarly, we cannot deploy an IcePatch2 server whose executable resides in the distribution to be downloaded².

For these reasons, we assume that the IcePatch2 server and supporting libraries are distributed by the system administrator along with the IceGrid registry and nodes to the appropriate computers. The server should be configured for on-demand activation so that its node starts it automatically when patching begins. If the server is configured for manual activation, you must start it prior to patching.

Server Template

The Ice distribution includes an IcePatch2 server template that simplifies the inclusion of IcePatch2 in your application. The relevant portion from the file `config/templates.xml` is shown below:

```
<server-template id="IcePatch2">
  <parameter name="instance-name"
    default="\${application}.IcePatch2"/>
  <parameter name="endpoints" default="default"/>
  <parameter name="directory"/>

  <server id="\${instance-name}" exe="icepatch2server"
```

2. We are ignoring the case where a temporary IcePatch2 server is used to bootstrap other IcePatch2 servers.

```

application-distrib="false" activation="on-demand">
<adapter name="IcePatch2" endpoints="{endpoints}">
  <object identity="{instance-name}/server"
    type="::IcePatch2::FileServer"/>
</adapter>
<adapter name="IcePatch2.Admin" id=""
  endpoints="tcp -h 127.0.0.1" register-process="true"/>
<property name="IcePatch2.InstanceName"
  value="{instance-name}"/>
<property name="IcePatch2.Directory"
  value="{directory}"/>
</server>
</server-template>

```

Notice that the server's pathname is `icepatch2server`, meaning the program must be present in the node's executable search path. The only mandatory parameter is `directory`, which specifies the server's data directory and becomes the value of the `IcePatch2.Directory` property. The value of the `instance-name` parameter is used as the server's identifier when the template is instantiated; its default value includes the name of the application in which the template is used. This identifier also affects the identities of the two well-known objects declared by the server (see Section 44.6).

Consider the following sample application:

```

<icegrid>
  <application name="PatchDemo">
    <node name="Node">
      <server-instance template="IcePatch2"
        directory="/opt/icepatch2/data"/>
      ...
    </node>
  </application>
</icegrid>

```

Instantiating the `IcePatch2` template creates a server identified as `PatchDemo.IcePatch2` (as determined by the default value for the `instance-name` parameter). The well-known objects use this value as the category in their identities, such as `PatchDemo.IcePatch2/server`.

In order to refer to the `IcePatch2` template in your application, you must have already configured the registry to use the `config/templates.xml` file as your default templates (see Section 37.6.4), or copied the template into the XML file describing your application.

37.11.2 Distribution Descriptor

A distribution descriptor provides the details that a node requires in order to download the necessary files. Specifically, the descriptor supplies the proxy of the IcePatch2 server and the names of the subdirectories comprising the distribution, all of which are optional. If the descriptor does not define the proxy, the following default value is used instead:

```
${application}.IcePatch2/server
```

You may recall that this value matches the default identity configured by the IcePatch2 server template described in Section 37.11.1. Also notice that this is an indirect proxy, implying that the IcePatch2 server was deployed with the application and can be started on-demand if necessary.

If the descriptor does not select any subdirectories, the node downloads the entire contents of the IcePatch2 data directory.

In XML, a descriptor having the default behavior as described above can be written as shown below:

```
<distrib/>
```

To specify a proxy, use the `icepatch` attribute:

```
<distrib icepatch="PatchDemo.IcePatch2/server"/>
```

Finally, select subdirectories using a nested element:

```
<distrib>
  <directory>dir1</directory>
  <directory>dir2/subdir</directory>
</distrib>
```

By including only certain subdirectories in a distribution, you are minimizing the time and effort required to download and patch each node. For example, each node in a heterogeneous network might download a platform-specific subdirectory and another subdirectory containing files common to all platforms.

37.11.3 Application and Server Distributions

A distribution descriptor can be used in two contexts: within an application, and within a server. When the descriptor appears at the application level, it means every node in the application downloads that distribution. This is useful for distributing files required by all of the nodes on which servers are deployed, especially in a grid of homogeneous computers where it would be tedious to repeat the

same distribution information in each server descriptor. Here is a simple XML example:

```
<icegrid>
  <application name="PatchDemo">
    <distrib>
      <directory>Common</directory>
    </distrib>
    ...
  </application>
</icegrid>
```

At the server level, a distribution descriptor downloads the specified directories for the private use of the server:

```
<icegrid>
  <application name="PatchDemo">
    <distrib>
      <directory>Common</directory>
    </distrib>
    <node name="Node">
      <server id="SimpleServer" ...>
        <distrib>
          <directory>ServerFiles</directory>
        </distrib>
      </server>
    </node>
  </application>
</icegrid>
```

When a distribution descriptor is defined at both the application and server levels, as shown in the previous example, IceGrid assumes that a dependency relationship exists between the two unless the server is configured otherwise. IceGrid checks this dependency before patching a server; if the server is dependent on the application's distribution, IceGrid patches the application's distribution first, and then proceeds to patch the server's. You can disable this dependency by modifying the server's descriptor:

```
<icegrid>
  <application name="PatchDemo">
    <distrib>
      <directory>Common</directory>
    </distrib>
    <node name="Node">
      <server id="SimpleServer" application-distrib="false"
        ...>
```

```

        <distrib>
            <directory>ServerFiles</directory>
        </distrib>
    </server>
</node>
</application>
</icegrid>

```

Setting the `application-distrib` attribute to `false` informs IceGrid to consider the two distributions independent of one another.

37.11.4 Server Integrity

Before an IceGrid node begins patching a distribution, it ensures that all relevant servers are shut down and prevents them from reactivating until patching completes. For example, the node disables all of the servers whose descriptors declare a dependency on the application distribution (see Section 37.11.3).

37.11.5 Using Distributions

The node stores application and server distributions in its data directory. The pathnames of the distributions are represented by reserved variables that you can use in your descriptors:

- `application.distrib`

This variable can be used within server descriptors to refer to the top-level directory of the application distribution.

- `server.distrib`

The value of this variable is the top-level directory of a server distribution. It can be used only within a server descriptor that has a distribution.

The XML example shown below illustrates the use of these variables:

```

<icegrid>
  <application name="PatchDemo">
    <distrib>
      <directory>Common</directory>
    </distrib>
  <node name="Node">
    <server id="Server1"
      exe="{application.distrib}/Common/Bin/Server1"
      ...>
    </server>
  </node>
</application>
</icegrid>

```

```

        <server id="Server2"
            exe="${server.distrib}/Server2Files/Bin/Server2"
            ...>
        <option>-d</option>
        <option>${server.distrib}/Server2Files</option>
        <distrib>
            <directory>Server2Files</directory>
        </distrib>
    </server>
</node>
</application>
</icegrid>

```

Notice that the descriptor for `Server2` supplies the server's distribution directory as command-line options.

For more information on variables, see Section 37.15.

37.11.6 Application Changes

Adding an application distribution to our ripper example requires two minor changes to our descriptors from Section 37.8.3:

```

<icegrid>
  <application name="Ripper">
    <replica-group id="EncoderAdapters">
      <load-balancing type="adaptive"/>
      <object identity="EncoderFactory"
        type="::Ripper::MP3EncoderFactory"/>
    </replica-group>
    <server-template id="EncoderServerTemplate">
      <parameter name="index"/>
      <parameter name="exepath"
        default="/opt/ripper/bin/server"/>
      <server id="EncoderServer${index}"
        exe="${exepath}"
        activation="on-demand">
        <adapter name="EncoderAdapter"
          replica-group="EncoderAdapters"
          register-process="true"
          endpoints="tcp"/>
      </server>
    </server-template>
  </distrib/>
  <node name="Node1">
    <server-instance template="EncoderServerTemplate"

```

```

        index="1"/>
    <server-instance template="IcePatch2"
        directory="/opt/ripper/icepatch"/>
</node>
<node name="Node2">
    <server-instance template="EncoderServerTemplate"
        index="2"/>
</node>
</application>
</icegrid>

```

An application distribution is sufficient for this example because we are deploying the same server on each node. We have also deployed an IcePatch2 server on Node1 using the template described in Section 37.11.1.

37.12 Dynamic Monitoring

IceGrid allows an application to monitor relevant state changes by registering callback objects. (The IceGrid GUI tool uses these callback interfaces for its implementation.) The callback interfaces are useful to, for example, automatically generate an email notification when a node goes down or some other state change of interest occurs.

37.12.1 The Observer Interfaces

IceGrid supports two such callback interfaces, `NodeObserver` and `RegistryObserver`:

```

module IceGrid {
interface NodeObserver {
    void init(NodeDynamicInfoSeq nodes);
    void nodeUp(NodeDynamicInfo node);
    void nodeDown(string name);
    void updateServer(string node, ServerDynamicInfo updatedInfo);
    void updateAdapter(string node,
        AdapterDynamicInfo updatedInfo);
};

interface RegistryObserver
{
    void init(int serial, ApplicationDescriptorSeq applications,
        AdapterInfoSeq adpts, ObjectInfoSeq objects);
};

```

```

void applicationAdded(int serial, ApplicationDescriptor desc);
void applicationRemoved(int serial, string name);
void applicationUpdated(int serial,
                        ApplicationUpdateDescriptor desc);
void adapterAdded(int serial, AdapterInfo info);
void adapterUpdated(int serial, AdapterInfo info);
void adapterRemoved(int serial, string id);
void objectAdded(int serial, ObjectInfo info);
void objectUpdated(int serial, ObjectInfo info);
void objectRemoved(int serial, Ice::Identity id);
};

};

```

The NodeObserver interface is notified of state changes that happen at run time (such as a node coming up or going down), whereas the RegistryObserver interface is notified of updates to the registry database (such as an application being added).

37.12.2 Creating an Administrative Session

To receive notification of state changes, you need to establish an administrative session with the registry and install your observers. The Registry interface provides two operations for creating an administrative session:

```

module IceGrid {
    exception PermissionDeniedException {
        string reason;
    };

    interface Registry {
        AdminSession* createAdminSession(string userId,
                                         string password)
            throws PermissionDeniedException;

        AdminSession* createAdminSessionFromSecureConnection()
            throws PermissionDeniedException;

        nonmutating int getSessionTimeout();

        // ...
    };
};

```

The `createAdminSession` operation expects a username and password and returns a session proxy if the client is allowed to create a session. By default, IceGrid does not allow the creation of administrative sessions. You must define the property `IceGrid.Registry.AdminPermissionsVerifier` with the proxy of a permissions verifier object to enable session creation with `createAdminSession`. The verifier object must implement the interface `Glacier2::PermissionsVerifier` (see Section 41.5.1).

The `createAdminSessionFromSecureConnection` operation does not require a username and password because it uses the credentials supplied by an SSL connection to authenticate the client (see Chapter 40). As with `createAdminSession`, you must configure the proxy of a permissions verifier object before clients can use `createAdminSessionFromSecureConnection` to create a session. In this case, the `IceGrid.Registry.AdminSSLPermissionsVerifier` property specifies the proxy of a verifier object that implements the interface `Glacier2::SSLPermissionsVerifier` (see Section 41.5.1).

The session creation functions are very similar to those for allocating objects. Refer to Section 37.10.1 for an example of accessing the registry, and Section 37.10.2 for details on access control.

Use caution when enabling these session operations. As you can see from the definition of `AdminSession` in the next section, a client that successfully creates a session is able to obtain a proxy for the `IceGrid::Admin` object and gain complete access to your registry.

37.12.3 Registering Observers

The `AdminSession` interface provides two operations for registering your observers:

```
module IceGrid {
    interface AdminSession extends Glacier2::Session {
        idempotent void keepAlive();

        nonmutating Admin* getAdmin();

        idempotent void setObservers(
            RegistryObserver* registryObs,
            NodeObserver* nodeObs);

        idempotent void setObserversByIdentity(
            Ice::Identity registryObs,
            Ice::Identity nodeObs);
    }
}
```

```
        // ...  
    };  
};
```

You should invoke `setObservers` and supply proxies when it is possible for the registry to establish a separate connection to the client to deliver its callbacks. If network restrictions such as firewalls prevent such a connection, you should use the `setObserversByIdentity` operation, which creates a bi-directional connection instead (see Section 35.7).

You can pass a null proxy for either parameter to `setObservers`, or an empty identity for either parameter to `setObserversByIdentity`, if you want to use only one of the two observers. In addition, passing a null proxy or an empty identity for an observer cancels a previous registration of that observer.

Once the observers are registered, operations corresponding to state changes will be invoked on the observers. (See Appendix B for details on the data passed to the observers. You can also look at the source code for the IceGrid GUI implementation in the Ice for Java distribution to see how observers are used by the GUI.)

You are responsible for preventing the administrative session from expiring by invoking `keepAlive` periodically. You can determine the timeout period by calling `getSessionTimeout` on the `Registry` interface (see Section 37.12.2).

37.13 Glacier2 Integration

This section provides information on integrating a Glacier2 router (see Chapter 41) into your IceGrid environment.

37.13.1 Configuration Requirements

A typical IceGrid client must be configured with a locator proxy (see Section 37.4.4), but the configuration requirements change when the client

accesses the location service indirectly via a Glacier2 router as shown in Figure 37.6.

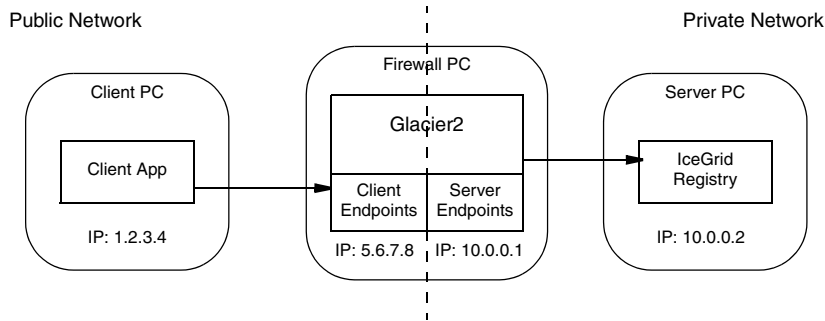

Figure 37.6. Using IceGrid via a Glacier2 router.

In this situation, it is the router that must be configured with a locator proxy.

Assuming the registry's client endpoint in Figure 37.6 uses port 8000, the router requires the following configuration property:

```
Ice.Default.Locator=IceGrid/Locator:tcp -h 10.0.0.2 -p 8000
```

Fortunately, the node supplies this property when it starts the router, so there is no need to configure it explicitly. Note that all of the router's clients use the same locator.

37.13.2 Remote Administration

If you intend to administer IceGrid remotely via a Glacier2 router, you must define one of the following properties (or both), depending on whether you use user name and password authentication or a secure connection:

```
Glacier2.SessionManager=IceGrid/AdminSessionManager
Glacier2.SSLSessionManager=IceGrid/AdminSSLSessionManager
```

These session managers are accessible via the administrative endpoints, so the Glacier2 router must be authorized to establish a connection to these endpoints. Note that you must secure these endpoints, otherwise arbitrary clients can manipulate the session managers. An administrative session is only allowed to access the `IceGrid::AdminSession` object and the `IceGrid::Admin` object that is returned by the session's `getAdmin` operation.

37.13.3 Allocating Servers and Objects

To allocate servers and objects, a client can establish a client session via Glacier2. Depending on the authentication method, one or both of the following properties must be set in the Glacier2 configuration:

```
Glacier2.SessionManager=IceGrid/SessionManager
Glacier2.SSLSessionManager=IceGrid/SSLSessionManager
```

Like the administrative session managers, these session managers are accessible via the administrative endpoints, so the Glacier2 router must be authorized to establish a connection to these endpoints.

A client session is allowed to access only the `IceGrid::Session` and `IceGrid::Query` objects. However, you can use the allocation mechanism to access more objects and adapters. IceGrid adds an identity filter when a client allocates an object and removes that filter again when the object is released. When a client allocates a server, IceGrid adds an adapter identity filter for the server's indirect adapters and removes that filter again when the server is released.

37.13.4 Deploying a Router

The Ice distribution includes default server templates for Ice services such as IcePatch2 (see Section 37.11.1) and Glacier2 that simplify the task of deploying these servers in an IceGrid domain.

The relevant portion from the file `config/template.xml` is shown below:

```
<server-template id="Glacier2">
  <parameter name="instance-name"
             default="\${application}.Glacier2"/>
  <parameter name="client-endpoints"/>
  <parameter name="server-endpoints"/>
  <parameter name="session-timeout" default="0"/>

  <server id="\${instance-name}" exe="glacier2router">
  <properties>
    <property name="Glacier2.Client.Endpoints"
              value="\${client-endpoints}"/>
    <property name="Glacier2.Server.Endpoints"
              value="\${server-endpoints}"/>
    <property name="Glacier2.Admin.Endpoints"
              value="tcp -h 127.0.0.1"/>
    <property name="Glacier2.Admin.RegisterProcess"
              value="1"/>
  </properties>
  </server>
</server-template>
```

```

    <property name="Glacier2.InstanceName"
             value="{instance-name}"/>
    <property name="Glacier2.SessionTimeout"
             value="{session-timeout}"/>
  </properties>
</server-template>

```

Notice that the server's pathname is `glacier2router`, meaning the program must be present in the node's executable search path. Another important point is the server's activation mode: it uses manual activation (the default), meaning the router must be started manually. This requirement becomes clear when you consider that the router is the point of contact for remote clients; if the router is not running, there is no way for a client to contact the locator and cause the router to be started on-demand.

The template defines only a few properties; if you want to set additional properties, you can define them in the server instance property set.

Of interest is the `instance-name` parameter, which allows you to configure the `Glacier2.InstanceName` property. The parameter's default value includes the name of the application in which the template is used. This parameter also affects the identities of the objects implemented by the router (see Section 41.3.5).

Consider the following sample application:

```

<icegrid>
  <application name="Glacier2Demo">
    <node name="Node">
      <server-instance template="Glacier2"
                      client-endpoints="tcp -h 5.6.7.8 -p 8000"
                      session-timeout="300"
                      server-endpoints="tcp -h 10.0.0.1"/>
      ...
    </node>
  </application>
</icegrid>

```

Instantiating the `Glacier2` template creates a server identified as `Glacier2Demo.Glacier2` (as determined by the default value for the `instance-name` parameter). The router's objects use this value as the category in their identities, such as `Glacier2Demo.Glacier2/router`. The router proxy used by clients must contain a matching identity.

In order to refer to the `Glacier2` template in your application, you must have already configured the registry to use the `config/templates.xml` file

as your default templates (see Section 37.6.4), or copied the template into the XML file describing your application.

Note that IceGrid cannot start a Glacier2 router if the router's security configuration requires that a passphrase be entered. In this situation, you have no choice but to start the router yourself so that you can provide the passphrase when prompted.

37.14 XML Reference

This section provides a reference for the XML elements that define IceGrid descriptors, in alphabetical order.

37.14.1 Adapter

An `adapter` element defines an indirect object adapter. Refer to Section 31.4 for more information on object adapters.

Context

This element may only appear as a child of a `server` or `service` element.

Attributes

This element supports the attributes in Table 37.2.

Table 37.2. Attributes of the `adapter` element.

Attribute	Description	Required
<code>endpoints</code>	Specifies one or more endpoints for this object adapter. These endpoints typically do not specify a port. This attribute is translated into a definition of the adapter's <code>Endpoints</code> configuration property (see Appendix C).	No

Table 37.2. Attributes of the `adapter` element.

Attribute	Description	Required
id	Specifies an object adapter identifier. The identifier must be unique among all adapters and replica groups in the registry. This attribute is translated into a definition of the adapter's <code>AdapterId</code> configuration property (see Appendix C). If not defined, a default value is constructed from the adapter name and server id (and service name for an IceBox service).	Yes
name	The name of the object adapter as used in the server that creates it.	Yes
register-process	If the value is <code>true</code> , this object adapter registers an object in the IceGrid registry that facilitates graceful shutdown of the server. Only one object adapter in a server should set this attribute to <code>true</code> . If not defined, the default value is <code>false</code> .	No
replica-group	Specifies a replica group identifier. A non-empty value signals that this object adapter is a member of the indicated replica group. This attribute is translated into a definition of the adapter's <code>RepliaGroupId</code> configuration property (see Appendix C). See Section 37.8 for more information on replication. If not defined, the default value is an empty string.	No
wait-for-activation	If the value is <code>true</code> , server activation is considered complete only when this object adapter has been activated and has registered itself in the IceGrid registry. If not defined, the default value is <code>true</code> .	No

An optional nested `description` element provides free-form descriptive text.

Example

```

<adapter name="MyAdapter"
  endpoints="default"
  id="MyAdapterId"
  register-process="true"
  replica-group="MyReplicaGroup"
  wait-for-activation="true">
  <description>A description of the adapter.</description>
  ...
</adapter>

```

37.14.2 Allocatable

An allocatable element defines an allocatable object in the IceGrid registry. Clients can allocate this object using only its identity, or they can allocate objects of a specific type. Refer to Section 37.10.3 for more information on allocatable objects.

Context

This element may only appear as a child of an adapter element (Section 37.14.1).

Attributes

This element supports the attributes in Table 37.3.

Table 37.3. Attributes of the allocatable element.

Attribute	Description	Required
identity	Specifies the identity by which this allocatable object is known.	Yes
type	An arbitrary string used to group allocatable objects. By convention, the string represents the most-derived Slice type of the object, but an application is free to use another convention.	No

37.14.3 Application

An `application` element defines an IceGrid application. Refer to Section 37.3 for more information. An application typically contains at least one `node` element, but it may also be used for other purposes such as defining server and service templates, default templates, replica groups and property sets.

Context

This element must be a child of an `icegrid` element. Only one `application` element is permitted per file.

Attributes

This element supports the attributes in Table 37.4.

Table 37.4. Attributes of the `application` element.

Attribute	Description	Required
<code>import-default-templates</code>	If <code>true</code> , the default templates configured for the IceGrid registry are imported and available for use within this application. See Section 37.6.4 for more information on default templates. If not specified, the default value is <code>false</code> .	No
<code>name</code>	The name of the application. This name must be unique among all applications in the registry. Within the application, child elements can refer to its name using the reserved variable <code>\${application}</code> .	Yes

An optional nested `description` element provides free-form descriptive text.

Example

```
<icegrid>
  <application name="MyApplication"
    import-default-templates="true">
    <description>A description of the
```

```

        application.</description>
        ...
    </application>
</icegrid>

```

37.14.4 DbEnv

A `dbenv` element causes an IceGrid node to generate Freeze configuration properties for the server or service in which it is defined, and may cause the node to create a database environment directory if necessary. This element may contain `dbproperty` elements (Section 37.14.5). See Chapter 38 for more information on Freeze.

Context

This element may only appear as a child of a `server` element (Section 37.14.18) or a `service` element (Section 37.14.21).

Attributes

This element supports the attributes in Table 37.5.

Table 37.5. Attributes of the `dbenv` element.

Attribute	Description	Required
<code>home</code>	Specifies the directory to use as the database environment. If not defined, a subdirectory within the node's data directory is used.	No
<code>name</code>	The name of the database environment.	Yes

The values of the `name` and `home` attributes are used to define the configuration property shown below:

```
Freeze.DbEnv.name.DbHome=home
```

An optional nested `description` element provides free-form descriptive text.

Example

```
<dbenv name="MyEnv" home="/opt/data/db">
  <description>A description of the
    database environment.</description>
  . . .
</dbenv>
```

37.14.5 DbProperty

A `dbproperty` element defines a BerkeleyDB configuration property. See Chapter 38 for more information on Freeze.

Context

This element may only appear as a child of a `dbenv` element (Section 37.14.4).

Attributes

This element supports the attributes in Table 37.6.

Table 37.6. Attributes of the `dbproperty` element.

Attribute	Description	Required
name	The name of the configuration property.	Yes
value	The value of the configuration property. If not defined, the value is an empty string.	No

Example

```
<dbenv name="MyEnv" home="/opt/data/db">
  <description>A description of the
    database environment.</description>
  <dbproperty name="set_cachesize" value="0 52428800 1"/>
</dbenv>
```

37.14.6 Description

A `description` element specifies a description of its parent element.

Context

This element may only appear as a child of the `application`, `replica-group`, `node`, `server`, `service`, `icebox`, `adapter`, and `dbenv` elements.

Attributes

This element supports no attributes.

Example

```
<node name="localnode">
  <description>Free form descriptive text for
    localnode</description>
</node>
```

37.14.7 Directory

A `directory` element specifies a directory in a distribution. Refer to Section 37.11 for more information on distribution descriptors.

Context

This element may only appear as a child of the `distrib` element (Section 37.14.8).

Attributes

This element supports no attributes.

37.14.8 Distrib

A `distrib` element specifies the files to download from an IcePatch2 server as well as the server's proxy. Refer to Section 37.11 for more information on distribution descriptors.

Context

This element may only appear as a child of a `application` element (Section 37.14.3) or a `server` element (Section 37.14.18).

Attributes

This element supports the attributes in Table 37.7.

Table 37.7. Attributes of the `distrib` element.

Attribute	Description	Required
<code>icepatch</code>	Specifies the proxy of the IcePatch2 server. If not defined, the default value is <code>\${application}.IcePatch2/server</code> .	No

Example

```
<distrib icepatch="DemoIcePatch2/server:tcp -p 12345">
  <directory>dir1</directory>
  <directory>dir2/subdir</directory>
</distrib>
```

37.14.9 IceBox

An `icebox` element defines an IceBox server to be deployed on a node. It typically contains at least one `service` element (Section 37.14.21), and may supply additional information such as command-line options (Section 37.14.25), environment variables (Section 37.14.26), configuration properties (Section 37.14.16) and a server distribution (Section 37.11).

The element may optionally contain a single `adapter` element (Section 37.14.1) that configures the IceBox service manager's object adapter and must have the name `IceBox.ServiceManager`. If no such element is defined, the adapter's default configuration is shown below:

```
<adapter name="IceBox.ServiceManager"
  register-process="true"
  id=""
  endpoints="tcp -h 127.0.0.1"/>
```

See Chapter 42 for more information on IceBox.

Context

This element may only appear as a child of a `node` element (Section 37.14.12) or a `server-template` element (Section 37.14.20).

Attributes

This element supports the attributes in Table 37.8.

Table 37.8. Attributes of the `icebox` element.

Attribute	Description	Required
<code>activation-mode</code>	Specifies whether the server uses manual or on-demand activation. If not defined, manual activation is used by default.	No
<code>activation-timeout</code>	Defines the number of seconds a node will wait for the server to activate. If the timeout expires, a client waiting to receive the endpoints of an object adapter in this server will receive an empty set of endpoints. If not defined, the default timeout is the value of the <code>IceGrid.Node.WaitTime</code> property configured for the server's node.	No
<code>application-distrib</code>	Specifies whether this server's distribution is dependent on the application's distribution. If the value is <code>true</code> , the server cannot be patched until the application has been patched. If not defined, the default value is <code>true</code> . See Section 37.11.3 for more information on distribution dependencies.	No
<code>deactivation-timeout</code>	Defines the number of seconds a node will wait for the server to deactivate. If the timeout expires, the node terminates the server process. If not defined, the default timeout is the value of the node's configuration property <code>IceGrid.Node.WaitTime</code> .	No
<code>exe</code>	The pathname of the server executable.	Yes

Table 37.8. Attributes of the `icebox` element.

Attribute	Description	Required
<code>id</code>	Specifies the identifier for this IceBox server. The identifier must be unique among all servers in the registry. Within the server, child elements can refer to its identifier using the reserved variable <code>\${server}</code> .	Yes
<code>pwd</code>	The default working directory for the server. If not defined, the server is started in the node's current working directory.	No

The IceGrid node on which this server is deployed generates the following configuration property for the server:

```
IceBox.InstanceName=${server}
```

An optional nested `description` element provides free-form descriptive text.

Example

```
<icebox id="MyIceBox"
  activation="on-demand"
  activation-timeout="60"
  application-distrib="false"
  deactivation-timeout="60"
  exe="/opt/Ice/bin/icebox"
  pwd="/">
  <option>--Ice.Trace.Network=1</option>
  <env>PATH=/opt/Ice/bin:$PATH</env>
  <property name="ServerId" value="${server}"/>
  <service id="Service1" .../>
  <service-instance id="Service2"
    template="ServiceTemplate .../>
</icebox>
```

37.14.10 IceGrid

The `icegrid` element is the top-level element for IceGrid descriptors in XML files. This elements supports no attributes.

37.14.11 Load Balancing

A load-balancing element determines the load balancing policy used by a replica group. Refer to Section 37.9 for details on load balancing.

Context

This element may only appear as a child of a `replica-group` element (Section 37.14.17).

Attributes

This element supports the attributes in Table 37.9.

Table 37.9. Attributes of the load-balancing element.

Attribute	Description	Required
load-sample	Specifies the load sample to use for the adaptive load balancing policy. It can only be defined if <code>type</code> is set to <code>adaptive</code> . Legal values are 1, 5 and 15. If not specified, the load sample default value is 1.	No
n-replicas	Specifies the maximum number of replicas used to compute the endpoints of the replica group.	No
type	Specifies the type of load balancing. Legal values are <code>adaptive</code> , <code>round-robin</code> and <code>random</code> .	Yes

Example

```
<application name="MyApp">
  <replica-group id="ReplicatedAdapter">
    <load-balancing type="adaptive" load-sample="15"
      n-replicas="3"/>
    <description>A description of this
      replica group.</description>
```

```

        <object identity="WellKnownObject" .../>
    </replica-group>
    ...
</application>

```

37.14.12 Node

A `node` element defines an IceGrid node. The servers that the node is responsible for managing are described in child elements.

Context

This element may only appear as a child of an `application` element (Section 37.14.3). Multiple `node` elements having the same name may appear in an application. Their contents are merged and the last definition of `load-factor` has precedence.

Attributes

This element supports the attributes in Table 37.10.

Table 37.10. Attributes of the `node` element.

Attribute	Description	Required
<code>load-factor</code>	A floating point value defining the factor that is multiplied with the node's load average. The load average is used by the adaptive load balancing policy to figure out which node is the least loaded (see Section 37.9.2). The default is 1.0 on Unix platforms and 1/NCPUS on Windows (where NCPUS is the number of CPUs in the node's computer). Note that, if Unix and Windows machines are part of a replica group, the Unix and Windows figures are not directly comparable, but still make an attempt to pick the least-loaded node.	No

Table 37.10. Attributes of the node element.

Attribute	Description	Required
name	Specifies the name of this node. The name must be unique among all nodes in the registry. Within the node, child elements can refer to its name using the reserved variable <code>\${node}</code> . An <code>icegridnode</code> process representing this node must be started on the desired computer and its configuration property <code>IceGrid.Node.Name</code> must match this attribute (see Section 37.18.2).	Yes

Example

```

<node name="Node1" load-factor="2.0">
  <description>A description of this node.</description>
  <server id="Server1" ...>
    <property name="NodeName" value="${node}"/>
    ...
  </server>
</node>

```

37.14.13 Object

An `object` element defines a well-known object in the IceGrid registry. Clients can refer to this object using only its identity, or they can search for well-known objects of a specific type. Refer to Section 37.5 for more information on well-known objects.

Context

This element may only appear as a child of an `adapter` element (Section 37.14.1) or a `replica-group` element (Section 37.14.17).

Attributes

This element supports the attributes in Table 37.11.

Table 37.11. Attributes of the `object` element.

Attribute	Description	Required
<code>identity</code>	Specifies the identity by which this object is known.	Yes
<code>type</code>	An arbitrary string used to group objects. By convention, the string represents the most-derived Slice type of the object, but an application is free to use another convention.	No

Example

```
<adapter name="MyAdapter" id="WellKnownAdapter" ...>
  <object identity="WellKnownObject"
    type="::Module::WellKnownInterface"/>
</adapter>
```

In the configuration above, the object can be located via the equivalent proxies `WellKnownObject` and `WellKnownObject@WellKnownAdapter`.

37.14.14 Parameter

A `parameter` element defines a template parameter. Template parameters must be declared with this element to be used in template instantiation.

Context

This element may only appear as a child of a `server-template` element (Section 37.14.20) or a `service-template` element (Section 37.14.23).

Attributes

This element supports the attributes in Table 37.12.

Table 37.12. Attributes of the `parameter` element.

Attribute	Description	Required
<code>name</code>	The name of the parameter. For example, if <code>index</code> is used as the name of a parameter, it can be referenced using <code>#{index}</code> in the server or service template.	Yes
<code>default</code>	An optional default value for the parameter. This value is used if the parameter is not defined when a server or service is instantiated.	No

Example

```
<server-template id="MyServerTemplate">
  <parameter name="index"/>
  <parameter name="exepath" default="/opt/myapp/bin/server"/>
  ...
</server-template>
```

37.14.15 Properties

The `properties` element is used in three situations:

- as a named property set if the `id` attribute is specified
- as a reference to a named property set if the `refid` attribute is specified
- as an unnamed property set if no attributes are specified.

A property set is useful to define a set of properties (a named property set) in application or node descriptors. Named property sets can be included in named or unnamed property sets with property set references.

Context

A named property set element may only be a child of an `application` element (Section 37.14.3) or a `node` (Section 37.14.12) element. An unnamed property set element may only be a child of a `server`, `icebox`, `service`, `server-`

instance or service-instance element. A reference to a named property set can only be a child of a named or unnamed property set element.

Attributes

This element supports the attributes in Table 37.13.

Table 37.13. Attributes of the `properties` element.

Attribute	Description	Required
id	Defines a new named property set with the given identifier. The identifier must be unique among all named property sets defined in the same scope. If not specified, the <code>properties</code> element refers to an unnamed property set or a property set reference.	No
refid	Defines a reference to the named property set with the given identifier. If not specified, the element refers to an unnamed or named property set.	No

Example

```
<application name="Simple">
  <properties id="Debug">
    <property name="Ice.Trace.Network" value="1"/>
  </properties>

  <server id="MyServer" exe="./server">
    <properties>
      <properties refid="Debug"/>
      <property name="AppProperty" value="1"/>
    </properties>
  </server>
</application>
```

37.14.16 Property

An IceGrid node generates a configuration file for each of its servers and services. This file generally should not be edited manually because any changes will be lost

the next time the node generates the file. The `property` element is the correct way to define additional properties in a configuration file.

Context

This element may only appear as a child of a `server` element (Section 37.14.18), a `service` element (Section 37.14.21), an `icebox` element (Section 37.14.9) or a `properties` element (Section 37.14.15).

Attributes

This element supports the attributes in Table 37.14.

Table 37.14. Attributes of the `property` element.

Attribute	Description	Required
<code>name</code>	Specifies the property name.	Yes
<code>value</code>	Specifies the property value. If not defined, the value is an empty string.	No

Example

```
<server id="MyServer" ...>
  <property name="Ice.ThreadPool.Server.SizeMax" value="10"/>
  ...
</server>
```

This property element adds the following definition to the server's configuration file:

```
Ice.ThreadPool.Server.SizeMax=10
```

37.14.17 Replica Group

A `replica-group` element creates a virtual object adapter in order to provide replication and load balancing for a collection of object adapters. An `adapter` element (Section 37.14.1) declares its membership in a group by identifying the desired replica group. The element may declare well-known objects (Section 37.5) that are available in all of the participating object adapters. A `replica-group` element may contain a load-balancing child element

that specifies the load-balancing algorithm the registry should use when resolving locate requests.

Refer to Section 37.8 for more information on replication and Section 37.9 for details on load balancing.

Context

This element may only appear as a child of an `application` element (Section 37.14.3).

Attributes

This element supports the attributes in Table 37.15.

Table 37.15. Attributes of the `replica-group` element.

Attribute	Description	Required
<code>id</code>	Specifies the identifier of the replica group, which must be unique among all adapters and replica groups in the registry. This identifier can be used in indirect proxies in place of an adapter identifier.	Yes

An optional nested `description` element provides free-form descriptive text.

Example

```
<application name="MyApp">
  <replica-group id="ReplicatedAdapter">
    <load-balancing type="adaptive" load-sample="15"
      n-replicas="3"/>
    <description>A description of this
      replica group.</description>
    <object identity="WellKnownObject" .../>
  </replica-group>
  ...
</application>
```

In this example, the proxy `WellKnownObject` is equivalent to the proxy `WellKnownObject@ReplicatedAdapter`.

37.14.18 Server

A `server` element defines a server to be deployed on a node. It typically contains at least one `adapter` element (Section 37.14.1), and may supply additional information such as command-line options (Section 37.14.25), environment variables (Section 37.14.26), configuration properties (Section 37.14.16), and a server distribution (Section 37.11).

Context

This element may only appear as a child of a `node` element (Section 37.14.12) or a `server-template` element (Section 37.14.20).

Attributes

This element supports the attributes in Table 37.16.

Table 37.16. Attributes of the `server` element.

Attribute	Description	Required
<code>activation</code>	Specifies whether the server's activation mode. Legal values are <code>manual</code> , <code>on-demand</code> , <code>always</code> and <code>session</code> . If not specified, <code>manual</code> activation is used by default. See Section 37.20 for more information.	No
<code>activation-timeout</code>	Defines the number of seconds a node will wait for the server to activate. If the timeout expires, a client waiting to receive the endpoints of an object adapter in this server will receive an empty set of endpoints. If not defined, the default timeout is the value of the <code>IceGrid.Node.WaitTime</code> property configured for the server's node.	No

Table 37.16. Attributes of the `server` element.

Attribute	Description	Required
allocatable	Specifies whether the server can be allocated. A server is allocated implicitly when one of its allocatable objects is allocated. The value of this attribute is ignored if the server activation mode is <code>session</code> ; a server with this activation mode is always allocatable. Otherwise, if not specified and the server activation mode is not <code>session</code> , the server is not allocatable.	No
application-distrib	Specifies whether this server's distribution is dependent on the application's distribution. If the value is <code>true</code> , the server cannot be patched until the application has been patched. If not defined, the default value is <code>true</code> . See Section 37.11.3 for more information on distribution dependencies.	No
deactivation-timeout	Defines the number of seconds a node will wait for the server to deactivate. If the timeout expires, the node terminates the server process. If not defined, the default timeout is the value of the node's configuration property <code>IceGrid.Node.WaitTime</code> .	No
exe	The pathname of the server executable.	Yes
id	Specifies the identifier for this server. The identifier must be unique among all servers in the registry. Within the server, child elements can refer to its identifier using the reserved variable <code>\${server}</code> .	Yes
pwd	The default working directory for the server. If not defined, the server is started in the node's current working directory.	No

Table 37.16. Attributes of the `server` element.

Attribute	Description	Required
user	<p>Specifies the name of the user account under which the server is activated and run. If a user account mapper is configured for the node, the value of this attribute is used to find the corresponding account in the map.</p> <p>On Unix, the node must be running as root to be able to run servers under a different user account. On Windows, or if the node is not running as root on Unix, the only permissible value for this attribute is an empty string or the name of the user account under which the node is running.</p> <p>On Unix, if the node is running as root and this attribute is not specified, the server is run under the user <code>\${session.id}</code> if the server activation mode is <code>session</code> or under the user <code>nobody</code> if the activation mode is <code>manual</code>, <code>on-demand</code> or <code>always</code>.</p>	No

An optional nested `description` element provides free-form descriptive text.

Example

```

<server id="MyServer"
  activation="on-demand"
  activation-timeout="60"
  application-distrib="false"
  deactivation-timeout="60"
  exe="/opt/app/bin/myserver"
  pwd="/">
  <option>--Ice.Trace.Network=1</option>
  <env>PATH=/opt/Ice/bin:$PATH</env>
  <property name="ServerId" value="${server}"/>
  <adapter name="Adapter1" .../>
</server>

```

37.14.19 Server Instance

A `server-instance` element deploys an instance of a `server-template` element (Section 37.14.20) on a node. Refer to Section 37.6 for more information on templates.

Context

This element may only appear as a child of a `node` element (Section 37.14.12).

Attributes

This element supports the attributes in Table 37.17.

Table 37.17. Attributes of the `server-instance` element.

Attribute	Description	Required
template	Identifies the server template.	Yes

All other attributes of the element must correspond to parameters declared by the template. The `server-instance` element must provide a value for each parameter that does not have a default value supplied by the template.

Example

```
<icegrid>
  <application name="SampleApp">
    <server-template id="ServerTemplate">
      <parameter name="id"/>
      <server id="{id}" activation="manual" .../>
    </server-template>
    <node name="Node1">
      <server-instance template="ServerTemplate"
        id="TheServer"/>
    </node>
  </application>
</icegrid>
```

37.14.20 Server Template

A `server-template` element defines a template for a `server` element (Section 37.14.18), simplifying the task of deploying multiple instances of the same server definition. The template should contain a parameterized `server` element that is instantiated using a `server-instance` element (Section 37.14.19). Refer to Section 37.6 for more information on templates.

Context

This element may only appear as a child of an `application` element (Section 37.14.3).

Attributes

This element supports the attributes in Table 37.18.

Table 37.18. Attributes of the `server-template` element.

Attribute	Description	Required
id	Specifies the identifier for the server template. This identifier must be unique among all server templates in the application.	Yes

Parameters

A template may declare parameters that are used to instantiate the `server` element. You can define a default value for each parameter. Parameters without a default value are considered mandatory and values for them must be supplied by the `server-instance` element. See Section 37.15 for more information on parameter semantics.

Example

```
<icegrid>
  <application name="SampleApp">
    <server-template id="ServerTemplate">
      <parameter name="id"/>
      <server id="${id}" activation="manual" .../>
    </server-template>
    <node name="Node1">
```

```

        <server-instance template="ServerTemplate"
            id="TheServer"/>
    </node>
</application>
</icegrid>

```

37.14.21 Service

A *service* element defines an IceBox service. It typically contains at least one *adapter* element (Section 37.14.1), and may supply additional information such as configuration properties (Section 37.14.16).

Refer to Section 37.7 for more information on using IceBox services in IceGrid.

Context

This element may only appear as a child of an *icebox* element (Section 37.14.9) or a *service-template* element (Section 37.14.23).

Attributes

This element supports the attributes in Table 37.19.

Table 37.19. Attributes of the *service* element.

Attribute	Description	Required
entry	Specifies the entry point of this service.	Yes
name	Specifies the name of this service. Within the service, child elements can refer to its name using the reserved variable <code>\${service}</code> .	Yes

An optional nested *description* element provides free-form descriptive text.

Example

```

<icebox id="MyIceBox" ...>
  <service name="Service1" entry="service1:Create">
    <description>A description of this service.</description>
    <property name="ServiceName" value="${service}"/>
  </service>
</icebox>

```

```

        <adapter name="MyAdapter" id="{service}Adapter" .../>
    </service>
    <service name="Service2" entry="service2:Create"/>
</icebox>

```

37.14.22 Service Instance

A `service-instance` element creates an instance of a `service-template` element in an IceBox server (see Section 37.7). Refer to Section 37.6 for more information on templates.

Context

This element may only appear as a child of an `icebox` element (Section 37.14.9).

Attributes

This element supports the attributes in Table 37.20.

Table 37.20. Attributes of the `service-instance` element.

Attribute	Description	Required
template	Identifies the service template.	Yes

All other attributes of the element must correspond to parameters declared by the template. The `service-instance` element must provide a value for each parameter that does not have a default value supplied by the template.

Example

```

<icebox id="IceBoxServer" ...>
    <service-instance template="ServiceTemplate" name="Service1"/>
</icebox>

```

37.14.23 Service Template

A `service-template` element defines a template for a `service` element (Section 37.14.21), simplifying the task of deploying multiple instances of the

same service definition. The template should contain a parameterized `service` element that is instantiated using a `service-instance` element (Section 37.14.22). Refer to Section 37.7.2 for more information on service templates.

Context

This element may only appear as a child of an `application` element (Section 37.14.3).

Attributes

This element supports the attributes in Table 37.21.

Table 37.21. Attributes of the `service-template` element.

Attribute	Description	Required
id	Specifies the identifier for the service template. This identifier must be unique among all service templates in the application.	Yes

Parameters

A template may declare parameters that are used to instantiate the `service` element. You can define a default value for each parameter. Parameters without a default value are considered mandatory and values for them must be supplied by the `service-instance` element. See Section 37.15 for more information on parameter semantics.

Example

```
<icegrid>
  <application name="IceBoxApp">
    <service-template id="ServiceTemplate">
      <parameter name="name"/>
      <service name="{name}" entry="DemoService:create">
        <adapter name="{service}" .../>
      </service>
    </service-template>
    <node name="Node1">
      <icebox id="IceBoxServer" ...>
```

```

        <service-instance template="ServiceTemplate"
            name="Service1"/>
    </icebox>
</node>
</application>
</icegrid>

```

37.14.24 Variable

A `variable` element defines a variable. See Section 37.15 for more information on variable semantics.

Context

This element may only appear as a child of an `application` element (Section 37.14.3) or `node` element (Section 37.14.12).

Attributes

This element supports the attributes in Table 37.22.

Table 37.22. Attributes of the `variable` element.

Attribute	Description	Required
<code>name</code>	Specifies the variable name. The value of this variable is substituted whenever its name is used in variable syntax, as in <code>\${name}</code> .	Yes
<code>value</code>	Specifies the variable value. If not defined, the default value is an empty string.	No

Example

```

<icegrid>
  <application name="SampleApp">
    <variable name="Var1" value="foo"/>
    <variable name="Var2" value="${Var1}bar"/>
    ...
  </application>
</icegrid>

```

37.14.25 Command Line Options

Server descriptors (Section 37.14.18) and icebox descriptors (Section 37.14.9) may specify command-line options that the node will pass to the program at startup. As the node prepares to execute the server, it assembles the command by appending options to the server executable's pathname.

In XML, you define a command-line option using the `option` element:

```
<server id="Server1" ...>
  <option>--Ice.Trace.Protocol</option>
  ...
</server>
```

The node preserves the order of options, which is especially important for Java servers. For example, JVM options must appear before the class name, as shown below:

```
<server id="JavaServer" exe="java" ...>
  <option>-Xnoclassgc</option>
  <option>ServerClassName</option>
  <option>--Ice.Trace.Protocol</option>
  ...
</server>
```

The node translates these options into the following command:

```
java -Xnoclassgc ServerClassName --Ice.Trace.Protocol
```

37.14.26 Environment Variables

Server descriptors (Section 37.14.18) and icebox descriptors (Section 37.14.9) may specify environment variables that the node will define when starting a server. An environment variable definition uses the familiar `name=value` syntax, and you can also refer to other environment variables within the value. The exact syntax for variable references depends on the platform on which the server's descriptor is deployed.

On a Unix platform, the Bourne shell syntax is required:

```
LD_LIBRARY_PATH=/opt/Ice/lib:$LD_LIBRARY_PATH
```

On a Windows platform, the syntax uses the conventional style:

```
PATH=/opt/Ice/lib;%PATH%
```

In XML, the `env` element supplies a definition for an environment variable:

```

<node name="UnixBox">
  <server id="UnixServer" exe="/opt/app/bin/server" ...>
    <env>LD_LIBRARY_PATH=/opt/Ice/lib:$LD_LIBRARY_PATH</env>
    ...
  </server>
</node>
<node name="WindowsBox">
  <server id="WindowsServer" exe="C:/app/bin/server.exe" ...>
    <env>PATH=C:/Ice/lib;%PATH%</env>
    ...
  </server>
</node>

```

If a value refers to an environment variable that is not defined, the reference is substituted with an empty string.

Environment variable definitions may also refer to descriptor variables and template parameters:

```

<node name="UnixBox">
  <server id="UnixServer" exe="/opt/app/bin/server" ...>
    <env>PATH=${server.distrib}/bin:$PATH</env>
    ...
  </server>
</node>

```

On Unix, an environment variable VAR can be referenced as \$VAR or \${VAR}.

You must be careful when using the latter syntax because IceGrid assumes \${VAR} refers to a descriptor variable or parameter and will report an error if no match is found. If you prefer to use this style to refer to environment variables, you must escape these occurrences as shown in the example below:

```

<node name="UnixBox">
  <server id="UnixServer" exe="/opt/app/bin/server" ...>
    <env>PATH=${server.distrib}/bin:${PATH}</env>
    ...
  </server>
</node>

```

IceGrid does not attempt to perform substitution on \$\$ {PATH}, but rather removes the leading \$ character and then performs environment variable substitution on \$ {PATH}. See Section 37.15.1 for more information on escaping variables.

37.15 Variable and Parameter Semantics

Variable descriptors (see Section 37.14.24) allow you to define commonly-used information once and refer to them symbolically throughout your application descriptors.

37.15.1 Syntax

Substitution for a variable or parameter VP is attempted whenever the symbol $\${VP}$ is encountered, subject to the limitations and rules described below. Substitution is case-sensitive, and a fatal error occurs if VP is not defined.

Limitations

Substitution is only performed in string values, and excludes the following cases:

- in the identifier of a template descriptor definition:
`<server-template id="\${invalid}" ...>`
- in the name of a variable definition
`<variable name="\${invalid}" ...>`
- in the name of a template parameter definition
`<parameter name="\${invalid}" ...>`
- in the name of a template parameter assignment
`<server-instance template="T" \${invalid}="val" ...>`
- in the name of a node definition
`<node name="\${invalid}" ...>`
- in the name of an application definition
`<application name="\${invalid}" ...>`

Substitution is not supported for values of other types. The example below demonstrates an invalid use of substitution:

```
<variable name="register" value="true"/>
<node name="Node">
  <server id="Server1" ...>
    <adapter name="Adapter1" register-process=\${register} .../>
```

In this case, a variable cannot supply the value of `register-process` because that attribute expects a boolean value, not a string.

Most values are strings, however, so this limitation is rarely a problem.

Escaping a Variable

You can prevent substitution by escaping a variable reference with an additional leading `$` character. For example, in order to assign the literal string `${abc}` to a variable, you must escape it as shown below:

```
<variable name="x" value="$$${abc}"/>
```

The extra `$` symbol is only meaningful when immediately preceding a variable reference, therefore text such as `US$$55` is not modified. Each occurrence of the characters `$$` preceding a variable reference is replaced with a single `$` character, and that character does not initiate a variable reference. Consider these examples:

```
<variable name="a" value="hi"/>
<variable name="b" value="$$${a}"/>
<variable name="c" value="$$$${a}"/>
<variable name="d" value="$$$$${a}"/>
```

After substitution, `b` has the value `${a}`, `c` has the value `$hi`, and `d` has the value `$$${a}`.

37.15.2 Reserved Names

IceGrid defines a set of read-only variables to hold information that may be of use to descriptors. The names of these variables are reserved and cannot be used as variable or parameter names. Table 37.23 describes the purpose of each variable and defines the context in which it is valid.

Table 37.23. Reserved names.

Name	Description
<code>application</code>	The name of the enclosing application.
<code>application.distrib</code>	The pathname of the enclosing application's distribution directory, and an alias for <code> \${node.data-dir}/distrib/\${application}</code> .

Table 37.23. Reserved names.

Name	Description
<code>node</code>	The name of the enclosing node.
<code>node.os</code>	The name of the enclosing node's operating system. On Unix, this value is provided by <code>uname</code> . On Windows, the value is <code>Windows</code> .
<code>node.hostname</code>	The host name of the enclosing node.
<code>node.release</code>	The operation system release of the enclosing node. On Unix, this value is provided by <code>uname</code> . On Windows, the value is obtained from the <code>OSVERSIONINFO</code> data structure.
<code>node.version</code>	The operation system version of the enclosing node. On Unix, this value is provided by <code>uname</code> . On Windows, the value represents the current service pack level.
<code>node.machine</code>	The machine hardware name of the enclosing node. On Unix, this value is provided by <code>uname</code> . On Windows, the value is <code>x86</code> .
<code>node.datadir</code>	The absolute pathname of the enclosing node's data directory.
<code>server</code>	The id of the enclosing server.
<code>server.distrib</code>	The pathname of the enclosing server's distribution directory, and an alias for <code>\${node.datadir}/servers/\${server}/distrib</code> .
<code>service</code>	The name of the enclosing service.
<code>session.id</code>	The client session identifier. For sessions created with a user name and password, the value is the user ID; for sessions created from a secure connection, the value is the distinguished name associated with the connection.

The availability of a variable is easily determined in some cases, but may not be readily apparent in others. For example, the following example represents a valid use of the `#{node}` variable:

```
<icegrid>
  <application name="App">
    <server-template id="T" ...>
      <parameter name="id"/>
      <server id="#{id}" ...>
        <property name="NodeName" value="#{node}"/>
        ...
      </server>
    </server-template>
    <node name="TheNode">
      <server-instance template="T" id="TheServer"/>
    </node>
  </application>
</icegrid>
```

Although the server template descriptor is defined as a child of an application descriptor, its variables are not evaluated until it is instantiated. Since a template *instance* is always enclosed within a node, it is able to use the `#{node}` variable.

37.15.3 Scoping Rules

Descriptors may only define variables at the application and node levels. Each node introduces a new scope, such that defining a variable at the node level overrides (but does not modify) the value of an application variable with the same name. Similarly, a template parameter overrides the value of a variable with the same name in an enclosing scope. A descriptor may refer to a variable defined in

any enclosing scope, but its value is determined by the nearest scope. Figure 37.7 illustrates these concepts.

Figure 37.7. Variable scoping semantics.

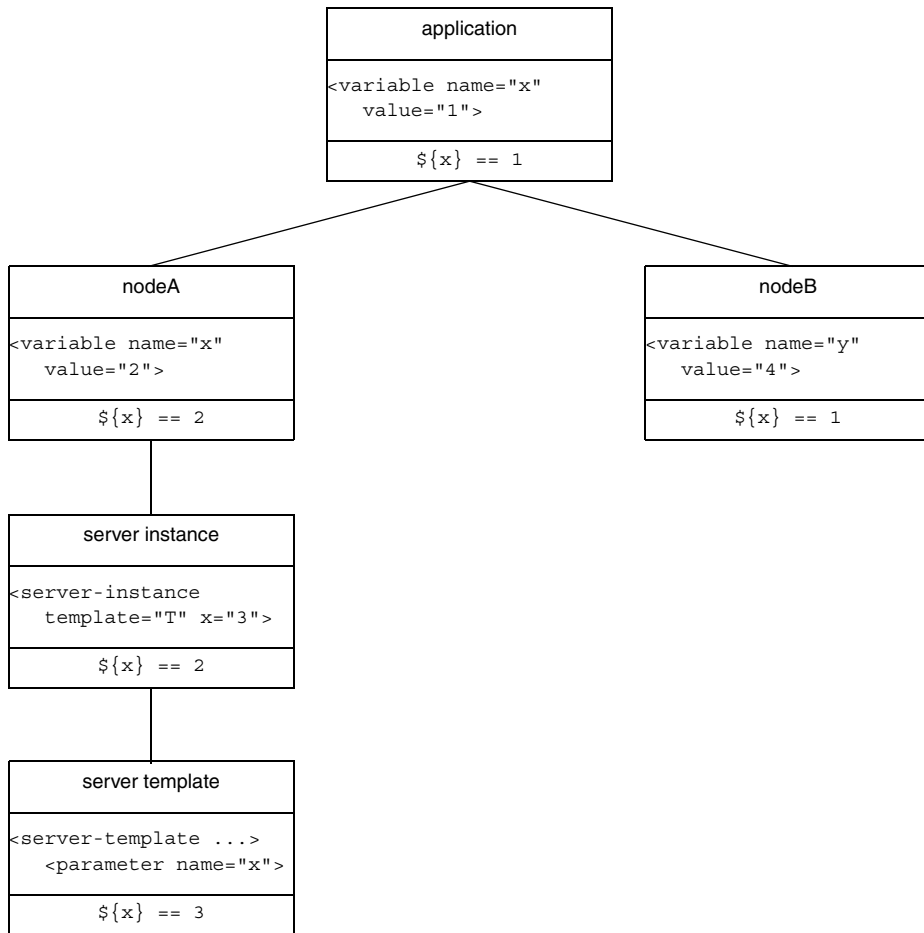

In this diagram, the variable `x` is defined at the application level with the value 1. In `nodeA`, `x` is overridden with the value 2, whereas `x` remains unchanged in `nodeB`. Within the context of `nodeA`, `x` continues to have the value 2 in a server instance definition. However, when `x` is used as the name of a template parameter,

the node's definition of `x` is overridden and `x` has the value 3 in the template's scope.

Resolving a Reference

To resolve a variable reference `${var}`, IceGrid searches for a definition of `var` using the following order of precedence:

1. Pre-defined variables (see Section 37.15.2)
2. Template parameters, if applicable
3. Node variables, if applicable
4. Application variables

After the initial substitution, any remaining references are resolved recursively using the following order of precedence:

1. Pre-defined variables (see Section 37.15.2)
2. Node variables, if applicable
3. Application variables

Template Parameters

Template parameters are not visible in nested template instances. This situation can only occur when an IceBox server template instantiates a service template, as shown in the following example:

```
<icegrid>
  <application name="IceBoxApp">
    <service-template id="ServiceTemplate">
      <parameter name="name"/>
      <service name="${name}" entry="DemoService:create">
        ...
        <property name="${name}.Identity"
          value="${id}-${name}"/> <!-- WRONG! -->
      </service>
    </service-template>
  <server-template id="ServerTemplate">
    <parameter name="id"/>
    <icebox id="${id}" endpoints="default" ...>
      <service-instance template="ServiceTemplate"
        name="Service1"/>
    </icebox>
  </server-template>
</node name="Node1">
  <server-instance template="ServerTemplate">
```

```
        id="IceBoxServer"/>
    </node>
</application>
</icegrid>
```

The service template incorrectly refers to `id`, which is a parameter of the server template.

Modifying a Variable

A variable definition can be overridden in an inner scope, but the inner definition does not modify the outer variable. If a variable is defined multiple times in the same scope (which is only relevant in XML definitions), the most recent definition is used for all references to that variable. Consider the following example:

```
<application name="MyApp">
  <variable name="x" value="1"/>
  <variable name="y" value="{x}"/>
  <variable name="x" value="2"/>
  ...
</application>
```

When descriptors such as these are created, IceGrid validates their variable references but does not perform substitution until the descriptor is acted upon (such as when a node is generating a configuration file for a server). As a result, the value of `y` in the above example is 2 because that is the most recent definition of `x`.

37.16 Property Set Semantics

Ice servers and clients are configured with properties. For servers deployed with IceGrid, these properties are automatically generated into a configuration file from the information contained in the application descriptor. The settings in that configuration file are passed to server via the `--Ice.Config` command-line option.

Descriptors allow you to define property sets to efficiently manage and specify properties. Here are some of the benefits of using property sets:

- You can define sets of properties at the application or node element level and reference these properties in other property sets.
- You can specify properties for a specific server or service instance.

There are two kinds of property sets:

- Named property sets

Named property sets are defined at the application or node level. They are useful only as the target of references from other property sets. Specifically, a named property set has no effect unless you reference it from a `server` descriptor.

- Unnamed property sets

Unnamed property sets are defined at the `server`, `service`, `icebox`, `server-instance` or `service-instance` element level and define the properties for a server or service. Unnamed property sets can reference named property sets.

Named and unnamed property sets are defined with the same `properties` element. The context and the attributes of a `properties` element distinguish named property sets from unnamed property sets. Here is an example that defines a named and an unnamed property set:

```
<application name="App">
  <properties id="Debug">
    <property name="UseDebug" value="1"/>
  </properties>

  <node name="TheNode">
    <server id="TheServer" exe="./server">
      <properties>
        <property name="Identity" value="hello"/>
      </properties>
    </server>
  </node>
</application>
```

In this example, we define the named property set `UseDebug` and the unnamed property set of the server `TheServer`. The server configuration will contain only the `Identity` property because the server property set does not reference the `Debug` named property set.

The `properties` element is used to reference a named property set: if a `properties` element appears inside another `properties` element, it is a reference to another property set and it must specify the `refid` attribute. With the previous example, to reference the `Debug` property set, we would write the following:

```
<application name="App">
  <properties id="Debug">
    <property name="UseDebug" value="1"/>
  </properties>

  <node name="TheNode">
    <server id="TheServer" exe="./server">
      <properties>
        <properties refid="Debug"/>
        <property name="Identity" value="hello"/>
      </properties>
    </server>
  </node>
</application>
```

Property sets, whether named or unnamed, are evaluated as follows:

1. Within a `properties` element, IceGrid locates all references to named property sets and evaluates all property settings in the referenced property sets.
2. Explicit property definitions following any named references are then evaluated and added to the property set formed in the preceding step. This means that explicit property settings override corresponding settings in any referenced property sets.

It is illegal to define a reference to a property set after setting a property value, so references to property sets must precede property definitions. For example, the following is illegal:

```
<properties>
  <property name="Prop1" value="Value1"/>
  <properties refid="Ref1"/>
</properties>
```

Just as the order of the property definitions is important, the order of property set references is also important. For example, the following two property sets are not equivalent:

```
<properties>
  <properties refid="Ref1"/>
  <properties refid="Ref2"/>
</properties>
```

```
<properties>
  <properties refid="Ref2"/>
  <properties refid="Ref1"/>
</properties>
```

Named property sets are evaluated at the point of definition. If you reference other property sets or use variables in a named property set definition, you must make sure that the referenced property sets or variables are defined in the same scope. For example, the following is correct:

```
<application name="App">

  <variable name="level" value="1"/>

  <properties id="DebugApp">
    <property name="DebugLevel" value="${level}">
  </properties>

</application>
```

However, the following example is wrong because the `${level}` variable is not defined at the application scope:

```
<application name="App">

  <properties id="DebugApp">
    <property name="DebugLevel" value="${level}">
  </properties>

  <node name="TheNode">
    <variable name="level" value="1"/>
  </node>

</application>
```

If both the application and the node define the `${level}` variable, the value of the `${level}` variable in the `DebugApp` property set will be the value of the variable defined in the application descriptor.

So far, we have seen the definition of an unnamed property set only in a server descriptor. However, it is also possible to define an unnamed property set for server or service instances. This is a good way to specify or override properties specific to a server or service instance. For example:

```
<application name="TheApp">
  <server-template id="Template">

    <parameter name="instance-name"/>

    <server id="\${instance-name}" exe="./server">
      <properties>
        <property name="Timeout" value="30"/>
      </properties>
    </server>
  </server-template>

  <node name="TheNode">
    <server-instance template="Template" instance-name="MyInst">
      <properties>
        <property name="Debug" value="1"/>
        <property name="Timeout" value="-1"/>
      </properties>
    </server-instance>
  </node>
</application>
```

Here, the server instance overrides the `Timeout` property and defines an additional `Debug` property.

The server or service instance properties are evaluated as follows:

1. The unnamed property set from the template server or service descriptor is evaluated.
2. The unnamed property set from the server or service instance descriptor is evaluated and the resulting properties are added to the property set formed in the preceding step. This means that property settings in a server or service instance descriptor override corresponding settings in a template server or service descriptor.

The server or service instance unnamed property set and its parameters provide two different ways to customize the properties of a server or service template instance. It might not always be obvious which method to use: is it better to use a parameter to parameterize a given property or is it better to just specify it in the server or service instance property set?

For example, in the previous descriptor, we could have used a parameter with a default value for the `Timeout` property:

```
<application name="TheApp">
  <server-template id="Template">

    <parameter name="instance-name"/>
    <parameter name="timeout" default="30"/>

    <server id="{instance-name}" exe="./server">
      <properties>
        <property name="Timeout" value="{timeout}"/>
      </properties>
    </server>
  </server-template>

  <node name="TheNode">
    <server-instance template="Template"
      instance-name="MyInst" timeout="-1">
      <properties>
        <property name="Debug" value="1"/>
      </properties>
    </server-instance>
  </node>
</application>
```

Here are some guidelines to help you decide whether to use a parameter or a property:

- Use a parameter for a property that should always be set.
- Use a parameter if you want to make the property obvious to the reader and user of the template.
- Do not use a parameter for optional properties if you want to rely on a default value for the server.
- Do not use parameters for properties that are rarely used.

37.17 XML Features

IceGrid provides some convenient features to simplify the task of defining descriptors in XML.

37.17.1 Targets

An IceGrid XML file may contain optional definitions that are deployed only when specifically requested. These definitions are called targets and must be defined within a `target` element. The elements that may legally appear within a `target` element are determined by its enclosing element. For example, a `node` element is legal inside a `target` element of an `application` element, but not inside a `target` element of a `server` element. Each `target` element must define a value for the `name` attribute, but names are not required to be unique. Rather, targets should be considered as optional components or features of an application that are deployed in certain circumstances.

The example below defines targets named `debug` that, if requested during deployment, configure their servers with an additional property:

```
<icegrid>
  <application name="MyApp">
    <node name="Node">
      <server id="Server1" ...>
        <target name="debug">
          <property name="Ice.Trace.Network" value="2"/>
        </target>
      </server>
      ...
    </node>
  </application>
</icegrid>
```

Target names specified in an `icegridadmin` command (see Section 37.19.1) can be unqualified names like `debug`, in which case every target with that name is deployed, regardless of the target's nesting level. If you want to deploy targets more selectively, you can specify a fully-qualified name instead. A fully-qualified target name consists of its unqualified name prefaced by the names or identifiers of each enclosing element. For instance, a fully-qualified target name from the example above is `MyApp.Node.Server1.debug`.

37.17.2 Including Files

You can include the contents of another XML file into the current file using the `include` element, which is replaced with the contents of the included file. The elements in the included file must be enclosed in an `icegrid` element, as shown in the following example:

```
<!-- File: A.xml -->
<icegrid>
  <server-template id="ServerTemplate">
    <parameter name="id"/>
    ...
  </server-template>
</icegrid>

<!-- File: B.xml -->
<icegrid>
  <application name="MyApp">
    <include file="A.xml"/>
    <node name="Node">
      <server-instance template="ServerTemplate" .../>
    </node>
  </application>
</icegrid>
```

In `B.xml`, the `include` element identifies the name of the file to include using the `file` attribute. The top-level `icegrid` element is discarded from `A.xml` and its contents are inserted at the position of the `include` element in `B.xml`.

You can include specific targets (see Section 37.17.1) from a file by specifying their names in the optional `targets` attribute. If multiple targets are included, their names must be separated by whitespace. The example below illustrates the use of a target:

```
<!-- File: A.xml -->
<icegrid>
  <server-template id="ServerTemplate">
    <parameter name="id"/>
    ...
  </server-template>
  <target name="targetA">
    <server-template id="AnotherTemplate">
      ...
    </server-template>
  </target>
</icegrid>
```

```
<!-- File: B.xml -->
<icegrid>
  <application name="MyApp">
    <include file="A.xml" targets="targetA"/>
    <node name="Node">
      <server-instance template="ServerTemplate" .../>
      <server-instance template="AnotherTemplate" .../>
    </node>
  </application>
</icegrid>
```

37.18 Server Reference

37.18.1 icegridregistry

The IceGrid registry is a centralized repository of information, including deployed applications and well-known objects. A registry can optionally be collocated with an IceGrid node, which conserves resources and can be convenient during development and testing. The registry server is implemented by the **icegridregistry** executable.

Usage

The registry supports the following command-line options:

```
$ icegridregistry -h
Usage: icegridregistry [options]
Options:
-h, --help           Show this message.
-v, --version        Display the Ice version.
--nowarn             Don't print any security warnings.
```

The registry can optionally be run as a Unix daemon or Win32 service. On Unix, the following additional commands are supported:

```
--daemon           Run as a daemon.
--noclose          Do not close open file descriptors.
--nochdir         Do not change the current working directory.
```

On Windows, the following additional commands are supported:

```
--service NAME           Run as the Windows service NAME.

--install NAME [--display DISP] [--executable EXEC] [args]
    Install as Windows service NAME. If DISP is
    provided, use it as the display name,
    otherwise NAME is used. If EXEC is provided,
    use it as the service executable, otherwise
    this executable is used. Any additional
    arguments are passed unchanged to the
    service at startup.

--uninstall NAME        Uninstall Windows service NAME.

--start NAME [args]     Start Windows service NAME. Any additional
    arguments are passed unchanged to the
    service.

--stop NAME             Stop Windows service NAME.
```

Please see Section 8.3.2 for more information on these options.

Configuring Endpoints

The IceGrid registry creates up to four sets of endpoints, configured with the following properties:

- `IceGrid.Registry.Client.Endpoints`
Client-side endpoints supporting the `Ice::Locator`, `IceGrid::Query`, and `IceGrid::Registry` interfaces.
- `IceGrid.Registry.Server.Endpoints`
Server-side endpoints for object and object adapter registration.
- `IceGrid.Registry.Admin.Endpoints`
Administrative endpoints supporting the `IceGrid::Admin` and `Glacier2::SessionManager` interfaces (optional).
- `IceGrid.Registry.Internal.Endpoints`
Internal endpoints used by IceGrid nodes as well as the graphical administration tool to communicate with the registry. This property must be defined even if no nodes are being used.

See Appendix C for more information on these properties.

Access to an IceGrid registry's administrative interface should be restricted if the registry is running on an insecure host, such as an application firewall. The `IceGrid.Registry.Admin.Endpoints` property offers several alternatives:

- Disable administrative access completely by not defining the property.

- Block external access to the administrative endpoints defined by the property.
- Use only SSL endpoints in the property (see Chapter 40).

The method you choose depends on your deployment requirements. For example, if no administrative access is necessary, then the first technique is the most secure. If that is not feasible, then physically blocking (via a firewall) external access to the administrative endpoints is recommended. Finally, if a registry must be administered externally, then SSL endpoints should be used to ensure that only authenticated clients gain access.

Configuring a Data Directory

You must provide an empty directory in which the registry can initialize its databases. The pathname of this directory is supplied by the configuration property `IceGrid.Registry.Data`.

The files in this directory must not be edited manually, but rather indirectly using one of the administrative tools described in Section 37.19. To clear a registry's databases, first ensure the server is not currently running, then remove all of the files in its data directory and restart the server.

Minimal Configuration

The registry requires values for the three mandatory endpoint properties, as well as the data directory property, as shown in the following example:

```
IceGrid.Registry.Client.Endpoints=tcp -p 10000
IceGrid.Registry.Server.Endpoints=tcp
IceGrid.Registry.Internal.Endpoints=tcp
IceGrid.Registry.Data=/opt/ripper/registry
```

In addition, we also recommend defining `IceGrid.InstanceName`, which is discussed in Section 37.18.3.

Note that by omitting a definition for the administrative endpoints, we are denying the use of any administrative tool. Add a definition for the property `IceGrid.Registry.Admin.Endpoints` to allow administrative access.

The remaining configuration properties are discussed in Appendix C.

37.18.2 icegridnode

An IceGrid node is a process that activates, monitors, and deactivates registered server processes. You can run any number of nodes in a domain, but typically

there is one node per host. A node must be running on each host on which servers are activated automatically, and nodes cannot run without an IceGrid registry.

The IceGrid node server is implemented by the **icegridnode** executable. If you wish to run a registry and node in one process, **icegridnode** is the executable you must use.

Usage

The node supports the following command-line options:

Usage: icegridnode [options]

Options:

-h, --help Show this message.
 -v, --version Display the Ice version.
 --nowarn Don't print any security warnings.

--deploy DESCRIPTOR [TARGET1 [TARGET2 ...]]
 Add or update descriptor in file DESCRIPTOR,
 with optional targets.

The `--deploy` option allows an application to be deployed automatically as the node process starts, which can be especially useful during testing. The command expects the name of the XML deployment file, and optionally allows the names of the individual targets within the file to be specified.

The node can optionally be run as a Unix daemon or Win32 service. On Unix, the following additional commands are supported:

--daemon Run as a daemon.
 --noclose Do not close open file descriptors.
 --nochdir Do not change the current working directory.

On Windows, the following additional commands are supported:

--service NAME Run as the Windows service NAME.
 --install NAME [--display DISP] [--executable EXEC] [args]
 Install as Windows service NAME. If DISP is provided, use it as the display name, otherwise NAME is used. If EXEC is provided, use it as the service executable, otherwise this executable is used. Any additional arguments are passed unchanged to the service at startup.
 --uninstall NAME Uninstall Windows service NAME.

```
--start NAME [args]  Start Windows service NAME. Any additional
                      arguments are passed unchanged to the
                      service.
--stop NAME          Stop Windows service NAME.
```

See Section 8.3.2 for more information on these options.

Security Considerations

It is important that you give careful consideration to the permissions of the account under which the node runs. If the servers that the node will activate have no special access requirements, and all of the servers can use the same account, it is recommended that you do not run the node under an account with system privileges, such as the root account on Unix or the Administrator account on Windows. See Section 37.20.4 for more information on this subject.

Configuring Endpoints

The IceGrid node's endpoints are defined by the `IceGrid.Node.Endpoints` property and must be accessible to the registry. It is not necessary to use a fixed port because each node contacts the registry at startup to provide its current endpoint information.

Configuring a Data Directory

The node requires an empty directory that it can use to store server files. The path-name of this directory is supplied by the configuration property `IceGrid.Node.Data`. To clear a node's state, first ensure the server is not currently running, then remove all of the files in its data directory and restart the server.

When running a collocated node and registry server, we recommend using separate directories for the registry and node data directories.

Minimal Configuration

A minimal node configuration is shown in the following example:

```
IceGrid.Node.Endpoints=tcp
IceGrid.Node.Name=Node1
IceGrid.Node.Data=/opt/ripper/node
```

```
Ice.Default.Locator=IceGrid/Locator:tcp -p 10000
```

The value of the `IceGrid.Node.Name` property must match that of a deployed node known by the registry.

The `Ice.Default.Locator` property is used by the node to contact the registry. The value is a proxy that contains the registry's client endpoints (see Section 37.4.3).

If you wish to run a collocated registry and node server, add the property `IceGrid.Node.CollocateRegistry=1` and include the registry's configuration properties as described in Section 37.18.1.

The remaining configuration properties are discussed in Appendix C.

37.18.3 Object Identities

The IceGrid registry hosts several well-known objects. Table 37.24 shows the default identities of these objects and their corresponding Slice interfaces.

Table 37.24. IceGrid's well-known objects.

Default Identity	Interface
IceGrid/Registry	IceGrid::Registry
IceGrid/Locator	Ice::Locator
IceGrid/Admin	IceGrid::Admin
IceGrid/Query	IceGrid::Query
IceGrid/SessionManager	Glacier2::SessionManager
IceGrid/SSLSessionManager	Glacier2::SSLSessionManager
IceGrid/AdminSessionManager	Glacier2::SessionManager
IceGrid/AdminSSLSessionManager	Glacier2::SSLSessionManager
IceGrid/RegistryUserAccountMapper	IceGrid::UserAccountMapper

It is a good idea to assign unique identities to these objects by configuring them with different values for the `IceGrid.InstanceName` property, as shown in the following example:

```
IceGrid.InstanceName=MP3Grid
```

This property changes the identities of the well-known objects to use MP3Grid instead of IceGrid as the identity category. For example, the identity of the locator becomes MP3Grid/Locator.

The client's configuration must also be changed to reflect the new identity:

```
Ice.Default.Locator=MP3Grid/Locator:tcp -h registryhost -p 10000
```

Furthermore, any uses of these identities in application code must be updated as well.

37.19 Administrative Utilities

IceGrid provides two administrative clients: a command-line tool and a graphical application.

37.19.1 Command Line Client

The `icegridadmin` utility is a command-line tool for administering an IceGrid domain. Deploying an application with this utility requires an XML that defines the descriptors.

Usage

The IceGrid administration tool supports the following command-line options:

```
Usage: icegridadmin [options] [file...]
Options:
-h, --help           Show this message.
-v, --version        Display the Ice version.
-DNAME               Define NAME as 1.
-DNAME=DEF           Define NAME as DEF.
-UNAME               Remove any definition for NAME.
-IDIR                Put DIR in the include file search path.
-e COMMANDS          Execute COMMANDS.
-d, --debug          Print debug messages.
```

The `-e` option causes the tool to execute the given commands and then exit without entering an interactive session. Otherwise, the tool enters an interactive session; the `help` command displays the following usage information:

help

Print this message.

exit, quit

Exit this program.

application add [-n | --no-patch] DESC [TARGET ...]
[NAME=VALUE ...]

Add applications described in the XML descriptor file DESC. If specified the optional targets are deployed. Variables are defined using the NAME=VALUE syntax. The application is automatically patched unless the -n or --no-patch option is used to disable it (see Section 37.11).

application remove NAME

Remove the application named NAME.

application describe NAME

Describe the application named NAME.

application diff DESC [TARGET ...] [NAME=VALUE ...]

Print the differences between the application in the XML descriptor file DESC and the current deployment. Variables are defined using the NAME=VALUE syntax.

application update DESC [TARGET ...] [NAME=VALUE ...]

Update the application in the XML descriptor file DESC. Variables are defined using the NAME=VALUE syntax.

application patch [-f | --force] NAME

Patch the application named NAME. If -f or --force is specified, IceGrid will first shut down any servers that depend on the data to be patched.

application list

List all deployed applications.

server template instantiate APPLICATION NODE TEMPLATE
[NAME=VALUE ...]

Instantiate the requested server template defined in the given application on a node. Variables are defined using the NAME=VALUE syntax.

server template describe APPLICATION TEMPLATE

Describe a server template TEMPLATE from the given application.

service template describe APPLICATION TEMPLATE

Describe a service template TEMPLATE from the given application.

node list

List all registered nodes.

node describe NAME

Show information about node NAME.

node ping NAME

Ping node NAME.

node load NAME

Print the load of the node NAME.

node shutdown NAME

Shutdown node NAME.

server list

List all registered servers.

server remove ID

Remove server ID.

server describe ID

Describe server ID.

server state ID

Get the state of server ID.

server pid ID

Get the process id of server ID.

server start ID

Start server ID.

server stop ID

Stop server ID.

server patch ID

Patch server ID.

server signal ID SIGNAL

Send SIGNAL (e.g. SIGTERM or 15) to server NAME.

server stdout ID MESSAGE

Write MESSAGE on server NAME's stdout.

server stderr ID MESSAGE

Write MESSAGE on server NAME's stderr.

server enable ID

Enable server ID.

server disable ID

Disable server ID (a disabled server can't be started on demand or administratively).

adapter list

List all registered adapters.

adapter endpoints ID

Show the endpoints of adapter or replica group ID.

adapter remove ID

Remove adapter or replica group ID.

object add PROXY [TYPE]

Add a well-known object to the registry, optionally specifying its type.

object remove IDENTITY

Remove a well-known object from the registry.

object find TYPE

Find all well-known objects with the type TYPE.

object describe EXPR

Describe all well-known objects whose stringified identities match the expression EXPR. A trailing wildcard is supported in EXPR, for example "object describe Ice*".

object list EXPR

List all well-known objects whose stringified identities match the expression EXPR. A trailing wildcard is supported in EXPR, for example "object list Ice*".

shutdown

Shut the IceGrid registry down.

show copying

Show conditions for redistributing copies of this program.

show warranty

Show the warranty for this program.

Configuration

icegridadmin requires that the locator proxy be defined in the configuration property `Ice.Default.Locator`. If a configuration file already exists that defines this property, you can start **icegridadmin** using the configuration file as shown below:

```
$ icegridadmin --Ice.Config=<file>
```

Otherwise, you can define the property on the command line:

```
$ icegridadmin --Ice.Default.Locator=<proxy>
```

Section 37.4.4 describes how to configure the `Ice.Default.Locator` property for an IceGrid client.

37.19.2 Graphical Client

The graphical administration tool (**IceGrid.AdminGUI**) allows you to perform anything that you can do from the command line via a GUI. Please refer to the instructions included with your Ice distribution for details on how to set your **CLASSPATH** and how to start the administration tool.

37.20 Server Activation

You can choose among four activation modes for servers deployed and managed by an IceGrid node:

- manual

You must start the server explicitly via the IceGrid GUI or **icegridadmin**, or programmatically via the `IceGrid:Admin` interface.

- always

IceGrid activates the server when its node starts. If the server stops, IceGrid automatically reactivates it.

- on demand

IceGrid activates the server when a client invokes an operation on an object in the server.

- session

This mode also provides on-demand activation but requires the server to be allocated by a session.

37.20.1 Activation in Detail

On-demand server activation is a valuable feature of distributed computing architectures for a number of reasons:

- It minimizes application startup times by avoiding the need to pre-start all servers.
- It allows administrators to use their computing resources more efficiently because only those servers that are actually needed are running.
- It provides more reliability in the case of some server failure scenarios, e.g., the server is reactivated after a failure and may still be capable of providing some services to clients until the failure is resolved.

- It allows remote activation and deactivation.

On-demand activation occurs when an Ice client requests the endpoints of one of the server's object adapters via a locate request (see Section 37.3.1). If the server is not active at the time the client issues the request, the node activates the server and waits for the target object adapter to register its endpoints. Once the object adapter endpoints are registered, the registry returns the endpoint information back to the client. This sequence ensures that the client receives the endpoint information *after* the server is ready to receive requests.

37.20.2 Requirements

In order to use on-demand activation for an object adapter, the adapter must have an identifier and be entered in the IceGrid registry.

When using session activation mode, IceGrid requires that the server be allocated; on-demand activation fails for servers that have not been allocated. (See Section 37.10 for more information on server allocation.)

The session activation mode recognizes an additional reserved variable in the server descriptor, `session.id`. The value of this variable is the user ID or, for SSL sessions, the distinguished name associated with the session.

37.20.3 Efficiency

Once a server is activated, it remains running indefinitely (unless it uses the session activation mode). A node deactivates a server only when explicitly requested to do so (see Section 31.17.6). As a result, server processes tend to accumulate on the node's host.

One of the advantages of on-demand activation is the ability to manage computing resources more efficiently. Of course there are many aspects to this, but Ice makes one technique particularly simple: servers can be configured to terminate gracefully after they have been idle for a certain amount of time.

A typical scenario involves a server that is activated on demand, used for a while by one or more clients, and then terminated automatically when no requests have been made for a configurable number of seconds. All that is necessary is setting the server's configuration property `Ice.ServerIdleTime` to the desired idle time. See Appendix C for more information on this property.

For a server activated in session activation mode, IceGrid deactivates the server when the session releases the server or when the session is destroyed.

37.20.4 Activating Servers with Specific User IDs

On UNIX platforms you can activate server processes with specific effective user IDs, provided that the IceGrid node is running as root. If the IceGrid node does not run as root, servers are always activated with the effective user ID of the IceGrid node process. (The same is true for Windows—servers always run with the same user ID as the IceGrid node process.)

For the remainder of this section, we assume that the node runs as root on a UNIX machine.

The `user` attribute of the `server` descriptor specifies the user ID for a server. If this attribute is not specified and the activation mode is not `session`, the default value is `nobody`. Otherwise, the default value is `session.id` if the activation mode is `session`.

Since individual users often have different account names and user IDs on different machines, IceGrid provides a mechanism to map the value of the `user` attribute in the `server` descriptor to a user account. To do this, you must configure the node to use a user account mapper object. This object must implement the `IceGrid::UserAccountMapper` interface:

```
exception UserAccountNotFoundException {};
```

```
interface UserAccountMapper {
    string getUserAccount(string user)
        throws UserAccountNotFoundException;
};
```

The IceGrid node invokes `getUserAccount` and passes the value of the `server` descriptor's `user` attribute. The return value is the name of the user account.

IceGrid provides a built-in file-based user account mapper that you can configure for the node and the registry. The file contains any number of user-account-ID pairs. Each pair appears on a separate line, with white space separating the user account from the identifier. For example, the file shown below contains two entries that map two distinguished names to the user account `lisa`:

```
lisa O=ZeroC\\, Inc., OU=Ice, CN=Lisa
lisa O=ZeroC\\, Inc., OU=Ice, CN=Lisa S.
```

The distinguished names must be unique. If the same distinguished name appears several times in a file, the last entry is used.

You can specify the path of the user account file with the `IceGrid.Registry.UserAccounts` property for the registry and the `IceGrid.Node.UserAccounts` property for a node.

To configure an IceGrid node to use the IceGrid registry file-based user account mapper, you need to set the `IceGrid.Node.UserAccountMapper` property to the well-known proxy `IceGrid/RegistryUserAccountMapper`. Alternatively, you can set this property to the proxy of your own user account mapper object. Note that if this property is set, the node ignores the setting of `IceGrid.Node.UserAccounts`.

37.20.5 Endpoint Registration

Section 31.17.5 discusses the configuration requirements for enabling automatic endpoint registration in servers. It should be noted however that IceGrid simplifies the configuration process in two ways:

1. A server that is activated automatically by an IceGrid node does not need to explicitly configure a proxy for the locator because the IceGrid node defines it on the server's command-line.
2. The IceGrid deployment mechanism automates the creation of a configuration file for the server, including the definition of object adapter identifiers and endpoints (see Section 37.4.5).

37.21 Solving Problems

37.21.1 Activation Failure

Server activation failure is usually indicated by the receipt of a `NoEndpointException`. This can happen for a number of reasons, but the most likely cause is an incorrect configuration. For example, an IceGrid node may fail to activate a server because the server's executable file, shared libraries, or classes could not be found. There are several steps you can take in this case:

1. Enable activation tracing in the node by setting the configuration property `IceGrid.Node.Trace.Activator=3`.
2. Examine the tracing output and verify the server's command line and working directory are correct.
3. Relative pathnames specified in a command line may not be correct relative to the node's current working directory. Either replace relative pathnames with absolute pathnames, or restart the node in the proper working directory.

4. Verify that the server is configured with the correct `PATH` or `LD_LIBRARY_PATH` settings for its shared libraries. For a Java server, its `CLASSPATH` may also require changes.

Another cause of activation failure is a server fault during startup. After you have confirmed that the node successfully spawns the server process using the steps above, you should then check for signs of a server fault (e.g., on UNIX, look for a `core` file in the node's current working directory). See Section 37.21.3 for more information on server failures.

37.21.2 Proxy Failure

A client may receive `Ice::NotRegisteredException` if binding fails for an indirect proxy (see Section 31.17.2). This exception indicates that the proxy's object identity or object adapter is not known by the IceGrid registry. The following steps may help you discover the cause of the exception:

1. Use `icegridadmin` (see Section 37.19.1) to verify that the object identity or object adapter identifier is actually registered, and that it matches what is used by the proxy:

```
>>> adapter list
...
>>> object find ::Hello
...
```

2. If the problem persists, review your configuration to ensure that the locator proxy used by the client matches the registry's client endpoints, and that those endpoints are accessible to the client (i.e., are not blocked by a firewall).
3. Finally, enable locator tracing in the client by setting the configuration property `Ice.Trace.Location=2`, then run the client again to see if any log messages are emitted that may indicate the problem.

37.21.3 Server Failure

Diagnosing a server failure can be difficult, especially when servers are activated automatically on remote hosts. Here are a few suggestions:

1. If the server is running on a UNIX host, check the current working directory of the IceGrid node process for signs of a server failure, such as a `core` file.
2. Judicious use of tracing can help to narrow the search. For example, if the failure occurs as a result of an operation invocation, enable protocol tracing in

the Ice run time by setting the configuration property `Ice.Trace.Protocol=1` to discover the object identity and operation name of all requests.

Of course, the default log output channels (standard out and standard error) will probably be lost if the server is activated automatically, so either start the server manually (see below) or redirect the log output (see Appendix C for a description of the `Ice.UseSyslog` property).

You can also use the `Ice::Logger` interface to emit your own trace messages.

3. Run the server in a debugger; a server configured for automatic activation can also be started manually if necessary. However, since the IceGrid node did not activate the server, it cannot monitor the server process and therefore will not know when the server terminates. This will prevent subsequent activation unless you clean up the IceGrid state when you have finished debugging and terminated the server. You can do this by starting the server using `icegridadmin` (see Section 37.19.1):

```
>>> server start TheServer
```

This will cause the node to activate (and therefore monitor) the server process. If you do not want to leave the server running, you can stop it with the `server stop` command.

4. After the server is activated and is in a quiescent state, attach your debugger to the running server process. This avoids the issues associated with starting the server manually (as described in the previous step), but does not provide as much flexibility in customizing the server's startup environment.

Another cause for a server to fail to activate correctly is if there is a mismatch in the adapter names used by the server for its adapters, and the adapter names specified in the server's deployment descriptor. After starting a server process, the node waits for the server to activate all its object adapters and report them as ready; if the server does not do this, the node reports a failure after once a timeout expires. The timeout is controlled by the setting of the property `IceGrid.Node.WaitTime`. (The default value is 60 seconds.)

You can check the status of each of a server's adapters using `icegridadmin` or the GUI tool. While the node waits for an adapter to be activated by the server, it reports the status of the adapter as "activating". If you experience timeouts before each adapter's status changes to "active", the most likely cause is that the deployment descriptor for the server either mentions more object adapters than are actually created by the server, or that the server uses a name for

one or more adapters that does not match the corresponding name in the deployment descriptor.

37.21.4 Disabling Faulty Servers

You may find it necessary to disable a server that terminates in an error condition. For example, on a Unix platform each server failure might result in the creation of a new (and potentially quite large) core file. This problem is exacerbated when the server is used frequently, in which case repeated cycles of activation and failure can consume a great deal of disk space and threaten the viability of the application as a whole.

As a defensive measure, you can configure an IceGrid node to disable these servers automatically using the `IceGrid.Node.DisableOnFailure` property. In the disabled state, a server cannot be activated on demand. The default value of the property is zero, meaning the node does not disable a server that terminates improperly. A positive value causes the node to temporarily disable a faulty server, with the value representing the number of seconds the server should remain disabled. If the property has a negative value, the server is disabled indefinitely, or until the server is explicitly enabled or started via an administrative action.

37.22 Summary

This chapter provided a detailed discussion of IceGrid, including the modifications required to incorporate IceGrid into client and server applications, as well as the configuration and administration of IceGrid components. Once you understand the basic concepts on which IceGrid is founded, you quickly begin to appreciate the flexibility, power, and convenience of IceGrid's capabilities:

- Replication, load balancing and automatic server activation increase reliability and make more efficient use of processing resources.
- The location service simplifies administrative requirements and minimizes coupling between clients and servers.
- Deploying an application can be done using easily-understood, reusable XML files, or interactively using a graphical client.
- Distributing and updating executables, dependent libraries and other files on all nodes can be automated and managed remotely.

In short, IceGrid provides the tools you need to develop robust, enterprise-class Ice applications.

Chapter 38

Freeze

38.1 Chapter Overview

This chapter describes how to use Freeze to add persistence to Ice applications. Section 38.3 discusses the Freeze map and shows how to use it in a simple example. Section 38.4 examines an implementation of the file system using a Freeze map. Section 38.5 presents the Freeze evictor, and Section 38.6 demonstrates the Freeze evictor in another file system implementation.

38.2 Introduction

Freeze represents a set of persistence services, as shown in Figure 38.1.

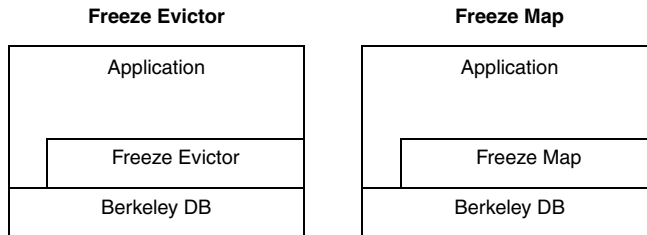

Figure 38.1. Layer diagram for Freeze persistence services.

The Freeze persistence services are described below:

- The Freeze evictor is a highly-scalable implementation of an Ice servant locator that provides automatic persistence and eviction of Ice objects with only minimal application code.
- The Freeze map is a generic associative container. Code generators are provided which produce type-specific maps for any Slice key and value types. Applications interact with a Freeze map just like any other associative container, except the keys and values of a Freeze map are persistent.

As you will see from the examples in this chapter, integrating a Freeze map or evictor into your Ice application is quite straightforward: once you define your persistent data in Slice, Freeze manages the mundane details of persistence.

Freeze is implemented using Berkeley DB, a compact and high-performance embedded database. The Freeze map and evictor APIs insulate applications from the Berkeley DB API, but do not prevent applications from interacting directly with Berkeley DB if necessary.

38.3 The Freeze Map

A Freeze map is a persistent, associative container in which the key and value types can be any primitive or user-defined Slice types. For each pair of key and value types, the developer uses a code-generation tool to produce a language-specific class that conforms to the standard conventions for maps in that language.

For example, in C++ the generated class resembles a `std::map`, and in Java it implements the `java.util.SortedMap` interface. Most of the logic for storing and retrieving state to and from the database is implemented in a Freeze base class. The generated map classes derive from this base class, so they contain little code and therefore are efficient in terms of code size.

You can only store data types that are defined in Slice in a Freeze map. Types without a Slice definition (that is, arbitrary C++ or Java types) cannot be stored because a Freeze map reuses the Ice-generated marshaling code to create the persistent representation of the data in the database. This is especially important to remember when defining a Slice class whose instances will be stored in a Freeze map; only the “public” (Slice-defined) data members will be stored, not the private state members of any derived implementation class.

38.3.1 Freeze Connections

In order to create a Freeze map object, you first need to obtain a Freeze Connection object by connecting to a database environment.

As illustrated in Figure 38.2, a Freeze map is associated with a single connection and a single database file. Connection and map objects are “single threaded”: if you want to use a connection or any of its associated maps from multiple threads, you must serialize access to them. If your application requires concurrent access to the same database file (persistent map), you must create several connections and associated maps.

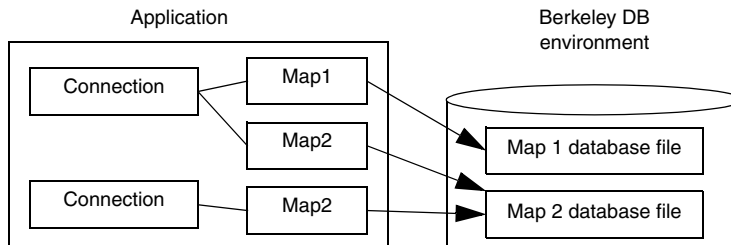

Figure 38.2. Freeze Connections and Maps.

38.3.2 Transactions

You may optionally use transactions with Freeze maps. Freeze transactions provide the usual ACID (atomicity, concurrency, isolation, durability) properties. For example, a transaction allows you to group several database updates in one atomic unit: either all or none of the updates within the transaction occur.

A transaction is started using the `beginTransaction` operation on the `Connection` object. Once a connection has an associated transaction, all operations on the map objects associated with this connection use this transaction. Eventually, you end the transaction by calling `commit` or `rollback`: `commit` saves all your updates while `rollback` undoes them.

```
module Freeze {

    local interface Transaction {
        void commit();
        void rollback();
    };

    local interface Connection {
        Transaction beginTransaction();
        nonmutating Transaction currentTransaction();
        // ...
    };
};
```

If you do not use transactions, every non-iterator update is enclosed in its own internal transaction, and every read-write iterator has an associated internal transaction which is committed when the iterator is closed.

38.3.3 Iterators

Iterators allow you to traverse the contents of a Freeze map. Iterators are implemented using Berkeley DB cursors and acquire locks on the underlying database page files. In C++, both read-only (`const_iterator`) and read-write iterators (`iterator`) are available; in Java only read-write iterators are supported.

Locks held by an iterator are released when the iterator is closed (if you do not use transactions) or when the enclosing transaction is ended. Releasing locks held by iterators is very important to let other threads access the database file through other connection and map objects. Occasionally it is even necessary to release locks to avoid self-deadlock (waiting forever for a lock held by an iterator created by the same thread).

To improve ease of use and make self-deadlocks less likely, Freeze often closes iterators automatically. If you close a map or connection, associated iterators are closed. Similarly, when you start or end a transaction, Freeze closes all the iterators associated with the corresponding maps. If you do not use transactions, any write operation on a map (such as inserting a new element) automatically closes all iterators opened on the same map object, except for the current iterator when the write operation is performed through that iterator.

There is, however, one situation where an explicit iterator close is needed to avoid self-deadlock:

- you do not use transactions, and
- you have an opened iterator that was used to update a map (it holds a write lock), and
- in the same thread, you read that map.

Read operations never close iterators automatically. In that situation, you need to either use transactions or explicitly close the iterator that holds the write lock.

38.3.4 Recovering from Deadlock Exceptions

If you use multiple threads to access a database file, Berkeley DB may acquire locks in conflicting orders (on behalf of different transactions or iterators). For example, an iterator could have a read-lock on page P1 and attempt to acquire a write-lock on page P2, while another iterator (on a different map object associated with the same database file) could have a read-lock on P2 and attempt to acquire a write-lock on P1.

When this occurs, Berkeley DB detects a deadlock and resolves it by returning a “deadlock” error to one or more threads. For all non-iterator operations performed outside any transaction, such as an insertion into a map, Freeze catches such errors and automatically retries the operation until it succeeds. (In that case, the most-recently acquired lock is released before retrying.) For other operations, Freeze reports this deadlock by raising `Freeze::DeadlockException`. In that case, the associated transaction or iterator is also automatically rolled back or closed. A properly written application is expected to catch deadlock exceptions and retry the transaction or iteration.

38.3.5 Indexing a Map

Freeze maps support efficient reverse lookups: if you define an index when you generate your map (with `slice2freeze` or `slice2freezej`), the generated

code provides additional methods for performing reverse lookups. If your value type is a structure or a class, you can also index on a member of the value, and several such indices can be associated with the same Freeze map.

Indexed searches are easy to use and very efficient. However, be aware that an index adds significant write overhead: with Berkeley DB, every update triggers a read from the database to get the old index entry and, if necessary, replace it.

If you later add an index to an existing map, Freeze automatically populates the index the next time the map is reopened. Freeze populates the index by instantiating each map entry, therefore it is important that you register the object factories for any class types in your map before you open the map.

38.3.6 Key Sorting

Keys in Freeze maps and indexes are always sorted. By default, Freeze sorts keys according to their Ice-encoded binary representation; it's very efficient but the resulting order is rarely meaningful for the application.

Starting with Ice 3.0, Freeze offers the ability to specify your own comparator objects. In C++, you specify these comparators as options to the `slice2freeze` utility (see below). In Java, the generated Java map class provides a number of constructors to accept these comparator objects.

The generated map provides the standard features from `std::map` (in C++) and `java.util.SortedMap` (in Java). Iterators return entries according to the order you have defined for the main key with your comparator object. In C++, `lower_bound`, `upper_bound` and `equal_range` provide range-searches; see the definition of these functions on `std::map`. In Java, use `headMap`, `tailMap` and `subMap` for range-searches; these methods come from the `java.util.SortedMap` interface

In addition to these standard features, the generated map provides additional functions and methods to perform range-searches using secondary keys. In C++, the additional functions are `lowerBoundForMember`, `upperBoundForMember` and `equalRangeForMember`, where *Member* is the name of the secondary-key member. These functions return regular iterators on the Freeze map.

In Java, the additional non-standard methods are:

```
public java.util.SortedMap
headMapForIndex(String indexName, Object toKey)

public java.util.SortedMap
tailMapForIndex(String indexName, Object fromKey)
```



```
public java.util.SortedMap
subMapForIndex(String indexName,
               Object fromKey,
               Object toKey)
```

The key of the returned submap is the secondary key (the index) and its value is a `java.util.Set` of `Map.Entry` objects from the main Freeze map. This set provides all the entries in the main Freeze map with the given secondary key. When iterating over this submap, you may need to close iterators explicitly, like with iterators obtained for the main Freeze map. See the Iterators section above.

38.3.7 `slice2freeze` Command-Line Options

The Slice-to-Freeze compiler, `slice2freeze`, offers the following command-line options in addition to the standard options described in Section 4.19:

- `--header-ext EXT`

Changes the file extension for the generated header files from the default `h` to the extension specified by `EXT`.

- `--source-ext EXT`

Changes the file extension for the generated source files from the default `cpp` to the extension specified by `EXT`.

- `--add-header HDR[, GUARD]`

This option adds an include directive for the specified header at the beginning of the generated source file (preceding any other include directives). If `GUARD` is specified, the include directive is protected by the specified guard. For example, `--add-header precompiled.h, __PRECOMPILED_H__` results in the following directives at the beginning of the generated source file:

```
#ifndef __PRECOMPILED_H__
#define __PRECOMPILED_H__
#include <precompiled.h>
#endif
```

The option can be repeated to create include directives for several files.

As suggested by the preceding example, this option is useful mainly to integrate the generated code with a compiler's precompiled header mechanism.

- **--include-dir *DIR***

Modifies `#include` directives in source files to prepend the pathname of each header file with the directory *DIR*. See Section 6.15.1 for more information.

- **--dll-export *SYMBOL***

Use *SYMBOL* to control DLL exports or imports. See the `slice2cpp` description for details.

- **--dict *NAME,KEY,VALUE* [, sort [, *COMPARE*]]**

Generate a Freeze map (C++ map) named *NAME* using *KEY* as key and *VALUE* as value. This option may be specified multiple times to generate several Freeze maps. *NAME* may be a scoped C++ name, such as `Demo::Struct1ObjectMap`. By default, keys are sorted using their binary Ice-encoded representation. Include `sort` to sort with the *COMPARE* functor class. If *COMPARE* is not specified, the default value is `std::less<KEY>`.

- **--dict-index *MAP* [, *MEMBER*] [, case-sensitive | case-insensitive] [, sort [, *COMPARE*]]**

Add an index to the Freeze map named *MAP*. If *MEMBER* is specified, then the map value type must be a structure or a class, and *MEMBER* must be a member of this structure or class. Otherwise, the entire value is indexed. When the indexed member (or entire value) is a string, the index can be case-sensitive (default) or case-insensitive. An index adds nine member functions to the generated C++ map:

```
iterator findByMEMBER(MEMBER_TYPE, bool = true);
const_iterator findByMEMBER(MEMBER_TYPE, bool = true) const;
iterator lowerBoundForMEMBER(MEMBER_TYPE);
const_iterator lowerBoundForMEMBER(MEMBER_TYPE) const;
iterator upperBoundForMEMBER(MEMBER_TYPE);
const_iterator upperBoundForMEMBER(MEMBER_TYPE) const;
std::pair<iterator, iterator>
equalRangeForMEMBER(MEMBER_TYPE);
std::pair<const_iterator, const_iterator>
equalRangeForMEMBER(MEMBER_TYPE) const;
int MEMBERCount(MEMBER_TYPE) const;
```

When *MEMBER* is not specified, these functions are `findByValue` (const and non-const), `lowerBoundForValue` (const and non-const), `value-`

Count etc. When **MEMBER** is specified, its first letter is capitalized in the `findBy` function name. **MEMBER_TYPE** corresponds to an in-parameter of the type of **MEMBER** (or the type of the value when **MEMBER** is not specified). For example, if **MEMBER** is a string, **MEMBER_TYPE** is a `const std::string&`.

By default, keys are sorted using their binary Ice-encoded representation. Include `sort` to sort with the **COMPARE** functor class. If **COMPARE** is not specified, the default value is `std::less<MEMBER_TYPE>`.

- `--index CLASS,TYPE,MEMBER[,case-sensitive|case-insensitive]`

Generate a Freeze Evictor Index (in C++). **CLASS** is the name of the class to be generated. **TYPE** denotes the type of class to be indexed (objects of different classes are not included in this index). **MEMBER** is the name of the data member in **TYPE** to index. When **MEMBER** has type `string`, it is possible to specify whether the index is case-sensitive or not. The default is case-sensitive. See Section 38.5.7 for more information.

Section 6.15.1 provides a discussion of the semantics of `#include` directives that is also relevant for users of `slice2freeze`.

38.3.8 `slice2freezej` Command-Line Options

The Slice-to-Freeze-for-Java compiler, `slice2freezej`, offers the following command-line options in addition to the standard options described in Section 4.19:

- `--dict NAME,KEY,VALUE`

Generate a Freeze map (Java map) named **NAME** using **KEY** as key and **VALUE** as value. This option may be specified multiple times to generate several Freeze dictionaries. **NAME** may be a scoped Java name, such as `Demo.Struct1ObjectMap`.

- `--dict-index MAP[,MEMBER] [,case-sensitive|case-insensitive]`

Add an index to the Freeze map named **MAP**. If **MEMBER** is specified, then the map value type must be a structure or a class, and **MEMBER** must be a member of this structure or class. Otherwise, the entire value is indexed. When the indexed member (or entire value) is a string, the index can be case-sensitive

(default) or case-insensitive. An index adds two methods to the generated Java map:

```
public Freeze.Map.Iterator findByMEMBER(MEMBER_TYPE) {...}
public int MEMBERCount(MEMBER_TYPE) {...}
```

When **MEMBER** is not specified, these functions are `findByValue` and `valueCount`. When **MEMBER** is specified, its first letter is capitalized in the `findBy` function name. **MEMBER_TYPE** corresponds to an in-parameter of the type of **MEMBER** (or the type of the value when **MEMBER** is not specified). For example, if **MEMBER** is a string, **MEMBER_TYPE** is a `java.lang.String`.

- **--index CLASS,TYPE,MEMBER[,case-sensitive|case-insensitive]**

Generate a Freeze Evictor Index (in Java). **CLASS** is the name of the class to be generated. **TYPE** denotes the type of class to be indexed (objects of different classes are not included in this index). **MEMBER** is the name of the data member in **TYPE** to index. When **MEMBER** has type `string`, it is possible to specify whether the index is case-sensitive or not. The default is case-sensitive. See Section 38.5.7 for more information.

- **--meta META**

Define the global metadata directive **META**. Using this option is equivalent to defining the global metadata **META** in each named Slice file, as well as in any file included by a named Slice file. See Section 10.15 for more information.

38.3.9 Using a Simple Map in C++

As an example, the following command generates a simple map:

```
$ slice2freeze --dict StringIntMap,string,int StringIntMap
```

The `slice2freeze` compiler creates C++ classes for Freeze maps. The command above directs the compiler to create a map named `StringIntMap`, with the Slice key type `string` and the Slice value type `int`. The final argument is the base name for the output files, to which the compiler appends the `.h` and `.cpp` suffixes. Therefore, this command produces two C++ source files: `StringIntMap.h` and `StringIntMap.cpp`.

Here is a simple program that demonstrates how to use a `StringIntMap` to store `<string, int>` pairs in a database. You will notice that there are no explicit `read` or `write` operations called by the program; instead, simply using the map has the side effect of accessing the database.

```
#include <Freeze/Freeze.h>
#include <StringIntMap.h>

int
main(int argc, char* argv[])
{
    // Initialize the Communicator.
    //
    Ice::CommunicatorPtr communicator =
        Ice::initialize(argc, argv);

    // Create a Freeze database connection.
    //
    Freeze::ConnectionPtr connection =
        Freeze::createConnection(communicator, "db");

    // Instantiate the map.
    //
    StringIntMap map(connection, "simple");

    // Clear the map.
    //
    map.clear();

    Ice::Int i;
    StringIntMap::iterator p;

    // Populate the map.
    //
    for (i = 0; i < 26; i++) {
        std::string key(1, 'a' + i);
        map.insert(make_pair(key, i));
    }

    // Iterate over the map and change the values.
    //
    for (p = map.begin(); p != map.end(); ++p)
        p.set(p->second + 1);

    // Find and erase the last element.
    //
    p = map.find("z");
    assert(p != map.end());
    map.erase(p);

    // Clean up.
```

```

    //
    connection->close();
    communicator->destroy();

    return 0;
}

```

Prior to instantiating a Freeze map, the application must connect to a Berkeley DB database environment.

```

Freeze::ConnectionPtr connection =
    Freeze::createConnection(communicator, "db");

```

The second argument is the name of a Berkeley DB database environment; by default, this is also the file system directory in which Berkeley DB creates all database and administrative files.

Next, the code instantiates the `StringIntMap` on the connection. The constructor's second argument supplies the name of the database file, which by default is created if it does not exist. Note that a database can only contain the persistent state of one map type. Any attempt to instantiate maps of different types on the same database results in undefined behavior.

```

StringIntMap map(connection, "simple");

```

Next, we clear the map. This ensures we have an empty map (and therefore an empty database) in case the program is run more than once.

```

map.clear();

```

We populate the map, using a single-character string as the key. The Freeze map supports several `insert` methods for adding entries, similar to a `std::map`. Insertion via operator `[]` is not supported.

```

for (i = 0; i < 26; i++) {
    std::string key(1, 'a' + i);
    map.insert(make_pair(key, i));
}

```

Iterating over the map will look familiar to `std::map` users. However, to modify a value at the iterator's current position, you must use the nonstandard `set` method:

```

for (p = map.begin(); p != map.end(); ++p)
    p.set(p->second + 1);

```

Next, the program obtains an iterator positioned at the element with key `z`, and erases it.

```
p = map.find("z");
assert(p != map.end());
map.erase(p);
```

Finally, the program closes the database connection, destroys its communicator and terminates.

```
connection->close();
```

It is not necessary to explicitly close the database connection, but we demonstrate it here for the sake of completeness.

38.3.10 Using a Simple Map in Java

As an example, the following command generates a simple map:

```
$ slice2freezej --dict StringIntMap,string,int
```

The `slice2freezej` compiler creates Java classes for Freeze maps. The command above directs the compiler to create a map named `StringIntMap`, with the Slice key type `string` and the Slice value type `int`. This command produces one Java source file: `StringIntMap.java`.

Here is a simple program that demonstrates how to use a `StringIntMap` to store `<string, int>` pairs in a database. You will notice that there are no explicit read or write operations called by the program; instead, simply using the map has the side effect of accessing the database.

```
public class Client
{
    public static void
    main(String[] args)
    {
        // Initialize the Communicator.
        //
        Ice.Communicator communicator = Ice.Util.initialize(args);

        // Create a Freeze database connection.
        //
        Freeze.Connection connection =
            Freeze.Util.createConnection(communicator, "db");

        // Instantiate the map.
        //
        StringIntMap map =
            new StringIntMap(connection, "simple", true);
```

```

        // Clear the map.
        //
        map.clear();

        int i;
        java.util.Iterator p;

        // Populate the map.
        //
        for (i = 0; i < 26; i++) {
            final char[] ch = { (char)('a' + i) };
            map.put(new String(ch), new Integer(i));
        }

        // Iterate over the map and change the values.
        //
        p = map.entrySet().iterator();
        while (p.hasNext()) {
            java.util.Map.Entry e = (java.util.Map.Entry)p.next();
            Integer in = (Integer)e.getValue();
            e.setValue(new Integer(in.intValue() + 1));
        }

        // Find and erase the last element.
        //
        boolean b;
        b = map.containsKey("z");
        assert(b);
        b = map.fastRemove("z");
        assert(b);

        // Clean up.
        //
        map.close();
        connection.close();
        communicator.destroy();

        System.exit(0);
    }
}

```

Prior to instantiating a Freeze map, the application must connect to the Berkeley DB database environment.

```

Freeze.Connection connection =
    Freeze.Util.createConnection(communicator, "db");

```

The second argument is the name of a Berkeley DB database environment; by default, this is also the file system directory in which Berkeley DB creates all database and administrative files.

Next, the code instantiates the `StringIntMap` on the connection. The constructor's second argument supplies the name of the database file, and the third argument is a flag indicating whether the database should be created if it does not exist. Note that a database can only contain the persistent state of one map type. Any attempt to instantiate maps of different types on the same database results in undefined behavior.

```
StringIntMap map = new StringIntMap(connection, "simple", true);
```

Next, we clear the map. This ensures we have an empty map (and therefore an empty database) in case the program is run more than once.

```
map.clear();
```

We populate the map, using a single-character string as the key. As with `java.util.Map`, the key and value types must be Java objects.

```
for (i = 0; i < 26; i++) {  
    final char[] ch = { (char)('a' + i) };  
    map.put(new String(ch), new Integer(i));  
}
```

Iterating over the map is no different from iterating over any other map that implements the `java.util.Map` interface:

```
p = map.entrySet().iterator();  
while (p.hasNext()) {  
    java.util.Map.Entry e =  
        (java.util.Map.Entry)p.next();  
    Integer in = (Integer)e.getValue();  
    e.setValue(new Integer(in.intValue() + 1));  
}
```

Next, the program verifies that an element exists with key `z`, and then removes it. Note that the program uses a non-standard method for removing the element. The `fastRemove` method differs from the standard `remove` method in that it does not return the value associated with the removed element; instead it returns a boolean indicating whether the element was found. By eliminating the need to return the element value, the method avoids the overhead of reading the value from the database and decoding it. The standard `remove` method could also be used here; we chose to use `fastRemove` instead simply to demonstrate its use:

```
b = map.containsKey("z");
assert(b);
b = map.fastRemove("z");
assert(b);
```

Finally, the program closes the map and its connection.

```
map.close();
connection.close();
```

38.4 Using a Freeze Map in the File System Server

We can use a Freeze map to add persistence to the file system server, and we present C++ and Java implementations in this section. However, as you will see in Section 38.5, a Freeze evictor is often a better choice for applications (such as the file system server) in which the persistent value is an Ice object.

In general, incorporating a Freeze map into your application requires the following steps:

1. Evaluate your existing Slice definitions for suitable key and value types.
2. If no suitable key or value types are found, define new (possibly derived) types that capture your persistent state requirements. Consider placing these definitions in a separate file: these types are only used by the server for persistence, and therefore do not need to appear in the “public” definitions required by clients. Also consider placing your persistent types in a separate module to avoid name clashes.
3. Generate a Freeze map for your persistent types using the Freeze compiler.
4. Use the Freeze map in your operation implementations.

38.4.1 Choosing Key and Value Types

Our goal is to implement the file system using a Freeze map for all persistent storage, including files and their contents. Our first step is to select the Slice types we will use for the key and value types of our map. We will keep the same basic design as in XREF, therefore we need a suitable representation for persistent files and directories, as well as a unique identifier for use as a key.

Conveniently enough, Ice objects already have a unique identifier of type `Ice::Identity`, and this will do fine as the key type for our map.

Unfortunately, the selection of a value type is more complicated. Looking over the `Filesystem` module in XREF, we do not find any types that capture all of our persistent state, so we need to extend the module with some new types:

```
module Filesystem {
    class PersistentNode {
        string name;
    };

    class PersistentFile extends PersistentNode {
        Lines text;
    };

    class PersistentDirectory extends PersistentNode {
        NodeDict nodes;
    };
};
```

Our Freeze map will therefore map from `Ice::Identity` to `PersistentNode`, where the values are actually instances of the derived classes `PersistentFile` or `PersistentDirectory`. If we had followed the advice at the beginning of Section 38.4, we would have defined `File` and `Directory` classes in a separate `PersistentFilesystem` module, but in this example we use the existing `Filesystem` module for the sake of simplicity.

38.4.2 Implementing the File System Server in C++

In this section we present a C++ file system implementation that utilizes a Freeze map for persistent storage. The implementation is based on the one discussed in XREF, and, in this section, we only discuss code that illustrates use of the Freeze map.

Generating the Map

Now that we have selected our key and value types, we can generate the map as follows:

```
$ slice2freeze -I$(ICE_HOME)/slice --dict \
    IdentityNodeMap,Ice::Identity,Filesystem::PersistentNode\
    IdentityNodeMap Filesystem.ice \
    $(ICE_HOME)/slice/Ice/Identity.ice
```

The resulting map class is named `IdentityNodeMap`.

The Server main Program

The server's main program is responsible for initializing the root directory node. Many of the administrative duties, such as creating and destroying a communicator, are handled by the class `Ice::Application`, as described in Section 8.3.1. Our server main program has now become the following:

```
#include <FilesystemI.h>
#include <Ice/Application.h>
#include <Freeze/Freeze.h>

using namespace std;
using namespace Filesystem;

class FilesystemApp : public virtual Ice::Application {
public:
    FilesystemApp(const string& envName) :
        _envName(envName) { }

    virtual int run(int, char*[]) {
        // Terminate cleanly on receipt of a signal
        //
        shutdownOnInterrupt();

        // Install object factories
        //
        communicator()->addObjectFactory(
            PersistentFile::ice_factory(),
            PersistentFile::ice_staticId());

        communicator()->addObjectFactory(
            PersistentDirectory::ice_factory(),
            PersistentDirectory::ice_staticId());

        // Create an object adapter (stored in the NodeI::_adapter
        // static member)
        //
        NodeI::_adapter = communicator()->
            createObjectAdapterWithEndpoints(
                "FreezeFilesystem", "default -p 10000");

        //
        // Set static members used to create connections and maps
        //
        NodeI::_communicator = communicator();
        NodeI::_envName = _envName;
    }
};
```

```

NodeI::_dbName = "mapfs";

// Find the persistent node for the root directory, or
// create it if not found
//
Freeze::ConnectionPtr connection =
    Freeze::createConnection(communicator(), _envName);
IdentityNodeMap persistentMap(connection, NodeI::_dbName);

Ice::Identity rootId = communicator()->stringToIdentity("R
ootDir");
PersistentDirectoryPtr pRoot;
{
    IdentityNodeMap::iterator p =
        persistentMap.find(rootId);

    if (p != persistentMap.end()) {
        pRoot =
            PersistentDirectoryPtr::dynamicCast(
                p->second);
        assert(pRoot);
    } else {
        pRoot = new PersistentDirectory;
        pRoot->name = "/";
        persistentMap.insert(
            IdentityNodeMap::value_type(rootId, pRoot));
    }
}

// Create the root directory (with name "/" and no parent)
//
DirectoryIPtr root = new DirectoryI(rootId, pRoot, 0);

// Ready to accept requests now
//
NodeI::_adapter->activate();

// Wait until we are done
//
communicator()->waitForShutdown();
if (interrupted()) {
    cerr << appName()
         << ": received signal, shutting down" << endl;
}

return 0;

```

```

    }

private:
    string _envName;

};

int
main(int argc, char* argv[])
{
    FilesystemApp app("db");
    return app.main(argc, argv);
}

```

Let us examine the changes in detail. First, we are now including `Freeze/Freeze.h` instead of `Ice/Ice.h`. This `Freeze` header file includes all of the other `Freeze` (and `Ice`) header files this source file requires.

Next, we define the class `FilesystemApp` as a subclass of `Ice::Application`, and provide a constructor taking a string argument:

```

FilesystemApp(const string& envName) :
    _envName(envName) { }

```

The string argument represents the name of the database environment, and is saved for later use in `run`.

One of the first tasks `run` performs is installing the `Ice` object factories for `PersistentFile` and `PersistentDirectory`. Although these classes are not exchanged via `Slice` operations, they are marshalled and unmarshalled in exactly the same way when saved to and loaded from the database, therefore factories are required. Since these `Slice` classes have no operations, we can use their built-in factories.

```

communicator()->addObjectFactory(
    PersistentFile::ice_factory(),
    PersistentFile::ice_staticId());

communicator()->addObjectFactory(
    PersistentDirectory::ice_factory(),
    PersistentDirectory::ice_staticId());

```

Next, we set all the `NodeI` static members.

```

NodeI::_adapter = communicator()->
    createObjectAdapterWithEndpoints(
        "FreezeFilesystem", "default -p 10000");

NodeI::_communicator = communicator();
NodeI::_envName = _envName;
NodeI::_dbName = "mapfs";

```

Then we create a Freeze connection and a Freeze map. When the last connection to a Berkeley DB environment is closed, Freeze automatically closes this environment, so keeping a connection in the main function ensures the underlying Berkeley DB environment remains open. Likewise, we keep a map in the main function to keep the underlying Berkeley DB database open.

```

Freeze::ConnectionPtr connection =
    Freeze::createConnection(communicator(), _envName);
IdentityNodeMap persistentMap(connection, NodeI::_dbName);

```

Now we need to initialize the root directory node. We first query the map for the identity of the root directory node; if no match is found, we create a new `PersistentDirectory` instance and insert it into the map. We use a scope to close the iterator after use; otherwise, this iterator could keep locks and prevent subsequent access to the map through another connection.

```

Ice::Identity rootId = communicator()->stringToIdentity("R
ootDir");
PersistentDirectoryPtr pRoot;
{
    IdentityNodeMap::iterator p =
        persistentMap.find(rootId);

    if (p != persistentMap.end()) {
        pRoot =
            PersistentDirectoryPtr::dynamicCast(
                p->second);
        assert(pRoot);
    } else {
        pRoot = new PersistentDirectory;
        pRoot->name = "/";
        persistentMap.insert(
            IdentityNodeMap::value_type(rootId, pRoot));
    }
}

```

Finally, the main function instantiates the `FilesystemApp`, passing `db` as the name of the database environment.

```

int
main(int argc, char* argv[])
{
    FilesystemApp app("db");
    return app.main(argc, argv);
}

```

The Servant Class Definitions

We also must change the servant classes to incorporate the Freeze map. We are maintaining the multiple-inheritance design from XREF, but we have added some methods and changed the constructor arguments and state members.

Let us examine the definition of NodeI first. You will notice the addition of the `getPersistentNode` method, which allows NodeI to gain access to the persistent node in order to implement the Node operations. Another alternative would have been to add a `PersistentNodePtr` member to NodeI, but that would have forced the `FileI` and `DirectoryI` classes to downcast this member to the appropriate subclass.

```

namespace Filesystem {
    class NodeI : virtual public Node {
    public:
        // ... Ice operations ...
        static Ice::ObjectAdapterPtr _adapter;
        static Ice::CommunicatorPtr _communicator;
        static std::string _envName;
        static std::string _dbName;
    protected:
        NodeI(const Ice::Identity&, const DirectoryIPtr&);
        virtual PersistentNodePtr getPersistentNode() const = 0;
        PersistentNodePtr find(const Ice::Identity&) const;
        IdentityNodeMap _map;
        DirectoryIPtr _parent;
        IceUtil::RecMutex _nodeMutex;
        bool _destroyed;
    public:
        const Ice::Identity _ID;
    };
}

```

Other changes of interest in NodeI are the addition of the members `_map` and `_destroyed`, and we have changed the NodeI constructor to accept an `Ice::Identity` argument.

The `FileI` class now has a single state member of type `PersistentFilePtr`, representing the persistent state of this file. Its constructor has also changed to accept `Ice::Identity` and `PersistentFilePtr`.

```
namespace Filesystem {
    class FileI : virtual public File,
                 virtual public NodeI {
    public:
        // ... Ice operations ...
        FileI(const Ice::Identity&, const PersistentFilePtr&,
             const DirectoryIPtr&);
    protected:
        virtual PersistentNodePtr getPersistentNode() const;
    private:
        PersistentFilePtr _file;
    };
}
```

The `DirectoryI` class has undergone a similar transformation.

```
namespace Filesystem {
    class DirectoryI : virtual public Directory,
                     virtual public NodeI {
    public:
        // ... Ice operations ...
        DirectoryI(const Ice::Identity&,
                 const PersistentDirectoryPtr&,
                 const DirectoryIPtr&);

        // ...
    protected:
        virtual PersistentNodePtr getPersistentNode() const;
        // ...
    private:
        // ...
        PersistentDirectoryPtr _dir;
    };
}
```

Implementing `FileI`

Let us examine how the implementations have changed. The `FileI` methods are still fairly trivial, but there are a few aspects that need discussion.

First, each operation now checks the `_destroyed` member and raises `Ice::ObjectNotExistException` if the member is `true`. This is necessary in order to ensure that the Freeze map is kept in a consistent state. For example, if we allowed the `write` operation to proceed after the file node had been destroyed,

```

        NodeI(id, parent), _file(file)
    {
    }

    Filesystem::PersistentNodePtr
    Filesystem::FileI::getPersistentNode() const
    {
        return _file;
    }

```

Implementing DirectoryI

The `DirectoryI` implementation requires more substantial changes. We begin our discussion with the `createDirectory` operation.

```

    Filesystem::DirectoryI::createDirectory(
        const std::string& name,
        const Ice::Current& current)
    {
        IceUtil::RWRecMutex::WLock lock(_nodeMutex);

        if (!_destroyed)
            throw Ice::ObjectNotExistException(__FILE__, __LINE__);

        checkName(name);

        PersistentDirectoryPtr persistentDir
            = new PersistentDirectory;
        persistentDir->name = name;
        DirectoryIPtr dir = new DirectoryI(
            communicator()->stringToIdentity(IceUtil::generateUUID()),

            persistentDir, this);
        assert(find(dir->_ID) == 0);
        _map.put(make_pair(dir->_ID, persistentDir));

        DirectoryPrx proxy = DirectoryPrx::uncheckedCast(
            current.adapter->createProxy(dir->_ID));

        NodeDesc nd;
        nd.name = name;
        nd.type = DirType;
        nd.proxy = proxy;
        _dir->nodes[name] = nd;
    }

```

```

        _map.put(IdentityNodeMap::value_type(_ID, _dir));

    return proxy;
}

```

After validating the node name, the operation creates a `PersistentDirectory`¹ object for the child directory, which is passed to the `DirectoryI` constructor along with a unique identity. Next, we store the child's `PersistentDirectory` object in the Freeze map. Finally, we initialize a new `NodeDesc` value and insert it into the parent's node table and then reinsert the parent's `PersistentDirectory` object into the Freeze map.

The implementation of the `createFile` operation has the same structure as `createDirectory`.

```

Filesystem::FilePrx
Filesystem::DirectoryI::createFile(const std::string& name,
                                   const Ice::Current& current)
{
    IceUtil::RWRecMutex::WLock lock(_nodeMutex);

    if (_destroyed)
        throw Ice::ObjectNotExistException(__FILE__, __LINE__);

    checkName(name);

    PersistentFilePtr persistentFile = new PersistentFile;
    persistentFile->name = name;
    FileIPtr file = new FileI(
        communicator()->stringToIdentity(IceUtil::generateUUID()),

        persistentFile, this);
    assert(find(file->_ID) == 0);
    _map.put(make_pair(file->_ID, persistentFile));

    FilePrx proxy = FilePrx::uncheckedCast(
        current.adapter->createProxy(file->_ID));

    NodeDesc nd;
    nd.name = name;
    nd.type = FileType;
}

```

1. Since this Slice class has no operations, the compiler generates a concrete class that an application can instantiate.

```

        nd.proxy = proxy;
        _dir->nodes[name] = nd;
        _map.put(IdentityNodeMap::value_type(_ID, _dir));

    return proxy;
}

```

The next significant change is in the `DirectoryI` constructor. The body of the constructor now instantiates all of its immediate children, which effectively causes all nodes to be instantiated recursively.

For each entry in the directory's node table, the constructor locates the matching entry in the Freeze map. The key type of the Freeze map is `Ice::Identity`, so the constructor obtains the key by invoking `ice_getIdentity` on the child's proxy.

```

Filesystem::DirectoryI::DirectoryI(
    const Ice::Identity& id,
    const PersistentDirectoryPtr& dir,
    const DirectoryIPtr& parent) :
    NodeI(id, parent), _dir(dir)
{
    // Instantiate the child nodes
    //
    for (NodeDict::iterator p = dir->nodes.begin();
         p != dir->nodes.end(); ++p) {
        Ice::Identity id = p->second.proxy->ice_getIdentity();
        PersistentNodePtr node = find(id);
        assert(node != 0);
        if (p->second.type == DirType) {
            PersistentDirectoryPtr pDir =
                PersistentDirectoryPtr::dynamicCast(node);
            assert(pDir);
            DirectoryIPtr d = new DirectoryI(id, pDir, this);
        } else {
            PersistentFilePtr pFile =
                PersistentFilePtr::dynamicCast(node);
            assert(pFile);
            FileIPtr f = new FileI(id, pFile, this);
        }
    }
}

```

If it seems inefficient for the `DirectoryI` constructor to immediately instantiate all of its children, you are right. This clearly will not scale well to large node trees, so why are we doing it?

Previous implementations of the file system service returned transient proxies from `createDirectory` and `createFile`. In other words, if the server was stopped and restarted, any existing child proxies returned by the old instance of the server would no longer work. However, now that we have a persistent store, we should endeavor to ensure that proxies will remain valid across server restarts. There are a couple of implementation techniques that satisfy this requirement:

1. Instantiate all of the servants in advance, as shown in the `DirectoryI` constructor.
2. Use a servant locator.

We chose not to include a servant locator in this example because it complicates the implementation and, as we will see in Section 38.5, a Freeze evictor is ideally suited for this application and a better choice than writing a servant locator.

The last `DirectoryI` method we discuss is `removeChild`, which removes the entry from the node table, and then reinserts the `PersistentDirectory` object into the map to make the change persistent.

```
void
Filesystem::DirectoryI::removeChild(const string& name)
{
    IceUtil::RecMutex::Lock lock(_nodeMutex);

    _dir->nodes.erase(name);
    _map.put(IdentityNodeMap::value_type(_ID, _dir));
}
```

Implementing NodeI

There are a few changes to the `NodeI` implementation that should be mentioned. First, you will notice the use of `getPersistentNode` in order to obtain the node's name. We could have simply invoked the `name` operation, but that would incur the overhead of another mutex lock.

Then, the `destroy` operation removes the node from the Freeze map and sets the `_destroyed` member to true.

The `NodeI` constructor no longer computes a value for the identity. This is necessary in order to make our servants truly persistent. Specifically, the identity for a node is computed once when that node is created, and must remain the same for the lifetime of the node. The `NodeI` constructor therefore must not compute a new identity, but rather simply remember the identity that is given to it. The `NodeI` constructor also constructs the map object (`_map` data member).

Remember this object is single-threaded: we use it only in constructors or when we have a write lock on the recursive read-write `_nodeMutex`.

Finally, the `find` function illustrates what needs to be done when iterating over a database that multiple threads can use concurrently. `find` catches `Freeze::DeadlockException` and retries.

```
std::string
filesystem::NodeI::name(const Ice::Current&) const
{
    IceUtil::RecMutex::Lock lock(_nodeMutex);

    if (_destroyed)
        throw Ice::ObjectNotExistException(__FILE__, __LINE__);

    return getPersistentNode()->name;
}

void
filesystem::NodeI::destroy(const Ice::Current& current)
{
    IceUtil::RWRecMutex::WLock lock(_nodeMutex);

    if (_destroyed)
        throw Ice::ObjectNotExistException(__FILE__, __LINE__);

    if (!_parent) {
        filesystem::PermissionDenied e;
        e.reason = "cannot remove root directory";
        throw e;
    }

    _parent->removeChild(getPersistentNode()->name);
    _map.erase(current.id);
    current.adapter->remove(current.id);
    _destroyed = true;
}

filesystem::NodeI::NodeI(const Ice::Identity& id,
                        const DirectoryIPtr& parent)
: _map(Freeze::createConnection(_communicator, _envName),
      _dbName),
  _parent(parent), _destroyed(false), _ID(id)
{
    // Add the identity of self to the object adapter
```

```

        //
        _adapter->add(this, _ID);
    }

    Filesystem::PersistentNodePtr
    Filesystem::NodeI::find(const Ice::Identity& id) const
    {
        for(;;) {
            try {
                IdentityNodeMap::const_iterator p = _map.find(id);
                if(p == _map.end())
                    return 0;
                else
                    return p->second;
            }
            catch(const Freeze::DeadlockException&) {
                // Try again
                //
            }
        }
    }
}

```

38.4.3 Implementing the File System Server in Java

In this section we present a Java file system implementation that utilizes a Freeze map for persistent storage. The implementation is based on the one discussed in XREF; in this section we only discuss code that illustrates use of the Freeze map.

Generating the Map

Now that we have selected our key and value types, we can generate the map as follows:

```

$ slice2freezej -I$(ICE_HOME)/slice --dict \
    Filesystem.IdentityNodeMap,Ice::Identity,\
    Filesystem::PersistentNode\
    Filesystem.ice $(ICE_HOME)/slice/Ice/Identity.ice

```

The resulting map class is named `IdentityNodeMap` and is defined in the package `Filesystem`².

The Server main Program

The server's main program is responsible for initializing the root directory node. Many of the administrative duties, such as creating and destroying a communi-

cator, are handled by the class `Ice.Application` as described in Section 12.3.1. Our server main program has now become the following:

```
import Filesystem.*;

public class Server extends Ice.Application {
    public
    Server(String envName)
    {
        _envName = envName;
    }

    public int
    run(String[] args)
    {
        // Install object factories
        //
        communicator().addObjectFactory(
            PersistentFile.ice_factory(),
            PersistentFile.ice_staticId());
        communicator().addObjectFactory(
            PersistentDirectory.ice_factory(),
            PersistentDirectory.ice_staticId());

        // Create an object adapter (stored in the _adapter
        // static member)
        //
        Ice.ObjectAdapter adapter =
            communicator().createObjectAdapterWithEndpoints(
                "FreezeFilesystem", "default -p 10000");
        DirectoryI._adapter = adapter;
        FileI._adapter = adapter;

        //
        // Set static members used to create connections and maps
        //
        String dbName = "mapfs";
        DirectoryI._communicator = communicator();
        DirectoryI._envName = _envName;
        DirectoryI._dbName = dbName;
    }
}
```

-
2. We cannot generate `IdentityNodeMap` in the unnamed (top-level) package because Java's name resolution rules would prevent the implementation classes in the `Filesystem` package from using it. See the Java Language Specification for more information.

```
FileI._communicator = communicator();
FileI._envName = _envName;
FileI._dbName = dbName;

// Find the persistent node for the root directory. If
// it doesn't exist, then create it.
Freeze.Connection connection =
    Freeze.Util.createConnection(
        communicator(), _envName);
IdentityNodeMap persistentMap =
    new IdentityNodeMap(connection, dbName, true);

Ice.Identity rootId =
    Ice.Util.stringToIdentity("RootDir");
PersistentDirectory pRoot =
    (PersistentDirectory)persistentMap.get(rootId);
if(pRoot == null)
{
    pRoot = new PersistentDirectory();
    pRoot.name = "/";
    pRoot.nodes = new java.util.HashMap();
    persistentMap.put(rootId, pRoot);
}

// Create the root directory (with name "/" and no parent)
//
DirectoryI root = new DirectoryI(rootId, pRoot, null);

// Ready to accept requests now
//
adapter.activate();

// Wait until we are done
//
communicator().waitForShutdown();

// Clean up
//
connection.close();

return 0;
}

public static void
main(String[] args)
{
```

```

        Server app = new Server("db");
        app.main("Server", args);
        System.exit(0);
    }

    private String _envName;
}

```

Let us examine the changes in detail. First, we define the class `Server` as a subclass of `Ice.Application`, and provide a constructor taking a string argument:

```

public
Server(String envName)
{
    _envName = envName;
}

```

The string argument represents the name of the database environment, and is saved for later use in run.

One of the first tasks run performs is installing the Ice object factories for `PersistentFile` and `PersistentDirectory`. Although these classes are not exchanged via Slice operations, they are marshalled and unmarshalled in exactly the same way when saved to and loaded from the database, therefore factories are required. Since these Slice classes have no operations, we can use their built-in factories.

```

communicator().addObjectFactory(
    PersistentFile.ice_factory(),
    PersistentFile.ice_staticId());
communicator().addObjectFactory(
    PersistentDirectory.ice_factory(),
    PersistentDirectory.ice_staticId());

```

Next, we set all the `DirectoryI` and `FileI` static members.

```

Ice.ObjectAdapter adapter =
    communicator().createObjectAdapterWithEndpoints(
        "FreezeFilesystem", "default -p 10000");
DirectoryI._adapter = adapter;
FileI._adapter = adapter;

String dbName = "mapfs";
DirectoryI._communicator = communicator();
DirectoryI._envName = _envName;

```

```

DirectoryI._dbName = dbName;
FileI._communicator = communicator();
FileI._envName = _envName;
FileI._dbName = dbName;

```

Then we create a Freeze connection and a Freeze map. When the last connection to a Berkeley DB environment is closed, Freeze automatically closes this environment, so keeping a connection in the main function ensures the underlying Berkeley DB environment remains open. Likewise, we keep a map in the main function to keep the underlying Berkeley DB database open.

```

Freeze.Connection connection =
    Freeze.Util.createConnection(
        communicator(), _envName);
IdentityNodeMap persistentMap =
    new IdentityNodeMap(connection, dbName, true);

```

Now we need to initialize the root directory node. We first query the map for the identity of the root directory node; if no match is found, we create a new `PersistentDirectory` instance and insert it into the map.

```

Ice.Identity rootId =
    Ice.Util.stringToIdentity("RootDir");
PersistentDirectory pRoot =
    (PersistentDirectory)persistentMap.get(rootId);
if(pRoot == null)
{
    pRoot = new PersistentDirectory();
    pRoot.name = "/";
    pRoot.nodes = new java.util.HashMap();
    persistentMap.put(rootId, pRoot);
}

```

Finally, the main function instantiates the `Server` class, passing `db` as the name of the database environment.

```

public static void
main(String[] args)
{
    Server app = new Server("db");
    app.main("Server", args);
    System.exit(0);
}

```

The Servant Class Definitions

We also must change the servant classes to incorporate the Freeze map. We are maintaining the design from XREF, but we have added some methods and changed the constructor arguments and state members.

The `FileI` class has three new static members, `_communicator`, `_envName` and `_dbName`, that are used to instantiate the new `_connection` (a Freeze connection) and `_map` (an `IdentityNodeMap`) members in each `FileI` object. We keep the connection so that we can close it explicitly when we no longer need it.

The class also has a new instance member of type `PersistentFile`, representing the persistent state of this file, and a `boolean` member to indicate whether the node has been destroyed. Finally, we have changed its constructor to accept `Ice.Identity` and `PersistentFile`.

```
package Filesystem;

public class FileI extends _FileDisp
{
    public
    FileI(Ice.Identity id, PersistentFile file, DirectoryI parent)
    {
        // ...
    }

    // ... Ice operations ...

    public static Ice.ObjectAdapter _adapter;
    public static Ice.Communicator _communicator;
    public static String _envName;
    public static String _dbName;
    public Ice.Identity _ID;
    private Freeze.Connection _connection;
    private IdentityNodeMap _map;
    private PersistentFile _file;
    private DirectoryI _parent;
    private boolean _destroyed;
}
```

The `DirectoryI` class has undergone a similar transformation.

```
package Filesystem;

public final class DirectoryI extends _DirectoryDisp
{
```

```

public
DirectoryI(Ice.Identity id, PersistentDirectory dir,
           DirectoryI parent)
{
    // ...
}

// ... Ice operations ...

public static Ice.ObjectAdapter _adapter;
public static Ice.Communicator _communicator;
public static String _envName;
public static String _dbName;
public Ice.Identity _ID;
private Freeze.Connection _connection;
private IdentityNodeMap _map;
private PersistentDirectory _dir;
private DirectoryI _parent;
private boolean _destroyed;
}

```

Implementing FileI

Let us examine how the implementations have changed. The `FileI` methods are still fairly trivial, but there are a few aspects that need discussion.

First, each operation now checks the `_destroyed` member and raises `Ice::ObjectNotExistException` if the member is `true`. This is necessary in order to ensure that the Freeze map is kept in a consistent state. For example, if we allowed the `write` operation to proceed after the file node had been destroyed, then we would have mistakenly added an entry back into the Freeze map for that file. Previous file system implementations ignored this issue because it was relatively harmless, but that is no longer true in this version.

Next, notice that the `write` operation calls `put` on the map after changing the `text` member of its `PersistentFile` object. Although this object is a value in the Freeze map, changing the `text` member has no effect on the persistent state of the map until the value is reinserted into the map, thus overwriting the previous value.

Finally, the constructor now accepts an `Ice::Identity`. This differs from previous implementations in that the identity used to be computed by the constructor. In order to make our servants truly persistent, the identity for a node is computed once when that node is created, and must remain the same for the

lifetime of the node. The `FileI` constructor therefore must not compute a new identity, but rather simply remember the identity that is given to it.

Similarly, the constructor is not responsible for creating a `PersistentFile` object, but rather is given one. This accommodates our two use cases: creating a new file, and restoring an existing file from the map.

```
public
FileI(Ice.Identity id, PersistentFile file,
      DirectoryI parent)
{
    _connection =
        Freeze.Util.createConnection(_communicator, _envName);
    _map =
        new IdentityNodeMap(_connection, _dbName, false);
    _ID = id;
    _file = file;
    _parent = parent;
    _destroyed = false;

    assert(_parent != null);

    // Add the identity of self to the object adapter
    //
    _adapter.add(this, _ID);
}

public synchronized String
name(Ice.Current current)
{
    if (_destroyed)
        throw new Ice.ObjectNotExistException();

    return _file.name;
}

public synchronized void
destroy(Ice.Current current)
    throws PermissionDenied
{
    if (_destroyed)
        throw new Ice.ObjectNotExistException();

    _parent.removeChild(_file.name);
    _map.remove(current.id);
    current.adapter.remove(current.id);
}
```

```

        _map.close();
        _connection.close();
        _destroyed = true;
    }

    public synchronized String[]
    read(Ice.Current current)
    {
        if (_destroyed)
            throw new Ice.ObjectNotExistException();

        return _file.text;
    }

    public synchronized void
    write(String[] text, Ice.Current current)
        throws GenericError
    {
        if (_destroyed)
            throw new Ice.ObjectNotExistException();

        _file.text = text;
        _map.put(_ID, _file);
    }

```

Implementing DirectoryI

The `DirectoryI` implementation requires more substantial changes. We begin our discussion with the `createDirectory` operation.

```

    public synchronized DirectoryPrx
    createDirectory(String name, Ice.Current current)
        throws NameInUse, IllegalName
    {
        if (_destroyed)
            throw new Ice.ObjectNotExistException();

        checkName(name);

        PersistentDirectory persistentDir
            = new PersistentDirectory();
        persistentDir.name = name;
        persistentDir.nodes = new java.util.HashMap();
        DirectoryI dir = new DirectoryI(
            Ice.Util.stringToIdentity(Ice.Util.generateUUID()),
            persistentDir, this);
    }

```



```

    assert(_map.get(dir._ID) == null);
    _map.put(dir._ID, persistentDir);

    DirectoryPrx proxy = DirectoryPrxHelper.uncheckedCast(
        current.adapter.createProxy(dir._ID));

    NodeDesc nd = new NodeDesc();
    nd.name = name;
    nd.type = NodeType.DirType;
    nd.proxy = proxy;
    _dir.nodes.put(name, nd);
    _map.put(_ID, _dir);

    return proxy;
}

```

After validating the node name, the operation creates a `PersistentDirectory`³ object for the child directory, which is passed to the `DirectoryI` constructor along with a unique identity. Next, we store the child's `PersistentDirectory` object in the Freeze map. Finally, we initialize a new `NodeDesc` value and insert it into the parent's node table and then reinsert the parent's `PersistentDirectory` object into the Freeze map.

The implementation of the `createFile` operation has the same structure as `createDirectory`.

```

public synchronized FilePrx
createFile(String name, Ice.Current current)
    throws NameInUse, IllegalName
{
    if (_destroyed)
        throw new Ice.ObjectNotExistException();

    checkName(name);

    PersistentFile persistentFile = new PersistentFile();
    persistentFile.name = name;
    FileI file = new FileI(Ice.Util.stringToIdentity(
        Ice.Util.generateUUID()), persistentFile, this);
    assert(_map.get(file._ID) == null);
    _map.put(file._ID, persistentFile);
}

```

3. Since this Slice class has no operations, the compiler generates a concrete class that an application can instantiate.

```

FilePrx proxy = FilePrxHelper.uncheckedCast(
    current.adapter.createProxy(file._ID));

NodeDesc nd = new NodeDesc();
nd.name = name;
nd.type = NodeType.FileType;
nd.proxy = proxy;
_dir.nodes.put(name, nd);
_map.put(_ID, _dir);

return proxy;
}

```

The next significant change is in the `DirectoryI` constructor. The body of the constructor now instantiates all of its immediate children, which effectively causes all nodes to be instantiated recursively.

For each entry in the directory's node table, the constructor locates the matching entry in the Freeze map. The key type of the Freeze map is `Ice::Identity`, so the constructor obtains the key by invoking `ice_getIdentity` on the child's proxy.

```

public
DirectoryI(Ice.Identity id, PersistentDirectory dir,
           DirectoryI parent)
{
    _connection =
        Freeze.Util.createConnection(_communicator, _envName);
    _map =
        new IdentityNodeMap(_connection, _dbName, false);
    _ID = id;
    _dir = dir;
    _parent = parent;
    _destroyed = false;

    // Add the identity of self to the object adapter
    //
    _adapter.add(this, _ID);

    // Instantiate the child nodes
    //
    java.util.Iterator p = dir.nodes.values().iterator();
    while (p.hasNext()) {
        NodeDesc desc = (NodeDesc)p.next();
        Ice.Identity ident = desc.proxy.ice_getIdentity();
    }
}

```

```

        PersistentNode node = (PersistentNode)_map.get(ident);
        assert(node != null);
        if (desc.type == NodeType.DirType) {
            PersistentDirectory pDir
                = (PersistentDirectory)node;
            DirectoryI d = new DirectoryI(ident, pDir, this);
        } else {
            PersistentFile pFile = (PersistentFile)node;
            FileI f = new FileI(ident, pFile, this);
        }
    }
}

```

If it seems inefficient for the `DirectoryI` constructor to immediately instantiate all of its children, you are right. This clearly will not scale well to large node trees, so why are we doing it?

Previous implementations of the file system service returned transient proxies from `createDirectory` and `createFile`. In other words, if the server was stopped and restarted, any existing child proxies returned by the old instance of the server would no longer work. However, now that we have a persistent store, we should endeavor to ensure that proxies will remain valid across server restarts. There are a couple of implementation techniques that satisfy this requirement:

1. Instantiate all of the servants in advance, as shown in the `DirectoryI` constructor.
2. Use a servant locator.

We chose not to include a servant locator in this example because it complicates the implementation and, as we will see in Section 38.5, a Freeze evictor is ideally suited for this application and a better choice than writing a servant locator.

The last `DirectoryI` method we discuss is `removeChild`, which removes the entry from the node table, and then reinserts the `PersistentDirectory` object into the map to make the change persistent.

```

synchronized void
removeChild(String name)
{
    _dir.nodes.remove(name);
    _map.put(_ID, _dir);
}

```

38.5 The Freeze Evictor

The Freeze evictor combines persistence and scalability features into a single facility that is easily incorporated into Ice applications.

As an implementation of the `ServantLocator` interface (see Section 31.7), the Freeze evictor takes advantage of the fundamental separation between Ice object and servant to activate servants on-demand from persistent storage, and to deactivate them again using customized eviction constraints. Although an application may have thousands of Ice objects in its database, it is not practical to have servants for all of those Ice objects resident in memory simultaneously. The application can conserve resources and gain greater scalability by setting an upper limit on the number of active servants, and letting the Freeze evictor handle the details of servant activation, persistence, and deactivation.

The Freeze evictor maintains a queue of active servants, ordered using a “least recently used” eviction algorithm: if the queue is full, the least recently used servant is evicted to make room for a new servant.

Here is the sequence of events for activating a servant as shown in Figure 38.3. Let us assume that we have configured the evictor with a size of five, that the queue is full, and that a request has arrived for a servant that is not currently active.

1. A client invokes an operation.
2. The object adapter invokes on the evictor to locate the servant.
3. The evictor first checks its active servant queue and fails to find the servant, so it instantiates the servant and restores its persistent state from the database.
4. The evictor adds an item for the servant (servant 1) at the head of the queue.
5. The queue’s length now exceeds the configured maximum, so the evictor removes servant 6 from the queue as soon as it is eligible for eviction. This occurs when there are no outstanding requests pending on servant 6, and its state has been safely stored in the database.

6. The object adapter dispatches the request to the new servant.

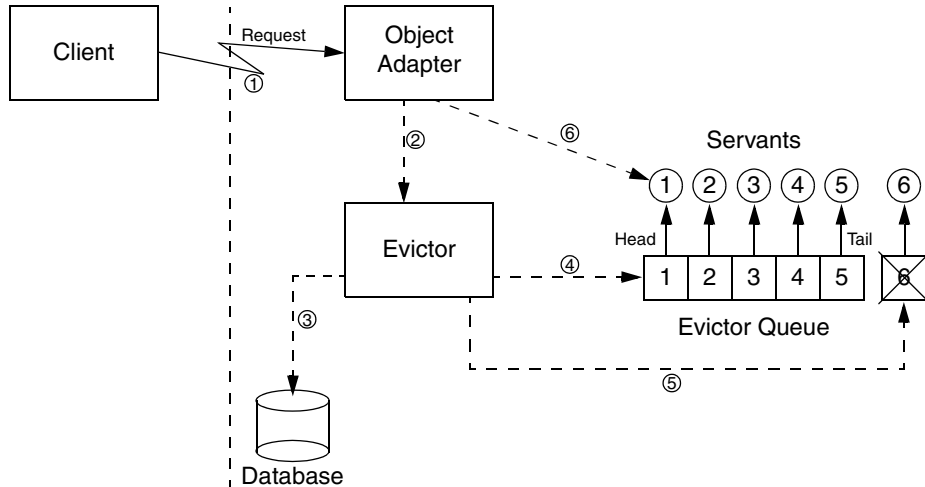

Figure 38.3. An evictor queue after restoring servant 1 and evicting servant 6.

38.5.1 Object Factories

The Freeze evictor is a generic facility in that it manages instances of Object subclasses. Applications are therefore free to use as many object types as necessary, with one requirement: an Ice object factory must be registered for each type.

38.5.2 Servant Association

With the Freeze evictor, each (object identity, facet) pair is associated with its own dedicated persistent object (servant). Such a persistent object cannot serve several identities or facets. Each servant is loaded and saved independently of other servants; in particular, there is no special grouping for the servants that serve the facets of a given Ice object.

Like the ObjectAdapter, the Freeze evictor provides operations named `add`, `addFacet`, `remove` and `removeFacet`. They have the same signature and semantics, except that with the Freeze evictor the mapping and the state of the mapped servants stored on in a database.

38.5.3 Detecting Updates

The Freeze Evictor considers that a servant has been modified when a mutating operation on this servant completes. (See Section 4.10 for more information on mutating operations.) Updates made internally, through calls that are not dispatched through the Freeze Evictor, are not detected and can be lost.

38.5.4 Saving Thread

All persistence activity of a Freeze evictor is handled in a background thread created by the evictor. This thread wakes up periodically and saves the state of all newly-registered, modified, and destroyed servant in the evictor's queue.

For applications that experience bursts of activity, resulting in a large number of modified servants in a short period of time, the evictor's thread can also be configured to begin saving as soon as the number of modified servants reaches a certain threshold.

38.5.5 Synchronization

When the saving thread takes a snapshot of a servant it is about to save, it is necessary to prevent the application from modifying the servant's persistent data members at the same time.

The Freeze evictor and the application need to use a common synchronization to ensure correct behavior. In Java, this common synchronization is the servant itself: the Freeze evictor synchronizes the servant (a Java object) while taking the snapshot. In C++, the servant is required to inherit from the class `IceUtil::AbstractMutex`: the Freeze evictor locks the servant through this interface while taking a snapshot. On the application side, the servant's implementation is required to synchronize all operations that access the servant's data members defined in Slice using the same mechanism.

38.5.6 Keeping Servants in Memory

Sometimes automatically evicting and reloading all servants can be inefficient. You can remove a servant from the evictor's queue by locking this servant "in memory" using the `keep` or `keepFacet` operation on the evictor. `keep` and `keepFacet` are recursive: you need to call `release` or `releaseFacet` for this object the same number of times to put it back in the evictor queue and make it eligible again for eviction.

Servants kept in memory (using `keep` or `keepFacet`) do not consume a slot in the evictor queue. As a result, the maximum number of servants in memory is approximately the number of kept servants plus the evictor size. It can be larger when if you have many evictable objects that are modified but not yet saved.

38.5.7 Indexing a Database

The Freeze evictor supports the use of indices to quickly find persistent objects using the value of a data member as the search criteria. The types allowed for these indices are the same as those allowed for Slice dictionary keys (see Section 4.9.4).

The `slice2freeze` and `slicefreezej` tools can generate an Index class when passed the `--index` option:

- `--index CLASS, TYPE, MEMBER[, case-sensitive | case-insensitive]`

CLASS is the name of the class to be generated. **TYPE** denotes the type of class to be indexed (objects of different classes are not included in this index). **MEMBER** is the name of the data member in **TYPE** to index. When **MEMBER** has type `string`, it is possible to specify whether the index is case-sensitive or not. The default is case-sensitive.

The generated Index class supplies three methods whose definitions are mapped from the following Slice operations:

- `sequence<Ice::Identity> findFirst(member-type index, int firstN)`
Returns up to `firstN` objects of **TYPE** whose **MEMBER** is equal to `index`. This is useful to avoid running out of memory if the potential number of objects matching the criteria can be very large.
- `sequence<Ice::Identity> find(member-type index)`
Returns all the objects of **TYPE** whose **MEMBER** is equal to `index`.
- `int count(<type> index)`
Returns the number of objects of **TYPE** having **MEMBER** equal to `index`.

Indices are associated with a Freeze evictor during evictor creation. See the definition of the `createEvictor` methods for details.

Indexed searches are easy to use and very efficient. However, be aware that an index adds significant write overhead: with Berkeley DB, every update triggers a read from the database to get the old index entry and, if necessary, replace it.

If you add an index to an existing database, by default existing facets are not indexed. If you need to populate a new or empty index using the facets stored in your Freeze evictor, set the property `Freeze.Evictor.env-name.filename.PopulateEmptyIndices` to a value other than 0, which instructs Freeze to iterate over the corresponding facets and create the missing index entries during the call to `createEvictor`. When you use this feature, you must register the object factories for all of the facet types before you invoke `createEvictor`.

38.5.8 Using a Servant Initializer

In some applications it may be necessary to initialize a servant after it is instantiated by the evictor but before an operation is dispatched to it. The Freeze evictor allows an application to specify a servant initializer for this purpose.

To clarify the sequence of events, let us assume that a request has arrived for an Ice facet that is not currently active:

1. The evictor restores a servant for the Ice facet from the database. This involves two steps:
 1. The Ice run time locates and invokes the factory for the Ice facet's type, thereby obtaining a new instance with uninitialized data members.
 2. The data members are populated from the persistent state.
2. The evictor invokes the application's servant initializer (if any) for the servant.
3. The evictor adds the servant to its cache.
4. The evictor dispatches the operation.

The servant initializer is called before the object is inserted into the Freeze evictor internal cache, and *without* holding any internal lock, but in such a way that when the servant initializer is called, the servant is guaranteed to be inserted in the Freeze evictor cache.

There is only one restriction on what a servant initializer can do: it must not make a remote invocation on the facet being initialized. Failing to follow this rule will result in deadlocks.

The file system implementation presented in Section 38.6 on page 1268 demonstrates the use of a servant initializer.

38.5.9 Application Design Considerations

The Freeze evictor creates a snapshot of an Ice facet's state for persistent storage by marshaling the facet, just as if the facet were being sent "over the wire" as a parameter to a remote invocation. Therefore, the Slice definitions for an object type must include the data members comprising the object's persistent state.

For example, we could define a Slice class as follows:

```
class Stateless {
    void calc();
};
```

However, without data members, there will not be any persistent state in the database for objects of this type, and hence there is little value in using the Freeze evictor for this type.

Obviously, Slice object types need to define data members, but there are other design considerations as well. For example, suppose we define a simple application as follows:

```
class Account {
    void withdraw(int amount);
    void deposit(int amount);

    int balance;
};

interface Bank {
    Account* createAccount();
};
```

In this application, we would use the Freeze evictor to manage Account objects that have a data member `balance` representing the persistent state of an account.

From an object-oriented design perspective, there is a glaring problem with these Slice definitions: implementation details (the persistent state) are exposed in the client-server contract. The client cannot directly manipulate the `balance` member because the Bank interface returns Account proxies, not Account instances. However, the presence of the data member may cause unnecessary confusion for client developers.

A better alternative is to clearly separate the persistent state as shown below:

```
interface Account {
    void withdraw(int amount);
    void deposit(int amount);
};
```

```
interface Bank {
    Account* createAccount();
};

class PersistentAccount implements Account {
    int balance;
};
```

Now the Freeze evictor can manage `PersistentAccount` objects, while clients interact with `Account` proxies. (Ideally, `PersistentAccount` would be defined in a different source file and inside a separate module.)

38.6 Using the Freeze Evictor in a File System Server

In this section, we present file system implementations that utilize a Freeze evictor. The implementations are based on the ones discussed in XREF, and in this section we only discuss code that illustrates use of the Freeze evictor.

In general, incorporating a Freeze evictor into your application requires the following steps:

1. Evaluate your existing `Slice` definitions for a suitable persistent object type.
2. If no suitable type is found, you typically define a new derived class which captures your persistent state requirements. Consider placing these definitions in a separate file: they are only used by the server for persistence, and therefore do not need to appear in the “public” definitions required by clients. Also consider placing your persistent types in a separate module to avoid name clashes.
3. Generate code (using `slice2freeze` or `slice2freezej`) for your new definitions.
4. Create an evictor and register it as a servant locator with an object adapter.
5. Create instances of your persistent type and register them with the evictor.

38.6.1 Slice Definitions

Fortunately, it is unnecessary for us to change any of the existing file system `Slice` definitions to incorporate the Freeze evictor. However, we do need to add some definitions to express our persistent state requirements:

```
module Filesystem {
    class PersistentDirectory;

    class PersistentNode implements Node {
        string nodeName;
        PersistentDirectory* parent;
    };

    class PersistentFile extends PersistentNode implements File {
        Lines text;
    };

    class PersistentDirectory extends PersistentNode
        implements Directory {
        void removeNode(string name);

        NodeDict nodes;
    };
};
```

As you can see, we have subclassed all of the node interfaces. Let us examine each one in turn.

The `PersistentNode` class adds two data members: `nodeName`⁴ and `parent`. The file system implementation requires that a child node know its parent node in order to properly implement the `destroy` operation. Previous implementations had a state member of type `DirectoryI`, but that is not workable here. It is no longer possible to pass the parent node to the child node's constructor because the evictor may be instantiating the child node (via a factory), and the parent node will not be known. Even if it were known, another factor to consider is that there is no guarantee that the parent node will be active when the child invokes on it, because the evictor may have evicted it. We solve these issues by storing a proxy to the parent node. If the child node invokes on the parent node via the proxy, the evictor automatically activates the parent node if necessary.

The `PersistentFile` class is very straightforward, simply adding a `text` member representing the contents of the file. Notice that the class extends `PersistentNode`, and therefore inherits the state members declared by the base class.

4. We used `nodeName` instead of `name` because `name` is already used as an operation in the `Node` interface.

Finally, the `PersistentDirectory` class defines the `removeNode` operation, and adds the `nodes` state member representing the immediate children of the directory node. Since a child node contains only a proxy for its `PersistentDirectory` parent, and not a reference to an implementation class, there must be a Slice-defined operation that can be invoked when the child is destroyed.

If we had followed the advice at the beginning of Section 38.5, we would have defined `Node`, `File`, and `Directory` classes in a separate `PersistentFilesystem` module, but in this example we use the existing `Filesystem` module for the sake of simplicity.

38.6.2 Implementing the File System Server in C++

The Server main Program

The server's main program is responsible for creating the evictor and initializing the root directory node. Many of the administrative duties, such as creating and destroying a communicator, are handled by the class `Ice::Application` as described in Section 8.3.1. Our server main program has now become the following:

```
#include <FilesystemI.h>
#include <Freeze/Freeze.h>

using namespace std;
using namespace Filesystem;

class FilesystemApp : virtual public Ice::Application {
public:
    FilesystemApp(const string& envName) :
        _envName(envName) { }

    virtual int run(int, char*[]) {
        // Install object factories
        //
        Ice::ObjectFactoryPtr factory = new NodeFactory;
        communicator()->addObjectFactory(
            factory,
            PersistentFile::ice_staticId());
        communicator()->addObjectFactory(
            factory,
            PersistentDirectory::ice_staticId());

        // Create an object adapter (stored in the NodeI::_adapter
```

```

    // static member
    //
    NodeI::_adapter =
        communicator()->createObjectAdapterWithEndpoints(
            "FreezeFilesystem", "default -p 10000");

    // Create the Freeze evictor (stored in the
    // NodeI::_evictor static member)
    //
    Freeze::ServantInitializerPtr init = new NodeInitializer;
    NodeI::_evictor =
        Freeze::createEvictor(NodeI::_adapter, _envName,
            "evictorfs", init);

    NodeI::_adapter->addServantLocator(NodeI::_evictor, "");

    // Create the root node if it doesn't exist
    //
    Ice::Identity rootId = communicator()->stringToIdentity("R
ootDir");
    if (!NodeI::_evictor->hasObject(rootId)) {
        PersistentDirectoryPtr root = new DirectoryI(rootId);
        root->nodeName = "/";
        NodeI::_evictor->add(root, rootId);
    }

    // Ready to accept requests now
    //
    NodeI::_adapter->activate();

    // Wait until we are done
    //
    communicator()->waitForShutdown();
    if (interrupted()) {
        cerr << appName()
            << ": received signal, shutting down" << endl;
    }

    return 0;
}

private:
    string _envName;
};

int

```

```

main(int argc, char* argv[])
{
    FilesystemApp app("db");
    return app.main(argc, argv);
}

```

Let us examine the changes in detail. First, we are now including `Freeze/Freeze.h` instead of `Ice/Ice.h`. This `Freeze` header file includes all of the other `Freeze` (and `Ice`) header files this source file requires.

Next, we define the class `FilesystemApp` as a subclass of `Ice::Application`, and provide a constructor taking a string argument:

```

FilesystemApp(const string& envName) :
    _envName(envName) { }

```

The string argument represents the name of the database environment, and is saved for later use in `run`.

One of the first tasks `run` performs is installing the `Ice` object factories for `PersistentFile` and `PersistentDirectory`. Although these classes are not exchanged via `Slice` operations, they are marshalled and unmarshalled in exactly the same way when saved to and loaded from the database, therefore factories are required. A single instance of `NodeFactory` is installed for both types.

```

Ice::ObjectFactoryPtr factory = new NodeFactory;
communicator()->addObjectFactory(
    factory,
    PersistentFile::ice_staticId());
communicator()->addObjectFactory(
    factory,
    PersistentDirectory::ice_staticId());

```

After creating the object adapter, the program initializes a `Freeze` evictor by invoking `createEvictor`. The third argument to `createEvictor` is the name of the database file, which by default is created if it does not exist. The new evictor is then added to the object adapter as a servant locator for the default category.

```

Freeze::ServantInitializerPtr init = new NodeInitializer;
NodeI::_evictor =
    Freeze::createEvictor(NodeI::_adapter, _envName,
        "evictorfs", init);
NodeI::_adapter->addServantLocator(NodeI::_evictor, "");

```

Next, the program creates the root directory node if it is not already being managed by the evictor.

```

        Ice::Identity rootId = communicator()->stringToIdentity("R
ootDir");
        if (!NodeI::_evictor->hasObject(rootId)) {
            PersistentDirectoryPtr root = new DirectoryI(rootId);
            root->nodeName = "/";
            NodeI::_evictor->add(root, rootId);
        }

```

Finally, the main function instantiates the `FilesystemApp`, passing `db` as the name of the database environment.

```

int
main(int argc, char* argv[])
{
    FilesystemApp app("db");
    return app.main(argc, argv);
}

```

The Servant Class Definitions

The servant classes must also be changed to incorporate the Freeze evictor. We are maintaining the multiple-inheritance design from XREF, but we have changed the constructors and state members. In particular, each node implementation class has two constructors, one taking no parameters and one taking an `Ice::Identity`. The former is needed by the factory, and the latter is used when the node is first created. To comply with the evictor requirements, `NodeI` implements `IceUtil::AbstractMutex` by deriving from the template class `IceUtil::AbstractMutexI`. The only other change of interest is a new state member in `NodeI` named `_evictor`.

```

namespace Filesystem {
    class NodeI : virtual public PersistentNode,
                  public IceUtil::AbstractMutexI<IceUtil::Mutex> {
    public:
        virtual std::string name(const Ice::Current&) const;
        virtual void destroy(const Ice::Current&);
        static Ice::ObjectAdapterPtr _adapter;
        static Freeze::EvictorPtr _evictor;
    protected:
        NodeI();
        NodeI(const Ice::Identity&);
    public:
        const Ice::Identity _ID;
    };

    class FileI : virtual public PersistentFile,

```

```

        virtual public NodeI {
public:
    virtual Lines read(const Ice::Current&) const;
    virtual void write(const Lines&,
                      const Ice::Current&);

    FileI();
    FileI(const Ice::Identity&);
};

class DirectoryI : virtual public PersistentDirectory,
                  virtual public NodeI {
public:
    virtual NodeDict list(ListMode,
                        const Ice::Current&) const;
    virtual NodeDesc resolve(const std::string&,
                            const Ice::Current&) const;
    virtual DirectoryPrx createDirectory(const std::string&,
                                        const Ice::Current&);
    virtual FilePrx createFile(const std::string&,
                              const Ice::Current&);
    virtual void destroy(const Ice::Current&);
    virtual void removeNode(const std::string&,
                            const Ice::Current&);

    DirectoryI();
    DirectoryI(const Ice::Identity&);
protected:
    void listRecursive(const std::string&,
                     const DirectoryPrx&,
                     NodeDict&) const;
private:
    void checkName(const std::string&) const;
};
}

```

In addition to the node implementation classes, we have also declared implementations of an object factory and a servant initializer:

```

namespace Filesystem {
    class NodeFactory : virtual public Ice::ObjectFactory {
public:
    virtual Ice::ObjectPtr create(const std::string&);
    virtual void destroy();
};

    class NodeInitializer :
        virtual public Freeze::ServantInitializer {

```



```

    public:
        virtual void initialize(const Ice::ObjectAdapterPtr&,
                               const Ice::Identity&,
                               const std::string&,
                               const Ice::ObjectPtr&);
};
}

```

Implementing NodeI

Notice that the NodeI constructor no longer computes a value for the identity. This is necessary in order to make our servants truly persistent. Specifically, the identity for a node is computed once when that node is created, and must remain the same for the lifetime of the node. The NodeI constructor therefore must not compute a new identity, but rather remember the identity that is given to it.

```

string
Filesystem::NodeI::name(const Ice::Current&) const
{
    return nodeName;
}

void
Filesystem::NodeI::destroy(const Ice::Current& current)
{
    if (!parent) {
        Filesystem::PermissionDenied e;
        e.reason = "cannot remove root directory";
        throw e;
    }

    parent->removeNode(nodeName);
    _evictor->remove(_ID);
}

Filesystem::NodeI::NodeI()
{
}

Filesystem::NodeI::NodeI(const Ice::Identity& id)
: _ID(id)
{
}

```

Implementing FileI

The FileI methods are still fairly trivial, because the Freeze evictor is handling persistence for us.

```

Filesystem::Lines
Filesystem::FileI::read(const Ice::Current&) const
{
    IceUtil::Mutex::Lock lock(*this);

    return text;
}

void
Filesystem::FileI::write(const Filesystem::Lines& text,
                        const Ice::Current&)
{
    IceUtil::Mutex::Lock lock(*this);

    this->text = text;
}

Filesystem::FileI::FileI()
{
}

Filesystem::FileI::FileI(const Ice::Identity& id
                        : NodeI(id)
{
}

```

Implementing DirectoryI

The DirectoryI implementation requires more substantial changes. We begin our discussion with the createDirectory operation.

```

Filesystem::DirectoryPrx
Filesystem::DirectoryI::createDirectory(
    const string& name,
    const Ice::Current& current)
{
    IceUtil::Mutex::Lock lock(*this);

    checkName(name);

    Ice::Identity id = current.adapter->getCommunicator()->
        stringToIdentity(IceUtil::generateUUID());
}

```

```

    PersistentDirectoryPtr dir = new DirectoryI(id);
    dir->nodeName = name;
    dir->parent = PersistentDirectoryPrx::uncheckedCast(
        current.adapter->createProxy(current.id));
    DirectoryPrx proxy = _evictor->add(dir, id);

    NodeDesc nd;
    nd.name = name;
    nd.type = DirType;
    nd.proxy = proxy;
    nodes[name] = nd;

    return proxy;
}

```

After validating the node name, the operation obtains a unique identity for the child directory, instantiates the servant, and registers it with the Freeze evictor. Finally, the operation creates a proxy for the child and adds the child to its node table.

The implementation of the `createFile` operation has the same structure as `createDirectory`.

```

Filesystem::FilePrx
Filesystem::DirectoryI::createFile(
    const string& name,
    const Ice::Current& current)
{
    IceUtil::Mutex::Lock lock(*this);

    checkName(name);

    Ice::Identity id = current.adapter->getCommunicator()->
        stringToIdentity(IceUtil::generateUUID());
    PersistentFilePtr file = new FileI(id);
    file->nodeName = name;
    file->parent = PersistentDirectoryPrx::uncheckedCast(
        current.adapter->createProxy(current.id));
    FilePrx proxy = _evictor->add(file, id);

    NodeDesc nd;
    nd.name = name;
    nd.type = FileType;
}

```

```

        nd.proxy = proxy;

        return proxy;
    }

```

Implementing NodeFactory

We use a single factory implementation for creating two types of Ice objects: `PersistentFile` and `PersistentDirectory`. These are the only two types that the Freeze evictor will be restoring from its database.

```

Ice::ObjectPtr
Filesystem::NodeFactory::create(const string& type)
{
    if (type == "::Filesystem::PersistentFile")
        return new FileI;
    else if (type == "::Filesystem::PersistentDirectory")
        return new DirectoryI;
    else {
        assert(false);
        return 0;
    }
}

void
Filesystem::NodeFactory::destroy()
{
}

```

Implementing NodeInitializer

`NodeInitializer` is a trivial implementation of the `Freeze::ServantInitializer` interface whose only responsibility is setting the `_ID` member of the node implementation. The evictor invokes the `initialize` operation after the evictor has created a servant and restored its persistent state from the database, but before any operations are dispatched to it.

```

void
Filesystem::NodeInitializer::initialize(
    const Ice::ObjectAdapterPtr&,
    const Ice::Identity& id,
    const Ice::ObjectPtr& obj)
{
}

```

```
NodeIPtr node = NodeIPtr::dynamicCast(obj);
assert(node);
const_cast<Ice::Identity&>(node->_ID) = id;
}
```

38.6.3 Implementing the File System Server in Java

The Server main Program

The server's main program is responsible for creating the evictor and initializing the root directory node. Many of the administrative duties, such as creating and destroying a communicator, are handled by the class `Ice.Application` as described in Section 12.3.1. Our server main program has now become the following:

```
import Filesystem.*;

public class Server extends Ice.Application {
    public
    Server(String envName)
    {
        _envName = envName;
    }

    public int
    run(String[] args)
    {
        // Install object factories
        //
        Ice.ObjectFactory factory = new NodeFactory();
        communicator().addObjectFactory(
            factory,
            PersistentFile.ice_staticId());
        communicator().addObjectFactory(
            factory,
            PersistentDirectory.ice_staticId());

        // Create an object adapter (stored in the _adapter
        // static member)
        //
        Ice.ObjectAdapter adapter =
            communicator().createObjectAdapterWithEndpoints(
                "FreezeFilesystem", "default -p 10000");
        DirectoryI._adapter = adapter;
    }
}
```

```
FileI._adapter = adapter;

// Create the Freeze evictor (stored in the _evictor
// static member)
//
Freeze.ServantInitializer init = new NodeInitializer();
Freeze.Evictor evictor =
    Freeze.Util.createEvictor(adapter, _envName,
                              "evictorfs", init, null,
                              true);
DirectoryI._evictor = evictor;
FileI._evictor = evictor;

adapter.addServantLocator(evictor, "");

// Create the root node if it doesn't exist
//
Ice.Identity rootId =
    Ice.Util.stringToIdentity("RootDir");
if(!evictor.hasObject(rootId))
{
    PersistentDirectory root = new DirectoryI(rootId);
    root.nodeName = "/";
    root.nodes = new java.util.HashMap();
    evictor.add(root, rootId);
}

// Ready to accept requests now
//
adapter.activate();

// Wait until we are done
//
communicator().waitForShutdown();

return 0;
}

public static void
main(String[] args)
{
    Server app = new Server("db");
    app.main("Server", args);
    System.exit(0);
}
```

```
    }  
  
    private String _envName;  
}
```

Let us examine the changes in detail. First, we define the class `Server` as a subclass of `Ice.Application`, and provide a constructor taking a string argument:

```
public  
Server(String envName)  
{  
    _envName = envName;  
}
```

The string argument represents the name of the database environment, and is saved for later use in `run`.

One of the first tasks `run` performs is installing the Ice object factories for `PersistentFile` and `PersistentDirectory`. Although these classes are not exchanged via Slice operations, they are marshalled and unmarshalled in exactly the same way when saved to and loaded from the database, therefore factories are required. A single instance of `NodeFactory` is installed for both types.

```
Ice.ObjectFactory factory = new NodeFactory();  
communicator().addObjectFactory(  
    factory,  
    PersistentFile.ice_staticId());  
communicator().addObjectFactory(  
    factory,  
    PersistentDirectory.ice_staticId());
```

After creating the object adapter, the program initializes a Freeze evictor by invoking `createEvictor`. The third argument to `createEvictor` is the name of the database, the fourth is the servant initializer, then the `null` argument indicates no indices are in use, and the `true` argument requests that the database be created if it does not exist. The evictor is then added to the object adapter as a servant locator for the default category.

```
Freeze.ServantInitializer init = new NodeInitializer();  
Freeze.Evictor evictor =  
    Freeze.Util.createEvictor(adapter, _envName,  
                             "evictorfs", init, null,  
                             true);
```

```

DirectoryI._evictor = evictor;
FileI._evictor = evictor;

adapter.addServantLocator(evictor, "");

```

Next, the program creates the root directory node if it is not already being managed by the evictor.

```

Ice.Identity rootId =
    Ice.Util.stringToIdentity("RootDir");
if(!evictor.hasObject(rootId))
{
    PersistentDirectory root = new DirectoryI(rootId);
    root.nodeName = "/";
    root.nodes = new java.util.HashMap();
    evictor.add(root, rootId);
}

```

Finally, the main function instantiates the `Server` class, passing `db` as the name of the database environment.

```

public static void
main(String[] args)
{
    Server app = new Server("db");
    app.main("Server", args);
    System.exit(0);
}

```

The Servant Class Definitions

The servant classes must also be changed to incorporate the Freeze evictor. We are maintaining the design from XREF, but we have changed the constructors and state members. In particular, each node implementation class has two constructors, one taking no parameters and one taking an `Ice::Identity`. The former is needed by the factory, and the latter is used when the node is first created. The only other change of interest is the new state member `_evictor`.

The `FileI` class has a new static member of type `IdentityNodeMap`, which avoids the need to duplicate this reference in each node. The class has a new instance member of type `PersistentFile`, representing the persistent state of this file. Finally, we have changed the constructor to accept an `Ice.Identity` and a `PersistentFile`.

```
package Filesystem;

public class FileI extends PersistentFile
{
    public
    FileI()
    {
        // ...
    }

    public
    FileI(Ice.Identity id)
    {
        // ...
    }

    // ... Ice operations ...

    public static Ice.ObjectAdapter _adapter;
    public static Freeze.Evictor _evictor;
    public Ice.Identity _ID;
}
```

The DirectoryI class has undergone a similar transformation.

```
package Filesystem;

public final class DirectoryI extends PersistentDirectory
{
    public
    DirectoryI()
    {
        // ...
    }

    public
    DirectoryI(Ice.Identity id)
    {
        // ...
    }

    // ... Ice operations ...
}
```

```
    public static Ice.ObjectAdapter _adapter;
    public static Freeze.Evictor _evictor;
    public Ice.Identity _ID;
}
```

Notice that the constructors no longer compute a value for the identity. This is necessary in order to make our servants truly persistent. Specifically, the identity for a node is computed once when that node is created, and must remain the same for the lifetime of the node. A constructor therefore must not compute a new identity, but rather remember the identity given to it.

Implementing FileI

The FileI methods are still fairly trivial, because the Freeze evictor is handling persistence for us.

```
public
FileI()
{
}

public
FileI(Ice.Identity id)
{
    _ID = id;
}

public String
name(Ice.Current current)
{
    return nodeName;
}

public void
destroy(Ice.Current current)
    throws PermissionDenied
{
    parent.removeNode(nodeName);
    _evictor.remove(current.id);
}

public synchronized String[]
read(Ice.Current current)
{
    return text;
}
```

```
public synchronized void
write(String[] text, Ice.Current current)
    throws GenericError
{
    this.text = text;
}
```

Implementing DirectoryI

The `DirectoryI` implementation requires more substantial changes. We begin our discussion with the `createDirectory` operation.

```
public synchronized DirectoryPrx
createDirectory(String name, Ice.Current current)
    throws NameInUse, IllegalName
{
    checkName(name);

    Ice.Identity id =
        Ice.Util.stringToIdentity(Ice.Util.generateUUID());
    PersistentDirectory dir = new DirectoryI(id);
    dir.nodeName = name;
    dir.parent = PersistentDirectoryPrxHelper.uncheckedCast(
        current.adapter.createProxy(current.id));
    dir.nodes = new java.util.HashMap();
    DirectoryPrx proxy = _evictor.add(dir, id);

    NodeDesc nd = new NodeDesc();
    nd.name = name;
    nd.type = NodeType.DirType;
    nd.proxy = proxy;
    nodes.put(name, nd);

    return proxy;
}
```

After validating the node name, the operation obtains a unique identity for the child directory, instantiates the servant, and registers it with the Freeze evictor. Finally, the operation creates a proxy for the child and adds the child to its node table.

The implementation of the `createFile` operation has the same structure as `createDirectory`.

```

public synchronized FilePrx
createFile(String name, Ice.Current current)
    throws NameInUse, IllegalName
{
    checkName(name);

    Ice.Identity id =
        Ice.Util.stringToIdentity(Ice.Util.generateUUID());
    PersistentFile file = new FileI(id);
    file.nodeName = name;
    file.parent = PersistentDirectoryPrxHelper.uncheckedCast(
        current.adapter.createProxy(current.id));
    FilePrx proxy = _evictor.add(file, id);

    NodeDesc nd = new NodeDesc();
    nd.name = name;
    nd.type = NodeType.FileType;
    nd.proxy = proxy;
    nodes.put(name, nd);

    return proxy;
}

```

Implementing NodeFactory

We use a single factory implementation for creating two types of Ice objects: `PersistentFile` and `PersistentDirectory`. These are the only two types that the Freeze evictor will be restoring from its database.

```

package Filesystem;

public class NodeFactory extends Ice.LocalObjectImpl
    implements Ice.ObjectFactory
{
    public Ice.Object
    create(String type)
    {
        if (type.equals("::Filesystem::PersistentFile"))
            return new FileI();
        else if (type.equals("::Filesystem::PersistentDirectory"))
            return new DirectoryI();
        else {
            assert(false);
            return null;
        }
    }
}

```

```
    public void
    destroy()
    {
    }
}
```

Implementing `NodeInitializer`

`NodeInitializer` is a trivial implementation of the `Freeze::ServantInitializer` interface whose only responsibility is setting the `_ID` member of the node implementation. The evictor invokes the `initialize` operation after the evictor has created a servant and restored its persistent state from the database, but before any operations are dispatched to it.

```
package Filesystem;

public class NodeInitializer extends Ice.LocalObjectImpl
    implements Freeze.ServantInitializer {
    public void
    initialize(Ice.ObjectAdapter adapter, Ice.Identity id,
              String facet, Ice.Object obj)
    {
        if (obj instanceof FileI)
            ((FileI)obj)._ID = id;
        else
            ((DirectoryI)obj)._ID = id;
    }
}
```

38.7 Summary

Freeze is a collection of services that simplify the use of persistence in Ice applications. The Freeze map is an associative container mapping any Slice key and value types, providing a convenient and familiar interface to a persistent map. The Freeze evictor is an especially powerful facility for supporting persistent Ice objects in a highly-scalable implementation.

Chapter 39

FreezeScript

39.1 Chapter Overview

This chapter describes the FreezeScript tools for migrating and inspecting the databases created by Freeze maps and evictors. The discussion of database migration begins in Section 39.3 and continues through Section 39.5. Database inspection is presented in Section 39.6 and Section 39.7. Finally, Section 39.8 describes the expression language supported by the FreezeScript tools.

39.2 Introduction

As described in Chapter 38, Freeze supplies a valuable set of services for simplifying the use of persistence in Ice applications. However, while Freeze makes it easy for an application to manage its persistent state, there are additional administrative responsibilities that must also be addressed:

- Migration

As an application evolves, it is not unusual for the types describing its persistent state to evolve as well. When these changes occur, a great deal of time can be saved if existing databases can be migrated to the new format while preserving as much information as possible.

- Inspection

The ability to examine a database can be helpful during every stage of the application's lifecycle, from development to deployment.

FreezeScript provides tools for performing both of these activities on Freeze map and evictor databases. These databases have a well-defined structure because the key and value of each record consist of the marshaled bytes of their respective Slice types. This design allows the FreezeScript tools to operate on any Freeze database using only the Slice definitions for the database types.

39.3 Database Migration

The FreezeScript tool **transformdb** migrates a database created by a Freeze map or evictor. It accomplishes this by comparing the “old” Slice definitions (i.e., the ones that describe the current contents of the database) with the “new” Slice definitions, and making whatever modifications are necessary to ensure that the transformed database is compatible with the new definitions.

This would be difficult to achieve by writing a custom transformation program because that program would require static knowledge of the old and new types, which frequently define many of the same symbols and would therefore prevent the program from being loaded. The **transformdb** tool avoids this issue using an interpretive approach: the Slice definitions are parsed and used to drive the extraction of the database records.

The tool supports two modes of operation:

1. automatic migration, in which the database is migrated in a single step using only the default set of transformations, and
2. custom migration, in which you supply a script to augment or override the default transformations.

39.3.1 Default Transformations

The default transformations performed by **transformdb** preserve as much information as possible. However, there are practical limits to the tool's capabilities, since the only information it has is obtained by performing a comparison of the Slice definitions.

For example, suppose our old definition for a structure is the following:

```
struct AStruct {
    int i;
};
```

We want to migrate instances of this struct to the following revised definition:

```
struct AStruct {
    int j;
};
```

As the developers, we know that the `int` member has been renamed from `i` to `j`, but to **transformdb** it appears that member `i` was removed and member `j` was added. The default transformation results in exactly that behavior: the value of `i` is lost, and `j` is initialized to a default value. If we need to preserve the value of `i` and transfer it to `j`, then we need to use custom migration (see Section 39.3.5).

The changes that occur as a type system evolves can be grouped into three categories:

- Data members

The data members of class and structure types are added, removed, or renamed. As discussed above, the default transformations initialize new and renamed data members to default values (see Section 39.3.3).

- Type names

Types are added, removed, or renamed. New types do not pose a problem for database migration when used to define a new data member; the member is initialized with default values as usual. On the other hand, if the new type replaces the type of an existing data member, then type compatibility becomes a factor (see the following item).

Removed types generally do not cause problems either, because any uses of that type must have been removed from the new Slice definitions (e.g., by removing data members of that type). There is one case, however, where removed types become an issue, and that is for polymorphic classes (see Section 39.5.5).

Renamed types are a concern, just like renamed data members, because of the potential for losing information during migration. This is another situation for which custom migration is recommended.

- Type content

Examples of changes of type content include the key type of a dictionary, the element type of a sequence, or the type of a data member. If the old and new types are not compatible (as defined in Section 39.3.2), then the default trans-

formation emits a warning, discards the current value, and reinitializes the value as described in Section 39.3.3.

39.3.2 Type Compatibility

Changes in the type of a value are restricted to certain sets of compatible changes. This section describes the type changes supported by the default transformations. All incompatible type changes result in a warning indicating that the current value is being discarded and a default value for the new type assigned in its place. Additional flexibility is provided by custom migration, as described in Section 39.3.5.

Boolean

A value of type `bool` can be transformed to and from `string`. The legal string values for a `bool` value are `"true"` and `"false"`.

Integer

The integer types `byte`, `short`, `int`, and `long` can be transformed into each other, but only if the current value is within range of the new type. These integer types can also be transformed into `string`.

Floating Point

The floating-point types `float` and `double` can be transformed into each other, as well as to `string`. No attempt is made to detect a loss of precision during transformation.

String

A `string` value can be transformed into any of the primitive types, as well as into enumeration and proxy types, but only if the value is a legal string representation of the new type. For example, the string value `"Pear"` can be transformed into the enumeration `Fruit`, but only if `Pear` is an enumerator of `Fruit`.

Enum

An enumeration can be transformed into an enumeration with the same type id, or into a string. Transformation between enumerations is performed symbolically. For example, consider our old type below:

```
enum Fruit { Apple, Orange, Pear };
```

Suppose the enumerator `Pear` is being transformed into the following new type:

```
enum Fruit { Apple, Pear };
```

The transformed value in the new enumeration is also `Pear`, despite the fact that `Pear` has changed positions in the new type. However, if the old value had been `Orange`, then the default transformation emits a warning because that enumerator no longer exists, and initializes the new value to `Apple` (the default value).

If an enumerator has been renamed, then custom migration is required to convert enumerators from the old name to the new one.

Sequence

A sequence can be transformed into another sequence type, even if the new sequence type does not have the same type id as the old type, but only if the element types are compatible. For example, `sequence<short>` can be transformed into `sequence<int>`, regardless of the names given to the sequence types.

Dictionary

A dictionary can be transformed into another dictionary type, even if the new dictionary type does not have the same type id as the old type, but only if the key and value types are compatible. For example, `dictionary<int, string>` can be transformed into `dictionary<long, string>`, regardless of the names given to the dictionary types.

Caution is required when changing the key type of a dictionary, because the default transformation of keys could result in duplication. For example, if the key type changes from `int` to `short`, any `int` value outside the range of `short` results in the key being initialized to a default value (namely zero). If zero is already used as a key in the dictionary, or another out-of-range key is encountered, then a duplication occurs. The transformation handles key duplication by removing the duplicate element from the transformed dictionary. (Custom migration can be useful in these situations if the default behavior is not acceptable.)

Structure

A `struct` type can only be transformed into another `struct` type with the same type id. Data members are transformed as appropriate for their types.

Proxy

A proxy value can be transformed into another proxy type, or into `string`. Transformation into another proxy type is done with the same semantics as in a

language mapping: if the new type does not match the old type, then the new type must be a base type of the old type (that is, the proxy is widened).

Class

A `class` type can only be transformed into another `class` type with the same type id. A data member of a `class` type is allowed to be widened to a base type. Data members are transformed as appropriate for their types. See Section 39.5.5 for more information on transforming classes.

39.3.3 Default Values

Data types are initialized with default values, as shown in Table 39.1.

Table 39.1. Default values for Slice types.

Type	Default Value
Boolean	<code>false</code>
Numeric	Zero (0)
String	Empty string
Enumeration	The first enumerator
Sequence	Empty sequence
Dictionary	Empty dictionary
Struct	Data members are initialized recursively
Proxy	Nil
Class	Nil

39.3.4 Running an Automatic Transformation

In order to use automatic transformation, we need to supply the following information to `transformdb`:

- The old and new Slice definitions
- The old and new types for the database key and value
- The database environment directory, the database filename, and the name of a new database environment directory to hold the transformed database

Here is an example of a `transformdb` command:

```
$ transformdb --old old/MyApp.ice --new new/MyApp.ice \  
  --key int,string --value ::Employee db emp.db newdb
```

Briefly, the `--old` and `--new` options specify the old and new Slice definitions, respectively. These options can be specified as many times as necessary in order to load all of the relevant definitions. The `--key` option indicates that the database key is evolving from `int` to `string`. The `--value` option specifies that `::Employee` is used as the database value type in both old and new type definitions, and therefore only needs to be specified once. Finally, we provide the pathname of the database environment directory (`db`), the filename of the database (`emp.db`), and the pathname of the database environment directory for the transformed database (`newdb`).

See Section 39.5 for more information on using `transformdb`.

39.3.5 Custom Migration

Custom migration is useful when your types have changed in ways that make automatic migration difficult or impossible. It is also convenient to use custom migration when you have complex initialization requirements for new types or new data members, because custom migration enables you to perform many of the same tasks that would otherwise require you to write a throwaway program.

Custom migration operates in conjunction with automatic migration, allowing you to inject your own transformation rules at well-defined intercept points in the automatic migration process. These rules are called *transformation descriptors*, and are written in XML.

A Simple Example

We can use a simple example to demonstrate the utility of custom migration. Suppose our application uses a Freeze map whose type is `string` and whose value is an enumeration, defined as follows:

```
enum BigThree { Ford, Chrysler, GeneralMotors };
```

We now wish to rename the enumerator `Chrysler`, as shown in our new definition:

```
enum BigThree { Ford, DaimlerChrysler, GeneralMotors };
```

As explained in Section 39.3.2, the default transformation results in all occurrences of the `Chrysler` enumerator being transformed into `Ford`, because

Chrysler no longer exists in the new definition and therefore the default value Ford is used instead.

To remedy this situation, we use the following transformation descriptors:

```
<transformdb>
  <database key="string" value="::BigThree">
    <record>
      <if test="oldvalue == ::Old::Chrysler">
        <set target="newvalue"
          value="::New::DaimlerChrysler"/>
      </if>
    </record>
  </database>
</transformdb>
```

When executed, these descriptors convert occurrences of Chrysler in the old type system into DaimlerChrysler in the transformed database's new type system. Transformation descriptors are described in detail in Section 39.4.

39.4 Transformation Descriptors

This section describes the XML elements comprising the FreezeScript transformation descriptors.

39.4.1 Overview

A transformation descriptor file has a well-defined structure. The top-level descriptor in the file is `<transformdb>`. A `<database>` descriptor must be present within `<transformdb>` to define the key and value types used by the database. Inside `<database>`, the `<record>` descriptor triggers the transformation process. See Section 39.3.5 for an example that demonstrates the structure of a minimal descriptor file.

During transformation, type-specific actions are supported by the `<transform>` and `<init>` descriptors, both of which are children of `<transformdb>`. One `<transform>` descriptor and one `<init>` descriptor may be defined for each type in the new Slice definitions. Each time **transformdb** creates a new instance of a type, it executes the `<init>` descriptor for that type, if one is defined. Similarly, each time **transformdb** transforms an instance of an old type into a new type, the `<transform>` descriptor for the new type is executed.

The `<database>`, `<record>`, `<transform>`, and `<init>` descriptors may contain general-purpose action descriptors such as `<if>`, `<set>`, and `<echo>`. These actions resemble statements in programming languages like C++ and Java, in that they are executed in the order of definition and their effects are cumulative. Actions make use of the expression language described in Section 39.8.

39.4.2 Flow of Execution

The transformation descriptors are executed as described below.

- `<database>` is executed first. Each child descriptor of `<database>` is executed in the order of definition. If a `<record>` descriptor is present, database transformation occurs at that point. Any child descriptors of `<database>` that follow `<record>` are not executed until transformation completes.
- During transformation of each record, **transformdb** creates instances of the new key and value types, which includes the execution of the `<init>` descriptors for those types. Next, the old key and value are transformed into the new key and value, in the following manner:
 1. Locate the `<transform>` descriptor for the type.
 2. If no descriptor is found, or the descriptor exists and it does not preclude default transformation, then transform the data as described in Section 39.3.1.
 3. If the `<transform>` descriptor exists, execute it.
 4. Finally, execute the child descriptors of `<record>`.

See Section 39.4.4 for detailed information on the transformation descriptors.

39.4.3 Scopes

The `<database>` descriptor creates a global scope, allowing child descriptors of `<database>` to define symbols that are accessible in any descriptor¹. Furthermore, certain other descriptors create local scopes that exist only for the duration of the descriptor's execution. For example, the `<transform>` descriptor creates

1. In order for a global symbol to be available to a `<transform>` or `<init>` descriptor, the symbol must be defined before the `<record>` descriptor is executed.

a local scope and defines the symbols `old` and `new` to represent a value in its old and new forms. Child descriptors of `<transform>` can also define new symbols in the local scope, as long as those symbols do not clash with an existing symbol in that scope. It is legal to add a new symbol with the same name as a symbol in an outer scope, but the outer symbol will not be accessible during the descriptor's execution.

The global scope is useful in many situations. For example, suppose you want to track the number of times a certain value was encountered during transformation. This can be accomplished as shown below:

```
<transformdb>
  <database key="string" value="::Ice::Identity">
    <define name="categoryCount" type="int" value="0"/>
    <record/>
    <echo message="categoryCount = " value="categoryCount"/>
  </database>
  <transform type="::Ice::Identity">
    <if test="new.category == 'Accounting'">
      <set target="categoryCount" value="categoryCount + 1"/>
    </if>
  </transform>
</transformdb>
```

In this example, the `<define>` descriptor introduces the symbol `categoryCount` into the global scope, defining it as type `int` with an initial value of zero. Next, the `<record>` descriptor causes transformation to proceed. Each occurrence of the type `Ice::Identity` causes its `<transform>` descriptor to be executed, which examines the `category` member and increases `categoryCount` if necessary. Finally, after transformation completes, the `<echo>` descriptor displays the final value of `categoryCount`.

To reinforce the relationships between descriptors and scopes, consider the diagram in Figure 39.1. Several descriptors are shown, including the symbols they define in their local scopes. In this example, the `<iterate>` descriptor has a dictionary target and therefore the default symbol for the element value, `value`, hides the symbol of the same name in the parent `<init>` descriptor's scope². In

2. This situation can be avoided by assigning a different symbol name to the element value.

addition to symbols in the `<iterate>` scope, child descriptors of `<iterate>` can also refer to symbols from the `<init>` and `<database>` scopes.

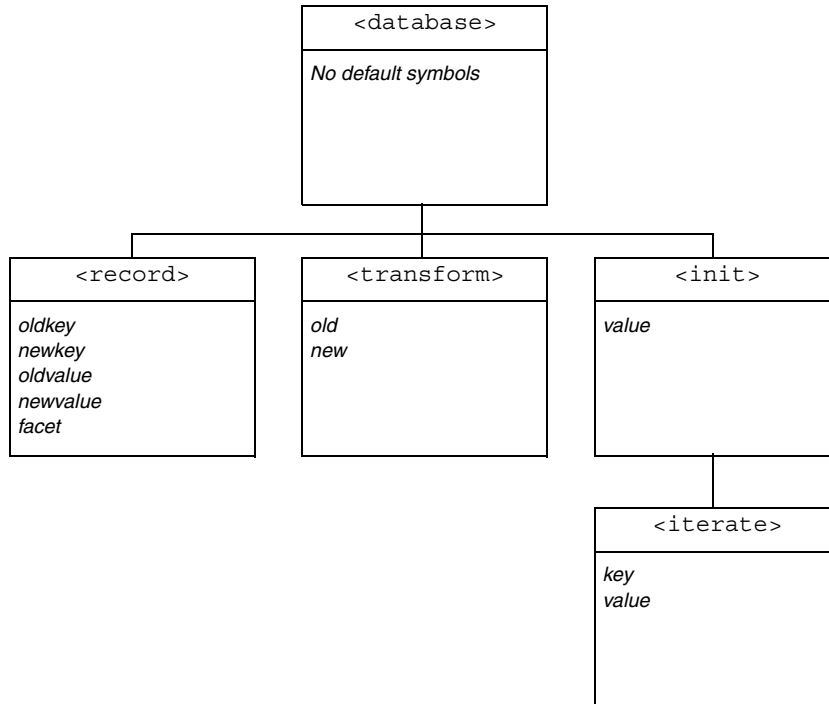

Figure 39.1. Relationship between descriptors and scopes.

39.4.4 Descriptor Reference

`<transformdb>`

The top-level descriptor in a descriptor file. It requires one child descriptor, `<database>`, and supports any number of `<transform>` and `<init>` descriptors. This descriptor has no attributes.

`<database>`

The attributes of this descriptor define the old and new key and value types for the database to be transformed. It supports any number of child descriptors, but at

most one `<record>` descriptor. The `<database>` descriptor also creates a global scope for user-defined symbols (see Section 39.4.3).

The attributes supported by the `<database>` descriptor are described in Table 39.2.

Table 39.2. Attributes for `<database>` descriptor.

Name	Description
key	Specifies the Slice types of the old and new keys. If the types are the same, only one needs to be specified. Otherwise, the types are separated by a comma.
value	Specifies the Slice types of the old and new values. If the types are the same, only one needs to be specified. Otherwise, the types are separated by a comma.

As an example, consider the following `<database>` descriptor. In this case, the Freeze map to be transformed currently has key type `int` and value type `::Employee`, and is migrating to a key type of `string`:

```
<database key="int,string" value="::Employee">
```

<record>

Commences the transformation. Child descriptors are executed for each record in the database, providing the user with an opportunity to examine the record's old key and value, and optionally modify the new key and value. Default transformations, as well as `<transform>` and `<init>` descriptors, are executed before the child descriptors. The `<record>` descriptor introduces the following symbols into a local scope: `oldkey`, `newkey`, `oldvalue`, `newvalue`, `facet`. These symbols are accessible to child descriptors, but not to `<transform>` or `<init>` descriptors. The `oldkey` and `oldvalue` symbols are read-only. The `facet` symbol is a string indicating the facet name of the object in the current record, and is only relevant for Freeze evictor databases.

Use caution when modifying database keys to ensure that duplicate keys do not occur. If a duplicate database key is encountered, transformation fails immediately.

Note that database transformation only occurs if a `<record>` descriptor is present.

<transform>

Customizes the transformation for all instances of a type in the new Slice definitions. The children of this descriptor are executed after the optional default transformation has been performed, as described in Section 39.3.1. Only one `<transform>` descriptor can be specified for a type, but a `<transform>` descriptor is not required for every type. The symbols `old` and `new` are introduced into a local scope and represent the old and new values, respectively. The `old` symbol is read-only. The attributes supported by this descriptor are described in Table 39.3.

Table 39.3. Attributes for `<transform>` descriptor.

Name	Description
<code>type</code>	Specifies the type id in the new Slice definitions.
<code>default</code>	If <code>false</code> , no default transformation is performed on values of this type. If not specified, the default value is <code>true</code> .
<code>base</code>	This attribute determines whether <code><transform></code> descriptors of base class types are executed. If <code>true</code> , the <code><transform></code> descriptor of the immediate base class is invoked. If no descriptor is found for the immediate base class, the class hierarchy is searched until a descriptor is found. The execution of any base class descriptors occurs after execution of this descriptor's children. If not specified, the default value is <code>true</code> .
<code>rename</code>	Indicates that a type in the old Slice definitions has been renamed to the new type identified by the <code>type</code> attribute. The value of this attribute is the type id of the old Slice definition. Specifying this attribute relaxes the strict compatibility rules defined in Section 39.3.2 for <code>enum</code> , <code>struct</code> and <code>class</code> types.

Below is an example of a `<transform>` descriptor that initializes a new data member:

```
<transform type="::Product">
  <set target="new.salePrice"
    value="old.listPrice * old.discount"/>
</transform>
```

For class types, **transformdb** first attempts to locate a `<transform>` descriptor for the object's most-derived type. If no descriptor is found, **trans-**

formdb proceeds up the class hierarchy in an attempt to find a descriptor. The base object type, `Object`, is the root of every class hierarchy and is included in the search for descriptors. It is therefore possible to define a `<transform>` descriptor for type `Object`, which will be invoked for every class instance.

Note that `<transform>` descriptors are executed recursively. For example, consider the following Slice definitions:

```
struct Inner {
    int sum;
};
struct Outer {
    Inner i;
};
```

When **transformdb** is performing the default transformation on a value of type `Outer`, it recursively performs the default transformation on the `Inner` member, then executes the `<transform>` descriptor for `Inner`, and finally executes the `<transform>` descriptor for `Outer`. However, if default transformation is disabled for `Outer`, then no transformation is performed on the `Inner` member and therefore the `<transform>` descriptor for `Inner` is not executed.

`<init>`

Defines custom initialization rules for all instances of a type in the new Slice definitions. Child descriptors are executed each time the type is instantiated. The typical use case for this descriptor is for types that have been introduced in the new Slice definitions and whose instances require default values different than what **transformdb** supplies. The symbol `value` is introduced into a local scope to represent the instance. The attributes supported by this descriptor are described in Table 39.4.

Table 39.4. Attributes for `<init>` descriptor.

Name	Description
<code>type</code>	Specifies the type id of the new Slice definition.

Here is a simple example of an `<init>` descriptor:

```
<init type="::Player">
  <set target="value.currency" value="100"/>
</init>
```

Note that, like `<transform>`, `<init>` descriptors are executed recursively. For example, if an `<init>` descriptor is defined for a struct type, the `<init>` descriptors of the struct's members are executed before the struct's descriptor.

<iterate>

Iterates over a dictionary or sequence, executing child descriptors for each element. The symbol names selected to represent the element information may conflict with existing symbols in the enclosing scope, in which case those outer symbols are not accessible to child descriptors. The attributes supported by this descriptor are described in Table 39.5.

Table 39.5. Attributes for `<iterate>` descriptor.

Name	Description
target	The sequence or dictionary.
index	The symbol name used for the sequence index. If not specified, the default symbol is <code>i</code> .
element	The symbol name used for the sequence element. If not specified, the default symbol is <code>elem</code> .
key	The symbol name used for the dictionary key. If not specified, the default symbol is <code>key</code> .
value	The symbol name used for the dictionary value. If not specified, the default symbol is <code>value</code> .

Shown below is an example of an `<iterate>` descriptor that sets the new data member `reviewSalary` to `true` if the employee's salary is greater than \$3000.

```
<iterate target="new.employeeMap" key="id" value="emp">
  <if test="emp.salary > 3000">
    <set target="emp.reviewSalary" value="true"/>
  </if>
</iterate>
```

<if>

Conditionally executes child descriptors. The attributes supported by this descriptor are described in Table 39.6.

Table 39.6. Attributes for `<if>` descriptor.

Name	Description
<code>test</code>	A boolean expression.

See Section 39.8 for more information on the descriptor expression language.

<set>

Modifies a value. The `value` and `type` attributes are mutually exclusive. If `target` denotes a dictionary element, that element must already exist (i.e., `<set>` cannot be used to add an element to a dictionary). The attributes supported by this descriptor are described in Table 39.7.

Table 39.7. Attributes for `<set>` descriptor.

Name	Description
<code>target</code>	An expression that must select a modifiable value.
<code>value</code>	An expression that must evaluate to a value compatible with the target's type.
<code>type</code>	If specified, set the target to be an instance of the given <code>Slice</code> class. The value is a type id from the new <code>Slice</code> definitions. The class must be compatible with the target's type.
<code>length</code>	An integer expression representing the desired new length of a sequence. If the new length is less than the current size of the sequence, elements are removed from the end of the sequence. If the new length is greater than the current size, new elements are added to the end of the sequence. If <code>value</code> or <code>type</code> is also specified, it is used to initialize each new element.
<code>convert</code>	If <code>true</code> , additional type conversions are supported: between integer and floating point, and between integer and enumeration. Transformation fails immediately if a range error occurs. If not specified, the default value is <code>false</code> .

The `<set>` descriptor below modifies a member of a dictionary element:

```
<set target="new.parts['P105J3'].cost"
    value="new.parts['P105J3'].cost * 1.05"/>
```

This `<set>` descriptor adds an element to a sequence and initializes its value:

```
<set target="new.partsList" length="new.partsList.length + 1"
    value="'P105J3'"/>
```

As another example, the following `<set>` descriptor changes the value of an enumeration. Notice that the value refers to a symbol in the new Slice definitions (see Section 39.8.3 for more information).

```
<set target="new.ingredient" value="::New::Apple"/>
```

<add>

Adds a new element to a sequence or dictionary. It is legal to add an element while traversing the sequence or dictionary using `<iterate>`, however the traversal order after the addition is undefined. The `key` and `index` attributes are mutually exclusive, as are the `value` and `type` attributes. If neither `value` nor `type` is specified, the new element is initialized with a default value. The attributes supported by this descriptor are described in Table 39.8.

Table 39.8. Attributes for `<add>` descriptor.

Name	Description
<code>target</code>	An expression that must select a modifiable sequence or dictionary.
<code>key</code>	An expression that must evaluate to a value compatible with the target dictionary's key type.
<code>index</code>	An expression that must evaluate to an integer value representing the insertion position. The new element is inserted before <code>index</code> . The value must not exceed the length of the target sequence.
<code>value</code>	An expression that must evaluate to a value compatible with the target dictionary's value type, or the target sequence's element type.
<code>type</code>	If specified, set the target value or element to be an instance of the given Slice class. The value is a type id from the new Slice definitions. The class must be compatible with the target dictionary's value type, or the target sequence's element type.

Table 39.8. Attributes for `<add>` descriptor.

Name	Description
<code>convert</code>	If <code>true</code> , additional type conversions are supported: between integer and floating point, and between integer and enumeration. Transformation fails immediately if a range error occurs. If not specified, the default value is <code>false</code> .

Below is an example of an `<add>` descriptor that adds a new dictionary element and then initializes its member:

```
<add target="new.parts" key="'P105J4'"/>
<set target="new.parts['P105J4'].cost" value="3.15"/>
```

<define>

Defines a new symbol in the current scope. The attributes supported by this descriptor are described in Table 39.9.

Table 39.9. Attributes for `<define>` descriptor.

Name	Description
<code>name</code>	The name of the new symbol. An error occurs if the name matches an existing symbol in the current scope.
<code>type</code>	The name of the symbol's formal Slice type. For user-defined types, the name should be prefixed with <code>::Old</code> or <code>::New</code> to indicate the source of the type. The prefix can be omitted for primitive types.
<code>value</code>	An expression that must evaluate to a value compatible with the symbol's type.
<code>convert</code>	If <code>true</code> , additional type conversions are supported: between integer and floating point, and between integer and enumeration. Execution fails immediately if a range error occurs. If not specified, the default value is <code>false</code> .

Below are two examples of the `<define>` descriptor. The first example defines the symbol `identity` to have type `Ice::Identity`, and proceeds to initialize its members using `<set>`:

```
<define name="identity" type="::New::Ice::Identity"/>
<set target="identity.name" value="steve"/>
<set target="identity.category" value="Admin"/>
```

The second example uses the enumeration we first saw in Section 39.3.5 to define the symbol `manufacturer` and assign it a default value:

```
<define name="manufacturer" type="::New::BigThree"
  value="::New::DaimlerChrysler"/>
```

<remove>

Removes an element from a sequence or dictionary. It is legal to remove an element while traversing a sequence or dictionary using `<iterate>`, however the traversal order after removal is undefined. The attributes supported by this descriptor are described in Table 39.10.

Table 39.10. Attributes for `<remove>` descriptor.

Name	Description
<code>target</code>	An expression that must select a modifiable sequence or dictionary.
<code>key</code>	An expression that must evaluate to a value compatible with the key type of the target dictionary.
<code>index</code>	An expression that must evaluate to an integer value representing the index of the sequence element to be removed.

<fail>

Causes transformation to fail immediately. If `test` is specified, transformation fails only if the expression evaluates to `true`. The attributes supported by this descriptor are described in Table 39.11.

Table 39.11. Attributes for `<fail>` descriptor.

Name	Description
<code>message</code>	A message to display upon transformation failure.
<code>test</code>	A boolean expression.

The following `<fail>` descriptor terminates the transformation if a range error is detected:

```
<fail message="range error occurred in ticket count!"
      test="old.ticketCount > 32767"/>
```

<delete>

Causes transformation of the current database record to cease, and removes the record from the transformed database. This descriptor has no attributes.

<echo>

Displays values and informational messages. If no attributes are specified, only a newline is printed. The attributes supported by this descriptor are described in Table 39.12.

Table 39.12. Attributes for `<echo>` descriptor.

Name	Description
message	A message to display.
value	An expression. The value of the expression is displayed in a structured format.

Shown below is an `<echo>` descriptor that uses both `message` and `value` attributes:

```
<if test="old.ticketCount > 32767">
  <echo message="deleting record with invalid ticket count: "
        value="old.ticketCount"/>
  <delete/>
</if>
```

39.4.5 Descriptor Guidelines

There are three points at which you can intercept the transformation process: when transforming a record (`<record>`), when transforming an instance of a type (`<transform>`), and when creating an instance of a type (`<init>`).

In general, `<record>` is used when your modifications require access to both the key and value of the record. For example, if the database key is needed as a factor in an equation, or to identify an element in a dictionary, then `<record>` is

the only descriptor in which this type of modification is possible. The `<record>` descriptor is also convenient to use when the number of changes to be made is small, and does not warrant the effort of writing separate `<transform>` or `<init>` descriptors.

The `<transform>` descriptor has a more limited scope than `<record>`. It is used when changes must potentially be made to all instances of a type (regardless of the context in which that type is used) and access to the old value is necessary. The `<transform>` descriptor does not have access to the database key and value, therefore decisions can only be made based on the old and new instances of the type in question.

Finally, the `<init>` descriptor is useful when access to the old instance is not required in order to properly initialize a type. In most cases, this activity could also be performed by a `<transform>` descriptor that simply ignored the old instance, so `<init>` may seem redundant. However, there is one situation where `<init>` is required: when it is necessary to initialize an instance of a type that is introduced by the new Slice definitions. Since there are no instances of this type in the current database, a `<transform>` descriptor for that type would never be executed.

39.5 Using `transformdb`

This section describes the invocation of the `transformdb` tool, and provides advice on how best to use it. The tool supports the standard command-line options common to all Slice processors listed in Section 4.19, with the exception of the include directory (`-I`) option. The options specific to `transformdb` are described in the subsections below.

39.5.1 General Options

The following options are used in both automatic and custom migration:

- `--old SLICE`
`--new SLICE`

Loads the old or new Slice definitions contained in the file `SLICE`. These options may be specified multiple times if several files must be loaded. However, it is the user's responsibility to ensure that duplicate definitions do not occur (which is possible when two files are loaded that share a common include file). One strategy for avoiding duplicate definitions is to load a single

Slice containing only `#include` statements for each of the Slice files to be loaded. No duplication is possible in this case if the included files use include guards correctly.

- `--include-old DIR`
`--include-new DIR`

Adds the directory *DIR* to the set of include paths for the old or new Slice definitions.

- `--key TYPE[, TYPE]`
`--value TYPE[, TYPE]`

Specifies the Slice type(s) of the database key and value. If the type does not change, then the type only needs to be specified once. Otherwise, the old type is specified first, followed by a comma and the new type. For example, the option `--key int, string` indicates that the database key is migrating from `int` to `string`. On the other hand, the option `--key int, int` indicates that the key type does not change, and could be given simply as `--key int`. Type changes are restricted to those allowed by the compatibility rules defined in Section 39.3.2, but custom migration provides additional flexibility.

- `-e`

Indicates that a Freeze evictor database is being migrated. This option is required whenever `transformdb` operates on a Freeze evictor database. As a convenience, this option automatically sets the database key and value types to those appropriate for the Freeze evictor, and therefore the `--key` and `--value` options are not necessary. Specifically, the key type of a Freeze evictor database is `Ice::Identity`, and the value type is `Freeze::ObjectRecord`. The latter is defined in the Slice file `Freeze/EvictorStorage.ice`; however, this file does not need to be loaded into your old and new Slice definitions.

- `-i`

Requests that `transformdb` ignore type changes that violate the compatibility rules defined in Section 39.3.2. If this option is not specified, transformation fails immediately if such a violation occurs. With this option, a warning is displayed but transformation continues.

- `-p`

Requests that `transformdb` purge object instances whose type is no longer found in the new Slice definitions. See Section 39.5.5 for more information.

- **-c**
Use catastrophic recovery on the old BerkeleyDB database environment.
- **-w**
Suppress duplicate warnings during transformation.

39.5.2 Database Arguments

If `transformdb` is invoked to transform a database, it requires three arguments:

- **dbenv**
The pathname of the database environment directory.
- **db**
The name of the existing database file. `transformdb` never modifies this database.
- **newdbenv**
The pathname of the database environment directory to contain the transformed database. This directory must exist, and must not contain an existing database whose name matches the **db** argument.

Upon successful transformation, a database of the same name is created in the new environment directory.

39.5.3 Automatic Migration

No additional arguments are necessary to use automatic migration. The standard options from Section 4.19, the general options described in Section 39.5.1, and the database arguments from Section 39.5.2 are all you need. For example, consider the following command, which uses automatic migration to transform a database with a key type of `int` and value type of `string` into a database with the same key type and a value type of `long`:

```
$ transformdb --key int --value string,long dbhome data.db newdbhome
```

Note that we did not need to specify the `--old` or `--new` options because our key and value types are primitives. Upon successful completion, the file `newdb-home/data.db` contains our transformed database.

39.5.4 Custom Migration

Analysis

Custom migration is a two-step process: your first write the transformation descriptors, and then execute them to transform a database. To assist you in the process of creating a descriptor file, **transformdb** can generate a default set of transformation descriptors by comparing your old and new Slice definitions. This feature is called *analysis*, and is enabled by specifying the following option:

- **-o FILE**

Specifies the descriptor file **FILE** to be created during analysis.

No database arguments are required, because transformation does not occur when the **-o** option is specified. The generated file contains a `<transform>` descriptor for each type that appears in both old and new Slice definitions, and an `<init>` descriptor for types that appear only in the new Slice definitions. In most cases, these descriptors are empty. However, they may contain XML comments describing changes detected by **transformdb** that may require action on your part.

For example, let us revisit the enumeration we defined in Section 39.3.5:

```
enum BigThree { Ford, Chrysler, GeneralMotors };
```

This enumeration has evolved into the one shown below. In particular, the `Chrysler` enumerator has been renamed to reflect a corporate merger:

```
enum BigThree { Ford, DaimlerChrysler, GeneralMotors };
```

Next we run **transformdb** in analysis mode:

```
$ transformdb --old old/BigThree.ice --new new/BigThree.ice \  
  --key string --value ::BigThree -o transform.xml
```

The generated file **transform.xml** contains the following descriptor for the enumeration `BigThree`:

```
<transform type="::BigThree">  
  <!-- NOTICE: enumerator `Chrysler' has been removed -->  
</transform>
```

The comment indicates that enumerator `Chrysler` is no longer present in the new definition, reminding us that we need to add logic in this `<transform>` descriptor to change all occurrences of `Chrysler` to `DaimlerChrysler`.

The descriptor file generated by `transformdb` is well-formed and does not require any manual intervention prior to being executed. However, executing an unmodified descriptor file is simply the equivalent of automatic migration.

Transformation

After preparing a descriptor file, either by writing one completely yourself, or modifying one generated by the analysis phase, you are ready to transform a database. One additional option is provided for transformation:

- **-f FILE**

Specifies the descriptor file **FILE** to be executed during transformation.

It is not necessary to provide the **--key** or **--value** options during transformation, because the key and value types are already specified in the file's `<database>` descriptor.

Continuing our enumeration example from the analysis discussion above, assume we have modified `transform.xml` to convert the Chrysler enumerator, and are now ready to execute the transformation:

```
$ transformdb --old old/BigThree.ice --new new/BigThree.ice \  
    -f transform.xml dbhome bigthree.db newbigthree.db
```

Strategies

If it becomes necessary for you to transform a Freeze database, we generally recommend that you attempt to use automatic migration first, unless you already know that custom migration is necessary. Since transformation is a non-destructive process, there is no harm in attempting an automatic migration, and it is a good way to perform a sanity check on your `transformdb` arguments (for example, to ensure that all the necessary Slice files are being loaded), as well as on the database itself. If `transformdb` detects any incompatible type changes, it displays an error message for each incompatible change and terminates without doing any transformation. In this case, you may want to run `transformdb` again with the **-i** option, which ignores incompatible changes and causes transformation to proceed.

Pay careful attention to any warnings that `transformdb` emits, as these may indicate the need for using custom migration. For example, if we had attempted to transform the database containing the `BigThree` enumeration from previous sections using automatic migration, any occurrences of the Chrysler enumerator would display the following warning:

```
warning: unable to convert 'Chrysler' to ::BigThree
```

If custom migration appears to be necessary, use analysis to generate a default descriptor file, then review it for NOTICE comments and edit as necessary. Liberal use of the `<echo>` descriptor can be beneficial when testing your descriptor file, especially from within the `<record>` descriptor where you can display old and new keys and values.

39.5.5 Transforming Objects

The polymorphic nature of Slice classes can cause problems for database migration. As an example, the Slice parser can ensure that a set of Slice definitions loaded into `transformdb` is complete for all types but classes (and exceptions, but we ignore those because they are not persistent). `transformdb` cannot know that a database may contain instances of a subclass derived from one of the loaded classes, but itself is not loaded. Alternatively, the type of a class instance may have been renamed and cannot be found in the new Slice definitions.

By default, these situations result in immediate transformation failure. However, the `-p` option is a (potentially drastic) way to handle these situations: if a class instance has no equivalent in the new Slice definitions and this option is specified, `transformdb` removes the instance any way it can. If the instance appears in a sequence or dictionary element, that element is removed. Otherwise, the database record containing the instance is deleted.

Now, the case of a class type being renamed is handled easily enough using custom migration and the `rename` attribute of the `<transform>` descriptor. However, there are legitimate cases where the destructive nature of the `-p` option can be useful. For example, if a class type has been removed and it is simply easier to start with a database that is guaranteed not to contain any instances of that type, then the `-p` option may simplify the broader migration effort.

This is another situation in which running an automatic migration first can help point out the trouble spots in a potential migration. Using the `-p` option, `transformdb` emits a warning about the missing class type and continues, rather than halting at the first occurrence, enabling you to discover whether you have forgotten to load some Slice definitions, or need to rename a type.

39.6 Database Inspection

The FreezeScript tool `dumpdb` is used to examine a Freeze database. Its simplest invocation displays every record of the database, but the tool also supports more

selective activities. In fact, **dumpdb** supports a scripted mode that shares many of the same XML descriptors as **transformdb** (see Section 39.4), enabling sophisticated filtering and reporting.

39.6.1 Descriptor Overview

A **dumpdb** descriptor file has a well-defined structure. The top-level descriptor in the file is `<dumpdb>`. A `<database>` descriptor must be present within `<dumpdb>` to define the key and value types used by the database. Inside `<database>`, the `<record>` descriptor triggers database traversal. Shown below is an example that demonstrates the structure of a minimal descriptor file:

```
<dumpdb>
  <database key="string" value="::Employee">
    <record>
      <echo message="Key: " value="key"/>
      <echo message="Value: " value="value"/>
    </record>
  </database>
</dumpdb>
```

During traversal, type-specific actions are supported by the `<dump>` descriptor, which is a child of `<dumpdb>`. One `<dump>` descriptor may be defined for each type in the new Slice definitions. Each time **dumpdb** encounters an instance of a type, the `<dump>` descriptor for the type is executed.

The `<database>`, `<record>`, and `<dump>` descriptors may contain general-purpose action descriptors such as `<if>` and `<echo>`. These actions resemble statements in programming languages like C++ and Java, in that they are executed in the order of definition and their effects are cumulative. Actions make use of the expression language described in Section 39.8.

Although **dumpdb** descriptors are not allowed to modify the database, they can still define local symbols for scripting purposes. Once a symbol is defined by the `<define>` descriptor, other descriptors such as `<set>`, `<add>`, and `<remove>` can be used to manipulate the symbol's value.

39.6.2 Flow of Execution

The descriptors are executed as described below.

- `<database>` is executed first. Each child descriptor of `<database>` is executed in the order of definition. If a `<record>` descriptor is present, data-

base traversal occurs at that point. Any child descriptors of `<database>` that follow `<record>` are not executed until traversal completes.

- For each record, **dumpdb** interprets the key and value, invoking `<dump>` descriptors for each type it encounters. For example, if the value type of the database is a `struct`, then **dumpdb** first attempts to invoke a `<dump>` descriptor for the `struct` type, and then recursively interprets the structure's members in the same fashion.

See Section 39.6.4 for detailed information on the **dumpdb** descriptors.

39.6.3 Scopes

The `<database>` descriptor creates a global scope, allowing child descriptors of `<database>` to define symbols that are accessible in any descriptor³. Furthermore, certain other descriptors create local scopes that exist only for the duration of the descriptor's execution. For example, the `<dump>` descriptor creates a local scope and defines the symbol `value` to represent a value of the specified type. Child descriptors of `<dump>` can also define new symbols in the local scope, as long as those symbols do not clash with an existing symbol in that scope. It is legal to add a new symbol with the same name as a symbol in an outer scope, but the outer symbol will not be accessible during the descriptor's execution.

The global scope is useful in many situations. For example, suppose you want to track the number of times a certain value was encountered during database traversal. This can be accomplished as shown below:

```
<dumpdb>
  <database key="string" value="::Ice::Identity">
    <define name="categoryCount" type="int" value="0"/>
    <record/>
    <echo message="categoryCount = " value="categoryCount"/>
  </database>
  <dump type="::Ice::Identity">
    <if test="new.category == 'Accounting'">
      <set target="categoryCount" value="categoryCount + 1"/>
    </if>
  </dump>
</dumpdb>
```

3. In order for a global symbol to be available to a `<dump>` descriptor, the symbol must be defined before the `<record>` descriptor is executed.

In this example, the `<define>` descriptor introduces the symbol `categoryCount` into the global scope, defining it as type `int` with an initial value of zero. Next, the `<record>` descriptor causes traversal to proceed. Each occurrence of the type `Ice::Identity` causes its `<dump>` descriptor to be executed, which examines the `category` member and increases `categoryCount` if necessary. Finally, after traversal completes, the `<echo>` descriptor displays the final value of `categoryCount`.

To reinforce the relationships between descriptors and scopes, consider the diagram in Figure 39.2. Several descriptors are shown, including the symbols they define in their local scopes. In this example, the `<iterate>` descriptor has a dictionary target and therefore the default symbol for the element value, `value`, hides the symbol of the same name in the parent `<dump>` descriptor's scope⁴. In addition to symbols in the `<iterate>` scope, child descriptors of `<iterate>` can also refer to symbols from the `<dump>` and `<database>` scopes.

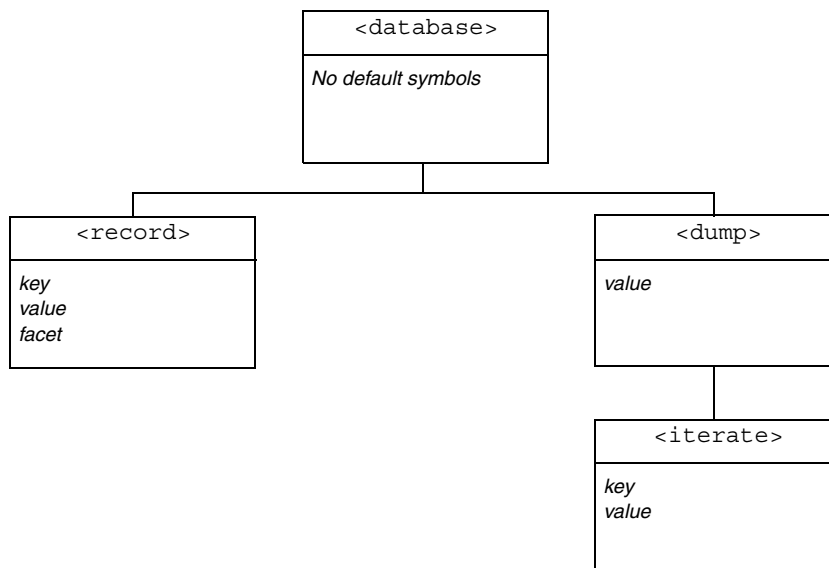

Figure 39.2. Relationship between descriptors and scopes.

4. This situation can be avoided by assigning a different symbol name to the element value.

39.6.4 Descriptor Reference

<dumpdb>

The top-level descriptor in a descriptor file. It requires one child descriptor, <database>, and supports any number of <dump> descriptors. This descriptor has no attributes.

<database>

The attributes of this descriptor define the key and value types of the database. It supports any number of child descriptors, but at most one <record> descriptor. The <database> descriptor also creates a global scope for user-defined symbols (see Section 39.6.3).

The attributes supported by the <database> descriptor are described in Table 39.13.

Table 39.13. Attributes for <database> descriptor.

Name	Description
key	Specifies the Slice type of the database key.
value	Specifies the Slice type of the database value.

As an example, consider the following <database> descriptor. In this case, the Freeze map to be examined has key type `int` and value type `::Employee`:

```
<database key="int" value="::Employee">
```

<record>

Commences the database traversal. Child descriptors are executed for each record in the database, but after any <dump> descriptors are executed. The <record> descriptor introduces the read-only symbols `key`, `value` and `facet` into a local scope. These symbols are accessible to child descriptors, but not to <dump> descriptors. The `facet` symbol is a string indicating the facet name of the object in the current record, and is only relevant for Freeze evictor databases.

Note that database traversal only occurs if a <record> descriptor is present.

<dump>

Executed for all instances of a Slice type. Only one <dump> descriptor can be specified for a type, but a <dump> descriptor is not required for every type. The read-only symbol `value` is introduced into a local scope. The attributes supported by this descriptor are described in Table 39.14.

Table 39.14. Attributes for <dump> descriptor.

Name	Description
<code>type</code>	Specifies the Slice type id.
<code>base</code>	If <code>type</code> denotes a Slice class, this attribute determines whether the <dump> descriptor of the base class is invoked. If <code>true</code> , the base class descriptor is invoked after executing the child descriptors. If not specified, the default value is <code>true</code> .
<code>contents</code>	For <code>class</code> and <code>struct</code> types, this attribute determines whether descriptors are executed for members of the value. For <code>sequence</code> and <code>dictionary</code> types, this attribute determines whether descriptors are executed for elements. If not specified, the default value is <code>true</code> .

Below is an example of a <dump> descriptor that searches for certain products:

```
<dump type="::Product">
  <if test="value.description.find('scanner') != -1">
    <echo message="Scanner SKU: " value="value.SKU"/>
  </if>
</dump>
```

For class types, **dumpdb** first attempts to locate a <dump> descriptor for the object's most-derived type. If no descriptor is found, **dumpdb** proceeds up the class hierarchy in an attempt to find a descriptor. The base object type, `Object`, is the root of every class hierarchy and is included in the search for descriptors. It is therefore possible to define a <dump> descriptor for type `Object`, which will be invoked for every class instance.

Note that <dump> descriptors are executed recursively. For example, consider the following Slice definitions:

```

struct Inner {
    int sum;
};
struct Outer {
    Inner i;
};

```

When **dumpdb** is interpreting a value of type `Outer`, it executes the `<dump>` descriptor for `Outer`, then recursively executes the `<dump>` descriptor for the `Inner` member, but only if the `contents` attribute of the `Outer` descriptor has the value `true`.

<iterate>

Iterates over a dictionary or sequence, executing child descriptors for each element. The symbol names selected to represent the element information may conflict with existing symbols in the enclosing scope, in which case those outer symbols are not accessible to child descriptors. The attributes supported by this descriptor are described in Table 39.15.

Table 39.15. Attributes for `<iterate>` descriptor.

Name	Description
<code>target</code>	The sequence or dictionary.
<code>index</code>	The symbol name used for the sequence index. If not specified, the default symbol is <code>i</code> .
<code>element</code>	The symbol name used for the sequence element. If not specified, the default symbol is <code>elem</code> .
<code>key</code>	The symbol name used for the dictionary key. If not specified, the default symbol is <code>key</code> .
<code>value</code>	The symbol name used for the dictionary value. If not specified, the default symbol is <code>value</code> .

Shown below is an example of an `<iterate>` descriptor that displays the name of an employee if the employee's salary is greater than \$3000.

```

<iterate target="value.employeeMap" key="id" value="emp">
  <if test="emp.salary > 3000">
    <echo message="Employee: " value="emp.name"/>
  </if>
</iterate>

```

<if>

Conditionally executes child descriptors. The attributes supported by this descriptor are described in Table 39.16.

Table 39.16. Attributes for <if> descriptor.

Name	Description
test	A boolean expression.

See Section 39.8 for more information on the descriptor expression language.

<set>

Modifies a value. The `value` and `type` attributes are mutually exclusive. If `target` denotes a dictionary element, that element must already exist (i.e., <set> cannot be used to add an element to a dictionary). The attributes supported by this descriptor are described in Table 39.17.

Table 39.17. Attributes for <set> descriptor.

Name	Description
target	An expression that must select a modifiable value.
value	An expression that must evaluate to a value compatible with the target's type.
type	The Slice type id of a class to be instantiated. The class must be compatible with the target's type.
length	An integer expression representing the desired new length of a sequence. If the new length is less than the current size of the sequence, elements are removed from the end of the sequence. If the new length is greater than the current size, new elements are added to the end of the sequence. If <code>value</code> or <code>type</code> is also specified, it is used to initialize each new element.
convert	If <code>true</code> , additional type conversions are supported: between integer and floating point, and between integer and enumeration. Transformation fails immediately if a range error occurs. If not specified, the default value is <code>false</code> .

The `<set>` descriptor below modifies a member of a dictionary element:

```
<set target="new.parts['P105J3'].cost"
      value="new.parts['P105J3'].cost * 1.05"/>
```

This `<set>` descriptor adds an element to a sequence and initializes its value:

```
<set target="new.partsList" length="new.partsList.length + 1"
      value="'P105J3'"/>
```

`<add>`

Adds a new element to a sequence or dictionary. It is legal to add an element while traversing the sequence or dictionary using `<iterate>`, however the traversal order after the addition is undefined. The `key` and `index` attributes are mutually exclusive, as are the `value` and `type` attributes. If neither `value` nor `type` is specified, the new element is initialized with a default value. The attributes supported by this descriptor are described in Table 39.18.

Table 39.18. Attributes for `<add>` descriptor.

Name	Description
<code>target</code>	An expression that must select a modifiable sequence or dictionary.
<code>key</code>	An expression that must evaluate to a value compatible with the target dictionary's key type.
<code>index</code>	An expression that must evaluate to an integer value representing the insertion position. The new element is inserted before <code>index</code> . The value must not exceed the length of the target sequence.
<code>value</code>	An expression that must evaluate to a value compatible with the target dictionary's value type, or the target sequence's element type.
<code>type</code>	The Slice type id of a class to be instantiated. The class must be compatible with the target dictionary's value type, or the target sequence's element type.
<code>convert</code>	If <code>true</code> , additional type conversions are supported: between integer and floating point, and between integer and enumeration. Transformation fails immediately if a range error occurs. If not specified, the default value is <code>false</code> .

Below is an example of an `<add>` descriptor that adds a new dictionary element and then initializes its member:

```
<add target="new.parts" key="'P105J4'"/>
<set target="new.parts['P105J4'].cost" value="3.15"/>
```

<define>

Defines a new symbol in the current scope. The attributes supported by this descriptor are described in Table 39.19.

Table 39.19. Attributes for `<define>` descriptor.

Name	Description
name	The name of the new symbol. An error occurs if the name matches an existing symbol in the current scope.
type	The name of the symbol's formal Slice type.
value	An expression that must evaluate to a value compatible with the symbol's type.
convert	If <code>true</code> , additional type conversions are supported: between integer and floating point, and between integer and enumeration. Execution fails immediately if a range error occurs. If not specified, the default value is <code>false</code> .

Below are two examples of the `<define>` descriptor. The first example defines the symbol `identity` to have type `Ice::Identity`, and proceeds to initialize its members using `<set>`:

```
<define name="identity" type="::Ice::Identity"/>
<set target="identity.name" value="steve"/>
<set target="identity.category" value="Admin"/>
```

The second example uses the enumeration we first saw in Section 39.3.5 to define the symbol `manufacturer` and assign it a default value:

```
<define name="manufacturer" type="::BigThree"
  value="::DaimlerChrysler"/>
```

<remove>

Removes an element from a sequence or dictionary. It is legal to remove an element while traversing a sequence or dictionary using `<iterate>`, however

the traversal order after removal is undefined. The attributes supported by this descriptor are described in Table 39.20.

Table 39.20. Attributes for `<remove>` descriptor.

Name	Description
target	An expression that must select a modifiable sequence or dictionary.
key	An expression that must evaluate to a value compatible with the key type of the target dictionary.
index	An expression that must evaluate to an integer value representing the index of the sequence element to be removed.

<fail>

Causes transformation to fail immediately. If `test` is specified, transformation fails only if the expression evaluates to `true`. The attributes supported by this descriptor are described in Table 39.21.

Table 39.21. Attributes for `<fail>` descriptor.

Name	Description
message	A message to display upon transformation failure.
test	A boolean expression.

The following `<fail>` descriptor terminates the transformation if a range error is detected:

```
<fail message="range error occurred in ticket count!"
      test="value.ticketCount > 32767"/>
```

<echo>

Displays values and informational messages. If no attributes are specified, only a newline is printed. The attributes supported by this descriptor are described in Table 39.22.

Table 39.22. Attributes for <echo> descriptor.

Name	Description
message	A message to display.
value	An expression. The value of the expression is displayed in a structured format.

Shown below is an <echo> descriptor that uses both message and value attributes:

```
<if test="value.ticketCount > 32767">
  <echo message="range error occurred in ticket count: "
    value="value.ticketCount"/>
</if>
```

39.7 Using `dumpdb`

This section describes the invocation of `dumpdb` and provides advice on how to best use it.

39.7.1 Options

The tool supports the standard command-line options common to all Slice processors listed in Section 4.19. The options specific to `dumpdb` are described below:

- `--load SLICE`

Loads the Slice definitions contained in the file *SLICE*. This option may be specified multiple times if several files must be loaded. However, it is the user's responsibility to ensure that duplicate definitions do not occur (which is possible when two files are loaded that share a common include file). One strategy for avoiding duplicate definitions is to load a single Slice containing

only `#include` statements for each of the Slice files to be loaded. No duplication is possible in this case if the included files use include guards correctly.

- **--key TYPE**
--value TYPE
Specifies the Slice type of the database key and value.
- **-e**
Indicates that a Freeze evictor database is being examined. This option is required whenever `dumpdb` operates on a Freeze evictor database. As a convenience, this option automatically sets the database key and value types to those appropriate for the Freeze evictor, and therefore the **--key** and **--value** options are not necessary. Specifically, the key type of a Freeze evictor database is `Ice::Identity`, and the value type is `Freeze::ObjectRecord`. The latter is defined in the Slice file `Freeze/EvictorStorage.ice`, however this file does not need to be explicitly loaded.
- **-o FILE**
Create a file named **FILE** containing sample descriptors for the loaded Slice definitions. The key and value types must be specified using the **--key** and **--value** options, or using the **-e** option. If the **--select** option is used, its expression is included in the sample descriptors. The database arguments are not necessary because database traversal is not performed when the **-o** option is used.
- **-f FILE**
Execute the descriptors in the file named **FILE**. The file's `<database>` descriptor specifies the key and value types, therefore the **--key**, **--value** and **-e** options are not necessary when **-f** is used.
- **--select EXPR**
Only display those records for which the expression **EXPR** is true. The expression can refer to the symbols `key` and `value`.

39.7.2 Database Arguments

If `dumpdb` is invoked to examine a database, it requires two arguments:

- **dbenv**
The pathname of the database environment directory.

- **db**

The name of the database file. `dumpdb` opens this database as read-only, and traversal occurs within a transaction.

39.7.3 Use Cases

The command line options described in Section 39.7.1 support several modes of operation:

- Dump an entire database.
- Dump selected records of a database.
- Emit a sample descriptor file.
- Execute a descriptor file.

These use cases are described in the following sections.

Dump an Entire Database

The simplest way to examine a database with `dumpdb` is to dump its entire contents. You must specify the database key and value types, load the necessary Slice definitions, and supply the names of the database environment directory and database file. For example, this command dumps a Freeze map database whose key type is `string` and value type is `Employee`:

```
$ dumpdb --key string --value ::Employee --load Employee.ice \  
db emp.db
```

Dump Selected Records

If only certain records are of interest to you, the `--select` option provides a convenient way to filter the output of `dumpdb`. In the following example, we select employees from the accounting department:

```
$ dumpdb --key string --value ::Employee --load Employee.ice \  
--select "value.dept == 'Accounting'" db emp.db
```

In cases where the database records contain polymorphic class instances, you must be careful to specify an expression that can be successfully evaluated against all records. For example, `dumpdb` fails immediately if, while evaluating the expression, a data member is encountered that does not exist in the class instance. The safest way to write an expression in this case is to check the type of the class instance before referring to any of its data members.

In the example below, we assume that a Freeze evictor database contains instances of various classes in a class hierarchy, and we are only interested in instances of `Manager` whose employee count is greater than 10:

```
$ dumpdb -e --load Employee.ice \  
  --select "value.servant.ice_id == '::Manager' and \  
  value.servant.group.length > 10" db emp.db
```

Alternatively, if `Manager` has derived classes, then the expression can be written in a different way so that instances of `Manager` and any of its derived classes are considered:

```
$ dumpdb -e --load Employee.ice \  
  --select "value.servant.ice_isA('::Manager') and \  
  value.servant.group.length > 10" db emp.db
```

Creating a Sample Descriptor File

If you require more sophisticated filtering or scripting capabilities, then you must use a descriptor file. The easiest way to get started with a descriptor file is to generate a template using `dumpdb`:

```
$ dumpdb --key string --value ::Employee --load Employee.ice \  
  -o dump.xml
```

The output file `dump.xml` is complete and can be executed immediately if desired, but typically the file is used as a starting point for further customization.

If the `--select` option is specified, its expression is included in the generated `<record>` descriptor as the value of the `test` attribute in an `<if>` descriptor.

Notice that database arguments are not required when `-o` is specified, because `dumpdb` terminates immediately after generating the sample file.

Executing a Descriptor File

Use the `-f` option when you are ready to execute a descriptor file. For example, we can execute the descriptor we generated in the previous section using this command:

```
$ dumpdb -f dump.xml --load Employee.ice db emp.db
```

39.8 Descriptor Expression Language

An expression language is provided for use in FreezeScript descriptors.

39.8.1 Operators

The language supports the usual complement of operators: `and`, `or`, `not`, `+`, `-`, `/`, `*`, `%`, `<`, `>`, `==`, `!=`, `<=`, `>=`, `(`, `)`. Note that the `<` character must be escaped as `<t`; in order to comply with XML syntax restrictions.

39.8.2 Literals

Literal values can be specified for integer, floating point, boolean, and string. The expression language supports the same syntax for literal values as that of Slice (see Section 4.9.5), with one exception: string literals must be enclosed in single quotes.

39.8.3 Symbols

Certain descriptors introduce symbols that can be used in expressions. These symbols must comply with the naming rules for Slice identifiers (i.e., a leading letter followed by zero or more alphanumeric characters). Data members are accessed using dotted notation, such as `value.memberA.memberB`.

Expressions can refer to Slice constants and enumerators using scoped names. In a `transformdb` descriptor, there are two sets of Slice definitions, therefore the expression must indicate which set of definitions it is accessing by prefixing the scoped name with `::Old` or `::New`. For example, the expression `old.fruitMember == ::Old::Pear` evaluates to `true` if the data member `fruitMember` has the enumerated value `Pear`. In `dumpdb`, only one set of Slice definitions is present and therefore the constant or enumerator can be identified without any special prefix.

39.8.4 Nil

The keyword `nil` represents a nil value of type `Object`. This keyword can be used in expressions to test for a nil object value, and can also be used to set an object value to nil.

39.8.5 Elements

Dictionary and sequence elements are accessed using array notation, such as `userMap['marc']` or `stringSeq[5]`. An error occurs if an expression attempts to access a dictionary or sequence element that does not exist. For dictio-

naries, the recommended practice is to check for the presence of a key before accessing it:

```
<if test="userMap.containsKey('marc') and userMap['marc'].active">
```

See Section 39.8.8 for more information on the `containsKey` function.

Similarly, expressions involving sequences should check the length of the sequence:

```
<if test="stringSeq.length > 5 and stringSeq[5] == 'fruit'">
```

See Section 39.8.7 for details on the `length` member.

39.8.6 Reserved Keywords

The following keywords are reserved: `and`, `or`, `not`, `true`, `false`, `nil`.

39.8.7 Implicit Members

Certain `Slice` types support implicit data members:

- Dictionary and sequence instances have a member `length` representing the number of elements.
- Object instances have a member `ice_id` denoting the actual type of the object.

39.8.8 Functions

The expression language supports two forms of function invocation: member functions and global functions. A member function is invoked on a particular data value, whereas global functions are not bound to a data value. For instance, here is an expression that invokes the `find` member function of a `string` value:

```
old.stringValue.find('theSubstring') != -1
```

And here is an example that invokes the global function `stringToIdentity`:

```
stringToIdentity(old.stringValue)
```

If a function takes multiple arguments, the arguments must be separated with commas.

String Member Functions

The `string` data type supports the following member functions:

- `int find(string match[, int start])`
Returns the index of the substring, or -1 if not found. A starting position can optionally be supplied.
- `string replace(int start, int len, string str)`
Replaces a given portion of the string with a new substring, and returns the modified string.
- `string substr(int start[, int len])`
Returns a substring beginning at the given start position. If the optional length argument is supplied, the substring contains at most len characters, otherwise the substring contains the remainder of the string.

Dictionary Member Functions

The dictionary data type supports the following member function:

- `bool containsKey(key)`
Returns `true` if the dictionary contains an element with the given key, or `false` otherwise. The key argument must have a value that is compatible with the dictionary's key type.

Object Member Functions

Object instances support the following member function:

- `bool ice_isA(string id)`
Returns `true` if the object implements the given interface type, or `false` otherwise. This function cannot be invoked on a nil object.

Global Functions

The following global functions are provided:

- `string generateUUID()`
Returns a new UUID.
- `string identityToString(Ice::Identity id)`
Converts an identity into its string representation.
- `string lowercase(string str)`
Returns a new string converted to lowercase.
- `string proxyToString(Ice::ObjectPrx prx)`
Returns the string representation of the given proxy.

- `Ice::Identity stringToIdentity(string str)`
Converts a string into an `Ice::Identity`.
- `Ice::ObjectPrx stringToProxy(string str)`
Converts a string into a proxy.
- `string typeOf(val)`
Returns the formal Slice type of the argument.

39.9 Summary

FreezeScript provides tools that ease the maintenance of Freeze databases. The **transformdb** tool simplifies the task of migrating a database when its persistent types have changed, offering an automatic mode requiring no manual intervention, and a custom mode in which scripted changes are possible. Database inspection and reporting is accomplished using the **dumpdb** tool, which supports a number of operational modes including a scripting capability.

Chapter 40

IceSSL

40.1 Chapter Overview

In this chapter we present IceSSL, an optional security component for Ice applications. Section 40.2 provides an overview of the SSL protocol and the infrastructure required to support it. Section 40.3 discusses the installation requirements for each supported language mapping, while Section 40.4 describes typical configuration scenarios. For programs that need to interact directly with IceSSL, the application programming interface is covered in Section 40.5 and Section 40.6. To set up your own certificate authority, you can use the utilities described in Section 40.7.

40.2 Introduction

Security is an important consideration for many distributed applications, both within corporate intranets as well as over untrusted networks, such as the Internet. The ability to protect sensitive information, ensure its integrity, and verify the identities of the communicating parties is essential for developing secure applications. With those goals in mind, Ice includes the IceSSL *plug-in* that provides these capabilities using the Secure Socket Layer (SSL) protocol.¹

40.2.1 SSL Overview

SSL is the protocol that enables Web browsers to conduct secure transactions and therefore is one of the most commonly used protocols for secure network communication. You do not need to know the technical details of the SSL protocol in order to use IceSSL successfully (and those details are outside the scope of this text). However, it would be helpful to have a high-level understanding of how the protocol works and the infrastructure required to support it. (For more information on the SSL protocol, see [24].)

SSL provides a secure environment for communication (without sacrificing too much performance) by combining a number of cryptographic techniques:

- public key encryption
- symmetric (shared key) encryption
- message authentication codes
- digital certificates

When a client establishes an SSL connection to a server, a *handshake* is performed. During a typical handshake, digital certificates that identify the communicating parties are validated, and symmetric keys are exchanged for encrypting the session traffic. Public key encryption, which is too slow to be used for the bulk of a session's data transfer, is used heavily during the handshaking phase. Once the handshake is complete, SSL uses message authentication codes to ensure data integrity, allowing the client and server to communicate at will with reasonable assurance that their messages are secure.

40.2.2 Public Key Infrastructure

Security requires trust, and public key cryptography by itself does nothing to establish trust. SSL addresses the issue of trust using Public Key Infrastructure (PKI), which binds public keys to identities using certificates. A certificate *issuer* creates a certificate for an entity, called the *subject*. The subject is often a person, but it may also be a computer or a specific application. The subject's identity is represented by a *distinguished name*, which includes information such as the subject's name, organization and location. A certificate alone is not sufficient to

1. IceSSL is available for C++, Java and .NET 2.0 applications. Python, PHP and Ruby applications can use IceSSL for C++ via configuration.

establish the subject's identity, however, as anyone can create a certificate for a particular distinguished name.

In order to authenticate a certificate, we need a third-party to guarantee that the certificate belongs to the subject described by the distinguished name. This third party, called a Certificate Authority (CA), expresses this guarantee by using its own private key to sign the subject's certificate. Combining the CA's certificate with the subject's certificate forms a *certificate chain* that provides SSL with most of the information it needs to authenticate the remote peer. In many cases, the chain contains only the aforementioned two certificates, but it is also possible for the chain to be longer when the *root CA* issues a certificate that the subject may use to sign other certificates. Regardless of the length of the chain, this scheme can only work if we trust that the root CA has sufficiently verified the identity of the subject before issuing the certificate.

An implementation of the SSL protocol also needs to know which root CAs we trust. An application supplies that information as a list of certificates representing the trusted root CAs. With that list in hand, the SSL implementation authenticates a peer by obtaining the peer's certificate chain and examining it carefully for validity. If we view the chain as a hierarchy with the root CA certificate at the top and the peer's certificate at the bottom, we can describe SSL's validation activities as follows:

- The root CA certificate must be self-signed and be present among the application's trusted CA certificates.
- All other certificates in the chain must be signed by the one immediately preceding it.
- The certificates must not be expired or revoked.

These tests certify that the chain is valid, but applications often require the chain to undergo more intensive scrutiny (see Section 40.4.5).

Commercial CAs exist to supply organizations with a reliable source of certificates, but in many cases a private CA is completely sufficient. You can create and manage your CA using freely-available tools, and in fact Ice includes a collection of utilities that simplify this process (see Section 40.7).

Depending on your implementation language, it may also be possible to avoid the use of certificates altogether; encryption is still used to obscure the session traffic, but the benefits of authentication are sacrificed in favor of reduced complexity and administration.

For more information on PKI, see [5].

40.2.3 Requirements

Integrating IceSSL into your application often requires no changes to your source code, but does involve the following administrative tasks:

- creating a public key infrastructure (if necessary)
- configuring the IceSSL plug-in
- modifying your application's configuration to install the IceSSL plug-in and use secure connections

The remainder of this chapter discusses plug-in configuration and programming.

40.3 Using IceSSL

Incorporating IceSSL into your application requires installing the plug-in, configuring it according to your security requirements, and creating SSL endpoints.

40.3.1 Installing IceSSL

Ice supports a generic plug-in facility that allows extensions (such as IceSSL) to be installed dynamically without changing the application source code. The `Ice.Plugin` property (see Appendix C) provides language-specific information that enables the Ice run time to install a plug-in.

C++ Applications

The executable code for the IceSSL C++ plug-in resides in a shared library on Unix and a dynamic link library (DLL) on Windows. The format for the `Ice.Plugin` property is shown below:

```
Ice.Plugin.IceSSL=IceSSL:createIceSSL
```

The last component of the property name (`IceSSL`) becomes the plug-in's official identifier for configuration purposes, but the IceSSL plug-in requires its identifier to be `IceSSL`. The property value `IceSSL:createIceSSL` is sufficient to allow the Ice run time to locate the IceSSL library (on both Unix and Windows) and initialize the plug-in. The only requirement is that the library reside in a directory that appears in the shared library path (`LD_LIBRARY_PATH` on most Unix platforms, `PATH` on Windows).

Additional configuration properties are usually necessary as well; see Section 40.4 for more information.

Java Applications

The format for the `Ice.Plugin` property is shown below:

```
Ice.Plugin.IceSSL=IceSSL.PluginFactory
```

The last component of the property name (`IceSSL`) becomes the plug-in's official identifier for configuration purposes, but the `IceSSL` plug-in requires its identifier to be `IceSSL`. The property value `IceSSL.PluginFactory` is the name of a class that allows the Ice run time to initialize the plug-in. The `IceSSL` classes are included in `Ice.jar`, therefore no additional changes to your `CLASSPATH` are necessary.

Due to technical limitations in Java2's SSL implementation, it is not possible to use `IceSSL` in conjunction with the "thread pool" threading model that the Ice run time uses by default. To use `IceSSL` in a Java2 application, you must select an alternate threading model called "thread per connection" by defining the following configuration property:

```
Ice.ThreadPerConnection=1
```

This property must be defined for each communicator in which the `IceSSL` plug-in is installed. When using a Java5 version of the Ice run time, you may use either threading model. Refer to Section 31.9 for details on the Ice threading models.

Additional configuration properties are usually necessary as well; see Section 40.4 for more information.

.NET 2.0 Applications

The format for the `Ice.Plugin` property is shown below:

```
Ice.Plugin.IceSSL=C:/Ice/bin/icesslcs.dll:IceSSL.PluginFactory
```

The last component of the property name (`IceSSL`) becomes the plug-in's official identifier for configuration purposes, but the `IceSSL` plug-in requires its identifier to be `IceSSL`. The property value contains the filename of the `IceSSL` assembly as well as the name of a class, `IceSSL.PluginFactory`, that allows the Ice run time to initialize the plug-in. As described in Appendix C, you may also specify the full assembly name instead of the filename in an `Ice.Plugin` property.

Due to technical limitations in the .NET 2.0 SSL implementation, it is not possible to use `IceSSL` in conjunction with the "thread pool" threading model that the Ice run time uses by default. To use `IceSSL` in a .NET 2.0 application, you must select an alternate threading model called "thread per connection" by defining the following configuration property:

```
Ice.ThreadPerConnection=1
```

This property must be defined for each communicator in which the IceSSL plug-in is installed. Refer to Section 31.9 for details on the Ice threading models.

Additional configuration properties are usually necessary as well; see Section 40.4.3 for more information.

40.3.2 Creating SSL Endpoints

Installing the IceSSL plug-in enables you to use a new protocol, `ssl`, in your endpoints. For example, the following endpoint list creates a TCP endpoint, an SSL endpoint, and a UDP endpoint:

```
MyAdapter.Endpoints=tcp -p 8000:ssl -p 8001:udp -p 8000
```

As this example demonstrates, it is possible for a UDP endpoint to use the same port number as a TCP or SSL endpoint, because UDP is a different protocol and therefore has its own set of ports. It is not possible for a TCP endpoint and an SSL endpoint to use the same port number, because SSL is essentially a layer over TCP.

Using SSL in stringified proxies is equally straightforward:

```
MyProxy=MyObject:tcp -p 8000:ssl -p 8001:udp -p 8000
```

For more information on proxies and endpoints, see Appendix D.

40.3.3 Security Considerations

Defining an object adapter's endpoints to use multiple protocols, as shown in the example in Section 40.3.2, has obvious security implications. If your intent is to use SSL to protect session traffic and/or restrict access to the server, then you should only define SSL endpoints.

There can be situations, however, in which insecure endpoint protocols are advantageous. Figure 40.1 illustrates an environment in which TCP endpoints are allowed behind the firewall, but external clients are required to use SSL.

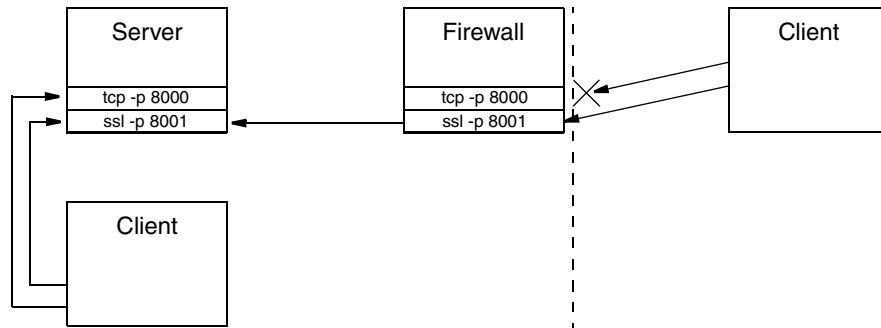

Figure 40.1. An application of multiple protocol endpoints.

The firewall in Figure 40.1 is configured to block external access to TCP port 8000 and to forward connections to port 8001 to the server machine.

One reason for using TCP behind the firewall is that it is more efficient than SSL and requires less administrative work to use. Of course, this scenario assumes that internal clients can be trusted, which is not true in many environments.

For more information on using SSL in complex network architectures, see Chapter 41.

40.4 Configuring IceSSL

After installing IceSSL as described in Section 40.3.1, an application typically needs to define a handful of additional properties to configure settings such as the location of certificate and key files. This section provides an introduction to configuring the plug-in for each of the supported language mappings. For a complete listing of the IceSSL configuration properties, see Appendix C.

40.4.1 C++

Our first example shows the properties that are sufficient in many situations:

```
Ice.Plugin.IceSSL=IceSSL:createIceSSL
IceSSL.DefaultDir=/opt/certs
IceSSL.CertFile=pubkey.pem
IceSSL.KeyFile=privkey.pem
IceSSL.CertAuthFile=ca.pem
IceSSL.Password=password
```

The `IceSSL.DefaultDir` property is a convenient way to specify the default location of your certificate and key files. The three properties that follow it define the files containing the program's certificate, private key, and trusted CA certificate, respectively. This example assumes the files contain RSA keys, and IceSSL requires the files to use the Privacy Enhanced Mail (PEM) encoding. Finally, the `IceSSL.Password` property specifies the password of the private key.

Note that it is a security risk to define a password in a plain text file, such as an Ice configuration file, because anyone who can gain read access to your configuration file can obtain your password. See Section 40.6.1 for alternate ways to supply IceSSL with a password.

DSA Example

If you used DSA to generate your keys, one additional property is necessary:

```
Ice.Plugin.IceSSL=IceSSL:createIceSSL
IceSSL.DefaultDir=/opt/certs
IceSSL.CertFile=pubkey_dsa.pem
IceSSL.KeyFile=privkey_dsa.pem
IceSSL.CertAuthFile=ca.pem
IceSSL.Password=password
IceSSL.Ciphers=DEFAULT:DSS
```

The `IceSSL.Ciphers` property adds support for DSS authentication to the plug-in's default set of ciphersuites. See Appendix C for more information on this property.

ADH Example

The following example uses ADH (the Anonymous Diffie-Hellman cipher). ADH is not a good choice in most cases because, as its name implies, there is no authentication of the communicating parties, and it is vulnerable to man-in-the-middle attacks. However, it still provides encryption of the session traffic and requires very little administration and therefore may be useful in certain situations. The configuration properties shown below demonstrate how to use ADH:

```
Ice.Plugin.IceSSL=IceSSL:createIceSSL
IceSSL.Ciphers=ADH
IceSSL.VerifyPeer=0
```

The `IceSSL.Ciphers` property enables support for ADH, which is disabled by default.

The `IceSSL.VerifyPeer` property changes the plug-in's default behavior with respect to certificate verification. Without this setting, IceSSL rejects a connection if the peer does not supply a certificate (as is the case with ADH).

See Appendix C for more information on these properties.

40.4.2 Java

IceSSL uses Java's native format for storing keys and certificates: the keystore. A keystore is represented as a file containing key pairs and associated certificates, and is usually administered using the **keytool** utility supplied with the Java runtime. Keystores serve two roles in Java's SSL architecture:

1. A keystore containing a key pair identifies the peer and is usually closely guarded.
2. A keystore containing public certificates represents the identities of trusted peers and can be freely shared. These keystores are also referred to as "truststores."

Java supports a pluggable architecture for keystore implementations in which a system property selects a particular implementation as the default keystore type. IceSSL uses the default keystore type unless otherwise specified.

A password is assigned to each key pair in a keystore, as well as to the keystore itself. IceSSL must be provided with the password for the key pair, but the keystore password is optional. If a keystore password is specified, it is used only to verify the keystore's integrity. IceSSL requires that all of the key pairs in a keystore have the same password.

Our first example shows the properties that are sufficient in many situations:

```
Ice.Plugin.IceSSL=IceSSL.PluginFactory
IceSSL.DefaultDir=/opt/certs
IceSSL.Keystore=keys.jks
IceSSL.Truststore=ca.jks
IceSSL.Password=password
```

The `IceSSL.DefaultDir` property is a convenient way to specify the default location of your keystore and truststore files. The `IceSSL.Password` property specifies the password of the key pair.

Note that it is a security risk to define a password in a plain text file, such as an Ice configuration file, because anyone who can gain read access to your configuration file can obtain your password. Section 40.6.1 describes a more secure way to configure the plug-in.

DSA Example

Java supports both RSA and DSA keys. No additional properties are necessary to use DSA:

```
Ice.Plugin.IceSSL=IceSSL.PluginFactory
IceSSL.DefaultDir=/opt/certs
IceSSL.Keystore=dsakeys.jks
IceSSL.Truststore=ca.jks
IceSSL.Password=password
```

ADH Example

The following example uses ADH (the Anonymous Diffie-Hellman cipher). ADH is not a good choice in most cases because, as its name implies, there is no authentication of the communicating parties, and it is vulnerable to man-in-the-middle attacks. However, it still provides encryption of the session traffic and requires very little administration and therefore may be useful in certain situations. The configuration properties shown below demonstrate how to use ADH:

```
Ice.Plugin.IceSSL=IceSSL.PluginFactory
IceSSL.DefaultDir=/opt/certs
IceSSL.Ciphers=NONE (DH_anon)
IceSSL.VerifyPeer=0
```

The `IceSSL.Ciphers` property enables support for ADH, which is disabled by default.

The `IceSSL.VerifyPeer` property changes the plug-in's default behavior with respect to certificate verification. Without this setting, IceSSL rejects a connection if the peer does not supply a certificate (as is the case with ADH).

See Appendix C for more information on these properties.

40.4.3 .NET 2.0

The Common Language Runtime (CLR) in .NET 2.0 uses certificate stores as the persistent repositories of certificates and keys. Furthermore, the CLR maintains two distinct sets of certificate stores, one for the current user and another for the local machine. Although it is possible to load a certificate and its corresponding

private key from a regular file, the CLR requires trusted CA certificates to reside in an appropriate certificate store.

Managing Certificates with the Microsoft Management Console

On Windows, you can use the Microsoft Management Console (MMC) to browse the contents of the various certificate stores. To start the console, run `MMC . EXE` from a command window, or choose Run from the Start menu and enter `MMC . EXE`.

Once the console is running, you need to install the Certificates “snap-in” by choosing Add/Remove Snap-in from the File menu. Click the Add button, choose Certificates in the popup window and click Add. If you wish to manage certificates for the current user, select My Current Account and click Finish. To manage certificates for the local computer, select Computer Account and click Next, then select Local Computer and click Finish.

When you have finished adding snap-ins, close the Add Standalone Snap-in window and click OK on the Add/Remove Snap-in window. Your Console Root window now contains a tree structure that you can expand to view the available certificate stores. If you have a certificate in a file that you want to add to a store, click on the desired store, then open the Action menu and select All Tasks/Import.

Using Certificate Files

Our first example demonstrates how to configure IceSSL with a file that contains the program’s certificate and key:

```
Ice.Plugin.IceSSL=icesslcs.dll:IceSSL.PluginFactory
IceSSL.DefaultDir=/opt/certs
IceSSL.CertFile=cert.pfx
IceSSL.Password=password
```

The `IceSSL.DefaultDir` property is a convenient way to specify the default location of your certificate file. This file must use the Personal Information Exchange (PFX, also known as PKCS#12) format and contain both a certificate and its corresponding private key. The `IceSSL.Password` property specifies the password used to secure the file.

Note that it is a security risk to define a password in a plain text file, such as an Ice configuration file, because anyone who can gain read access to your configuration file can obtain your password. More secure methods of configuring the plugin are described in the next section and in Section 40.6.1.

This configuration assumes that any trusted CA certificates necessary to authenticate the program’s peers are already installed in an appropriate certificate

store. You may also use a configuration property to automatically import a certificate from a file, as described in a subsequent section below.

Using Certificate Stores

If the program's certificate and private key are already installed in a certificate store, you can select it using the `IceSSL.FindCert` configuration property as shown in the following example:

```
Ice.Plugin.IceSSL=icesslcs.dll:IceSSL.PluginFactory
IceSSL.FindCert.LocalMachine.My=subject:"Quote Server"
```

An `IceSSL.FindCert` property executes a query in a particular certificate store and selects all of the certificates that match the given criteria. In the example above, the location of the certificate store is `LocalMachine`, and the store's name is `My`. When using MMC to browse the certificate stores, this specification is equivalent to the store "Personal" in the location "Certificates (Local Computer)."

The other legal value for the location component of the property name is `CurrentUser`. Table 40.1 shows the valid values for the store name component and their equivalents in MMC.

Table 40.1. Certificate store names.

Property Name	MMC Name
AddressBook	Other People
AuthRoot	Third-Party Root Certification Authorities
CertificateAuthority	Intermediate Certification Authorities
Disallowed	Untrusted Certificates
My	Personal
Root	Trusted Root Certification Authorities
TrustedPeople	Trusted People
TrustedPublisher	Trusted Publishers

The search criteria consists of *name:value* pairs that perform case-insensitive comparisons against the fields of each certificate in the specified store, and the special property value *** selects every certificate in the store. Typically, however, the criteria should select a single certificate. In a server, IceSSL must supply the CLR with the certificate that represents the server's identity; if a configuration matches several certificates, IceSSL chooses one (in an undefined manner) and logs a warning to notify you of the situation.

Selecting a certificate from a store is more secure than using a certificate file via the `IceSSL.CertFile` property because it is not necessary to specify a plain-text password. MMC prompts you for the password when initially importing a certificate into a store, so the password is not required when an application uses that certificate to identify itself.

For complete details about the syntax of the `IceSSL.FindCert` property, see its description in Appendix C.

Importing Certificates

IceSSL can be configured to import a certificate into a particular store. The Ice demos and test suites use this capability to ensure that the CA certificate is present, which avoids the need for a user to manually import the certificate using MMC before she could use the Ice sample programs and tests.

The `IceSSL.ImportCert` property uses the same format for its name as the `IceSSL.FindCert` property described above, in that the certificate store's location and name are part of the property name:

```
IceSSL.ImportCert.LocalMachine.AuthRoot=cacert.pem
```

The property's value is the name of a certificate file and an optional password. If a file is protected with a password, append the password to the property value using a semicolon as the separator. IceSSL uses the value of `IceSSL.DefaultDir` to complete the filename if necessary. The CLR accepts a number of encoding formats for the certificate, including PEM, DER and PFX.

The store name should be chosen with care. When installing a trusted CA certificate, you must install it into the `AuthRoot` or `Root` certificate stores for authentication to succeed. If you specify a store name other than those listed in Table 40.1, IceSSL creates a new store with the given name and adds the certificate to it. Once installed in the specified store, the application (or the user) is responsible for removing the certificate when it is no longer necessary.

40.4.4 Ciphersuites

A ciphersuite represents a particular combination of encryption, authentication and hashing algorithms. The IceSSL plug-ins for C++ and Java allow you to configure the ciphersuites that their underlying SSL engines are allowed to negotiate during handshaking with a peer. By default, IceSSL uses the underlying engine's default ciphersuites, but you can define a property to customize the list as we demonstrated earlier in this section with the ADH examples. Normally the default configuration is chosen to eliminate relatively insecure ciphersuites such as ADH, which is the reason it must be explicitly enabled.

Configuring Ciphersuites in C++

The value of the `IceSSL.Ciphers` property is given directly to the low-level OpenSSL library, on which IceSSL is based. Therefore, OpenSSL determines the allowable ciphersuites, which in turn depend on how the OpenSSL distribution was compiled. You can obtain a complete list of the supported ciphersuites using the `openssl ciphers` command:

```
$ openssl ciphers
```

This command will likely generate a long list. To simplify the selection process, OpenSSL supports several classes of ciphers, as shown in Table 40.2.

Table 40.2. Cipher classes.

Class	Description
ALL	All possible combinations.
ADH	Anonymous ciphers.
LOW	Low bit-strength ciphers.
EXP	Export-crippled ciphers.

Classes and ciphers can be excluded by prefixing them with an exclamation point. The special keyword `@STRENGTH` sorts the cipher list in order of their strength, so that SSL gives preference to the more secure ciphers when negotiating a cipher suite. The `@STRENGTH` keyword must be the last element in the list.

For example, here is a good value for the `cipherlist` attribute:

```
ALL:!ADH:!LOW:!EXP:!MD5:@STRENGTH
```

This value excludes the ciphers with low bit strength and known problems, and orders the remaining ciphers according to their strength.

Note that no warning is given if an unrecognized cipher is specified.

Configuring Ciphersuites in Java

IceSSL for Java interprets the value of `IceSSL.Ciphers` as a sequence of expressions that filter the selected ciphersuites using name and pattern matching. If the property is not defined, the Java security provider's default ciphersuites are used. Table 40.3 defines the valid expressions that may appear in the property value.

Table 40.3. Ciphersuite filter expressions.

Expression	Description
NONE	Disables all ciphersuites. If specified, it must appear first.
ALL	Enables all supported ciphersuites. If specified, it must appear first. This expression should be used with caution, as it may enable low-security ciphersuites
<i>NAME</i>	Enables the ciphersuite matching the given name.
<i>!NAME</i>	Disables the ciphersuite matching the given name.
<i>(EXP)</i>	Enables ciphersuites whose names contain the regular expression <i>EXP</i> .
<i>!(EXP)</i>	Disables ciphersuites whose names contain the regular expression <i>EXP</i> .

To determine the set of enabled ciphersuites, the plug-in begins with a list of ciphersuite names containing the default set as determined by the security provider. The expressions in the property value add and remove ciphersuites from this list and are evaluated in the order of appearance. For example, consider the following property definition:

```
IceSSL.Ciphers=NONE (RSA.*AES) !(EXPORT)
```

The expressions in this property have the following effects:

- NONE clears the list of enabled ciphersuites.

- `(RSA.*AES)` is a regular expression that enables ciphersuites whose names contain the string “RSA” followed by “AES”, meaning ciphersuites using RSA authentication and AES encryption.
- `!(EXPORT)` is a regular expression that disables any of the selected ciphersuites whose names contain the string “EXPORT”, meaning ciphersuites having export-quality strength.

As another example, this property adds anonymous Diffie-Hellman to the default set of ciphersuites and disables export ciphersuites:

```
IceSSL.Client.Ciphers=(DH_anon) !(EXPORT)
```

Finally, this example selects only one ciphersuite:

```
IceSSL.Client.Ciphers=NONE SSL_RSA_WITH_RC4_128_SHA
```

40.4.5 Trust

As described in Section 40.2.2, declaring that you trust a certificate authority implies that you trust any peer whose certificate was signed directly or indirectly by that certificate authority. It is necessary to use this broad definition of trust in some applications, such as a public Web server. In more controlled environments, it is a good idea to restrict access as much as possible, and IceSSL provides a number of ways for you to do that.

Trusted Peers

After the low-level SSL engine has completed its authentication process, IceSSL can be configured to take additional steps to verify that a peer should be trusted. The `IceSSL.TrustOnly` family of properties defines a collection of filters that IceSSL applies to the distinguished name of a peer’s certificate in order to determine whether to allow the connection to proceed. IceSSL permits the connection if the peer’s distinguished name matches any of the filters, otherwise the connection is rejected.

A distinguished name uniquely identifies a person or entity and is generally represented in the following textual form:

```
C=US, ST=Florida, L=Palm Beach Gardens, O="ZeroC, Inc.",  
OU=Servers, CN=Quote Server
```

Suppose we are configuring a client to communicate with the server whose distinguished name is shown above. If we know that the client is allowed to communicate only with this server, we can enforce this rule using the following property:

```
IceSSL.TrustOnly=O="ZeroC, Inc.", OU=Servers, CN=Quote Server
```

With this property in place, IceSSL allows a connection to proceed only if the distinguished name in the server's certificate matches this filter. The property may contain multiple filters, separate by semicolons, if the client needs to communicate with more than one server. Additional variations of the property are also supported, as described in Appendix C.

If the `IceSSL.TrustOnly` properties do not provide the selectivity you require, the next step is to install a custom certificate verifier (see Section 40.5).

Verification Depth

In order to authenticate a peer, SSL obtains the peer's certificate chain, which includes the peer's certificate as well as that of the root CA. SSL verifies that each certificate in the chain is valid, but there still remains a subtle security risk. Suppose that we have identified a trusted root CA (via its certificate), and a peer has supplied a valid certificate chain signed by our trusted root CA. It is possible for an attacker to obtain a special signing certificate that is signed by our root CA and therefore trusted implicitly. The attacker can use this certificate to sign fraudulent certificates with the goal of masquerading as a trusted peer, presumably for some nefarious purpose.

We could use the `IceSSL.TrustOnly` properties described above in an attempt to defend against such an attack. However, the attacker could easily manufacture a certificate containing a distinguished name that satisfies the trust properties.

If you know that all trusted peers present certificate chains of a certain length, set the property `IceSSL.VerifyDepthMax` so that IceSSL automatically rejects longer chains. The default value of this property is two, therefore you may need to set it to a larger value if you expect peers to present longer chains.

In situations where you cannot make assumptions about the length of a peer's certificate chain, yet you still want to examine the chain before allowing the connection, you should install a custom certificate verifier (see Section 40.5).

40.4.6 Diagnostics

You can use two configuration properties to obtain more information about the plug-in's activities. Setting `IceSSL.Trace.Security=1` enables the plug-in's diagnostic output, which includes a variety of messages regarding events such as ciphersuite selection, peer verification and trust evaluation. The other property, `Ice.Trace.Network`, determines how much information is logged about

network events such as connections and packets. Note that the output generated by `Ice.Trace.Network` also includes other transports such as TCP and UDP.

System Logging in Java

In Java, you can use a system property that displays a great deal of information about SSL certificates and connections, including the ciphersuite that is selected for use by each connection. For example, the following command sets the system property that activates the diagnostics:

```
$ java -Djavax.net.debug=ssl MyProgram
```

System Logging in .NET

Enabling additional tracing output in .NET requires the creation of an XML file such as the one shown below:

```
<?xml version="1.0" encoding="UTF-8" ?>
<configuration>
  <system.diagnostics>
    <trace autoflush="true"/>
    <sources>
      <source name="System.Net">
        <listeners>
          <add name="System.Net"/>
        </listeners>
      </source>
      <source name="System.Net.Sockets">
        <listeners>
          <add name="System.Net"/>
        </listeners>
      </source>
      <source name="System.Net.Cache">
        <listeners>
          <add name="System.Net"/>
        </listeners>
      </source>
    </sources>
    <sharedListeners>
      <add
        name="System.Net"
        type="System.Diagnostics.TextWriterTraceListener"
        initializeData="trace.txt"
      />
    </sharedListeners>
  </system.diagnostics>
</configuration>
```

```

        <add name="System.Net" value="Verbose"/>
        <add name="System.Net.Sockets" value="Verbose"/>

        <add name="System.Net.Cache" value="Verbose"/>
    </switches>
</system.diagnostics>
</configuration>

```

In this example, the output is stored in the file `trace.txt`. To activate tracing, give the XML file the same name as your executable with a `.config` extension as in `server.exe.config`, and place it in the same directory as the executable.

40.5 Programming with IceSSL

The configuration properties described in Section 40.4 are flexible enough to satisfy the requirements of many applications, and IceSSL supports a public API that offers even more functionality for those applications that need it.

40.5.1 C++

This section describes the C++ API for the IceSSL plug-in.

The Plugin Interface

Applications can interact directly with the IceSSL plug-in using the native C++ class `IceSSL::Plugin`. A reference to a `Plugin` object must be obtained from the communicator in which the plug-in is installed:

```

Ice::CommunicatorPtr communicator = // ...
Ice::PluginManagerPtr pluginMgr =
    communicator->getPluginManager();
Ice::PluginPtr plugin = pluginMgr->getPlugin("IceSSL");
IceSSL::PluginPtr sslPlugin =
    IceSSL::PluginPtr::dynamicCast(plugin);

```

The `Plugin` class supports the following methods:

```

namespace IceSSL
{
class Plugin : public Ice::Plugin
{
public:

```

```

virtual void setContext(SSL_CTX*) = 0;
virtual SSL_CTX* getContext() = 0;

virtual void setCertificateVerifier(
    const CertificateVerifierPtr&) = 0;

virtual void setPasswordPrompt(
    const PasswordPromptPtr&) = 0;
};
typedef IceUtil::Handle<Plugin> PluginPtr;
}

```

The `setContext` and `getContext` methods are rarely used in practice; see Section 40.6 for more information. The `setCertificateVerifier` method installs a custom certificate verifier object that the plugin invokes for each new connection. The `setPasswordPrompt` method provides an alternate way to supply IceSSL with passwords, as discussed in Section 40.6.

Installing a Certificate Verifier

A new connection undergoes a series of verification steps before an application is allowed to use it. The low-level SSL engine executes the validation procedures described in Section 40.2.2. Assuming the certificate chain is successfully validated, IceSSL performs additional verification as directed by its configuration properties (see Section 40.4.5). Finally, if a certificate verifier is installed, IceSSL invokes it to provide the application with an opportunity to decide whether to allow the connection to proceed.

The `CertificateVerifier` interface has only one method:

```

namespace IceSSL
{
class CertificateVerifier : public IceUtil::Shared
{
public:

    virtual bool verify(const ConnectionInfo&) = 0;
};
typedef IceUtil::Handle<CertificateVerifier>
    CertificateVerifierPtr;
}

```

IceSSL rejects the connection if `verify` returns `false`, and allows it to proceed if the method returns `true`. The `verify` method receives a `ConnectionInfo` object that describes the connection's attributes:

```

namespace IceSSL
{
struct ConnectionInfo
{
    std::vector<CertificatePtr> certs;
    std::string cipher;
    struct sockaddr_in localAddr;
    struct sockaddr_in remoteAddr;
    bool incoming;
    std::string adapterName;
};
}

```

The `certs` member is a vector of certificates representing the peer's certificate chain. The vector is structured so that the first element is the peer's certificate, followed by its signing certificates in the order they appear in the chain, with the root CA certificate as the last element. The vector is empty if the peer did not present a certificate chain.

The `cipher` member is a description of the ciphersuite that SSL negotiated for this connection. The local and remote address information is provided in `localAddr` and `remoteAddr`, respectively. The `incoming` member indicates whether the connection is inbound (a server connection) or outbound (a client connection). Finally, if `incoming` is `true`, the `adapterName` member supplies the name of the object adapter that hosts the endpoint.

The following class is a simple implementation of a certificate verifier:

```

class Verifier : public IceSSL::CertificateVerifier
{
public:

    bool verify(const IceSSL::ConnectionInfo& info)
    {
        if(!info.certs.empty())
        {
            string dn = info.certs[0].getIssuerDN();
            transform(dn.begin(), dn.end(), dn.begin(),
                ::tolower);
            if(dn.find("zeroc") != string::npos)
            {
                return true;
            }
        }
    }
}

```

```

    }
    return false;
}
}

```

In this example, the verifier rejects the connection unless the string `zeroc` is present in the issuer's distinguished name of the peer's certificate. In a more realistic implementation, the application is likely to perform detailed inspection of the certificate chain.

Installing the verifier is a simple matter of calling `setCertificateVerifier` on the plugin interface:

```

IceSSL::PluginPtr sslPlugin = // ...
sslPlugin->setCertificateVerifier(new Verifier);

```

You should install the verifier before any SSL connections are established.

See Section 40.6.2 for more information on installing a certificate verifier.

Obtaining Connection Information

You can obtain information about any SSL connection using the `getConnectionInfo` function:

```

namespace IceSSL
{
    ConnectionInfo getConnectionInfo(const Ice::ConnectionPtr&);
}

```

The function throws `IceSSL::ConnectionInvalidException` if its argument does not represent an SSL connection.

For more information on connections, see Chapter 35.

Certificates

The `ConnectionInfo` class contains a vector of `Certificate` objects representing the peer's certificate chain. `Certificate` is a reference-counted convenience class that hides the complexity of the underlying OpenSSL API. Its methods are inspired by the Java class `X509Certificate`:

```

namespace IceSSL
{
    class Certificate : public IceUtil::Shared
    {
    public:

        Certificate(X509*);
    };
}

```



```
static CertificatePtr load(const string&);
static CertificatePtr decode(const string&);

bool operator==(const Certificate&) const;
bool operator!=(const Certificate&) const;

PublicKeyPtr getPublicKey() const;

bool verify(const PublicKeyPtr&) const;

string encode() const;

bool checkValidity() const;
bool checkValidity(const IceUtil::Time&) const;

IceUtil::Time getNotAfter() const;
IceUtil::Time getNotBefore() const;

string getSerialNumber() const;

DistinguishedName getIssuerDN() const;
vector<pair<int, string> > getIssuerAlternativeNames();

DistinguishedName getSubjectDN() const;
vector<pair<int, string> > getSubjectAlternativeNames();

int getVersion() const;

string toString() const;

X509* getCert() const;
};
typedef IceUtil::Handle<Certificate> CertificatePtr;
}
```

The more commonly-used methods are described below; refer to the documentation in `IceSSL/Plugin.h` for information on the methods that are not covered.

The static method `load` creates a certificate from the contents of a PEM-encoded file. If an error occurs, the function raises `IceSSL::CertificateReadException`; the `reason` member provides a description of the problem.

Use `decode` to obtain a certificate from a PEM-encoded string representing a certificate. The caller must be prepared to catch `IceSSL::CertificateEn-`

`codingException` if `decode` fails; the `reason` member provides a description of the problem.

The `encode` method creates a PEM-encoded string that represents the certificate. The return value can later be passed to `decode` to recreate the certificate.

The `checkValidity` methods determine whether the certificate is valid. The overloading with no arguments returns `true` if the certificate is valid at the current time; the other overloading accepts an `IceUtil::Time` object and returns `true` if the certificate is valid at the given time. See Section 30.7 for more information on `IceUtil::Time`.

The `getNotAfter` and `getNotBefore` methods return instances of `IceUtil::Time` that define the certificate's valid period.

The methods `getIssuerDN` and `getSubjectDN` supply the distinguished names of the certificate's issuer (i.e., the CA that signed the certificate) and subject (i.e., the person or entity to which the certificate was issued). The methods return instances of the class `IceSSL::DistinguishedName`, another convenience class that is described in the next section.

Finally, the `toString` method returns a human-readable string describing the certificate.

Distinguished Names

X.509 certificates use a distinguished name to identify a person or entity. The name is an ordered sequence of relative distinguished names that supply values for fields such as common name, organization, state, and country. Distinguished names are commonly displayed in stringified form according to the rules specified by RFC 2253, as shown in the following example:

```
C=US, ST=Florida, L=Palm Beach Gardens, O="ZeroC, Inc.",
OU=Servers, CN=Quote Server
```

`DistinguishedName` is a convenience class provided by `IceSSL` to simplify the tasks of parsing, formatting and comparing distinguished names.

```
namespace IceSSL
{
class DistinguishedName
{
public:

    DistinguishedName(const std::string&);
    DistinguishedName(
        const std::list<std::pair<std::string, std::string> >&);
```

```
bool operator==(const DistinguishedName&) const;
bool operator!=(const DistinguishedName&) const;
bool operator<(const DistinguishedName&) const;

bool match(const DistinguishedName&) const;

operator std::string() const;
};
}
```

The first overloaded constructor accepts a string argument representing a distinguished name encoded using the rules set forth in RFC 2253. The new `DistinguishedName` instance preserves the order of the relative distinguished names in the string. The caller must be prepared to catch `IceSSL::ParseException` if an error occurs during parsing.

The second overloaded constructor requires a list of type-value pairs representing the relative distinguished names. The new `DistinguishedName` instance preserves the order of the relative distinguished names in the list.

The overloaded operator functions `operator==`, `operator!=`, and `operator<` perform an exact match of distinguished names in which the order of the relative distinguished names is important. For two distinguished names to be equal, they must have the same relative distinguished names in the same order.

The `match` function performs a partial comparison that does not consider the order of relative distinguished names. If `N1` and `N2` are instances of `DistinguishedName`, `N1.match(N2)` returns true if all of the relative distinguished names in `N2` are present in `N1`.

Finally, the string conversion operator encodes the distinguished name in the format described by RFC 2253.

40.5.2 Java

This section describes the Java API for the IceSSL plug-in.

The Plugin Interface

Applications can interact directly with the IceSSL plug-in using the native Java interface `IceSSL.Plugin`. A reference to a `Plugin` object must be obtained from the communicator in which the plug-in is installed:

```
Ice.Communicator comm = // ...
Ice.PluginManager pluginMgr = comm.getPluginManager();
Ice.Plugin plugin = pluginMgr.getPlugin("IceSSL");
IceSSL.Plugin sslPlugin = (IceSSL.Plugin)plugin;
```

The Plugin interface supports the following methods:

```
package IceSSL;

public interface Plugin extends Ice.Plugin
{
    void setContext(javax.net.ssl.SSLContext context);
    javax.net.ssl.SSLContext getContext();

    void setCertificateVerifier(CertificateVerifier verifier);
}
```

The `setContext` and `getContext` methods are rarely used in practice; see Section 40.6 for more information. The `setCertificateVerifier` method installs a custom certificate verifier object that the plugin invokes for each new connection.

Installing a Certificate Verifier

A new connection undergoes a series of verification steps before an application is allowed to use it. The low-level SSL engine executes the validation procedures described in Section 40.2.2. Assuming the certificate chain is successfully validated, IceSSL performs additional verification as directed by its configuration properties (see Section 40.4.5). Finally, if a certificate verifier is installed, IceSSL invokes it to provide the application with an opportunity to decide whether to allow the connection to proceed.

The `CertificateVerifier` interface has only one method:

```
package IceSSL;

public interface CertificateVerifier
{
    boolean verify(ConnectionInfo info);
}
```

IceSSL rejects the connection if `verify` returns `false`, and allows it to proceed if the method returns `true`. The `verify` method receives a `ConnectionInfo` object that describes the connection's attributes:

```
package IceSSL;

public class ConnectionInfo
{
    public java.security.cert.Certificate[] certs;
    public String cipher;
    public java.net.InetSocketAddress localAddr;
    public java.net.InetSocketAddress remoteAddr;
    boolean incoming;
    String adapterName;
}
```

The `certs` member is an array of certificates representing the peer's certificate chain. The array is structured so that the first element is the peer's certificate, followed by its signing certificates in the order they appear in the chain, with the root CA certificate as the last element. This member is null if the peer did not present a certificate chain.

The `cipher` member is a description of the ciphersuite that SSL negotiated for this connection. The local and remote address information is provided in `localAddr` and `remoteAddr`, respectively. The `incoming` member indicates whether the connection is inbound (a server connection) or outbound (a client connection). Finally, if `incoming` is `true`, the `adapterName` member supplies the name of the object adapter that hosts the endpoint.

The following class is a simple implementation of a certificate verifier:

```
import java.security.cert.X509Certificate;
import javax.security.auth.x500.X500Principal;

class Verifier implements IceSSL.CertificateVerifier
{
    public boolean
    verify(IceSSL.ConnectionInfo info)
    {
        if(info.certs != null)
        {
            X509Certificate cert = (X509Certificate)info.certs[0];
            X500Principal p = cert.getIssuerX500Principal();
            if(p.getName().toLowerCase().indexOf("zeroc") != -1)
            {
                return true;
            }
        }
    }
}
```

```
        }
        return false;
    }
}
```

In this example, the verifier rejects the connection unless the string `zeroc` is present in the issuer's distinguished name of the peer's certificate. In a more realistic implementation, the application is likely to perform detailed inspection of the certificate chain.

Installing the verifier is a simple matter of calling `setCertificateVerifier` on the plugin interface:

```
IceSSL.Plugin sslPlugin = // ...
sslPlugin.setCertificateVerifier(new Verifier());
```

You should install the verifier before any SSL connections are established.

See Section 40.6.2 for more information on installing a certificate verifier.

Obtaining Connection Information

You can obtain information about any SSL connection using the `getConnectionInfo` function:

```
package IceSSL;

public final class Util
{
    public static ConnectionInfo
        getConnectionInfo(Ice.Connection connection);

    // ...
}
```

The function throws `IceSSL.ConnectionInvalidException` if its argument does not represent an SSL connection.

For more information on connections, see Chapter 35.

Converting Certificates

Java does not provide a simple way to create a certificate object from a PEM-encoded string, therefore IceSSL offers the following convenience method:

```
package IceSSL;

public final class Util
{
    // ...
}
```

```

        public static java.security.cert.X509Certificate
        createCertificate(String certPEM)
            throws java.security.cert.CertificateException;
    }

```

Given a string in the PEM format, `createCertificate` returns the equivalent `X509Certificate` object.

40.5.3 C#

This section describes the C# API for the IceSSL plug-in.

The Plugin Interface

Applications can interact directly with the IceSSL plug-in using the native C# interface `IceSSL.Plugin`. A reference to a `Plugin` object must be obtained from the communicator in which the plug-in is installed:

```

Ice.Communicator comm = // ...
Ice.PluginManager pluginMgr = comm.getPluginManager();
Ice.Plugin plugin = pluginMgr.getPlugin("IceSSL");
IceSSL.Plugin sslPlugin = (IceSSL.Plugin)plugin;

```

The `Plugin` interface supports the following methods:

```

namespace IceSSL
{
    using System.Security.Cryptography.X509Certificates;

    abstract public class Plugin : Ice.LocalObjectImpl, Ice.Plugin
    {
        abstract public void
        setCertificates(X509Certificate2Collection certs);

        abstract public void
        setCertificateVerifier(CertificateVerifier verifier);
    }
}

```

The `setCertificates` method is rarely used in practice; see Section 40.6 for more information. The `setCertificateVerifier` method installs a custom certificate verifier object that the plugin invokes for each new connection.

Installing a Certificate Verifier

A new connection undergoes a series of verification steps before an application is allowed to use it. The low-level SSL engine executes the validation procedures described in Section 40.2.2. Assuming the certificate chain is successfully validated, IceSSL performs additional verification as directed by its configuration properties (see Section 40.4.5). Finally, if a certificate verifier is installed, IceSSL invokes it to provide the application with an opportunity to decide whether to allow the connection to proceed.

The `CertificateVerifier` interface has only one method:

```
namespace IceSSL
{
    public interface CertificateVerifier
    {
        bool verify(ConnectionInfo info);
    }
}
```

IceSSL rejects the connection if `verify` returns `false`, and allows it to proceed if the method returns `true`. The `verify` method receives a `ConnectionInfo` object that describes the connection's attributes:

```
namespace IceSSL
{
    using System.Security.Cryptography.X509Certificates;

    public sealed class ConnectionInfo
    {
        public X509Certificate2[] certs;
        public string cipher;
        public System.Net.IPEndPoint localAddr;
        public System.Net.IPEndPoint remoteAddr;
        public bool incoming;
        public string adapterName;
    }
}
```

The `certs` member is an array of certificates representing the peer's certificate chain. The array is structured so that the first element is the peer's certificate, followed by its signing certificates in the order they appear in the chain, with the root CA certificate as the last element. This member is null if the peer did not present a certificate chain.

The `cipher` member is a description of the ciphersuite that SSL negotiated for this connection. The local and remote address information is provided in

localAddr and remoteAddr, respectively. The incoming member indicates whether the connection is inbound (a server connection) or outbound (a client connection). Finally, if incoming is true, the adapterName member supplies the name of the object adapter that hosts the endpoint.

The following class is a simple implementation of a certificate verifier:

```
using System.Security.Cryptography.X509Certificates;

class Verifier : IceSSL.CertificateVerifier
{
    public boolean
    verify(IceSSL.ConnectionInfo info)
    {
        if(info.certs != null)
        {
            X500DistinguishedName dn = info.certs[0].IssuerName;
            if(dn.Name.ToLower().Contains("zeroc"))
            {
                return true;
            }
        }
        return false;
    }
}
```

In this example, the verifier rejects the connection unless the string zeroc is present in the issuer's distinguished name of the peer's certificate. In a more realistic implementation, the application is likely to perform detailed inspection of the certificate chain.

Installing the verifier is a simple matter of calling setCertificateVerifier on the plugin interface:

```
IceSSL.Plugin sslPlugin = // ...
sslPlugin.setCertificateVerifier(new Verifier());
```

You should install the verifier before any SSL connections are established.

See Section 40.6.2 for more information on installing a certificate verifier.

Obtaining Connection Information

You can obtain information about any SSL connection using the getConnectionInfo function:

```
namespace IceSSL
{
    public sealed class Util
    {
        // ...

        public static ConnectionInfo
            getConnectionInfo(Ice.Connection connection);
    }
}
```

The function throws `IceSSL.ConnectionInvalidException` if its argument does not represent an SSL connection.

For more information on connections, see Chapter 35.

Converting Certificates

IceSSL offers the following convenience method to create a certificate object from a PEM-encoded string:

```
namespace IceSSL
{
    using System.Security.Cryptography.X509Certificates;

    public sealed class Util
    {
        // ...

        public static X509Certificate2
            createCertificate(string certPEM);
    }
}
```

Given a string in the PEM format, `createCertificate` returns the equivalent `X509Certificate2` object.

40.5.4 Visual Basic

This section describes the Visual Basic API for the IceSSL plug-in.

The Plugin Interface

Applications can interact directly with the IceSSL plug-in using the native Visual Basic interface `IceSSL.Plugin`. A reference to a `Plugin` object must be obtained from the communicator in which the plug-in is installed:

```
Dim comm As Ice.Communicator = // ...
Dim pluginMgr As Ice.PluginManager = comm.getPluginManager()
Dim plugin As Ice.Plugin = pluginMgr.getPlugin("IceSSL")
Dim sslPlugin As IceSSL.Plugin = (IceSSL.Plugin)plugin
```

The Plugin interface supports the following methods:

```
Namespace IceSSL

Imports System.Security.Cryptography.X509Certificates

Public Interface Plugin Inherits Ice.Plugin

    Public MustOverride Sub
        setCertificates(ByVal certs As X509Certificate2Collection)

    Public MustOverride Sub
        setCertificateVerifier(
            ByVal verifier As CertificateVerifier)

End Class

End Namespace
```

The `setCertificates` method is rarely used in practice; see Section 40.6 for more information. The `setCertificateVerifier` method installs a custom certificate verifier object that the plugin invokes for each new connection.

Installing a Certificate Verifier

A new connection undergoes a series of verification steps before an application is allowed to use it. The low-level SSL engine executes the validation procedures required by the protocol specification, which includes checking the validity of the peer's certificate chain. If this step completes successfully, IceSSL performs additional verification as directed by its configuration properties (see Section 40.4.5). Finally, if a certificate verifier is installed, IceSSL invokes it to provide the application with an opportunity to decide whether to allow the connection to proceed.

The `CertificateVerifier` interface has only one method:

```
Namespace IceSSL

Public Interface CertificateVerifier

    Function verify(ByVal info As ConnectionInfo) As Boolean

End Interface
```

```
End Interface
```

```
End Namespace
```

IceSSL rejects the connection if `verify` returns `False`, and allows it to proceed if the method returns `True`. The `verify` method receives a `ConnectionInfo` object that describes the connection's attributes:

```
Namespace IceSSL
```

```
Imports System.Security.Cryptography.X509Certificates
```

```
Public NotInheritable Class ConnectionInfo
    Public certs As X509Certificate2()
    Public cipher As String
    Public localAddr As System.Net.IPEndPoint
    Public remoteAddr As System.Net.IPEndPoint
    Public incoming As Boolean
    Public adapterName As String
End Class
```

```
End Namespace
```

The `certs` member is an array of certificates representing the peer's certificate chain. This member is `Nothing` if the peer did not present a certificate chain, otherwise the first element of the array is the peer's certificate.

The `cipher` member is a description of the ciphersuite that SSL negotiated for this connection. The local and remote address information is provided in `localAddr` and `remoteAddr`, respectively. The `incoming` member indicates whether the connection is inbound (a server connection) or outbound (a client connection). Finally, if `incoming` is `True`, the `adapterName` member supplies the name of the object adapter that received the connection.

The following class is a simple implementation of a certificate verifier:

```
Imports System.Security.Cryptography.X509Certificates
```

```
Class Verifier Implements IceSSL.CertificateVerifier
```

```
    Public Function
    verify(ByVal info As IceSSL.ConnectionInfo) As Boolean
        Implements IceSSL.CertificateVerifier.verify
```

```
        If info.certs <> Nothing
            Dim dn As X500DistinguishedName =
```

```

        info.certs(0).IssuerName
    If dn.Name.ToLower().Contains("zeroc")
        Return True
    End If
End If
Return False

End Function

End Class

```

In this example, the verifier rejects the connection unless the string `zeroc` is present in the issuer's distinguished name of the peer's certificate. In a more realistic implementation, the application is likely to perform detailed inspection of the certificate chain.

Installing the verifier is a simple matter of calling `setCertificateVerifier` on the plugin interface:

```

Dim sslPlugin As IceSSL.Plugin = // ...
sslPlugin.setCertificateVerifier(New Verifier())

```

You should install the verifier before any SSL connections are established.

See Section 40.6.2 for more information on installing a certificate verifier.

Obtaining Connection Information

You can obtain information about any SSL connection using the `getConnectionInfo` function:

```

Namespace IceSSL

Public NotInheritable Class Util

    Public Shared Function
    getConnectionInfo(connection As Ice.Connection)
        As ConnectionInfo

End Class

End Namespace

```

The function throws `IceSSL.ConnectionInvalidException` if its argument does not represent an SSL connection.

For more information on connections, see Chapter 35.

Converting Certificates

IceSSL offers the following convenience method to create a certificate object from a PEM-encoded string:

```
Namespace IceSSL

Imports System.Security.Cryptography.X509Certificates

Public NotInheritable Class Util

    Public Shared Function
        createCertificate(certPEM As String)
            As X509Certificate2

End Class

End Namespace
```

Given a string in the PEM format, `createCertificate` returns the equivalent `X509Certificate2` object.

40.6 Advanced Topics

This section discusses some additional capabilities of the IceSSL plug-in.

40.6.1 Passwords

IceSSL may need to obtain a password if it loads a file that contains secure data, such as an encrypted private key. Section 40.4 showed how an application can supply a plain-text password in a configuration property and mentioned that doing so is a potential security risk. For example, if you define the property on the application's command-line, it may be possible for other users on the same host to see the password simply by obtaining a list of active processes. If you define the property in a configuration file, the password is only as secure as the file in which it is defined.

In highly secure environments where access to a host is tightly restricted, a password can safely be supplied as a plain-text configuration property, or the need for the password can be eliminated altogether by using unsecured key files.

In situations where password security is a concern, the application generally needs to take additional action.

Dynamic Properties

A common technique is to prompt the user for a password and transfer the user's input to a configuration property that the application defines dynamically, as shown below:

```
// C++
string password = // ...
Ice::InitializationData initData;
initData.properties = Ice::createProperties(argc, argv);
initData.properties->setProperty("IceSSL.Password", password);
Ice::CommunicatorPtr comm = Ice::initialize(initData);
```

The password must be present in the property set before the communicator is initialized, since IceSSL needs the password during its initialization, and the communicator initializes plug-ins automatically by default.

Password Prompts in C++

If a password is required but the application has not configured one, IceSSL prompts the user at the terminal during the plug-in's initialization. This behavior is not suitable for some types of applications, such as a program that runs automatically at system startup as a Unix daemon or Windows service (see Section 8.3.2).

A terminal prompt is equally undesirable for graphical applications, which would generally prefer to prompt the user in an application window. The dynamic property technique described in the previous section is usually appropriate in this situation.

If your application must supply a password, and you do not want to use a configuration property or a terminal prompt, your remaining option is to install a `PasswordPrompt` object in the plug-in using the `setPasswordPrompt` method shown in Section 40.5.1. The `PasswordPrompt` class has the following definition:

```
namespace IceSSL
{
class PasswordPrompt : public IceUtil::Shared
{
public:

    virtual std::string getPassword() = 0;
};
typedef IceUtil::Handle<PasswordPrompt> PasswordPromptPtr;
}
```

IceSSL invokes `getPassword` on the object when a password is required. If the object returns an incorrect password, IceSSL tries again, up to the limit defined by the `IceSSL.PasswordRetryMax` property (see Appendix C).

Note that you must delay the initialization of the IceSSL plug-in until after the `PasswordPrompt` object is installed. To illustrate this point, consider the following example:

```
Ice::CommunicatorPtr communicator = // ...
Ice::PluginManagerPtr pluginMgr =
    communicator->getPluginManager();
Ice::PluginPtr plugin = pluginMgr->getPlugin("IceSSL");
IceSSL::PluginPtr sslPlugin =
    IceSSL::PluginPtr::dynamicCast(plugin);
sslPlugin->setPasswordPrompt(new Prompt); // OOPS!
```

This code is incorrect because the `PasswordPrompt` object is installed too late: the communicator is already initialized, which means IceSSL has already attempted to load the file that required a password.

The correct approach is to define the following configuration property:

```
Ice.InitPlugins=0
```

This setting causes the communicator to install, but not initialize, its configured plug-ins. The application becomes responsible for initializing the plug-ins, as shown below:

```
Ice::CommunicatorPtr communicator = // ...
Ice::PluginManagerPtr pluginMgr =
    communicator->getPluginManager();
Ice::PluginPtr plugin = pluginMgr->getPlugin("IceSSL");
IceSSL::PluginPtr sslPlugin =
    IceSSL::PluginPtr::dynamicCast(plugin);
sslPlugin->setPasswordPrompt(new Prompt);
pluginMgr->initializePlugins();
```

We assume the communicator was initialized with `Ice.InitPlugins=0`. After installing the `PasswordPrompt` object, the application invokes `initializePlugins` on the plugin manager to complete the plug-in initialization process.

Manual Configuration

The `Plugin` interface described in Section 40.5 supports a method in each of the supported language mappings that provides an application with more control over the plug-in's configuration.

In C++ and Java, an application can call the `setContext` method to supply a pre-configured “context” object used by the underlying SSL engines. In .NET 2.0, the `setCertificates` method accepts a collection of certificates that the plug-in should use. In all cases, using one of these methods causes IceSSL to ignore (at a minimum) the configuration properties related to certificates and keys. The application is responsible for accumulating its certificates and keys, and must also deal with any password requirements.

Describing the use of these plug-in methods in detail is outside the scope of this book, however it is important to understand their prerequisites. In particular, the application needs to have the communicator load the plug-in but not actually initialize it until after the application has had a chance to interact directly with it. (The previous section showed one example of this technique.) The application must define the following configuration property:

```
Ice.InitPlugins=0
```

With this setting, the application becomes responsible for completing the plug-in initialization process by invoking `initializePlugins` on the `PluginManager`. The C# example below demonstrates the proper steps:

```
// C#
Ice.Communicator comm = // ...
Ice.PluginManager pluginMgr = comm.getPluginManager();
Ice.Plugin plugin = pluginMgr.getPlugin("IceSSL");
IceSSL.Plugin sslPlugin = (IceSSL.Plugin)plugin;
X509Certificate2Collection certs = // ...
sslPlugin.setCertificates(certs);
pluginMgr.initializePlugins();
```

40.6.2 Custom Plug-ins

The Ice plug-in facility is not restricted to protocol implementations. Ice only requires that a plug-in implement the `Ice::Plugin` interface and support the language-specific mechanism for dynamic loading.

The customization options of the IceSSL plug-in make it possible for you to install an application-specific implementation of a certificate verifier in an existing program. For example, you could install a custom certificate verifier in a Glacier2 router without the need to modify Glacier2’s source code or rebuild the executable. You would have to write a C++ plug-in to accomplish this, since Glacier2 is written in C++. In short, your plug-in must interact with the IceSSL plug-in and install a certificate verifier.

For this technique to work, it is important that the plug-ins be loaded in a particular order. Specifically, the IceSSL plug-in must be loaded first, followed by the certificate verifier plug-in. By default, Ice loads plug-ins in an undefined order, but you can use the property `Ice.PluginLoadOrder` to specify a particular order.

As an example, let's write a plug-in that installs the simple certificate verifier from Section 40.5.1. Here is the definition of our plug-in class:

```
class VerifierPlugin : public Ice::Plugin
{
public:
    VerifierPlugin(const Ice::CommunicatorPtr & comm) :
        _comm(comm)
    {
    }

    virtual void initialize()
    {
        Ice::PluginManagerPtr pluginMgr =
            _comm->getPluginManager();
        Ice::PluginPtr plugin = pluginMgr->getPlugin("IceSSL");
        IceSSL::PluginPtr sslPlugin =
            IceSSL::PluginPtr::dynamicCast(plugin);
        sslPlugin->setCertificateVerifier(new Verifier);
    }

    virtual void destroy()
    {
    }

private:
    Ice::CommunicatorPtr _comm;
};
```

The class implements the two operations in the `Plugin` interface, `initialize` and `destroy`. The code in `initialize` installs the certificate verifier object, while nothing needs to be done in `destroy`.

The next step is to write the plug-in's registration function, which the communicator invokes to obtain an instance of the plug-in:

```
extern "C"
{

Ice::Plugin*
createVerifierPlugin(
```

```
    const Ice::CommunicatorPtr & communicator,  
    const string & name,  
    const Ice::StringSeq & args)  
{  
    return new VerifierPlugin(communicator);  
}  
  
}
```

We can give the function any name; in this example, we chose `createVerifierPlugin`.

Finally, to install the plug-in we need to define the following properties:

```
Ice.PluginLoadOrder=IceSSL,Verifier  
Ice.Plugin.IceSSL=IceSSL:createIceSSL  
Ice.Plugin.Verifier=Verifier:createVerifierPlugin
```

The value of `Ice.PluginLoadOrder` guarantees that `IceSSL` is loaded first. The plug-in specification `Verifier:createVerifierPlugin` identifies the name of the shared library or DLL and the name of the registration function; see the description of the `Ice.Plugin` property in Appendix C for more information.

There are a few more details you must attend to, such as ensuring that the registration function is exported properly and building the shared library or DLL that contains the new plug-in. You can use `IceSSL` as an example if the correct approach is not clear.

40.7 Setting up a Certificate Authority

During development, it is convenient to have a simple way of creating new certificates. `OpenSSL` includes all of the necessary infrastructure for setting up your own certificate authority (CA), but it requires getting more familiar with `OpenSSL` than is really necessary. To simplify the process, `Ice` includes a collection of Python scripts, located in the `config/ca` subdirectory of your `Ice` installation, that hide the complexity of `OpenSSL` and allow you to quickly perform the essential tasks:

- initializing a new root CA
- generating new certificate requests
- signing certificate requests to create a valid certificate chain
- converting certificates to match platform-specific requirements.

You are not obligated to use these scripts; IceSSL accepts certificates from any source as long as they are provided in the appropriate formats. However, you may find these tools sufficient for your development needs, and possibly even for your deployed application as well.

Some of the scripts use a filesystem directory that contains configuration files and a database of issued certificates. The scripts select a default location for this directory that depends on your platform, or you can specify the parent directory explicitly by defining the `ICE_CA_HOME` environment variable and the scripts will use `$ICE_CA_HOME/ca` for their files.

40.7.1 Initializing a Certificate Authority

The script `initca.py` initializes a new CA by preparing a database directory and generating the root CA certificate and private key. It accepts the following command-line arguments:

```
$ python initca.py [--no-password] [--overwrite]
```

Upon execution, the script first checks the database directory to determine whether it has already been initialized. If so, the script terminates immediately with a warning unless you specify the `--overwrite` option, in which case the script overwrites the previous contents of the directory.

Next, the script displays the database directory it is using and begins to prompt you for the information it needs to generate the root CA certificate and private key. It offers a default choice for the CA's distinguished name and allows you to change it:

```
The subject name for your CA will be
CN=Grid-CA , O=GridCA-server
Do you want to keep this as the CA subject name? (y/n) [y]
```

To specify an alternate value for the distinguished name, enter `n` and type the new information, otherwise hit Enter to proceed.

```
Enter the email address of the CA: ca-admin@company.com
```

The address you provide in response to this prompt is shown to users that create certificate requests. Enter the address to which such requests should be sent.

The script shows its progress as it generates the certificate and private key, then prompts you for a pass phrase. If you prefer not to secure your CA's private key with a pass phrase, use the `--no-password` option.

Upon completion, the script emits the following instructions:

The CA is initialized.

You need to distribute the following files to all machines that can request certificates:

```
C:\iceca\req.cnf
C:\iceca\ca_cert.pem
```

These files should be placed in the user's home directory in `~/.iceca`. On Windows, place these files in `<ice-install>/config`.

In this example, the `ICE_CA_HOME` environment variable was set to `C:\iceca`. As the script states, the files `req.cnf` and `ca_cert.pem` must be present on each host that can generate a certificate request. The script suggests a location for these files, which is the default directory used by the scripts if `ICE_CA_HOME` is not defined.

The `ca_cert.pem` file contains the root CA's certificate. Your IceSSL configurations must identify this certificate (in its proper form for each platform) as a trusted certificate. For example, you can use this file directly in the configuration of the C++ plug-in:

```
IceSSL.CertAuthFile=C:\iceca\ca_cert.pem
```

For .NET 2.0 applications, you should import the certificate file into the proper store, as described in Section 40.4.3.

In Java, you need to add the certificate to your truststore:

```
$ keytool -import -trustcacerts -file ca_cert.pem -keystore ca.jks
Enter keystore password:
```

The `keytool` program requires you to enter a password, which you could use as the value of the property `IceSSL.TruststorePassword` (see Appendix C).

Now that your certificate authority is initialized, you can begin generating certificate requests.

40.7.2 Generating Certificate Requests

The script `req.py` uses the files you created in Section 40.7.1 to generate a request for a new certificate. It accepts the following command-line arguments:

```
$ python req.py [--overwrite] [--no-password]
[--node | --registry | --server | --user]
```

The script looks for the files `req.cnf` and `ca_cert.pem` in the directory defined by the `ICE_CA_HOME` environment variable. If that variable is not defined, the script uses a default directory that depends on your platform.

The purpose of the script is to gather information about the entity that needs a certificate and then generate two files: a private key and a file containing the certificate request. The request file must be transmitted to the certificate authority for signing, which produces a valid certificate chain.

The options `--node`, `--registry`, `--server` and `--user` indicate the type of entity requesting the certificate, where `--node` and `--registry` correspond to an IceGrid node and registry, respectively, `--server` means an Ice server and `--user` is a person. In reality, these options only influence the common name component of the new certificate's distinguished name as well as the names of the output files. If the output files already exist, you must specify `--overwrite` to force the script to overwrite them.

Once you have entered the requested information, the script displays its progress as it generates the necessary files. It will prompt you for a pass phrase unless you used the `--no-password` option, and finish by showing the names of the files it created as well as instructions on how to proceed. The example below shows the output from generating a request for a node:

```
Created key: node_key.pem
Created certificate request: node_req.pem
```

The certificate request must be signed by the CA. Send the certificate request file to the CA at the following email address:
ca-admin@company.com

The file `node_key.pem` is the new private key for the node; this file must be kept secure. The file `node_req.pem` must be given to the certificate authority. As a convenience, the script displays the CA's email address that you entered in Section 40.7.1.

40.7.3 Signing Certificate Requests

As a certificate authority, you are responsible for certifying the validity of certificate requests by signing them with your private key. The product of signing a request is a valid certificate chain that a person or application can use as an identity. The `sign.py` script performs this task for you and accepts the following command-line arguments:

```
$ sign.py --in <req> --out <cert>
```

The input file **req** is the certificate request, and the output file **cert** is the certificate chain. The script does not overwrite the file **cert** unless you also specify **-overwrite**.

Continuing the example from Section 40.7.2, we can sign the node's request with the following command:

```
$ python sign.py --in node_req.pem --out node_cert.pem
```

If the CA's private key is protected by a pass phrase, we must enter that first. Next, the script displays the relevant information from the certificate request and asks you to confirm that you wish to sign the certificate:

```
The Subject's Distinguished Name is as follows
organizationName      :PRINTABLE:'Company.com'
commonName            :PRINTABLE:'IceGrid Node TestNode'
Certificate is to be certified until Jun 15 18:32:36 2011 GMT
Sign the certificate? [y/n]:
```

After reviewing the request, enter **y** to sign the certificate, and **y** again to finish the process. Upon completion, the script stores the certificate chain in the file `node_cert.pem` in your current working directory. This file, together with the node's private key we created in Section 40.7.2, establishes a secure identity for the node.

40.7.4 Converting Certificates

For Java and .NET users, the private key and certificate chain must be converted into a suitable format for your platform. The script `import.py` simplifies this process and accepts the following command-line arguments:

```
$ python import.py [--overwrite]
  [--java alias cert key keystore]
  [--cs cert key out-file]
```

The script does not overwrite an existing file unless you specify **--overwrite**. To complete our node example from prior sections, the command below imports the private key and certificate chain into a Java keystore:

```
$ python import.py --java mycert node_cert.pem
node_key.pem cert.jks
```

The value `mycert` represents the alias associated with this entry in the keystore, and `cert.jks` is the name of the new keystore file. In an IceSSL configuration, the property `IceSSL.Keystore` refers to this file.

The equivalent command for .NET is shown below:

```
$ python import.py --cs node_cert.pem node_key.pem  
cert.pfx
```

The file `cert.pfx` uses the PKCS#12 encoding and contains the certificate chain and private key. You can import this certificate into a store, or refer directly to the file using the configuration property `IceSSL.CertFile`.

40.8 Summary

The Secure Socket Layer (SSL) protocol is the de facto standard for secure network communication. Its support for authentication, non-repudiation, data integrity, and strong encryption makes it the logical choice for securing Ice applications.

Although security is an optional component of Ice, it is not an afterthought. The IceSSL plug-in integrates easily into existing Ice applications, in most cases requiring nothing more than configuration changes. Naturally, some additional effort is required to create the necessary security infrastructure for an application, but in many enterprises this work will have already been done.

Chapter 41

Glacier2

41.1 Chapter Overview

In this chapter we present the Glacier2 service, a lightweight firewall solution for Ice applications. The basic requirements for using Glacier2 are discussed in Section 41.3. Glacier2 supports callbacks from servers to clients and Section 41.4 provides details about the configuration and application requirements necessary to use callbacks. Section 41.5 covers security issues, while Section 41.6 presents an overview of Glacier2 session management. Dynamic filtering is covered in Section 41.7. Section 41.8 describes Glacier2's buffering semantics, and Section 41.9 describes the handling of request contexts. The use of a network firewall in conjunction with Glacier2 is the topic of Section 41.10. Finally, clients with special requirements are addressed by Section 41.11, and IceGrid integration is the subject of Section 41.12.

41.2 Introduction

We have presented many examples of client/server applications in this book, all of which assume the client and server programs are running either on the same host, or on multiple hosts with no network restrictions. We can justify this assumption because this is an instructional text, but a real-world network environment is

usually much more complicated: client and server hosts with access to public networks often reside behind protective router-firewalls that not only restrict incoming connections, but also allow the protected networks to run in a private address space using Network Address Translation (NAT). These features, which are practically mandatory in today's hostile network environments, also disrupt the ideal world in which our examples are running.

41.2.1 Common Scenarios

Let us assume that a client and server need to communicate over an untrusted network, and that the client and server hosts reside in private networks behind firewalls, as shown in Figure 41.1.

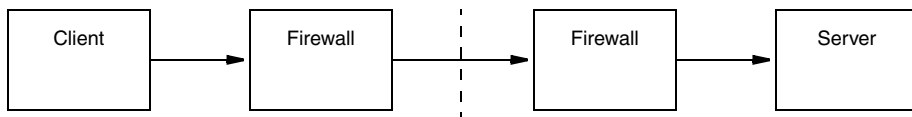

Figure 41.1. Client request in a typical network scenario.

Although the diagram looks fairly straightforward, there are several troublesome issues:

- A dedicated port on the server's firewall must be opened and configured to forward messages to the server.
- If the server uses multiple endpoints (e.g., to support both TCP and SSL), then a firewall port must be dedicated to each endpoint.
- The client's proxy must be configured to use the server's "public" endpoint, which is the hostname and dedicated port of the firewall.
- If the server returns a proxy as the result of a request, the proxy must not contain the server's private endpoint because that endpoint is inaccessible to the client.

To complicate the scenario even further, Figure 41.2 adds a callback from the server to the client. Callbacks imply that the client is also a server, therefore all of the issues associated with Figure 41.1 now apply to the client as well.

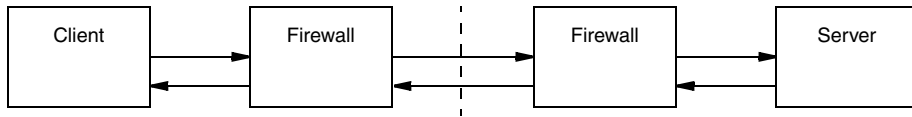

Figure 41.2. Callbacks in a typical network scenario.

As if this was not complicated enough already, Figure 41.3 adds multiple clients and servers. Each additional server (including clients requiring callbacks) adds more work for the firewall administrator as more ports are dedicated to forwarding requests.

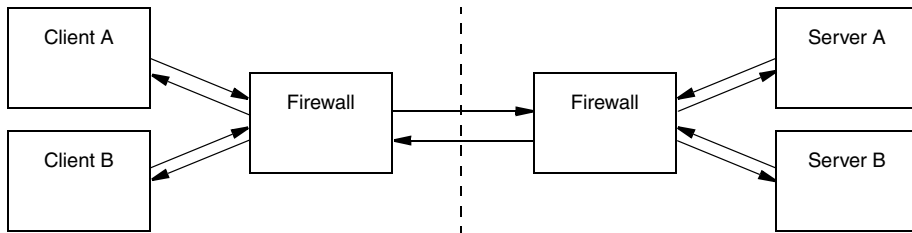

Figure 41.3. Multiple clients and servers with callbacks in a typical network scenario.

Clearly, these scenarios do not scale well, and are unnecessarily complex. Fortunately, Ice provides a solution.

41.2.2 What is Glacier2?

Glacier2, the router-firewall for Ice applications, addresses the issues raised in Section 41.2.1 with minimal impact on clients or servers (or firewall administrators). In Figure 41.4, Glacier2 becomes the server firewall for Ice applications.

What is not obvious in the diagram, however, is how Glacier2 eliminates much of the complexity of the previous scenarios.

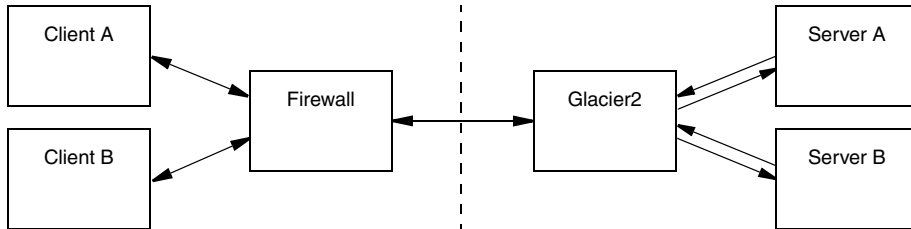

Figure 41.4. Multiple clients and servers with callbacks using Glacier.

In particular, Glacier2 provides the following advantages:

- Clients often require only minimal changes to use Glacier2.
- Only one front end port is necessary to support any number of servers, allowing a Glacier2 router to easily receive connections from a port-forwarding firewall.
- The number of connections to back end servers is reduced. Glacier2 effectively acts as a connection concentrator, establishing a single connection to each back end server to forward requests from any number of clients. Similarly, connections from back end servers to Glacier2 for the purposes of sending callbacks are also concentrated.
- Servers are unaware of Glacier2's presence, and require no modifications whatsoever to use Glacier2. From a server's perspective, Glacier2 is just another local client, therefore servers are no longer required to advertise "public" endpoints in the proxies they create. Furthermore, back-end services such as IceGrid (see Chapter 37) can continue to be used transparently via a Glacier2 router.
- Callbacks are supported without requiring new connections from servers to clients (see Section 41.4). In other words, a callback from a server to a client is sent over an existing connection from the client to the server, thereby eliminating the administrative requirements associated with supporting callbacks in the client firewall.
- Glacier2 requires no knowledge of the application's Slice definitions and therefore is very efficient: it routes request and reply messages without unmarshalling the message contents.

- In addition to its primary responsibility of forwarding Ice requests, Glacier2 offers support for user-defined session management and authentication, inactivity timeouts, and request buffering and batching.

41.2.3 How it works

The Ice core supports a generic router facility, represented by the `Ice::Router` interface, that allows a third-party service to “intercept” requests on a properly-configured proxy and deliver them to the intended server. Glacier2 is an implementation of this service, although other implementations are certainly possible.

Glacier2 normally runs on a host in the private network behind a port-forwarding firewall (see Section 41.10), but it can also operate on a host with access to both public and private networks. In this configuration it follows that Glacier2 must have endpoints on each network, as shown in Figure 41.5.

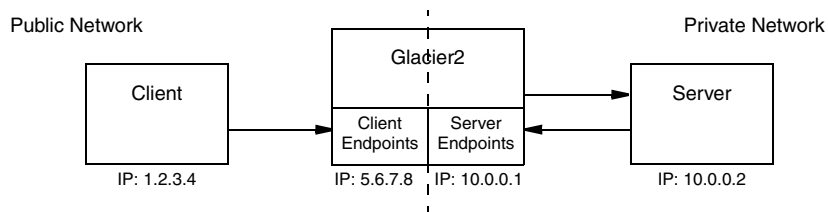

Figure 41.5. Glacier2’s client and server endpoints.

In the client, proxies must be configured to use Glacier2 as a router. This configuration can be done statically for all proxies created by a communicator, or programmatically for a particular proxy. A proxy configured to use a router is called a *routed proxy*.

When a client invokes an operation on a routed proxy, the client connects to one of Glacier2’s client endpoints and sends the request as if Glacier2 were the server. Glacier2 then establishes a client connection to the intended server, forwards the request, and returns the reply (if any). Glacier2 is essentially acting as a local client on behalf of the remote client.

If a server returns a proxy as the result of an operation, that proxy contains the server’s endpoints in the private network, as usual. (Remember, the server is unaware of Glacier2’s presence, and therefore assumes that the proxy is usable by the client that requested it.) Of course, those endpoints are not accessible to the client and, in the absence of a router, the client would receive an exception if it were to use the proxy. When that proxy is configured with a router, however, the

client ignores the server's endpoints and only sends requests to the router's client endpoints.

Glacier2's server endpoints, which reside in the private network, are only used when a server makes a callback to a client. See Section 41.4 for more information on callbacks.

41.2.4 Limitations

Glacier2 has the following limitations:

- Datagram protocols, such as UDP, are not supported.
- Callback objects in a client must use a Glacier2-supplied category in their identities (see Section 41.4).

41.3 Using Glacier2

Getting started with Glacier2 in a minimal configuration involves the following tasks:

1. Write a configuration file for the router.
2. Write a password file for the router. (Section 41.5 discusses alternative ways to authenticate users.)
3. Decide whether to use the router's internal session manager, or supply your own (see Section 41.6).
4. Start the router on a host with access to the public and private networks.
5. Modify the client configuration to use the router.
6. Modify the client to create a router session.

For the sake of example, let us assume that the router's public address is 5.6.7.8 and its private address is 10.0.0.1.

41.3.1 Configuring the Router

The following router configuration properties establish the necessary endpoint and define when a session expires due to inactivity:

```
Glacier2.Client.Endpoints=tcp -h 5.6.7.8 -p 8000
Glacier2.SessionTimeout=60
```

The endpoint defined by `Glacier2.Client.Endpoints` is used by the Ice run time in a client to interact directly with the router. It is also the endpoint where requests from routed proxies are sent. This endpoint is defined on the public network interface because it must be accessible to clients.¹ Furthermore, the endpoint uses a fixed port because clients may be statically configured with a proxy for this endpoint.

A client's session is destroyed when explicitly requested, or when the session is inactive for a configurable number of seconds. For this example, we have specified a timeout of 60 seconds. It is not mandatory to define a timeout, but it is recommended, otherwise session state might accumulate in the router. See Section 41.6 for more information on sessions.

Note that this configuration enables the router to forward requests from clients to servers, but not from servers to clients (that is, it cannot forward callbacks). We discuss callbacks in Section 41.4.

You must also decide which authentication scheme (or schemes) to use. Section 41.3.2 describes a file-based mechanism, and Section 41.5 covers the router's more sophisticated facilities.

If clients access a location service via the router, additional router configuration is typically necessary (see Section 37.13).

41.3.2 Writing a Password File

The router's simplest authentication mechanism uses an access control list in a file consisting of user name–password pairs. The password is a 13-character string encoded using the `crypt` algorithm, similar to a `passwd` file on a typical Unix system. The property `Glacier2.CryptPasswords` specifies the name of the password file:

```
Glacier2.CryptPasswords=passwords
```

The format of the password file is very simple. Each user name–password pair must reside on a separate line, with whitespace separating the user name from the password. For example, the following password file contains an entry for the user name `test`:

```
test xxMqsnnDcK8tw
```

1. This sample configuration uses TCP as the endpoint protocol, although in most cases SSL is preferable (see Section 41.5).

You can use the `openssl` utility (included in the OpenSSL toolkit) to generate `crypt` passwords:

```
$ openssl
OpenSSL> passwd
Password:
Verifying - Password:
xxMqsnnDcK8tw
```

At the prompt, issue the `passwd` command. You are asked for a password, and then asked to confirm the password, at which point the utility displays the `crypt`-encoded version of your password that you can paste into the router's password file.

41.3.3 Starting the Router

Assuming the configuration properties shown in Section 41.3.1 and Section 41.3.2 are stored in a file named `config`, you can start the router with the following command:

```
$ glacier2router --Ice.Config=config
```

Additional command line options are supported, including those that allow the router to run as a Windows service or Unix daemon. See Section 8.3.2 for more information.

41.3.4 Configuring the Client

The following properties configure a client to use a Glacier2 router:

```
Ice.Default.Router=Glacier2/router:tcp -h 5.6.7.8 -p 8000
Ice.ACM.Client=0
Ice.MonitorConnections=60
Ice.RetryIntervals=-1
```

The value of the `Ice.Default.Router` property is a proxy whose endpoints must match those in `Glacier2.Client.Endpoints`.

The property `Ice.ACM.Client` governs the behavior of *active connection management* (ACM, see Section 35.4), which conserves resources by periodically closing idle outgoing connections. This feature must be disabled in a client that uses a Glacier2 router, otherwise ACM might transparently close a client's connection to a router and thereby terminate the router session prematurely. ACM

is enabled by default, and therefore must be disabled by setting this property to zero.

For clients that use AMI, we set `Ice.MonitorConnections` so that AMI timeouts operate correctly. This property, if not defined, uses the value of `Ice.ACM.Client` by default. Since we are disabling ACM by setting `Ice.ACM.Client` to zero, we must specify an explicit value for `Ice.MonitorConnections`. In this example, we use a value of 60 seconds.

Finally, setting `Ice.RetryIntervals` to `-1` disables automatic retries, which are not useful for proxies configured to use a Glacier2 router.

41.3.5 Object Identities

A Glacier2 router hosts two well-known objects. The default identities of these objects are `Glacier2/router` and `Glacier2/admin`, corresponding to the `Glacier2::Router` and `Glacier2::Admin` interfaces, respectively. If an application requires the use of multiple routers, it is a good idea to assign unique identities to these objects by configuring the routers with different values of the `Glacier2.InstanceName` property, as shown in the following example:

```
Glacier2.InstanceName=PublicRouter
```

This property changes the category of the object identities, which become `PublicRouter/router` and `PublicRouter/admin`. The client's configuration must also be changed to reflect the new identity:

```
Ice.Default.Router=PublicRouter/router:tcp -h 5.6.7.8 -p 8000
```

41.3.6 Creating a Session

Session management is provided by the `Glacier2::Router` interface:²

```
module Glacier2 {
    exception PermissionDeniedException {
        string reason;
    };

    interface Router extends Ice::Router {
        Session* createSession(string userId, string password)
            throws PermissionDeniedException,

```

2. The `getCategoryForClient` operation is used for bidirectional connections (see page 1392).

```

        CannotCreateSessionException;

        Session* createSessionFromSecureConnection()
            throws PermissionDeniedException,
                CannotCreateSessionException;

        nonmutating string getCategoryForClient();

        nonmutating long getSessionTimeout();

        void destroySession()
            throws SessionNotExistException;
    };
};

```

The interface defines two operations for creating sessions: `createSession` and `createSessionFromSecureConnection`. The router requires each client to create a session using one of these operations; only after the session is created will the router forward requests on behalf of the client.

The `createSession` operation expects a user name and password, and returns a `Session` proxy or `nil`, depending on the router's configuration (see Section 41.6). When using the default authentication scheme, the given user name and password must match an entry in the router's password file in order to successfully create a session.

The `createSessionFromSecureConnection` operation does not require a user name and password because it uses the credentials supplied by an SSL connection to authenticate the client (see Section 41.5).

To create a session, the client typically obtains the router proxy from the communicator, downcasts the proxy to the `Glacier2::Router` interface, and invokes one of the operations. The sample code below demonstrates how to do it in C++; the code will look very similar in the other language mappings.

```

Ice::RouterPrx defaultRouter =
    communicator->getDefaultRouter();
Glacier2::RouterPrx router =
    Glacier2::RouterPrx::checkedCast(defaultRouter);
string username = ...;
string password = ...;
Glacier2::SessionPrx session;
try
{
    session = router->createSession(username, password);
}

```

```
catch(const Glacier2::PermissionDeniedException& ex)
{
    cout << "permission denied:\n" << ex.reason << endl;
}
catch(const Glacier2::CannotCreateSessionException& ex)
{
    cout << "cannot create session:\n" << ex.reason << endl;
}
```

If the router is configured with a session manager, the `createSession` and `createSessionFromSecureConnection` operations may return a proxy for an object implementing the `Glacier2::Session` interface (or an application-specific derived interface). The client receives a null proxy if no session manager is configured.

In order to successfully use a session proxy, it must be configured with the router that created it; that is, the session object is only accessible via the router. If the router is configured as the client's default router at the time `createSession` or `createSessionFromSecureConnection` is invoked, as is the case in the example above, then the session proxy is already properly configured and nothing else is required. Otherwise, the client must explicitly configure the session proxy with a router using the `ice_router` proxy method (see Section 31.10.1).

If the client wishes to destroy the session explicitly, it must invoke `destroySession` on the router proxy. If a client does not destroy its session, the router destroys it automatically when it expires due to inactivity. A client can obtain the inactivity timeout value by calling `getSessionTimeout` (see Section 41.6.2).

Note that a router client must be prepared for the `destroySession` operation to raise `ConnectionLostException`, as shown in the following C++ example:

```
try {
    router->destroySession();
} catch (const Ice::ConnectionLostException&) {
    // Expected
}
```

The exception occurs because the router forcefully closes the client's connection to indicate that the session is no longer valid.

An example of a Glacier2 client is provided in the directory `demo/Glacier2/callback`.

41.4 Callbacks

Callbacks from servers to clients are commonly used in distributed applications, often for notification purposes (such as the completion of a long-running calculation or a change to a database record). Unfortunately, supporting callbacks in a complicated network environment presents its own set of problems, as described in Section 41.2.1. Ice overcomes these obstacles using a Glacier2 router and bidirectional connections.

41.4.1 Bidirectional Connections

While a regular unrouted connection allows requests to flow in only one direction (from client to server), a bidirectional connection enables requests to flow in both directions. This capability is necessary to circumvent the network restrictions discussed in Section 41.2.1, namely, client-side firewalls that prevent a server from establishing an independent connection directly to the client. By sending callback requests over the existing connection from the client to the server (more accurately, from the client to the router), we have created a virtual connection back to the client. Figure 41.6 illustrates the steps involved in making a callback using Glacier2.

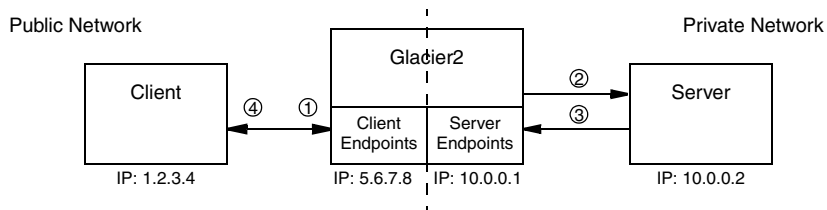

Figure 41.6. A callback via Glacier2.

1. The client has a routed proxy for the server and makes an invocation. A connection is established to the router's client endpoint and the request is sent to the router.
2. The router, using information from the client's proxy, establishes a connection to the server and forwards the request. In this example, one of the arguments in the request is a proxy for a callback object in the client.
3. The server makes a callback to the client. For this to succeed, the proxy for the callback object must contain endpoints that are accessible to the server. The

only path back to the client is through the router, therefore the proxy contains the router's server endpoints (see Section 41.4.3). The server connects to the router and sends the request.

4. The router forwards the callback request to the client using the bidirectional connection established in step 1.

The arrows in Figure 41.6 indicate the flow of requests; notice that two connections are used between the router and the server. Since the server is unaware of the router, it does not use routed proxies, and therefore does not use bidirectional connections.

It is also possible for applications to manually configure bidirectional connections without the use of a router, as described in Section 35.7.

41.4.2 Lifetime of a Bidirectional Connection

When a client terminates, it closes its connection to the router. If a server later attempts to make a callback to the client, the attempt fails because the router has no connection to the client over which to forward the request. This situation is no worse than if the server attempted to contact the client directly, which would be prevented by the client firewall. However, this illustrates the inherent limitation of bidirectional connections: the lifetime of a client's callback proxy is bounded by the lifetime of the client's router session.

41.4.3 Configuring the Router

In order for the router to support callbacks from servers, it needs to have endpoints in the private network. The configuration file shown below adds the property `Glacier2.Server.Endpoints`:

```
Glacier2.Client.Endpoints=tcp -h 5.6.7.8 -p 8000
Glacier2.Server.Endpoints=tcp -h 10.0.0.1
```

As the example shows, the server endpoint does not require a fixed port.

41.4.4 Configuring the Client's Object Adapter

A client that receives callbacks is also a server, and therefore must have an object adapter. Typically, an object adapter has endpoints in the local network, but those endpoints are of no use to a server in our restricted network environment. We really want the client's callback proxy to contain the router's server endpoints, and

we accomplish that by configuring the client's object adapter with a proxy for the router³. We supply the router's proxy by creating the object adapter with `createObjectAdapterWithRouter`, or by defining an object adapter property as shown below:

```
CallbackAdapter.Router=Glacier2/router:tcp -h 5.6.7.8 -p 8000
```

For each object adapter, the Ice run time maintains a list of endpoints that are embedded in proxies created by that adapter (see Section 31.4.6). Normally, this list simply contains the local endpoints defined for the object adapter but, when the adapter is configured with a router, the list only contains the router's server endpoints. When using a router, this object adapter allows the client to service callback requests via the router. Because the adapter only contains the router's server endpoints, this means that, if the client also wants to service requests via local (non-routed) endpoints, the client must create a separate adapter for these requests.

41.4.5 Callback Object Identities

Glacier2 assigns a unique category to each client for use in the identities of the client's callback objects. The client creates proxies that contain this identity category for back-end servers to use when making callback requests to the client. This category serves two purposes:

1. Upon receipt of a callback request from a back-end server, the router uses the request's category to identify the intended client.
2. The category is sufficiently random that, without knowing the category in advance, it is practically impossible for a misbehaving or malicious back-end server to send callback requests to an arbitrary client.

A client can obtain its assigned category by calling `getCategoryForClient` on the Router interface as shown in the C++ example below:

```
Glacier2::RouterPrx router = // ...  
string category = router->getCategoryForClient();
```

3. Note that multiple object adapters created by the same communicator cannot use the same router.

41.4.6 Example

The `demo/Glacier2/callback` example illustrates the use of callbacks with Glacier2. The `README` file in the directory provides instructions on running the example, and comments in the configuration file describe the properties in detail.

41.5 Router Security

As a firewall, a Glacier2 router represents a doorway into a private network, and in most cases that doorway should have a good lock. The obvious first step is to use SSL for the router's client endpoints. This allows you to secure the message traffic and restrict access to clients having the proper credentials (see Chapter 40). However, the router takes security even further by providing access control and filtering capabilities.

41.5.1 Access Control

The authentication capabilities of SSL may not be sufficient for all applications: the certificate validation phase of the SSL handshake verifies that the user is who he says he is, but how do we know that he should be allowed to use the router? Glacier2 addresses this issue through the use of an access control facility that supports two forms of authentication: passwords and certificates. You can configure the router to use whichever authentication method is most appropriate for your application, or you can configure both methods in the same router.

Password Authentication

The router verifies the user name and password arguments to its `createSession` operation before it forwards any requests on behalf of the client. Given that the password is sent "in the clear," it is important to protect these values by using an SSL connection with the router. Section 41.3.6 demonstrates how to use the `createSession` operation.

There are two ways for the router to verify a user name and password. By default, the router uses a file-based access control list, but you can override this behavior by installing a proxy for an application-defined verifier object. Configuration properties define the password filename or the verifier proxy; if you install a verifier proxy, the password file is ignored. Since we have already discussed the password file in Section 41.3.2, we will focus on the custom verifier interface in the remainder of this section.

An application that has special requirements can implement the interface `Glacier2::PermissionsVerifier` to gain programmatic control over access to a router. This can be especially useful in situations where a repository of account information already exists (such as an LDAP directory), in which case duplicating that information in another file would be tedious and error-prone.

The Slice definition for the interface contains just one operation:

```
module Glacier2 {
    interface PermissionsVerifier {
        nonmutating
        bool checkPermissions(string userId, string password,
                               out string reason);
    };
};
```

The router invokes `checkPermissions` on the verifier object, passing it the user name and password arguments that were given to `createSession`. The operation must return true if the arguments are valid, and false otherwise. If the operation returns false, a reason can be provided in the output parameter.

To configure a router with a custom verifier, set the configuration property `Glacier2.PermissionsVerifier` with the proxy for the object.

A sample implementation of the `PermissionsVerifier` interface is provided in the `demo/Glacier2/callback` directory.

Certificate Authentication

As shown in Section 41.3.6, the `createSessionFromSecureConnection` operation does not require a user name or password because the client's SSL connection to the router already supplies the credentials necessary to sufficiently identify the client, in the form of X.509 certificates. (See Chapter 40 for details on IceSSL configuration.)

It is up to you to decide what constitutes sufficient identification. For example, a single certificate could be shared by all clients if there is no need to distinguish between them, or you could generate a unique certificate for each client or a group of clients. Glacier2 does not enforce any particular policy, but simply delegates the decision of whether to accept the client's credentials to an application-defined object that implements the `Glacier2::SSLPermissionsVerifier` interface:

```
module Glacier2 {
    interface SSLPermissionsVerifier {
        nonmutating bool authorize(SSLInfo info,
                                   out string reason);
    };
};
```

Router clients may only use `createSessionFromSecureConnection` if the router is configured with a proxy for an `SSLPermissionsVerifier` object. The implementation of `authorize` must return `true` to allow the client to establish a session. To reject the session, `authorize` must return `false` and may optionally provide a value for `reason`, which is returned to the client as a member of `PermissionDeniedException`.

The verifier examines the members of `SSLInfo` to authenticate a client:

```
module Glacier2 {
    struct SSLInfo {
        string remoteHost;
        int remotePort;
        string localHost;
        int localPort;
        string cipher;
        Ice::StringSeq certs;
    };
};
```

The structure includes address information about the remote and local hosts, and a string that describes the ciphersuite negotiated for the SSL connection between the client and the router. These values are generally of interest for logging purposes, whereas the `certs` member supplies the information the verifier needs to make its decision. The client's certificate chain is represented as a sequence of strings that use the Privacy Enhanced Mail (PEM) encoding. The first element of the sequence corresponds to the client's certificate, followed by its signing certificates. The certificate of the root Certificate Authority (CA) is the last element of the sequence. An empty sequence indicates that the client did not supply a certificate chain.

Although the certificate chain has already been validated by the SSL implementation, a verifier implementation typically needs to examine it in detail before making its decision. As a result, the verifier will need to convert the contents of `certs` into a more usable form. Some Ice platforms, such as Java and .NET 2, already provide certificate abstractions, and `IceSSL` supplies its own for C++ users. `IceSSL` for Java and .NET 2 defines the method

`IceSSL.Util.createCertificate`, which accepts a PEM-encoded string and returns an instance of the platform's certificate class. In C++, the class `IceSSL::Certificate` has a constructor that accepts a PEM-encoded string. Chapter 40 provides the relevant details.

In addition to examining certificate attributes such as the distinguished name of the subject and issuer, it is also important that a verifier consider the length of the certificate chain. Refer to Section 40.4.5 for a discussion of this issue.

To install your verifier, set the `Glacier2.SSLPermissionsVerifier` property with the proxy of your verifier object.

41.5.2 Filtering

The Glacier2 router is capable of filtering requests based on a variety of criteria, which helps to ensure that clients do not gain access to unintended objects.

Address Filters

To prevent a client from accessing arbitrary back-end hosts or ports, you can configure a Glacier2 router to validate the address information in each proxy the client attempts to use. Two properties determine the router's filtering behavior:

- `Glacier2.Filter.Address.Accept`

An address is accepted if it matches an entry in this property and does not match an entry in `Glacier2.Filter.Address.Reject`.

- `Glacier2.Filter.Address.Reject`

An address is rejected if it matches an entry in this property.

The value of each property is a list of *address:port* pairs separated by spaces, as shown in the example below:

```
Glacier2.Filter.Address.Accept=192.168.1.5:10000 192.168.1.6:10000
```

This configuration allows clients to use only two hosts in the back-end network, and only one port on each host. A client that attempts to use a proxy containing any other host or port receives an `ObjectNotExistException` on its initial request.

You can also use ranges, groups and wildcards when defining your address filters. For example, the following property value shows how to use an address range:

```
Glacier2.Filter.Address.Accept=192.168.1.[5-6]:10000
```

This property is equivalent to the first example, but the range notation allows us to define the filter more concisely. Similarly, we can restate the property using the group notation by separating values with a comma:

```
Glacier2.Filter.Address.Accept=192.168.1.[5,6]:10000
```

The wildcard notation uses the `*` character to substitute for a value:

```
Glacier2.Filter.Address.Accept=10.0.*.1:10000
```

The range, group, and wildcard notation is also supported when specifying ports, as shown below:

```
Glacier2.Filter.Address.Accept=192.168.1.[5,6]:[10000-11000]  
Glacier2.Filter.Address.Reject=192.168.1.[5,6]:[10500,10501]
```

In this configuration, the router allows clients to access all of the ports in the range 10000 to 11000, except for the two ports 10500 and 10501.

At first glance, you might think that the following property definition is pointless because it would prevent clients from accessing any back-end server:

```
Glacier2.Filter.Address.Reject=*
```

In reality, this configuration only prevents clients from accessing servers using direct proxies, that is, proxies that contain endpoints. As a result, the property causes Glacier2 to accept only indirect proxies (see Section 2.2.2).

NOTE: By default, a Glacier2 router forwards requests for any address, which is equivalent to defining the property `Glacier2.Filter.Address.Accept=*`.

Category Filters

As described in Section 31.5, the `Ice::Identity` type contains two string members: `category` and `name`. You can configure a router with a list of valid identity categories, in which case it only routes requests for objects in those categories. The configuration property `Glacier2.Filter.Category.Accept` supplies the category list:

```
Glacier2.Filter.Category.Accept=cat1 cat2
```

This property does not affect the routing of callback requests from back-end servers to router clients. See Section 41.4 for more information on callbacks.

NOTE: By default a Glacier2 router forwards requests for any category.

If a category contains spaces, you can enclose the value in single or double quotes. If a category contains a quote character, it must be escaped with a leading backslash.

A session manager can also configure category filters dynamically; see Section 41.7 for details.

Identity Filters

The ability to filter on identity categories, as described in the previous section, is a convenient way to limit clients to particular groups of objects. For even stricter control over the identities that clients are allowed to access, you can use the `Glacier2.Filter.Identity.Accept` property. The value of this property is a list of identities, separated by whitespace, representing the *only* objects the router's clients may use.

If an identity contains spaces, you can enclose the value in single or double quotes. If an identity contains a quote character, it must be escaped with a leading backslash.

Clearly, specifying a static list of identities is only practical for a small set of objects. Furthermore, in many applications, the complete set of identities cannot be known in advance, such as when objects are created on a per-session basis and use UUIDs in their identities. For these situations, category-based filtering is generally sufficient. However, a session manager can also use Glacier2's dynamic filtering interface, `SessionControl`, to manage the set of valid identities at run time. See Section 41.7 for more information.

Adapter Filters

Applications often use IceGrid in their back-end network to simplify server administration and take advantage of the benefits offered by indirect proxies. Once you have configured Glacier2 with an appropriate locator (see Section 41.12), clients can use indirect proxies to refer to objects in IceGrid-managed servers. Recall from Section 2.2.2 that an indirect proxy comes in two forms: one that contains only an identity, and one that contains an identity and an object adapter identifier. You can use the category and identity filters described in previous sections to control identity-only proxies, and you can use the property `Glacier2.Filter.AdapterId.Accept` to enforce restrictions on indirect proxies that use an object adapter identifier.

For example, the following property definition allows a client to use the proxy `factory@WidgetAdapter` but not the proxy `factory@SecretAdapter`:

```
Glacier2.Filter.AdapterId.Accept=WidgetAdapter
```

If an adapter identifier contains spaces, you can enclose the value in single or double quotes. If an adapter identifier contains a quote character, it must be escaped with a leading backslash.

A session manager can also configure this filter dynamically, as described in Section 41.7.

Proxy Filters

The Glacier2 router maintains an internal routing table that contains an entry for each proxy used by a router client; the size of the routing table grows in proportion to the number of clients and their proxy usage. Furthermore, the amount of memory that the routing table consumes is affected by the number of endpoints in each proxy. Glacier2 provides two properties that you can use to limit the size of the routing table and defend against malicious router clients.

The property `Glacier2.RoutingTable.MaxSize` specifies the maximum number of entries allowed in the routing table. If the size of the table exceeds the value of this property, the router evicts older entries on a least-recently-used basis. (Eviction of proxies from the routing table is transparent to router clients.) The default size of the routing table is 1000, but you may need to define a different value depending on the needs of your application. While experimenting with different values, you may find it useful to define the property `Glacier2.Trace.RoutingTable` to see a log of the router's activities with respect to the routing table.

The property `Glacier2.Filter.ProxySizeMax` sets a limit on the size of a stringified proxy. The Ice run time places no limits on the size of proxy components such as identities and hostnames, but a malicious client could manufacture very large proxies in a denial-of-service attack on a Glacier2 router. By setting this property to a reasonably small value, you can prevent proxies from consuming excessive memory in the router process.

Client Impact

The Glacier2 router immediately terminates a client's session if it attempts to use a proxy that is rejected by an address filter or exceeds the size limit defined by the property `Glacier2.Filter.ProxySizeMax`. The Ice run time in the client responds by raising `ConnectionLostException` to the application.

If a client attempts to use a proxy that is rejected by a category, identity or adapter identifier filter, the router raises `ObjectNotExistException`.

To obtain more information on the router's reasons for terminating a session or rejecting a request, set the following property and examine the router's log output:

```
Glacier2.Client.Trace.Reject=1
```

41.5.3 Administration

Glacier2 supports an administrative interface that allows you to shut down a router programmatically:

```
module Glacier2 {
    interface Admin {
        idempotent void shutdown();
    };
};
```

To prevent unwanted clients from using the `Admin` interface, the object is only accessible on the endpoints defined by the `Glacier2.Admin.Endpoints` property. This property has no default value, meaning the `Admin` interface is inaccessible unless you explicitly define it.

The `Glacier2.Admin.Endpoints` property also affects session managers because the `SessionControl` proxy supplied by the router uses the administrative endpoints. If the property is not defined, session managers receive a null proxy instead. See Section 41.6 for an introduction to session managers and Section 41.7 for more information on the `SessionControl` interface.

If you decide to define `Glacier2.Admin.Endpoints`, choose your endpoints carefully. We generally recommend the use of endpoints that are accessible only from behind a firewall.

41.6 Session Management

A Glacier2 router requires a client to create a session (see Section 41.3.6) and forwards requests on behalf of the client until its session expires. A session expires when it is explicitly destroyed, or when it times out due to inactivity.

If your application needs to track the session activities of a router, you can configure the router to use a custom session manager. For example, your application may need to acquire resources and initialize the state of back-end services for each new session, and later reclaim those resources when the session expires.

As with the authentication facility described in Section 41.5, Glacier2 provides two session manager interfaces that an application can implement. The `SessionManager` interface receives notifications about sessions that use password authentication, while the `SSLSessionManager` interface is for sessions authenticated using SSL certificates.

41.6.1 The Session Manager Interfaces

The relevant Slice definitions are shown below:

```
module Glacier2 {
    exception CannotCreateSessionException {
        string reason;
    };

    interface Session {
        void destroy();
    };

    interface SessionManager {
        Session* create(string userId, SessionControl* control)
            throws CannotCreateSessionException;
    };

    interface SSLSessionManager {
        Session* create(SSLInfo info, SessionControl* control)
            throws CannotCreateSessionException;
    };
};
```

When a client invokes `createSession` on the Router interface (see Section 41.3.6), the router validates the client's user name and password and then calls `SessionManager::create`. Similarly, a call to `createSessionFromSecureConnection` causes the router to invoke `SSLSessionManager::create`. The `SSLInfo` structure is described in Section 41.5.1. The second argument to the create operations is a proxy for a `SessionControl` object, which a session can use to perform dynamic filtering (see Section 41.7).

The create operations must return the proxy of a new `Session` object, or raise `CannotCreateSessionException` and provide an appropriate reason. The `Session` proxy returned by `create` is ultimately returned to the client as the result of `createSession` or `createSessionFromSecureConnection`.

Glacier2 invokes the `destroy` operation on a `Session` proxy when the session expires. This provides a custom session manager with the opportunity to reclaim resources that were acquired for the session during `create`.

NOTE: The `create` operations may be called with information that identifies an existing session. For example, this can occur if a client has lost its connection to the router and therefore must create a new session but its previous session has not expired yet, and the router therefore has not yet invoked `destroy` on its `Session` proxy. A session manager implementation must be prepared to handle this situation.

To configure the router with a custom session manager, define the properties `Glacier2.SessionManager` or `Glacier2.SSLSessionManager` with the proxies of the session manager objects. If necessary, you can configure a router with proxies for both types of session managers.

If a session manager proxy is not supplied, the call to `createSession` or `createSessionFromSecureConnection` always returns a null proxy.

A sample implementation of the `SessionManager` interface is provided in the `demo/Glacier2/callback` directory.

41.6.2 Session Timeouts

The value of the `Glacier2.SessionTimeout` property specifies the number of seconds a session must be inactive before it expires. If the property is not defined, then sessions never expire due to inactivity. If a non-zero value is specified, it is very important that the application chooses a value that does not result in premature session expiration. For example, if it is normal for a client to create a session and then have long periods of inactivity, then a suitably long timeout must be chosen, or timeouts must be disabled altogether.

Once a session has expired (or been destroyed for some other reason), the client will no longer be able to send requests via the router, but instead receives a `ConnectionLostException`. The client must explicitly create a new session in order to continue using the router. If necessary, clients can use a dedicated thread to keep their sessions alive. The router operation `getSessionTimeout` allows a client to determine the timeout period (see Section 41.3.6). The example in `demo/Glacier2/chat` shows how to use a thread to prevent premature session termination.

In general, we recommend the use of an appropriate session timeout, otherwise resources created for each session will accumulate in the router.

41.6.3 Connection Caching

Glacier2 disables connection caching on session manager proxies, therefore if you configure the router with a session manager proxy that contains multiple endpoints, the router attempts to use a different endpoint for each invocation on a session manager. The purpose of this behavior is to distribute the load among multiple active session manager objects without using the replication features provided by IceGrid. Be aware that including an invalid endpoint in your session manager proxy, such as the endpoint of a session manager server that is not currently running, can cause router clients to experience delays during session creation.

If your session managers are in a replica group, Section 41.12.2 provides more information on the router's caching behavior.

41.7 Dynamic Filtering

Section 41.5.2 described various ways of statically configuring a router to filter requests. Glacier2 also allows a session manager to customize filters for each session at run time via its `SessionControl` interface:

```
module Glacier2 {
    interface SessionControl {
        StringSet* categories();
        StringSet* adapterIds();
        IdentitySet* identities();
        void destroy();
    };
};
```

The router creates a `SessionControl` object for each client session and supplies a proxy for the object to the session manager create operations (see Section 41.6). Note that the `SessionControl` proxy is null unless the router is configured with administrative endpoints, as explained in Section 41.5.3.

Invoking the `destroy` operation causes the router to destroy the client's session, which eventually results in an invocation of `destroy` on the application-defined `Session` object, if one was provided.

The interface operations `categories`, `adapterIds` and `identities` return proxies to objects representing the modifiable filters for the session. The router initializes these filters using their respective static configuration properties.

The `SessionControl` object uses a `StringSet` to manage the category and adapter identifier filters:

```
module Glacier2 {
    interface StringSet {
        idempotent void add(Ice::StringSeq additions);
        idempotent void remove(Ice::StringSeq deletions);
        idempotent Ice::StringSeq get();
    };
};
```

Similarly, the `IdentitySet` interface manages the identity filters:

```
module Glacier2 {
    interface IdentitySet {
        idempotent void add(Ice::IdentitySeq additions);
        idempotent void remove(Ice::IdentitySeq deletions);
        idempotent Ice::IdentitySeq get();
    };
};
```

In both interfaces, the `add` operation silently ignores duplicates, and the `remove` operation silently ignores non-existent entries.

Dynamic filtering is often necessary when each session must be restricted to a particular group of objects. Upon session creation, a session manager typically allocates a number of objects in back-end servers for that session to use. To prevent other sessions from accessing these objects (intentionally or not), the session manager can configure the session's filters so that it is only permitted to use the objects that were created for it.

For example, a session manager can retain the `SessionControl` proxy and add a new identity to the `IdentitySet` as each new object is created for the session. A simpler solution is to create a unique identifier for the session, add it to the session's category filter, and use that category in the identities of all of the objects accessible by that session. Using a category filter in this way reserves an identity namespace for each session and avoids the need to update the filter for each new object.

To aid in logging and debugging, you can select a category that identifies the client, such as the user name that was supplied during session creation, or an attribute of the client's certificate such as the common name, as long as the selected category is sufficiently unique that it will not conflict with another client's session. You must also ensure that the categories you assign to sessions never match the categories of back-end objects that are not meant to be accessed

by router clients. As an example, consider the following session manager implementation:

```
class SessionManagerI : public Glacier2::SessionManager
{
public:

    virtual Glacier2::SessionPrx
    create(const string& username,
           const Glacier2::SessionControlPrx& ctrl,
           const Ice::Current& curr)
    {
        string category = "_" + username;
        ctrl->categories()->add(category);
        // ...
    }
};
```

This session manager derives a category for the session by prepending an underscore to the user name and then adds this category to the session's filter. As long as our back-end objects do not use a leading underscore in their identity categories, this guarantees that a session's category can never match the category of a back-end object.

41.8 Request Buffering

A Glacier2 router can forward requests in buffered or unbuffered mode. In addition, the buffering mode can be set independently for each direction (client-to-server and server-to-client).

The configuration properties `Glacier2.Client.Buffered` and `Glacier2.Server.Buffered` govern the buffering behavior. The former affects buffering of requests from clients to servers, and the latter affects buffering of requests from servers to clients. If a property is not specified, the default value is 1, which enables buffering. A property value of 0 selects the unbuffered mode.

41.8.1 Unbuffered Mode

In unbuffered mode, the router forwards an incoming request in the same thread that received the request. This mode uses fewer resources than buffered mode, but it also has some limitations:

- Nested twoway requests are not supported.
- Twoway requests are serialized. After forwarding a twoway request to a server, the router cannot forward any more requests from that client until the server has responded to the first request. The same is true for twoway requests from servers to clients.
- It is susceptible to denial-of-service attacks by hostile clients when used for requests from servers to clients (i.e., only when the property `Glacier2.Server.Buffered` is set to zero). For example, a client that receives a callback from a server and blocks indefinitely inside the callback can disable communications for all other clients.

However, for some applications, the lower resource requirements of the unbuffered mode are attractive enough to warrant a careful application design that addresses this mode's limitations.

41.8.2 Buffered Mode

In buffered mode, the router queues incoming requests and creates an extra thread (or two⁴) dedicated to processing the request queue of each connected client. While buffered mode consumes more resources than unbuffered mode, it does not suffer the limitations of unbuffered mode described in Section 41.8.1. Furthermore, buffered mode offers some additional functionality not available in unbuffered mode, such as the ability to batch requests (see Section 41.9.3).

The configuration properties `Glacier2.Client.SleepTime` and `Glacier2.Server.SleepTime` can be used to ensure that a single client or server, respectively, does not flood the router with requests. A non-zero value causes the router's thread dedicated to a connection to sleep for the specified number of milliseconds after it has sent all of the pending requests. Incoming requests are queued while the connection's thread is asleep.

If a property is not defined, or its value is zero, then the router's thread does not sleep after sending queued requests.

4. The router creates a thread if `Glacier2.Client.Buffered=1`, and another thread if `Glacier2.Server.Buffered=1`.

41.9 Request Contexts

The Glacier2 router examines the context of an incoming request (see Section 31.11) for special keys that affect how the router forwards the request. These contexts have the same semantics regardless of whether the request is sent from client to server or from server to client.

41.9.1 `_fwd`

The `_fwd` context determines the proxy mode that the router uses when forwarding the request. The value associated with the `_fwd` key must be a string containing one or more of the characters shown in Table 41.1.

Table 41.1. Legal values for `_fwd` context key.

Value	Mode
d	Datagram
D	Batch datagram
o	Oneway
O	Batch oneway
s	Secure
t	Twoway
z	Compress

These characters match the stringified proxy options described in Appendix D.

For requests whose `_fwd` context specify a batch mode, the forwarding behavior of the router depends on whether it is buffering requests (see Section 41.9.3).

If the `_fwd` key is not present in a request context, the mode used by the router to forward that request depends on the mode used by the client's proxy and the router's own configuration. If the client used twoway mode, the router also uses twoway mode. If the client sent the request as a oneway or batch oneway, the

router's behavior is determined by the configuration properties described in Section 41.9.3.

41.9.2 `_ovrd`

In buffered mode, the router allows a new incoming request to override any pending requests that are still in the router's queue, effectively replacing any pending requests with the new request. For a new request to override a pending request, both requests must meet the following criteria:

- they specify the `_ovrd` key in the request context with the same value
- they are oneway requests
- they are requests on the same object.

This feature is intended to be used by clients that are sending frequent oneway requests in which the most recent request takes precedence. This feature minimizes the number of requests that are forwarded to the server when requests are sent frequently enough that they accumulate in the router's queue before the router has a chance to process them.

41.9.3 Batch Requests

Clients can direct the router to forward oneway requests in batches by including the `D` or `O` characters in the `_fwd` context, as described in Section 41.9.1. If the router is configured for buffered mode and several such requests accumulate in its queue, the router forwards them together in a batch rather than as individual requests. See Section 31.15 for more information on batched invocations.

In addition, the properties `Glacier2.Client.AlwaysBatch` and `Glacier2.Server.AlwaysBatch` determine whether oneway requests are always batched regardless of the `_fwd` context. The former property affects requests from clients to servers, while the latter affects requests from servers to clients. If a property is defined with a non-zero value, then all requests whose `_fwd` context includes the `o` character are treated as if `O` were specified instead, and are batched when possible. Likewise, requests whose `_fwd` context includes the `d` character are treated as if `D` were specified.

If a property is not defined, the router does not batch requests unless specifically directed to do so by the `_fwd` context.

41.9.4 Context Forwarding

The configuration properties `Glacier2.Client.ForwardContext` and `Glacier2.Server.ForwardContext` determine whether the router includes the context when forwarding a request. The former property affects requests from clients to servers, while the latter affects requests from servers to clients. If a property is not defined or has the value zero, the router does not include the context when forwarding requests.

41.10 Firewalls

The Glacier2 router requires only one external port to receive connections from clients and therefore can easily coexist with a network firewall device. For example, consider the network shown in Figure 41.7.

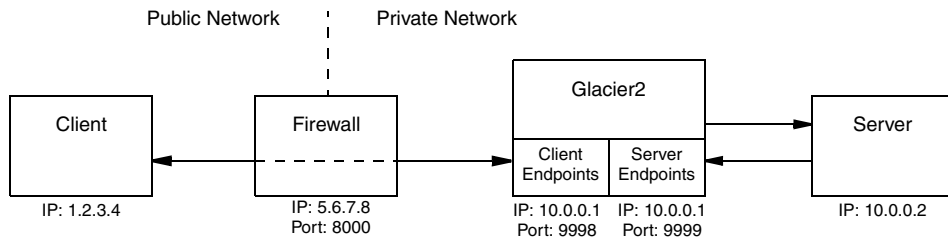

Figure 41.7. Using Glacier2 with a network firewall.

In contrast to Figure 41.6, the Glacier2 router in this example has both of its endpoints in the private network and its host requires only one IP address. We assume that the firewall has been configured to forward connections from port 8000 to the router's client endpoint at port 9998. Meanwhile, the client must be configured to use the firewall's address information in its router proxy, as shown below:

```
Ice.Default.Router=Glacier2/router:ssl -h 5.6.7.8 -p 8000
```

The Glacier2 router configuration for this example requires the following properties:

```
Glacier2.Client.Endpoints=ssl -h 10.0.0.1 -p 9998
Glacier2.Client.PublishedEndpoints=ssl -h 5.6.7.8 -p 8000
Glacier2.Server.Endpoints=tcp -h 10.0.0.1 -p 9999
```

There are two points of interest in this configuration:

1. The `Glacier2.Client.PublishedEndpoints` property is necessary so that any proxies created by the router contain the firewall's addressing information.
2. The server endpoint specifies a fixed port (9999), but the router does not require a fixed port in this endpoint to operate properly.

41.11 Advanced Client Configurations

This section discusses strategies that Glacier2 clients can use to address more advanced requirements.

41.11.1 Object Adapter Strategies

An application that needs to support callback requests from a router as well as requests from local clients should use multiple object adapters. This strategy ensures that proxies created by these object adapters contain the appropriate endpoints. For example, suppose we have the network configuration shown in Figure 41.8. Notice that the two local area networks use the same private network addresses, which is not an unrealistic scenario.

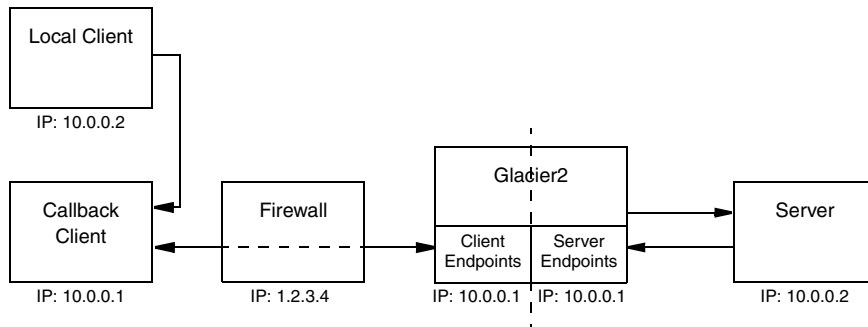

Figure 41.8. Supporting callback and local requests.

Now, if the callback client were to use a single object adapter for handling both callback requests and local requests, then any proxies created by that object adapter would contain the application's local endpoints as well as the router's server endpoints. As you might imagine, this could cause some subtle problems.

1. When the local client attempts to establish a connection to the callback client via one of these proxies, it might arbitrarily select one of the router's server endpoints to try first. Since the router's server endpoints use addresses in the same network, the local client attempts to make a connection over the local network, with two possible outcomes: the connection attempts to those endpoints fail, in which case they are skipped and the real local endpoints are attempted; or, even worse, one of the endpoints might accidentally be valid in the local network, in which case the local client has just connected to some unknown server.
2. The server may encounter similar problems when attempting to establish a local connection to the router in order to make a callback request.

The solution is to dedicate an object adapter solely to handling callback requests, and another one for servicing local clients. The object adapter dedicated to callback requests must be configured with the router proxy as described in Section 41.4.4.

41.11.2 Using Multiple Routers

A client is not limited to using only one router at a time: the proxy operation `ice_router` allows a client to configure its routed proxies as necessary. With respect to callbacks, a client must create a new callback object adapter for each router that can forward callback requests to the client.

For information on configuring multiple routers, see Section 41.3.5.

41.12 IceGrid Integration

IceGrid is a server activation and location service, as described in Chapter 37. This section describes the ways in which you can integrate Glacier2 and IceGrid.

41.12.1 Configuring Clients

It is not uncommon for a Glacier2 client to require access to a locator service such as IceGrid. A locator client would typically define the property `Ice.Default.Locator` with a stringified proxy for the locator service, as described in Section 37.4.4. However, when that locator service is accessed via a Glacier2 router, the configuration requirements are slightly different. It is no

longer necessary for the client to define `Ice.Default.Locator`; this property must be defined in the Glacier2 router's configuration instead.

For example, consider the following network architecture:

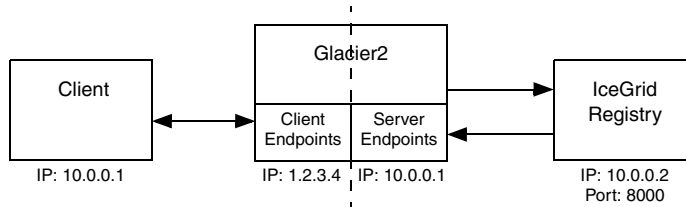

In this case the Glacier2 router's configuration must include the property shown below:

```
Ice.Default.Locator=IceGrid/Locator:tcp -h 10.0.0.2 -p 8000
```

41.12.2 Locator Timeouts

An IceGrid application might want to use replication (see Section 37.8) to increase the availability of Glacier2 session managers. When you configure an indirect proxy for a session manager (and configure Glacier2 with a locator proxy, as described in Section 41.12.1), the Ice run time in the router queries the locator to obtain a proxy for a session manager replica. By default, this proxy is cached for 10 minutes, meaning the router uses the same session manager proxy to create sessions for a 10-minute period, after which it queries the locator again. If you want to distribute the session-creation load among the session manager replicas more evenly, you can decrease the locator cache timeout using configuration properties. For example, the following settings use a timeout of 30 seconds:

```
Glacier2.SessionManager.LocatorCacheTimeout=30
Glacier2.SSLSessionManager.LocatorCacheTimeout=30
```

As you can see, timeouts are specified individually for the `SessionManager` and `SSLSessionManager` proxies. You can also disable caching completely by using a value of 0, in which case the router queries the locator before every invocation on a session manager.

See Section 41.6.3 for more information on connection caching.

41.13 Summary

Complex network environments are a fact of life. Unfortunately, the cost of securing an enterprise's network is increased application complexity and administrative overhead. Glacier2 helps to minimize these costs by providing a low-impact, efficient and secure router for Ice applications.

Chapter 42

IceBox

42.1 Chapter Overview

In this chapter we present IceBox, an easy-to-use framework for Ice application services. Section 42.2 provides an overview of IceBox and the advantages of using it. Section 42.3 introduces the service manager and describes its role in IceBox. A tutorial on writing and configuring an IceBox service is presented in Section 42.4, and Section 42.5 puts all the pieces together.

42.2 Introduction

The Service Configurator pattern [7] is a useful technique for configuring services and centralizing their administration. In practical terms, this means services are developed as dynamically-loadable components that can be configured into a general purpose “super server” in whatever combinations are necessary. IceBox is an implementation of the Service Configurator pattern for Ice services.

A generic IceBox server replaces the typical monolithic Ice server you normally write. The IceBox server is configured via properties with the application-specific services it is responsible for loading and managing, and it can be administered remotely. There are several advantages in using this architecture:

- Services loaded by the same IceBox server can be configured to take advantage of Ice's collocation optimizations. For example, if one service is a client of another service, and those services reside in the same IceBox server, then invocations between them can be optimized.
- Composing an application consisting of various services is done by configuration, not by compiling and linking. This decouples the service from the server, allowing services to be combined or separated as needed.
- Multiple Java services can be active in a single instance of a Java Virtual Machine (JVM). This conserves operating system resources when compared to running several monolithic servers, each in its own JVM.
- Services implement an IceBox service interface, providing a common framework for developers and a centralized administrative facility.
- IceBox support is integrated into IceGrid, the server activation and deployment service (see Section 37.7).

42.3 The Service Manager

In addition to the objects supported by application services, an IceBox server supports an administrative object that implements the `IceBox::ServiceManager` interface (see Appendix B). This object is responsible for loading and initializing the services, as well as performing administrative actions requested by clients. An object adapter is created for this object so that its endpoint(s) can be secured against unauthorized access.

Currently, the administrative capabilities are rather limited:

```
module IceBox {  
  interface ServiceManager {  
    nonmutating Ice::SliceChecksumDict getSliceChecksums();  
    void shutdown();  
  };  
};
```

The `getSliceChecksums` operation returns Slice checksums of the IceBox definitions (see Section 4.20 for more information). The `shutdown` operation terminates the services and shuts down the IceBox server. Additional administrative features may be added in a future release.

42.3.1 Endpoint Configuration

The endpoints for the service manager's object adapter are defined using the `IceBox.ServiceManager.Endpoints` configuration property:

```
IceBox.ServiceManager.Endpoints=tcp -p 10000
```

Since a malicious client could make a denial-of-service attack against the service manager, it is advisable to use SSL endpoints (see Chapter 40), or to secure these endpoints with the proper firewall configuration, or both.

42.3.2 Client Configuration

A client requiring administrative access to the service manager can create a proxy using the endpoints defined by the property described in Section 42.3.1. The default identity of the service manager object is `IceBox/ServiceManager`, but this can be changed using the `IceBox.InstanceName` property (see Section 42.3.4). Therefore, a proxy using the default identity and the endpoint from Section 42.3.1 would be constructed as follows:

```
ServiceManager.Proxy=IceBox/ServiceManager:tcp -p 10000
```

42.3.3 Administrative Utility

An administrative utility is included with `IceBox`. Given the limited capabilities of the `ServiceManager` interface in its present form, it should come as no surprise that the administrative utility also has limited functionality. `IceBox` provides C++ and Java implementations of the utility, with the same usage:

```
Usage: iceboxadmin [options] [command...]  
Options:  
-h, --help           Show this message.  
-v, --version        Display the Ice version.  
  
Commands:  
shutdown             Shutdown the server.
```

The C++ utility is named `iceboxadmin`, while the Java utility is represented by the class `IceBox.Admin`. Both use the `IceBox.ServiceManager.Endpoints` property (see Section 42.3.1) and the `IceBox.InstanceName` property (see Section 42.3.4) to compose the proxy for the service manager object. Typically, the utility is started using the same configuration file as the `IceBox` server (see Section 42.5), but that is not mandatory.

42.3.4 Object Identities

An IceBox service hosts one well-known object, which implements the `IceBox::ServiceManager` interface and has the default identity `IceBox/ServiceManager`. If an application requires the use of multiple IceBox services, it is a good idea to assign unique identities to the well-known objects by configuring the servers with different values for the `IceBox.InstanceName` property, as shown in the following example:

```
IceBox.InstanceName=IceBox1
```

This property changes the category of the object's identity, which becomes `IceBox1/ServiceManager`. The client's configuration must also be changed to reflect the new identity:

```
ServiceManager.Proxy=IceBox1/ServiceManager:tcp -p 10000
```

42.4 Developing a Service

Writing an IceBox service requires implementing one of the IceBox service interfaces. The sample implementations we present in this section implement `IceBox::Service`, shown below:

```
module IceBox {
local interface Service {
    void start(string name,
               Ice::Communicator communicator,
               Ice::StringSeq args);
    void stop();
};
};
```

As you can see, a service needs to implement only two operations, `start` and `stop`. These operations are invoked by the service manager; `start` is called after the service is loaded, and `stop` is called when the IceBox server is shutting down.

The `start` operation is the service's opportunity to initialize itself; this typically includes creating an object adapter and servants. The `name` and `args` parameters supply information from the service's configuration (see Section 42.4.4), and the `communicator` parameter is an `Ice::Communicator` object created by the service manager for use by the service. Depending on the service configuration, this communicator instance may be shared by other services in the same IceBox

server, therefore care should be taken to ensure that items such as object adapters are given unique names.

The stop operation must reclaim any resources used by the service. Generally, a service deactivates its object adapter, and may also need to invoke `waitForDeactivate` on the object adapter in order to ensure that all pending requests have been completed before the clean up process can proceed. The service manager is responsible for destroying the communicator instance that was passed to `start`.

These interfaces are declared as `local` for a reason: they represent a contract between the service manager and the service, and are not intended to be used by remote clients. Any interaction the service has with remote clients is done via servants created by the service.

42.4.1 C++ Service Example

The example we present here is taken from the `demo/IceBox/hello` sample program provided in the Ice distribution.

The class definition for our service is quite straightforward, but there are a few aspects worth mentioning:

```
#include <IceBox/IceBox.h>

#if defined(_WIN32)
#   define HELLO_API __declspec(dllexport)
#else
#   define HELLO_API /**/
#endif

class HELLO_API HelloServiceI : public IceBox::Service {
public:
    virtual void start(const std::string&,
                      const Ice::CommunicatorPtr&,
                      const Ice::StringSeq&);
    virtual void stop();

private:
    Ice::ObjectAdapterPtr _adapter;
};
```

First, we include the `IceBox` header file so that we can derive our implementation from `IceBox::Service`.

Second, the preprocessor definitions are necessary because, on Windows, this service resides in a Dynamic Link Library (DLL), therefore we need to export the class so that the service manager can load it properly.

The member definitions are equally straightforward:

```
#include <Ice/Ice.h>
#include <HelloServiceI.h>
#include <HelloI.h>

using namespace std;

extern "C" {
    HELLO_API IceBox::Service*
    create(Ice::CommunicatorPtr communicator)
    {
        return new HelloServiceI;
    }
}

void
HelloServiceI::start(
    const string& name,
    const Ice::CommunicatorPtr& communicator,
    const Ice::StringSeq& args)
{
    _adapter = communicator->createObjectAdapter(name);
    Ice::ObjectPtr object = new HelloI(communicator);
    _adapter->add(object, communicator->stringToIdentity("hello"));
;
    _adapter->activate();
}

void
HelloServiceI::stop()
{
    _adapter->deactivate();
}
```

You might be wondering about the `create` function we defined. This is the *entry point* for a C++ IceBox service; that is, this function is used by the service manager to obtain an instance of the service, therefore it must have a particular signature. The name of the function is not important, but the function is expected to take a single argument of type `Ice::CommunicatorPtr`, and return a pointer to `IceBox::Service`¹. In this case, we simply return a new instance of `HelloServiceI`. See Section 42.4.4 for more information on entry points.

The `start` method creates an object adapter with the same name as the service, activates a single servant of type `HelloI` (not shown), and activates the object adapter. The `stop` method simply deactivates the object adapter.

This is obviously a trivial service, and yours will likely be much more interesting, but this does demonstrate how easy it is to write an IceBox service. After compiling the code into a shared library or DLL, it can be configured into an IceBox server as described in Section 42.4.4.

42.4.2 Java Service Example

As with the C++ example presented in the previous section, the complete source for the Java example can be found in the `demo/IceBox/hello` directory of the Ice distribution. The class definition for our service looks as follows:

```
public class HelloServiceI extends Ice.LocalObjectImpl
    implements IceBox.Service
{
    public void
    start(String name,
          Ice.Communicator communicator,
          String[] args)
    {
        _adapter = communicator.createObjectAdapter(name);
        Ice.Object object = new HelloI(communicator);
        _adapter.add(object, Ice.Util.stringToIdentity("hello"));
        _adapter.activate();
    }

    public void
    stop()
    {
        _adapter.deactivate();
    }

    private Ice.ObjectAdapter _adapter;
}
```

-
1. A function with C linkage cannot return an object type, such as a smart pointer, therefore the entry point must return a regular pointer value.

First, notice that our class extends `Ice.LocalObjectImpl`. This is one of the few occasions when an Ice developer must implement a local interface (other common cases are object factories and servant locators).

The `start` method creates an object adapter with the same name as the service, activates a single servant of type `HelloI` (not shown), and activates the object adapter. The `stop` method simply deactivates the object adapter.

The service manager requires a service implementation to have a default constructor. This is the *entry point* for a Java IceBox service; that is, the service manager dynamically loads the service implementation class and invokes the default constructor to obtain an instance of the service.

This is obviously a trivial service, and yours will likely be much more interesting, but this does demonstrate how easy it is to write an IceBox service. After compiling the service implementation class, it can be configured into an IceBox server as described in Section 42.4.4.

42.4.3 C# Service Example

The complete source for the C# example can be found in the `demo/IceBox/hello` directory of the Ice distribution. The class definition for our service looks as follows:

```
class HelloServiceI : Ice.LocalObjectImpl, IceBox.Service
{
    public void
    start(string name,
          Ice.Communicator communicator,
          string[] args)
    {
        _adapter = communicator.createObjectAdapter(name);
        _adapter.add(new HelloI(),
                    Ice.Util.stringToIdentity("hello"));
        _adapter.activate();
    }

    public void
    stop()
    {
        _adapter.deactivate();
    }

    private Ice.ObjectAdapter _adapter;
}
```

First, notice that our class derives from `Ice.LocalObjectImpl`. This is one of the few occasions when an Ice developer must implement a local interface (other common cases are object factories and servant locators).

The `start` method creates an object adapter with the same name as the service, activates a single servant of type `HelloI` (not shown), and activates the object adapter. The `stop` method simply deactivates the object adapter.

The service manager requires a service implementation to have a default constructor. This is the *entry point* for a C# IceBox service; that is, the service manager dynamically loads the service implementation class from an assembly and invokes the default constructor to obtain an instance of the service.

This is obviously a trivial service, and yours will likely be much more interesting, but this does demonstrate how easy it is to write an IceBox service. After compiling the service implementation class, it can be configured into an IceBox server as described in Section 42.4.4.

42.4.4 Configuring a Service

A service is configured into an IceBox server using a single property. This property serves several purposes: it defines the name of the service, it provides the service manager with the service entry point, and it defines properties and arguments for the service.

The format of the property is shown below:

```
IceBox.Service.name=entry_point [args]
```

As an example, here is how we could specify a configuration for IceStorm (see Chapter 43), which is implemented as an IceBox service in C++:

```
IceBox.Service.IceStorm=IceStormService,31:createIceStorm
```

The *name* component of the property key is the service name (IceStorm, in this example). This name is passed to the service's `start` operation, and must be unique among all services configured in the same IceBox server. It is possible, though rarely necessary, to load two or more instances of the same service under different names.

The first argument in the property value is the entry point specification. For C++ services, this must have the form *library[version]:symbol*, where *library* is the simple name of the service's shared library or DLL, and *symbol* is the name of the entry point function. By simple name, we mean a name without any platform-specific prefixes or extensions; the service manager adds appropriate decorations depending on the platform. The version is optional. If specified, the version is

embedded in library name. For the above example, under Windows, the library name is `IceStormService31.dll`.² The shared library or DLL must reside in a directory that appears in `PATH` on Windows or `LD_LIBRARY_PATH` on POSIX systems.

For Java services, the entry point is simply the complete class name (including any package) of the service implementation class. The class must reside in the class path of the IceBox server.

The entry point of a C# or Visual Basic .NET service has the form *assembly:class*. The *assembly* component can be specified as the name of a DLL present in `PATH`, or as the full name of an assembly residing in the Global Assembly Cache (GAC), such as `hello, Version=0.0.0.0, Culture=neutral`. The *class* component is the complete class name of the service implementation class.

Any arguments following the entry point specification are examined. If an argument has the form `--name=value`, then it is interpreted as a property definition that appears in the property set of the communicator passed to the service start operation. These arguments are removed, and any remaining arguments are passed to the start operation in the `args` parameter.

C++ Example

Here is an example of a configuration for our C++ example from Section 42.4.1:

```
IceBox.Service.Hello=HelloService:create \  
  --Ice.Trace.Network=1 hello there
```

This configuration results in the creation of a service named `Hello`. The service is expected to reside in `HelloService.dll` on Windows or `libHelloService.so` on Linux, and the entry point function `create` is invoked to create an instance of the service. The argument `--Ice.Trace.Network=1` is converted into a property definition, and the arguments `hello` and `there` become the two elements in the `args` sequence parameter that is passed to the `start` method.

Java Example

Here is an example of a configuration for our Java example from Section 42.4.2:

2. The exact name of the library that is loaded depends on the naming conventions of the platform IceBox executes on. For example, on Apple machines, the library name is `libIceStormService31.dylib`.

```
IceBox.Service.Hello=HelloServiceI \  
  --Ice.Trace.Network=1 hello there
```

This configuration results in the creation of a service named `Hello`. The service is expected to reside in the class `HelloServiceI`. The argument `--Ice.Trace.Network=1` is converted into a property definition, and the arguments `hello` and `there` become the two elements in the `args` sequence parameter that is passed to the `start` method.

C# Example

Here is an example of a configuration for our C# example from Section 42.4.3:

```
IceBox.Service.Hello=helloservice.dll:HelloServiceI \  
  --Ice.Trace.Network=1 hello there
```

This configuration results in the creation of a service named `Hello`. The service is expected to reside in the assembly named `helloservice.dll`, implemented by the class `HelloServiceI`. The argument `--Ice.Trace.Network=1` is converted into a property definition, and the arguments `hello` and `there` become the two elements in the `args` sequence parameter that is passed to the `start` method.

Sharing a Communicator

A service can be configured to share a communicator instance with the service manager using the following property:

```
IceBox.UseSharedCommunicator.name=1
```

The default behavior if this property is not specified is to create a new communicator instance for the service. However, if collocation optimizations between services are desired, then each of those services must be configured for a shared communicator.

Loading Services

By default, the service manager loads the configured services in an undefined order, meaning services in the same `IceBox` server should not depend on one another. If services must be loaded in a particular order, the `IceBox.LoadOrder` property can be used:

```
IceBox.LoadOrder=Service1,Service2
```

In this example, `Service1` is loaded first, followed by `Service2`. Any remaining services are loaded after `Service2`, in an undefined order. Each

service mentioned in `IceBox.LoadOrder` must have a matching `IceBox.Service` property.

42.5 Starting IceBox

Incorporating everything we discussed in the previous sections, we can now configure and start IceBox servers.

42.5.1 Starting the C++ Server

The configuration file for our example C++ service is shown below:

```
IceBox.ServiceManager.Endpoints=tcp -p 10000
IceBox.Service.Hello=HelloService:create
Hello.Endpoints=tcp -p 10001
```

Notice that we define an endpoint for the object adapter created by the `Hello` service.

Assuming these properties reside in a configuration file named `config`, we can start the C++ IceBox server as follows:

```
$ icebox --Ice.Config=config
```

Additional command line options are supported, including those that allow the server to run as a Windows service or Unix daemon. See Section 8.3.2 for more information.

42.5.2 Starting the Java Server

Our Java configuration is nearly identical to the C++ version, except for the entry point specification:

```
IceBox.ServiceManager.Endpoints=tcp -p 10000
IceBox.Service.Hello=HelloServiceI
Hello.Endpoints=tcp -p 10001
```

Assuming these properties reside in a configuration file named `config`, we can start the Java IceBox server as follows:

```
$ java IceBox.Server --Ice.Config=config
```

42.5.3 Starting the C# Server

The configuration file for our example C# service is shown below:

```
IceBox.ServiceManager.Endpoints=tcp -p 10000
IceBox.Service.Hello=helloservice.dll:HelloService
Hello.Endpoints=tcp -p 10001
```

Notice that we define an endpoint for the object adapter created by the `Hello` service.

Assuming these properties reside in a configuration file named `config`, we can start the C# IceBox server as follows:

```
$ iceboxnet --Ice.Config=config
```

42.5.4 Initialization Failure

At startup, an IceBox server inspects its configuration for all properties having the prefix `IceBox.Service.` and initializes each service. If initialization fails for a service, the IceBox server invokes the `stop` operation on any initialized services, reports an error, and terminates.

42.6 Summary

IceBox offers a refreshing change of perspective: developers focus on writing services, not applications. The definition of an application changes as well; using IceBox, an application becomes a collection of discrete services whose composition is determined dynamically by configuration, rather than statically by the linker.

Chapter 43

IceStorm

43.1 Chapter Overview

In this chapter we present IceStorm, an efficient publish/subscribe service for Ice applications. Section 43.2 provides an introduction to IceStorm, while Section 43.3 discusses some basic IceStorm concepts. An overview of the IceStorm Slice interfaces is provided in Section 43.4, and Section 43.5 presents an example IceStorm application. The IceStorm administration tool is described in Section 43.6, and the subject of federation is discussed in Section 43.7. IceStorm's quality of service parameters are defined in Section 43.8. Finally, IceStorm configuration is addressed in Section 43.9.

43.2 Introduction

Applications often need to disseminate information to multiple recipients. For example, suppose we are developing a weather monitoring application in which we collect measurements such as wind speed and temperature from a meteorolog-

ical tower and periodically distribute them to weather monitoring stations. We initially consider using the architecture shown in Figure 43.1.

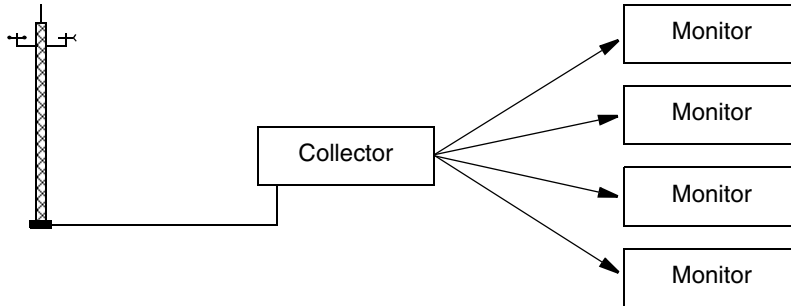

Figure 43.1. Initial design for a weather monitoring application.

However, the primary disadvantage of this architecture is that it tightly couples the collector to its monitors, needlessly complicating the collector implementation by requiring it to manage the details of monitor registration, measurement delivery, and error recovery. We can rid ourselves of these mundane duties by incorporating IceStorm into our architecture, as shown in Figure 43.2.

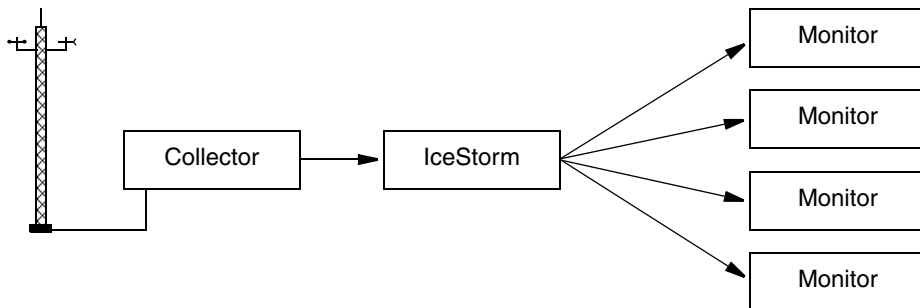

Figure 43.2. A weather monitoring application using IceStorm.

IceStorm simplifies the collector implementation significantly by decoupling it from the monitors. As a publish/subscribe service, IceStorm acts as a mediator between the collector (the publisher) and the monitors (the subscribers), and offers several advantages:

- When the collector is ready to distribute a new set of measurements, it makes a single request to the IceStorm server. The IceStorm server takes responsibility for delivering the request to the monitors, including handling any exceptions caused by ill-behaved or missing subscribers. The collector no longer needs to be aware of its monitors, or whether it even has any monitors at that moment.
- Similarly, monitors interact with the IceStorm server to perform tasks such as subscribing and unsubscribing, thereby allowing the collector to focus on its application-specific responsibilities and not on administrative trivia.
- The collector and monitor applications require very few changes to incorporate IceStorm.

43.3 Concepts

This section discusses several concepts that are important for understanding IceStorm's capabilities.

43.3.1 Message

An IceStorm *message* is strongly typed and is represented by an invocation of a Slice operation: the operation name identifies the type of the message, and the operation parameters define the message contents. A message is published by invoking the operation on an IceStorm proxy in the normal fashion. Similarly, subscribers receive the message as a regular servant upcall. As a result, IceStorm uses the “push” model for message delivery; polling is not supported.

43.3.2 Topic

An application indicates its interest in receiving messages by subscribing to a *topic*. An IceStorm server supports any number of topics, which are created dynamically and distinguished by unique names. Each topic can have multiple publishers and subscribers.

A topic is essentially equivalent to an application-defined Slice interface: the operations of the interface define the types of messages supported by the topic. A publisher uses a proxy for the topic interface to send its messages, and a subscriber implements the topic interface (or an interface derived from the topic interface) in order to receive the messages. This is no different than if the

publisher and subscriber were communicating directly in the traditional client-server style; the interface represents the contract between the client (the publisher) and the server (the subscriber), except IceStorm transparently forwards each message to multiple recipients.

IceStorm does not verify that publishers and subscribers are using compatible interfaces, therefore applications must ensure that topics are used correctly.

43.3.3 Oneway Semantics

IceStorm messages have oneway semantics (see Section 2.2.2), therefore a publisher cannot receive replies from its subscribers. Any of the Ice transports (TCP, SSL, and UDP) can be used to publish and receive messages.

43.3.4 Federation

IceStorm supports the formation of topic graphs, also known as federation. A topic graph is formed by creating links between topics, where a *link* is a unidirectional association from one topic to another. Each link has a *cost* that may restrict message delivery on that link (see Section 43.7.2). A message published on a topic is also published on all of the topic's links for which the message cost does not exceed the link cost.

Once a message has been published on a link, the receiving topic publishes the message to its subscribers, but does not publish it on any of its links. In other words, IceStorm messages propagate at most one hop from the originating topic in a federation (see Section 43.7.1).

Figure 43.3 presents an example of topic federation. Topic T_1 has links to T_2 and T_3 , as indicated by the arrows. The subscribers S_1 and S_2 receive all messages

published on T_2 , as well as those published on T_1 . Subscriber S_3 receives messages only from T_1 , and S_4 receives messages from both T_3 and T_1 .

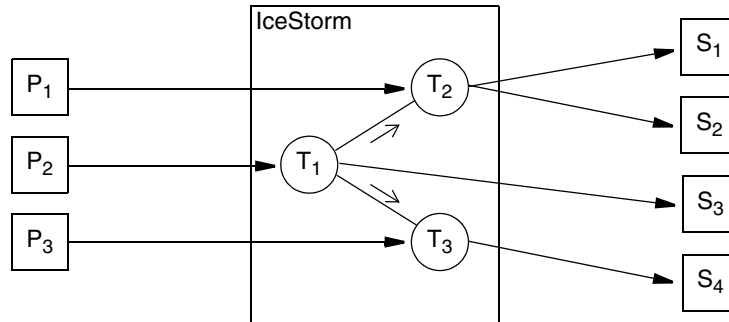

Figure 43.3. Topic federation.

IceStorm makes no attempt to prevent a subscriber from receiving duplicate messages. For example, if a subscriber is subscribed to both T_2 and T_3 , then it would receive two requests for each message published on T_1 .

43.3.5 Quality of Service

IceStorm allows each subscriber to specify its own *quality of service* (QoS) parameters that affect the delivery of its messages. Quality of service parameters are represented as a dictionary of name-value pairs. The supported QoS parameters are described in Section 43.8.

43.3.6 Persistence

IceStorm has a database in which it maintains information about its topics and links. However, a message sent via IceStorm is not stored persistently, but rather is discarded as soon as it is delivered to the topic's current set of subscribers. If an error occurs during delivery to a subscriber, IceStorm does not queue messages for that subscriber.

43.3.7 Subscriber Errors

If IceStorm encounters a failure while attempting to deliver a message to a subscriber, the subscriber is immediately unsubscribed from the topic on which the message was published.

Slow or unresponsive subscribers can also create problems. IceStorm attempts to deliver messages as soon as they are published: when the IceStorm publisher object receives a message, it may immediately make nested invocations to the topic's subscribers. Therefore, if a subscriber is not consuming messages as fast as they are being published, it may cause threads to accumulate in IceStorm. If the number of threads reaches the maximum size of the thread pool (see Section 31.9), then no new messages can be published. You may also want to set a timeout in IceStorm's configuration (using `Ice.Override.Timeout`) so that an unresponsive subscriber does not block the service indefinitely.

43.4 IceStorm Interface Overview

This section provides a brief introduction to the Slice interfaces comprising the IceStorm service. See Appendix B for the Slice documentation.

43.4.1 TopicManager

The `TopicManager` is a singleton object that acts as a factory and repository of `Topic` objects. Its interface and related types are shown below:

```
module IceStorm {
    dictionary<string, Topic*> TopicDict;

    exception TopicExists {
        string name;
    };

    exception NoSuchTopic {
        string name;
    };

    interface TopicManager {
        Topic* create(string name) throws TopicExists;
        nonmutating Topic* retrieve(string name) throws NoSuchTopic;
        nonmutating TopicDict retrieveAll();
        nonmutating Ice::SliceChecksumDict getSliceChecksums();
    };
};
```

The `create` operation is used to create a new topic, which must have a unique name. The `retrieve` operation allows a client to obtain a proxy for an existing

topic, and `retrieveAll` supplies a dictionary of all existing topics. The `getSliceChecksums` operation returns Slice checksums for the IceStorm definitions (see Section 4.20 for more information).

43.4.2 Topic

The `Topic` interface represents a topic and provides several administrative operations for configuring links and managing subscribers.

```

module IceStorm {
  struct LinkInfo {
    Topic* theTopic;
    string name;
    int cost;
  };
  sequence<LinkInfo> LinkInfoSeq;

  dictionary<string, string> QoS;

  exception LinkExists {
    string name;
  };

  exception NoSuchLink {
    string name;
  };

  interface Topic {
    nonmutating string getName();
    nonmutating Object* getPublisher();
    void subscribe(QoS theQoS, Object* subscriber);
    idempotent void unsubscribe(Object* subscriber);
    idempotent void link(Topic* linkTo, int cost)
      throws LinkExists;
    idempotent void unlink(Topic* linkTo) throws NoSuchLink;
    nonmutating LinkInfoSeq getLinkInfoSeq();
    void destroy();
  };
};

```

The `getName` operation returns the name assigned to the topic, while the `getPublisher` operation returns a proxy for the topic's publisher object (see Section 43.5.2).

The `subscribe` operation adds a subscriber's proxy to the topic; if another subscriber proxy already exists with the same object identity, the subscriber's proxy is replaced with the new one. The `unsubscribe` operation removes the subscriber from the topic.

A link to another topic is created using the `link` operation; if a link already exists to the given topic, the `LinkExists` exception is raised. Links are destroyed using the `unlink` operation.

Finally, the `destroy` operation permanently destroys the topic.

43.5 Using IceStorm

In this section we expand on the weather monitoring example from Section 43.2, demonstrating how to create, subscribe to and publish messages on a topic. We use the following Slice definitions in our example:

```
struct Measurement {
    string tower; // tower id
    float windSpeed; // knots
    short windDirection; // degrees
    float temperature; // degrees Celsius
};

interface Monitor {
    void report(Measurement m);
};
```

`Monitor` is our topic interface. For the sake of simplicity, it defines just one operation, `report`, taking a `Measurement` struct as its only parameter.

43.5.1 Implementing a Publisher

The implementation of our collector application can be summarized easily:

1. Obtain a proxy for the `TopicManager`. This is the primary IceStorm object, used by both publishers and subscribers.
2. Obtain a proxy for the `Weather` topic, either by creating the topic if it does not exist, or retrieving the proxy for the existing topic.
3. Obtain a proxy for the `Weather` topic's "publisher object." This proxy is provided for the purpose of publishing messages, and therefore is narrowed to the topic interface (`Monitor`).

4. Collect and report measurements.

In the sections below, we present collector implementations in C++ and Java.

C++ Example

As usual, our C++ example begins by including the necessary header files. The interesting ones are `IceStorm/IceStorm.h`, which is generated from the IceStorm Slice definitions, and `Monitor.h`, containing the generated code for our monitor definitions shown above.

```
#include <Ice/Ice.h>
#include <IceStorm/IceStorm.h>
#include <Monitor.h>

int main(int argc, char* argv[])
{
    ...
    Ice::ObjectPrx obj = communicator->stringToProxy(
        "IceStorm/TopicManager:tcp -p 9999");
    IceStorm::TopicManagerPrx topicManager =
        IceStorm::TopicManagerPrx::checkedCast(obj);
    IceStorm::TopicPrx topic;
    try {
        topic = topicManager->retrieve("Weather");
    }
    catch (const IceStorm::NoSuchTopic&) {
        topic = topicManager->create("Weather");
    }

    Ice::ObjectPrx pub = topic->getPublisher();
    if (!pub->ice_isDatagram())
        pub = pub->ice_oneway();
    MonitorPrx monitor = MonitorPrx::uncheckedCast(pub);
    while (true) {
        Measurement m = getMeasurement();
        monitor->report(m);
    }
    ...
}
```

After obtaining a proxy for the topic manager, the collector attempts to retrieve the topic. If the topic does not exist yet, the collector receives a `NoSuchTopic` exception and then creates the topic.

```

IceStorm::TopicPrx topic;
try {
    topic = topicManager->retrieve("Weather");
}
catch (const IceStorm::NoSuchTopic&) {
    topic = topicManager->create("Weather");
}

```

The next step is obtaining a proxy for the publisher object, which the collector narrows to the `Monitor` interface.

```

Ice::ObjectPrx pub = topic->getPublisher();
if (!pub->ice_isDatagram())
    pub = pub->ice_oneway();
MonitorPrx monitor = MonitorPrx::uncheckedCast(pub);

```

Finally, the collector enters its main loop, collecting measurements and publishing them via the `IceStorm` publisher object.

```

while (true) {
    Measurement m = getMeasurement();
    monitor->report(m);
}

```

Java Example

The equivalent Java version is shown below.

```

public static void main(String[] args)
{
    ...
    Ice.ObjectPrx obj = communicator.stringToProxy(
        "IceStorm/TopicManager:tcp -p 9999");
    IceStorm.TopicManagerPrx topicManager =
        IceStorm.TopicManagerPrxHelper.checkedCast(obj);
    IceStorm.TopicPrx topic = null;
    try {
        topic = topicManager.retrieve("Weather");
    }
    catch (IceStorm.NoSuchTopic ex) {
        topic = topicManager.create("Weather");
    }

    Ice.ObjectPrx pub = topic.getPublisher();
    if (!pub.ice_isDatagram())
        pub = pub.ice_oneway();
    MonitorPrx monitor = MonitorPrxHelper.uncheckedCast(pub);
    while (true) {

```

```

        Measurement m = getMeasurement();
        monitor.report(m);
    }
    ...
}

```

After obtaining a proxy for the topic manager, the collector attempts to retrieve the topic. If the topic does not exist yet, the collector receives a `NoSuchTopic` exception and then creates the topic.

```

IceStorm.TopicPrx topic = null;
try {
    topic = topicManager.retrieve("Weather");
}
catch (IceStorm.NoSuchTopic ex) {
    topic = topicManager.create("Weather");
}

```

The next step is obtaining a proxy for the publisher object, which the collector narrows to the `Monitor` interface.

```

Ice.ObjectPrx pub = topic.getPublisher();
if (!pub.ice_isDatagram())
    pub = pub.ice_oneway();
MonitorPrx monitor = MonitorPrxHelper.uncheckedCast(pub);

```

Finally, the collector enters its main loop, collecting measurements and publishing them via the IceStorm publisher object.

```

while (true) {
    Measurement m = getMeasurement();
    monitor.report(m);
}

```

43.5.2 Using a Publisher Object

Each topic creates a publisher object for the express purpose of publishing messages. It is a special object in that it implements an Ice interface that allows the object to receive and forward requests (i.e., IceStorm messages) without requiring knowledge of the operation types.

Type Safety

From the publisher's perspective, the publisher object appears to be an application-specific type. In reality, the publisher object can forward requests for any type, and that introduces a degree of risk: a misbehaving publisher can use

`uncheckedCast` to narrow the publisher object to any type and invoke any operation; the publisher object unknowingly forwards those requests to the subscribers.

If a publisher sends a request using an incorrect type, the Ice run time in a subscriber typically responds by raising `OperationNotExistException`. However, since the subscriber receives its messages as oneway invocations, no response can be sent to the publisher object to indicate this failure, and therefore neither the publisher nor the subscriber is aware of the type-mismatch problem. In short, IceStorm places the burden on the developer to ensure that publishers and subscribers are using it correctly.

Oneway or Twoway?

IceStorm messages have oneway semantics (see Section 43.3.3), but publishers may use either oneway or twoway invocations when sending messages to the publisher object. Each invocation style has advantages and disadvantages that you should consider when deciding which one to use. The differences between the invocation styles affect a publisher in four ways:

- **Efficiency**

Oneway invocations have the advantage in efficiency because the Ice run time in the publisher does not await a reply to each message.

- **Ordering**

The use of oneway invocations by a publisher may affect the order in which subscribers receive messages. If ordering is important, use twoway invocations (also see Section 43.8.1).

- **Reliability**

Oneway invocations can be lost under certain circumstances, even when they are sent over a reliable transport such as TCP (see Section 31.13). If the loss of messages is unacceptable, or you are unable to address the potential causes of lost oneway messages, then twoway invocations are recommended.

- **Delays**

A publisher may experience network-related delays when sending messages to IceStorm if subscribers are slow in processing messages. Twoway invocations are more susceptible to these delays than oneway invocations.

Transports

Each subscriber can select its own transport for message delivery, therefore the transport used by a publisher to communicate with IceStorm has no effect on how IceStorm delivers messages to its subscribers.

For example, a subscriber may be configured to use a UDP transport if the possibility of lost messages is acceptable. However, the TCP or SSL transports are generally recommended for IceStorm's publisher endpoint in order to ensure that published messages are delivered reliably to IceStorm, even if they may not be delivered reliably to some subscribers.

Request Contexts

A request context is an optional argument of all remote invocations (see Section 31.11). If a publisher supplies a request context when publishing a message, IceStorm will forward it intact to subscribers.

Services such as Glacier2 employ request contexts to provide applications with more control over the service's behavior. For example, if a publisher knows that IceStorm is delivering messages to subscribers via a Glacier2 router, the publisher can influence Glacier2's behavior by including a request context, as shown in the following C++ example:

```
Ice::ObjectPrx pub = topic->getPublisher();
Ice::Context ctx;
ctx["_fwd"] = "Oz";
MonitorPrx monitor =
    MonitorPrx::uncheckedCast(pub->ice_context(ctx));
```

The `_fwd` context key, when encountered by Glacier2, causes the router to forward the request using compressed batch oneway messages. The `ice_context` method is used to obtain a proxy that includes the Glacier2 request context in every invocation, eliminating the need for the publisher to specify it explicitly. See Section 41.9 for more information on Glacier2's use of request contexts.

43.5.3 Implementing a Subscriber

Our subscriber implementation takes the following steps:

1. Obtain a proxy for the `TopicManager`. This is the primary IceStorm object, used by both publishers and subscribers.
2. Create an object adapter to host our `Monitor` servant.

3. Instantiate the `Monitor` servant and activate it with the object adapter.
4. Subscribe to the `Weather` topic.
5. Process report messages until shutdown.
6. Unsubscribe from the `Weather` topic.

In the sections below, we present monitor implementations in C++ and Java.

C++ Example

Our C++ monitor implementation begins by including the necessary header files. The interesting ones are `IceStorm/IceStorm.h`, which is generated from the `IceStorm` Slice definitions, and `Monitor.h`, containing the generated code for our monitor definitions shown at the beginning of Section 43.2.

```
#include <Ice/Ice.h>
#include <IceStorm/IceStorm.h>
#include <Monitor.h>

using namespace std;

class MonitorI : virtual public Monitor {
public:
    virtual void report(const Measurement& m,
                       const Ice::Current&) {
        cout << "Measurement report:" << endl
              << "  Tower: " << m.tower << endl
              << "  W Spd: " << m.windSpeed << endl
              << "  W Dir: " << m.windDirection << endl
              << "  Temp: " << m.temperature << endl
              << endl;
    }
};

int main(int argc, char* argv[])
{
    ...
    Ice::ObjectPrx obj = communicator->stringToProxy(
        "IceStorm/TopicManager:tcp -p 9999");
    IceStorm::TopicManagerPrx topicManager =
        IceStorm::TopicManagerPrx::checkedCast(obj);

    Ice::ObjectAdapterPtr adapter =
        communicator->createObjectAdapter("MonitorAdapter");

    MonitorPtr monitor = new MonitorI;
```



```

Ice::ObjectPrx proxy = adapter->addWithUUID(monitor);

IceStorm::TopicPrx topic;
try {
    topic = topicManager->retrieve("Weather");
    IceStorm::QoS qos;
    topic->subscribe(qos, proxy);
}
catch (const IceStorm::NoSuchTopic&) {
    // Error! No topic found!
    ...
}

adapter->activate();
communicator->waitForShutdown();

topic->unsubscribe(proxy);
...
}

```

Our implementation of the `Monitor` servant is currently quite simple. A real implementation might update a graphical display, or incorporate the measurements into an ongoing calculation.

```

class MonitorI : virtual public Monitor {
public:
    virtual void report(const Measurement& m,
                       const Ice::Current&) {
        cout << "Measurement report:" << endl
              << "  Tower: " << m.tower << endl
              << "  W Spd: " << m.windSpeed << endl
              << "  W Dir: " << m.windDirection << endl
              << "  Temp: " << m.temperature << endl
              << endl;
    }
};

```

After obtaining a proxy for the topic manager, the program creates an object adapter, instantiates the `Monitor` servant and activates it.

```

Ice::ObjectAdapterPtr adapter =
    communicator->createObjectAdapter("MonitorAdapter");

MonitorPtr monitor = new MonitorI;
Ice::ObjectPrx proxy = adapter->addWithUUID(monitor);

```

Next, the monitor subscribes to the topic.

```

IceStorm::TopicPrx topic;
try {
    topic = topicManager->retrieve("Weather");
    IceStorm::QoS qos;
    topic->subscribe(qos, proxy);
}
catch (const IceStorm::NoSuchTopic&) {
    // Error! No topic found!
    ...
}

```

Finally, the monitor activates its object adapter and waits to be shutdown. After `waitForShutdown` returns, the monitor cleans up by unsubscribing from the topic.

```

adapter->activate();
communicator->waitForShutdown();

topic->unsubscribe(proxy);

```

Java Example

The Java implementation of the monitor is shown below.

```

class MonitorI extends _MonitorDisp {
    public void report(Measurement m, Ice.Current curr) {
        System.out.println(
            "Measurement report:\n" +
            "  Tower: " + m.tower + "\n" +
            "  W Spd: " + m.windSpeed + "\n" +
            "  W Dir: " + m.windDirection + "\n" +
            "  Temp: " + m.temperature + "\n");
    }
}

public static void main(String[] args)
{
    ...
    Ice.ObjectPrx obj = communicator.stringToProxy(
        "IceStorm/TopicManager:tcp -p 9999");
    IceStorm.TopicManagerPrx topicManager =
        IceStorm.TopicManagerPrxHelper.checkedCast(obj);

    Ice.ObjectAdapterPtr adapter =
        communicator.createObjectAdapter("MonitorAdapter");

    Monitor monitor = new MonitorI();

```

```

Ice.ObjectPrx proxy = adapter.addWithUUID(monitor);

IceStorm.TopicPrx topic = null;
try {
    topic = topicManager.retrieve("Weather");
    java.util.Map qos = null;
    topic.subscribe(qos, proxy);
}
catch (IceStorm.NoSuchTopic ex) {
    // Error! No topic found!
    ...
}

adapter.activate();
communicator.waitForShutdown();

topic.unsubscribe(proxy);
...
}

```

Our implementation of the `Monitor` servant is currently quite simple. A real implementation might update a graphical display, or incorporate the measurements into an ongoing calculation.

```

class MonitorI extends _MonitorDisp {
    public void report(Measurement m, Ice.Current curr) {
        System.out.println(
            "Measurement report:\n" +
            " Tower: " + m.tower + "\n" +
            " W Spd: " + m.windSpeed + "\n" +
            " W Dir: " + m.windDirection + "\n" +
            " Temp: " + m.temperature + "\n");
    }
}

```

After obtaining a proxy for the topic manager, the program creates an object adapter, instantiates the `Monitor` servant and activates it.

```

Monitor monitor = new MonitorI();
Ice.ObjectPrx proxy = adapter.addWithUUID(monitor);

```

Next, the monitor subscribes to the topic.

```

IceStorm.TopicPrx topic = null;
try {
    topic = topicManager.retrieve("Weather");
    java.util.Map qos = null;

```

```

        topic.subscribe(qos, proxy);
    }
    catch (IceStorm.NoSuchTopic ex) {
        // Error! No topic found!
        ...
    }

```

Finally, the monitor activates its object adapter and waits to be shutdown. After `waitForShutdown` returns, the monitor cleans up by unsubscribing from the topic.

```

adapter.activate();
communicator.waitForShutdown();

topic.unsubscribe(proxy);

```

43.6 IceStorm Administration

The IceStorm administration tool is a command-line program that provides administrative control of an IceStorm server. The tool requires that the `IceStorm.TopicManager.Proxy` property be specified as described in Section 43.9.2.

The following command-line options are supported:

```

$ icestormadmin -h
Usage: icestormadmin [options] [file...]
Options:
-h, --help           Show this message.
-v, --version        Display the Ice version.
-DNAME               Define NAME as 1.
-DNAME=DEF           Define NAME as DEF.
-UNAME               Remove any definition for NAME.
-IDIR                Put DIR in the include file search path.
-e COMMANDS          Execute COMMANDS.
-d, --debug          Print debug messages.

```

The tool operates in three modes, depending on the command-line arguments:

1. If one or more `-e` options are specified, the tool executes the given commands and exits.
2. If one or more files are specified, the tool preprocesses each file with the C preprocessor, executes the commands in each file, and exits.
3. Otherwise, the tool enters an interactive session.

The **help** command displays the following usage information:

help

Print this message.

exit, quit

Exit this program.

create TOPICS

Add TOPICS.

destroy TOPICS

Remove TOPICS.

link FROM TO COST

Link FROM to TO with the given COST.

unlink FROM TO

Unlink TO from FROM.

graph DATA COST

Construct the link graph as described in DATA with COST.

list [TOPICS]

Display information on TOPICS or all topics.

Many of the commands accept one or more topic names (**TOPICS**) as arguments. Topic names containing white space or matching a command keyword must be enclosed in single or double quotes.

For more information on the **graph** command, see Section 43.7.3.

43.7 Topic Federation

The ability to link topics together into a federation provides IceStorm applications with a lot of flexibility, while the notion of a “cost” associated with links allows applications to restrict the flow of messages in creative ways. IceStorm applications have complete control of topic federation using the `TopicManager` interface described in Appendix B, allowing links to be created and removed dynamically

as necessary. For many applications, however, the topic graph is static and therefore can be configured using the administrative tool discussed in Section 43.6.

43.7.1 Message Propagation

IceStorm messages are never propagated over more than one link. For example, consider the topic graph shown in Figure 43.4.

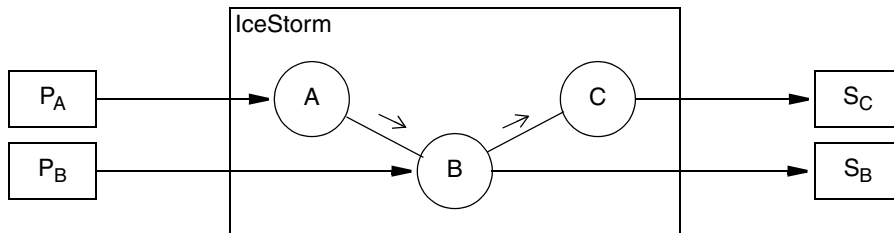

Figure 43.4. Message propagation.

In this case, messages published on A are propagated to B, but B does not propagate A's messages to C. Therefore, subscriber S_B receives messages published on topics A and B, but subscriber S_C only receives messages published on topics B and C. If the application needs messages to propagate from A to C, then a link must be established directly between A and C.

43.7.2 Cost

As described in Section 43.7.1, IceStorm messages are only propagated on the originating topic's immediate links. In addition, applications can use the notion of cost to further restrict message propagation.

A cost is associated with messages and links. When a message is published on a topic, the topic compares the cost associated with each of its links against the message cost, and only propagates the message on those links whose cost equals or exceeds the message cost. A cost value of zero (0) has the following implications:

- messages with a cost value of zero (0) are published on all of the topic's links regardless of the link cost;
- links with a cost value of zero (0) accept all messages regardless of the message cost.

For example, consider the topic graph shown in Figure 43.5.

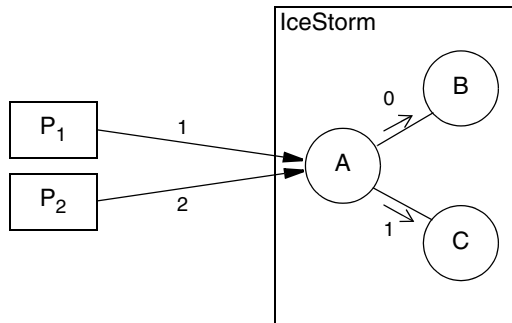

Figure 43.5. Cost semantics.

Publisher P_1 publishes a message on topic A with a cost of 1. This message is propagated on the link to topic B because the link has a cost of 0 and therefore accepts all messages. The message is also propagated on the link to topic C, because the message cost does not exceed the link cost (1). On the other hand, the message published by P_2 with a cost of 2 is only propagated on the link to B.

Request Context

The cost of a message is specified in an Ice request context. Each Ice proxy operation has an implicit argument of type `Ice::Context` representing the request context (see Section 31.11). This argument is rarely used, but it is the ideal location for specifying the cost of an IceStorm message because an application only needs to supply a request context if it actually uses IceStorm's cost feature. If the request context does not contain a cost value, the message is assigned the default cost value of zero (0).

Publishing a Message with a Cost

The code examples below demonstrate how a collector can publish a measurement with a cost value of 5. First, the C++ version:

```
Measurement m = getMeasurement();
Ice::Context ctx;
ctx["cost"] = "5";
monitor->report(m, ctx);
```

And here is the equivalent version in Java:

```

Measurement m = getMeasurement();
java.util.HashMap ctx = new java.util.HashMap();
ctx.put("cost", "5");
monitor.report(m, ctx);

```

Receiving a Message with a Cost

A subscriber can discover the cost of a message by examining the request context supplied in the `Ice::Current` argument. For example, here is a C++ implementation of `Monitor::report` that displays the cost value if it is present:

```

virtual void report(const Measurement& m,
                   const Ice::Current& curr) {
    Ice::Context::const_iterator p = curr.ctx.find("cost");
    cout << "Measurement report:" << endl
         << "  Tower: " << m.tower << endl
         << "  W Spd: " << m.windSpeed << endl
         << "  W Dir: " << m.windDirection << endl
         << "  Temp: " << m.temperature << endl
         << "  Temp: " << m.temperature << endl;
    if (p != curr.ctx.end())
        cout << "    Cost: " << p->second << endl;
    cout << endl;
}

```

And here is the equivalent Java implementation:

```

public void report(Measurement m, Ice.Current curr) {
    String cost = null;
    if (curr.ctx != null)
        cost = curr.ctx.get("cost");
    System.out.println(
        "Measurement report:\n" +
        "  Tower: " + m.tower + "\n" +
        "  W Spd: " + m.windSpeed + "\n" +
        "  W Dir: " + m.windDirection + "\n" +
        "  Temp: " + m.temperature);
    if (cost != null)
        System.out.println("    Cost: " + cost);
    System.out.println();
}

```

For the sake of efficiency, the Ice for Java run time may supply a null value for the request context in `Ice.Current`, therefore an application is required to check for null before using the request context. Furthermore, a non-null request context

is subject to change after the completion of the request, so an application that wishes to retain the request context must make a copy of it (e.g., using `clone`).

43.7.3 Automating Federation

Given the restrictions on message propagation described in the previous sections, creating a complex topic graph can be a tedious endeavor. Of course, creating a topic graph is not typically a common occurrence, since IceStorm keeps a persistent record of the graph. However, there are situations where an automated procedure for creating a topic graph can be valuable, such as during development when the graph might change significantly and often, or when graphs need to be recomputed based on changing costs.

Administration Tool Script

A simple way to automate the creation of a topic graph is to create a text file containing commands to be executed by the IceStorm administration tool. For example, the commands to create the topic graph shown in Figure 43.5 are shown below:

```
create A B C
link A B 0
link A C 1
```

If we store these commands in the file `graph.txt`, we can execute them using the following command:

```
$ icestormadmin --Ice.Config=config graph.txt
```

We assume that the configuration file `config` contains the definition for the property `IceStorm.TopicManager.Proxy`.

XML Graph Descriptor

IceStorm provides an alternative method of configuring topic graphs for applications that use message and link costs. This feature is employed using the administration tool's **graph** command, which accepts an XML graph descriptor and

establishes links between topics based on reachability within a maximum cost. For example, let us start with the graph shown in Figure 43.6.

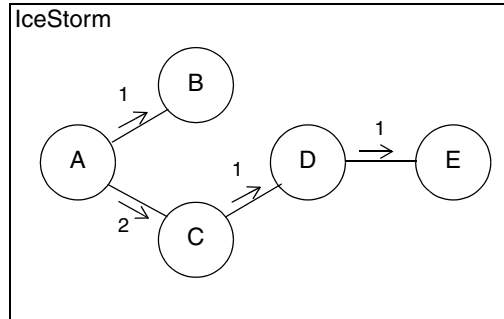

Figure 43.6. Initial graph.

The XML graph descriptor for this topic graph is shown below.

```

<?xml version="1.0" encoding="iso-8859-1"?>
<graph>
  <vertex-set>
    <vertex name="A"/>
    <vertex name="B"/>
    <vertex name="C"/>
    <vertex name="D"/>
    <vertex name="E"/>
  </vertex-set>
  <edge-set>
    <edge source="A" target="B" cost="1"/>
    <edge source="A" target="C" cost="2"/>
    <edge source="C" target="D" cost="1"/>
    <edge source="D" target="E" cost="1"/>
  </edge-set>
</graph>

```

As you can see, the descriptor format is quite straightforward. The outer graph element contains one vertex-set element and one edge-set element. The vertex-set element is comprised of two or more vertex elements having a single attribute, name, providing the name of a topic. The edge-set element contains one or more edge elements that describe links between topics. The source and target attributes supply the topic names, and the cost attribute defines the link cost.

Although this descriptor accurately describes the structure of the graph in Figure 43.6, the graph that is ultimately created by the administration tool's **graph** command is dependent on the specified maximum cost. Suppose we save our graph descriptor as `graph.xml` and execute the following commands:

```
$ icestormadmin --Ice.Config=config
>>> create A B C
>>> graph "graph.xml" 1
```

We must first create the topics that are used as vertices in our XML graph descriptor. Next, we instruct the administration tool to create a graph using a maximum cost of 1, which results in the graph shown in Figure 43.7.

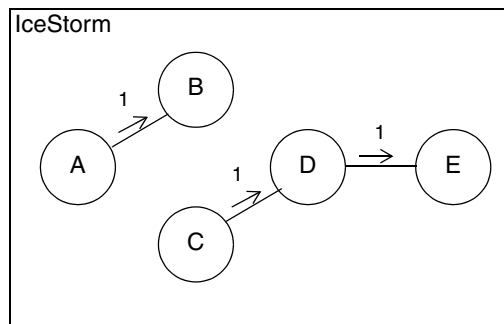

Figure 43.7. Graph with maximum cost of 1.

Notice that the link from A to C was not created, because the cost of that link (2) exceeded the maximum cost. Now consider the outcome of using a maximum cost of 2:

```
>>> graph "graph.xml" 2
```

As shown in Figure 43.8, the link from A to C is now present. In addition, a link from C to E has been established with a cost of 2, because E is reachable from C within the maximum cost.

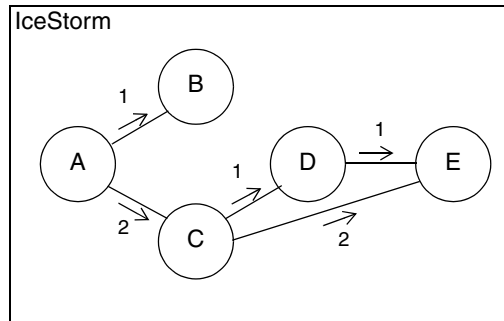

Figure 43.8. Graph with maximum cost of 2.

We can verify that the links are created properly using the **list** command:

```

>>> list A B C D E
A
  B with cost 0
  C with cost 2
B
C
  D with cost 1
  E with cost 2
D
  E with cost 1
E
  
```

The **graph** command can be used repeatedly to experiment with different cost configurations. For each invocation of the **graph** command, the administration tool recomputes the graph based on the specified maximum cost, establishes the necessary links, and removes any links that are no longer valid given the new cost constraints.

43.8 Quality of Service

An IceStorm subscriber specifies QoS parameters at the time of subscription. IceStorm currently supports only one QoS parameter, `reliability`, which is described in the section below.

43.8.1 Reliability

The QoS parameter `reliability` affects message delivery. The legal values for this parameter are `oneway`, `batch`, `twoway` and `twoway ordered`. If not specified, the default value is `oneway`.

oneway and batch

In the `oneway` reliability mode, each published message results in a separate `oneway` invocation to the subscriber. Specifying the value `batch` causes much different behavior: IceStorm temporarily queues messages for the subscriber and flushes them at regular intervals by delivering them as `batch oneway` requests (see Section 31.15). There is no difference between the two reliability modes as far as the subscriber's servant implementation is concerned; the messages are delivered individually as servant up-calls in the normal fashion. However, there is a difference in terms of safety and performance.

The `oneway` mode emphasizes safety by delivering its messages as soon as they are received in order to minimize the possibility of lost messages should an IceStorm failure occur.

By contrast, the `batch` mode queues messages for a configurable amount of time, increasing the possibility of lost messages in the event of failure, but providing better performance by minimizing network overhead. The frequency with which the `batch` mode flushes its queues is determined by the configuration property `IceStorm.Flush.Timeout`, as described in Appendix C.

The performance improvement offered by the `batch` mode is especially apparent for topics in which small messages are sent frequently. Rather than making many small requests, as would be done in `oneway` mode, the messages are accumulated and delivered in groups, amortizing the network overhead across several messages. However, the subscriber should only use the `batch` mode if it is willing to wait up to the flush timeout for new messages.

Both modes are susceptible to lost messages when a connection is closed. For this reason, server-side active connection management (which is disabled by default) should not be used. Section 35.6.2 discusses this issue in detail.

If `batch` mode is used, the messages are relatively large, and the flush timeout is too long, it is possible that the accumulated batch request could exceed the Ice run time's maximum message size and cause the messages to be discarded. In this situation you would need to flush the batch request more frequently by decreasing the flush timeout, or increase the maximum message size by setting `Ice.MessageSizeMax` to a larger value.

twoway

The `twoway` reliability mode uses twoway invocations between IceStorm and the subscriber, but makes no guarantees about the order in which messages are delivered. If maintaining message order is important, see the description of the `twoway ordered` mode below.

When IceStorm receives a new message from a publisher, the `twoway` mode causes the service to immediately forward that message to the subscriber as a twoway invocation. This mode is similar to `oneway`, with the advantage that a subscriber could safely enable server-side active connection management (see Section 35.4) to conserve resources without the risk of lost messages.

twoway ordered

The `twoway ordered` reliability mode uses twoway invocations between IceStorm and the subscriber. Furthermore, this mode guarantees that the subscriber receives messages in the order they were received by the service.

Upon receipt of a new message from a publisher, the `twoway ordered` mode causes IceStorm to immediately deliver the message to the subscriber, but only if no other message is currently being delivered to that subscriber. Otherwise, the message is queued and delivered as soon as all preceding messages are sent. This internal queue makes publishers less susceptible to subscriber delays, but a slow subscriber can cause messages to accumulate in the service.

Notice that `twoway ordered` does *not* guarantee that a subscriber receives messages from the same publisher in the order they were sent by that publisher. The order in which IceStorm processes invocations from the same publisher depends on several factors, such as whether the publisher uses `oneway` or `twoway` invocations, and the threading model configured for the IceStorm service.

Messages can be delivered to subscribers out of order if a publisher uses `oneway` invocations, as described in Section 31.13. This is not a concern when the publisher uses `twoway` invocations because there is no possibility that IceStorm can process those invocations out of order. In many cases, the best compromise to guarantee the order of messages from the same publisher is to use `twoway` invoca-

tions between the publisher and IceStorm, and the `twoway` ordered quality of service for the subscriber.

43.8.2 Example

The Slice type `IceStorm::QoS` is defined as a dictionary whose key and value types are both `string`, therefore the QoS parameter name and value are both represented as strings. The example code presented in Section 43.5.3 used an empty dictionary for the QoS argument, meaning default values are used. The C++ and Java examples shown below illustrate how to set the `reliability` parameter to `batch`.

C++ Example

```
IceStorm::QoS qos;  
qos["reliability"] = "batch";  
topic->subscribe(qos, proxy);
```

Java Example

```
java.util.Map qos = new java.util.HashMap();  
qos.put("reliability", "batch");  
topic.subscribe(qos, proxy);
```

43.9 Configuring IceStorm

IceStorm is a relatively lightweight service in that it requires very little configuration and is implemented as an IceBox service (see Chapter 42). The configuration properties supported by IceStorm are described in Appendix C; however, most of them control diagnostic output and are not discussed in this chapter.

43.9.1 Server Configuration

The sample server configuration file shown below presents the properties of primary interest:

```
IceBox.Service.IceStorm=IceStormService,31:createIceStorm  
Freeze.DbEnv.IceStorm.DbHome=db  
IceStorm.TopicManager.Endpoints=tcp -p 9999  
IceStorm.Publish.Endpoints=tcp
```

The first property defines the entry point for the IceStorm service. The service name (the last component of the `IceBox.Service` property name, `IceStorm` in this example) determines the prefix for the IceStorm configuration properties. It is not mandatory to use `IceStorm` as the service name, but it is recommended if there is no preferred name.

IceStorm uses Freeze to manage the service's persistent state, therefore the second property specifies the pathname of the Freeze database environment directory (see Chapter 38) for the service. In this example, the directory `db` is used, which must already exist in the current working directory.

The final two properties specify the endpoints used by the IceStorm object adapters; notice that their property names begin with `IceStorm`, matching the service name. The `TopicManager` property specifies the endpoints on which the `TopicManager` and `Topic` objects reside; these endpoints typically use a connection-oriented protocol such as TCP or SSL. The `Publish` property specifies the endpoints used by topic publisher objects.

43.9.2 Client Configuration

Clients of the service can define a proxy for the `TopicManager` object as follows:

```
IceStorm.TopicManager.Proxy=IceStorm/TopicManager:tcp -p 9999
```

The name of the property is not relevant, but the endpoint must match that of the `IceStorm.TopicManager.Endpoints` property, and the object identity must use the IceStorm service name as the identity category and `TopicManager` as the identity name.

43.9.3 Object Identities

IceStorm hosts one well-known object, which implements the `IceStorm::TopicManager` interface. The default identity of this object is `IceStorm/TopicManager`, as seen in the stringified proxy example from Section 43.9.2. If an application requires the use of multiple IceStorm services, it is a good idea to assign unique identities to the well-known objects by configuring the services with different values for the `IceStorm.InstanceName` property, as shown in the following example:

```
IceStorm.InstanceName=Measurement
```

This property changes the category of the object's identity, which becomes `Measurement/TopicManager`. The client's configuration must also be changed to reflect the new identity:

```
IceStorm.TopicManager.Proxy=Measurement/TopicManager:tcp -p 9999
```

43.10 Summary

IceStorm is a publish/subscribe service that offers Ice applications a flexible and efficient means of publishing oneway requests to a group of subscribers. IceStorm simplifies development by relieving the application from the burden of managing subscribers and handling delivery errors, allowing the application to focus on publishing its data and not on the minutiae of distribution. Finally, IceStorm leverages Ice request-forwarding facilities in order to provide a typed interface to publishers and subscribers, minimizing the impact on applications.

Chapter 44

IcePatch2

44.1 Chapter Overview

This chapter presents IcePatch2,¹ the Ice solution for secure replication of a directory tree. Section 44.2 provides an overview of IcePatch2 concepts and operation, and Sections 44.3 to 44.5 discuss how to prepare a file set and how to run the IcePatch2 client and server. Section 44.6 shows how to configure multiple IcePatch2 servers, and Section 44.7 describes the creation of a custom IcePatch2 client.

44.2 Introduction

IcePatch2 is an efficient file patching service that is easy to configure and use. It includes the following components:

- the IcePatch server (**icepatch2server**)
- a text-based IcePatch client (**icepatch2client**)

1. IcePatch2 supersedes IcePatch, which was a previous version of this service.

- a text-based tool to compress files and calculate checksums (**icepatch2calc**)
- a Slice API and C++ convenience library for developing custom IcePatch2 clients

As with all Ice services, IcePatch2 can be configured to use Ice facilities such as Glacier2 for firewall support and IceSSL for secure communication.

IcePatch2 is conceptually quite simple. The server is given responsibility for a file system directory (the *data directory*) containing the files and subdirectories that are to be distributed to IcePatch2 clients. You use **icepatch2calc** to compress these files and to create a file that contains a checksum for each file. The server transmits the compressed files to the client, which recreates the data directory and its contents on the client side, patching any files that have changed since the previous run.

IcePatch2 is efficient: transfer rates for files are comparable to what you would get using **ftp**.

44.3 Using **icepatch2calc**

Suppose we have the directories and files shown in Figure 44.1 in the data directory on the server side.

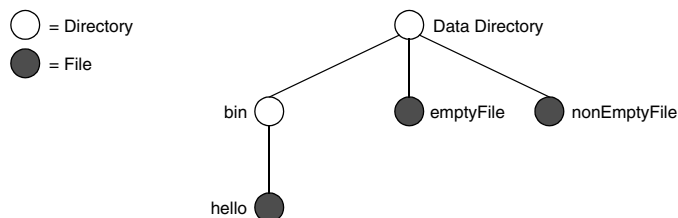

Figure 44.1. An example data directory.

Assume that the file named `emptyFile` is empty (contains zero bytes) and that the remaining files contain data.

To prepare this directory for the transmission by the server, you must first run **icepatch2calc**. (The command shown assumes that the data directory is the current directory.)

```
$ icepatch2calc .
```

After running this command, the contents of the data directory are as shown in Figure 44.2.

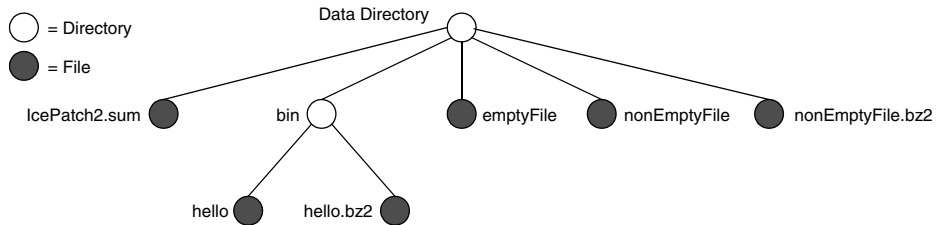

Figure 44.2. Contents of the data directory after running `icepatch2calc`.

Note that `icepatch2calc` compresses the files in the data directory (except for `emptyFile`, which is not compressed). Also note that `icepatch2calc` creates an additional file, `IcePatch2.sum` in the data directory. The contents of this file are as follows:

```

. 3a52ce780950d4d969792a2559cd519d7ee8c727 -1
./bin bd362140a3074eb3edb5e4657561e029092c3d91 -1
./bin/hello 77b11db586a1f20aab8553284241bb3cd532b3d5 70
./emptyFile 082c37fc2641db68d195df83844168f8a464eada 0
./nonEmptyFile aec7301c408e6ce184ae5a34e0ea46e0f0563746 72

```

Each line in the checksum file contains the name of the *uncompressed* file or directory (relative to the data directory), a checksum, and a byte count. For directories, the count is `-1`; for uncompressed files, the count is `0`; for compressed files, the count is the number of bytes in the *compressed* file. The lines in the file are sorted alphabetically by their pathname.

If you add files or delete files from the data directory or make changes to existing files, you must stop the server, run `icepatch2calc` again to update the `IcePatch2.sum` checksum file, and restart the server.

44.3.1 `icepatch2calc` Options

`icepatch2calc` has the following syntax:

```
icepatch2calc [options] data_dir [file...]
```

Normally, you will run `icepatch2calc` by simply specifying a data directory, in which case the program traverses the data directory, compresses all files, and creates an entry in the checksum file for each file and directory.

You can also nominate specific files or directories on the command line. In this case, **icepatch2calc** only compresses and calculates checksums for the specified files and directories. This is useful if you have a very large file tree and want to refresh the checksum entries for only a few selected files or directories that you have updated. (In this case, the program does not traverse the data directory and, therefore, will also not detect any updated, added, or deleted files, except in any of the specified directories.) Any file or directory names you specify on the command line must either be pathnames relative to the data directory or, if you use absolute pathnames, those pathnames must have the data directory as a prefix.

The command supports the following options:

- **-h, --help**

Displays a help message.

- **-v, --version**

Displays the version number.

- **-z, --compress**

Normally, **icepatch2calc** scans the data directory and compresses a file only if no compressed version exists, or if the compressed version of a file has a modification time that predates that of the uncompressed version. If you specify **-z**, the tool re-scans and recompresses the entire data directory, regardless of the time stamps on files. This option is useful if you suspect that time stamps in the data directory may be incorrect.

- **-Z, --no-compress**

This option allows you to create a client-side checksum file.

Do not use this option when creating the checksum file for the server—the option is for creating a client-side `IcePatch2.sum` file for incremental updates (see page 1468).

- **-i, --case-insensitive**

This option disallows file names that differ only in case. (An error message will be printed if **icepatch2calc** encounters any files that differ in case only.) This is in particular useful for Unix servers with Windows clients, since Windows folds the case of file names, and therefore such files would override each other on the Windows client.

- **-V, --verbose**

This option prints a progress message for each file that is compressed and for each checksum that is computed.

44.4 Running the Server

Once you have run `icepatch2calc` on the data directory, you can start the `icepatch2server`:

```
$ icepatch2server .
```

The server expects the data directory as its single command-line argument. If you omit to specify the data directory, the server uses the setting of the `IcePatch2.Directory` property (see Appendix C) to determine the data directory.

The server has two different sets of endpoints, one for regular operations, and one for administration:

- `IcePatch2.Endpoints`

This property determines the endpoint at which the server listens for client requests. This property must be specified.

- `IcePatch2.Admin.Endpoints`

If this property is not set, the only way to shut down the server is to kill it somehow, such as by interrupting the server from the command line. If this property is set, the server offers an additional interface with a shutdown operation, allowing clients to remotely stop the server. Typically, you would set this property to a port that is not accessible to potentially hostile clients.

44.4.1 `icepatch2server` Options

Regardless of whether you run the server under Windows or a UNIX-like operating system, it provides the following options:

- `-h, --help`
Displays a help message.
- `-v, --version`
Displays a version number.

In addition, the server supports the following options under Windows:

- `--service name`
Run as the Windows service *name*.

- **--install *name* [--display *disp*] [--executable *exec*] [*args*]**

Install as Windows service *name*. If *disp* is provided, use it as the display name, otherwise use *name*. If *exec* is provided, use it as the service executable. Any additional arguments are passed unchanged to the service at startup.

- **--uninstall *name***

Uninstall the Windows service *name*.

- **--start *name* [*args*]**

Start the Windows service *name*. Any additional arguments are passed unchanged to the service.

- **--stop *name***

Stop the Windows service *name*.

For UNIX-like operating systems, the server supports the following additional options:

- **--daemon**

Make the server a UNIX daemon process.

- **--noclose**

Do not close the standard file descriptors (*stdin*, *stdout*, and *stderr*).

44.5 Running the Client

Once the `icepatch2server` is running, you can use `icepatch2client` to get a copy of the data directory that is maintained by the server. For example:

```
$ icepatch2client --IcePatch2.Endpoints="tcp -h somehost.com \  
> -p 10000" .
```

The client expects the data directory as its single command-line argument. As for the server, you must specify the `IcePatch2.Endpoints` property so the client knows where to find the server.

If you have not run the client previously, it asks you whether you want to do a thorough patch. You must reply “yes” at this point (or run the client with the `-t` option—see page 1467). The client then goes through the following steps:

1. It traverses the local data directory and creates a local `IcePatch2.sum` checksum file.

2. It obtains the relevant list of checksums from the server and compares it to the list of checksums it has built locally:
 1. The client deletes each file that appears in the local checksum file but not in the server's file.
 2. The client retrieves every file that appears in the server's checksum file, but not in the local file.
 3. The client patches every file that, locally, has a checksum that differs from the corresponding checksum on the server side.

When the client finishes, the contents of the data directory on the client side exactly match the contents of the data directory on the server side. However, only the uncompressed files are created on the client side—the server stores the compressed version of the files simply to avoid redundantly compressing a file every time it is retrieved by a client.

Using `icepatch2client` for Partial Updates

Once you have run the client, the client-side data directory contains an `IcePatch2.sum` file that reflects the contents of the data directory. If you run `icepatch2client` a second time, the program uses the contents of the local checksum file: for each entry in the local checksum file, the client compares the local checksum with the server-side checksum; if the checksums differ, the client updates the corresponding file. In addition, the client deletes any files that exist only locally but not on the server side, and it fetches any new files that have been added to the server since the last time the client was run.

If you edit a client-side file and change its contents, the client does *not* realize that this has happened and patch the file to be in sync with the version on the server again. This is because the client normally does not recompute the checksum for a file to see whether the stored checksum in `IcePatch2.sum` still agrees with the actual checksum for the current file contents.

If you have locally modified some files and want to make sure that those modified files are updated to reflect the contents of the same files on the server side, you must run a thorough patch with the `-t` option. Then the client first traverses the local data directory and recomputes the checksum for each file, and then compares these checksums against the server-side ones. This means that, if you edit a file locally so it differs from the server-side version, `-t` forces that file to be updated.

Preventing Deletion of Local Files

By default, the client deletes any files that exist in the local data directory but that are unknown to the server. If you do not want this behavior, you can set the `IcePatch2.Remove` property to 0 (the default value is 1). This prevents deletion of files and directories that exist only on the client side.

Creating an Incremental Patch

Suppose you have a number of deployed clients that have been patched previously, and you want to distribute a new version of the application to these clients. To update the clients with the new version of the application, the clients can do a thorough patch. However, this is expensive if the pre-existing file set on the client side is large, because a thorough patch recompresses all files to compute the checksums.

As an alternative, you can place all the files for the distribution into a directory and run `icepatch2calc -Z` on that directory. With the `-Z` option, `icepatch2calc` creates a checksum file with the correct checksum, but with a file size of 0 for each file, that is, the `-Z` option omits compressing the files. Once you have created the new `IcePatch2.sum` file in this way, you can distribute it to clients which then can use it to patch their distribution without having to do a thorough patch. For large file sets, this can result in considerable time savings.

Setting Transfer Size

You can set the `IcePatch2.ChunkSize` property to control the number of bytes that the client fetches per request. The default value is 100 kilobytes.

44.5.1 `icepatch2client` Options

The client supports the following options:

- **-h, --help**
Displays a help message.
- **-v, --version**
Displays a version number.
- **-t, --thorough**
Do a thorough patch, recomputing all checksums.

44.6 Object Identities

An IcePatch2 service hosts one well-known object, which implements the `IcePatch2::FileServer` interface and has the default identity `IcePatch2/server`. If an application requires the use of multiple IcePatch2 services, it is a good idea to assign unique identities to the well-known objects by configuring the servers with different values for the `IcePatch2.InstanceName` property, as shown in the following example:

```
$ icepatch2server --IcePatch2.InstanceName=PublicFiles ...
```

This property changes the category of the object's identity, which becomes `PublicFiles/server`. The client's configuration must also be changed to reflect the new identity:

```
$ icepatch2client --IcePatch2.Endpoints="tcp -h somehost.com \  
> -p 10000" --IcePatch2.InstanceName=PublicFiles .
```

44.7 Creating a Custom Client

You may wish to closely integrate an IcePatch2 client into your own applications, for example, to provide a graphical user interface, or to present detailed progress updates during patching.

The Ice for C++ distribution ships with a simple graphical IcePatch2 client, as shown in Figure 44.3.

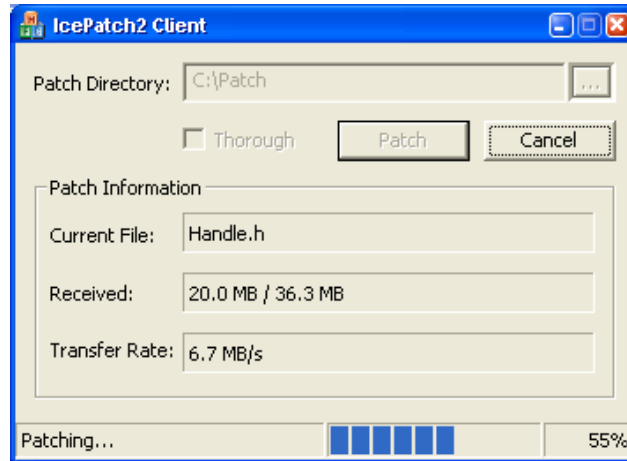

Figure 44.3. A graphical IcePatch2 client.

You can find the source code for this client in the `demo/IcePatch2/MFC` directory of the Ice distribution. You can use the code in this demo as the basis for your own graphical client. The Slice interfaces for IcePatch2 are documented in Appendix B.

44.8 Summary

IcePatch2 addresses a requirement common to both development and deployment scenarios: the safe, secure, and efficient replication of a directory tree. The IcePatch2 server is easy to configure and efficient. For simple uses, IcePatch2 provides a client that can be used to patch directory hierarchies from the command line. Using IcePatch2 demo as a starting point, you can create custom clients of your own if you require better integration of the client with your application.

Appendixes

Appendix A

Slice Keywords

The following identifiers are Slice keywords:

bool	enum	implements	module	string
byte	exception	int	nonmutating	struct
class	extends	interface	Object	throws
const	false	local	out	true
dictionary	float	LocalObject	sequence	void
double	idempotent	long	short	

Keywords must be capitalized as shown.

Appendix B

Slice Documentation

B.1 Ice

Overview

`module Ice`

The Ice core library. Among many other features, the Ice core library manages all the communication tasks using an efficient protocol (including protocol compression and support for both TCP and UDP), provides a thread pool for multi-threaded servers, and additional functionality that supports high scalability.

BoolSeq

`sequence<bool> BoolSeq;`

A sequence of bools.

ByteSeq

`sequence<byte> ByteSeq;`

A sequence of bytes.

Used By

BadMagicException::badMagic, ::IcePatch2::ByteSeqSeq,
::IcePatch2::FileInfo::checksum,
::IcePatch2::FileServer::getChecksum,
::IcePatch2::FileServer::getFileCompressed.

DoubleSeq

sequence<double> DoubleSeq;

A sequence of doubles.

EndpointSeq

local sequence<Endpoint> EndpointSeq;

FloatSeq

sequence<float> FloatSeq;

A sequence of floats.

IdentitySeq

sequence<Identity> IdentitySeq;

A sequence of identities.

Used By

::Glacier2::IdentitySet::add, ::Glacier2::IdentitySet::get,
::Glacier2::IdentitySet::remove.

IntSeq

sequence<int> IntSeq;

A sequence of ints.

LongSeq

sequence<long> LongSeq;

A sequence of longs.

ObjectProxySeq

sequence<Object*> ObjectProxySeq;

A sequence of object proxies.

Used By

Router::addProxies, ::IceGrid::Query::findAllObjectsByType.

ObjectSeq

sequence<Object> ObjectSeq;

A sequence of objects.

ShortSeq

sequence<short> ShortSeq;

A sequence of shorts.

StringSeq

sequence<string> StringSeq;

A sequence of strings.

Used By

::IceGrid::ApplicationUpdateDescriptor::removeVariables,
::Glacier2::SSLInfo::certs, ::Glacier2::StringSet::add,
::Glacier2::StringSet::get, ::Glacier2::StringSet::remove,
::IceGrid::ApplicationUpdateDescriptor::removeNodes,
::IceGrid::NodeUpdateDescriptor::removePropertySets, Properties::getCommandLineOptions, Properties::parseCommandLineOptions, Properties::parseIceCommandLineOptions, ::IceBox::Service::start,

```

::IceGrid::Admin::getAllAdapterIds, ::IceGrid::Admin::getAllApplica-
tionNames, ::IceGrid::Admin::getAllNodeNames,
::IceGrid::Admin::getAllServerIds, ::IceGrid::DistributionDe-
scriptor::directories, ::IceGrid::NodeUpdateDe-
scriptor::removeServers,
::IceGrid::NodeUpdateDescriptor::removeVariables,
::IceGrid::PatchException::reasons, ::IceGrid::PropertySetDe-
scriptor::references, ::IceGrid::ServerDescriptor::envs,
::IceGrid::ServerDescriptor::options, ::IceGrid::TemplateDe-
scriptor::parameters, ::IceGrid::ApplicationUpdateDe-
scriptor::removeServiceTemplates,
::IceGrid::ApplicationUpdateDescriptor::removeServerTemplates,
::IceGrid::ApplicationUpdateDescriptor::removeReplicaGroups,
::IceGrid::ApplicationUpdateDescriptor::removePropertySets.

```

Context

```
dictionary<string, string> Context;
```

A request context. Context is used to transmit metadata about a request from the server to the client, such as Quality-of-Service (QoS) parameters. Each operation on the client has a Context as its implicit final parameter.

Used By

```
Communicator::getDefaultContext, Communicator::setDefaultContext,
Current::ctx.
```

FacetMap

```
local dictionary<string, Object> FacetMap;
```

A mapping from facet name to servant.

Used By

```
ObjectAdapter::findAllFacets, ObjectAdapter::removeAllFacets.
```

ObjectDict

```
local dictionary<Identity, Object> ObjectDict;
```

A mapping between identities and Ice objects.

PropertyDict

local dictionary<string, string> PropertyDict;

A simple collection of properties, represented as a dictionary of key/value pairs. Both key and value are strings.

Used By

Properties::getPropertiesForPrefix.

See Also

Properties::getPropertiesForPrefix.

SliceChecksumDict

dictionary<string, string> SliceChecksumDict;

Used By

::IceBox::ServiceManager::getSliceChecksums,
::IceGrid::Admin::getSliceChecksums, ::IceStorm::TopicManager::getSliceChecksums.

B.2 Ice::AdapterAlreadyActiveException

Overview

exception AdapterAlreadyActiveException

This exception is raised if a server tries to set endpoints for an adapter that is already active.

Used By

LocatorRegistry::setAdapterDirectProxy, LocatorRegistry::setReplicatedAdapterDirectProxy.

B.3 Ice::AdapterNotFoundException

Overview

exception AdapterNotFoundException

This exception is raised if an adapter cannot be found.

Used By

Locator::findAdapterById, LocatorRegistry::setAdapterDirectProxy, LocatorRegistry::setReplicatedAdapterDirectProxy.

B.4 Ice::AlreadyRegisteredException

Overview

local exception AlreadyRegisteredException

This exception is raised if an attempt is made to register a servant, servant locator, facet, object factory, plug-in, object adapter, object, or user exception factory more than once for the same ID.

kindOfObject

string kindOfObject;

The kind of object that is registered already: "servant", "servant locator", "facet", "object factory", "plug-in", "object adapter", "object", or "user exception factory".

id

string id;

The id (or name) of the object that is registered already.

B.5 `Ice::BadMagicException`

Overview

Local exception `BadMagicException` extends `ProtocolException`

This exception is a specialization of `ProtocolException`, indicating that a message did not start with the expected magic number ('I', 'c', 'e', 'P').

`badMagic`

`ByteSeq badMagic;`

A sequence containing the first four bytes of the incorrect message.

B.6 `Ice::CloneNotImplementedException`

Overview

Local exception `CloneNotImplementedException`

This exception is raised if `ice_clone` is called on a class that is derived from an abstract `Slice` class (that is, a class containing operations), and the derived class does not provide an implementation of the `ice_clone` operation (C++ only).

B.7 `Ice::CloseConnectionException`

Overview

Local exception `CloseConnectionException` extends `ProtocolException`

This exception is a specialization of `ProtocolException`, indicating that the connection has been gracefully shut down by the server. The operation call that

caused this exception has not been executed by the server. In most cases you will not get this exception, because the client will automatically retry the operation call in case the server shut down the connection. However, if upon retry the server shuts down the connection again, and the retry limit has been reached, then this exception is propagated to the application code.

B.8 `Ice::CloseTimeoutException`

Overview

local exception `CloseTimeoutException` extends `TimeoutException`

This exception is a specialization of `TimeoutException` for connection closure timeout conditions.

B.9 `Ice::CollocationOptimizationException`

Overview

local exception `CollocationOptimizationException`

This exception is raised if a feature is requested that is not supported with collocation optimization.

B.10 `Ice::Communicator`

Overview

local interface `Communicator`

The central object in `Ice`. One or more communicators can be instantiated for an `Ice` application. `Communicator` instantiation is language specific, and not specified in `Slice` code.

Used By

`::Freeze::Connection::getCommunicator`, `ObjectAdapter::getCommunicator`, `::IceBox::Service::start`.

See Also

`Logger`, `Stats`, `ObjectAdapter`, `Properties`, `ObjectFactory`.

destroy

```
void destroy();
```

Destroy the communicator. This operation calls `shutdown` implicitly. Calling `destroy` cleans up memory, and shuts down this communicator's client functionality. Subsequent calls to `destroy` are ignored.

See Also

`shutdown`.

shutdown

```
void shutdown();
```

Shuts down this communicator's server functionality, including the deactivation of all object adapters. (Attempts to use a deactivated object adapter raise `ObjectAdapterDeactivatedException`.) Subsequent calls to `shutdown` are ignored. After `shutdown` returns, no new requests are processed. However, requests that have been started before `shutdown` was called might still be active. You can use `waitForShutdown` to wait for the completion of all requests.

See Also

`destroy`, `waitForShutdown`, `ObjectAdapter::deactivate`.

waitForShutdown

```
void waitForShutdown();
```

Wait until this communicator's server functionality has shut down completely. Calling `shutdown` initiates `shutdown`, and `waitForShutdown` only returns when all outstanding requests have completed. A typical use of this operation is to call it

from the main thread, which then waits until some other thread calls shutdown. After shutdown is complete, the main thread returns and can do some cleanup work before it finally calls `destroy` to also shut down the client functionality, and then exits the application.

See Also

`shutdown`, `destroy`, `ObjectAdapter::waitForDeactivate`.

stringToProxy

```
Object* stringToProxy(string str);
```

Convert a string into a proxy. For example, `MyCategory/MyObject:tcp -h some_host -p 10000` creates a proxy that refers to the Ice object having an identity with a name "MyObject" and a category "MyCategory", with the server running on host "some_host", port 10000. If the string does not parse correctly, the operation throws `ProxyParseException`.

Parameters

`str`

The string to convert into a proxy.

Return Value

The proxy.

See Also

`proxyToString`.

proxyToString

```
string proxyToString(Object* obj);
```

Convert a proxy into a string.

Parameters

`obj`

The proxy to convert into a string.

Return Value

The "stringified" proxy.

See Also

`stringToProxy`.

stringToIdentity

```
Identity stringToIdentity(string str);
```

Convert a string into an identity.

Parameters

`str`

The string to convert into an identity.

Return Value

The identity.

See Also

`identityToString`.

identityToString

```
string identityToString(Identity ident);
```

Convert an identity into a string.

Parameters

`ident`

The identity to convert into a string.

Return Value

The "stringified" identity.

See Also

`stringToIdentity`.

createObjectAdapter

```
ObjectAdapter createObjectAdapter(string name);
```

Create a new object adapter. The endpoints for the object adapter are taken from the property *name*.Endpoints.

Parameters

name

The object adapter name.

Return Value

The new object adapter.

See Also

`createObjectAdapterWithEndpoints`, `ObjectAdapter`, `Properties`.

createObjectAdapterWithEndpoints

```
ObjectAdapter createObjectAdapterWithEndpoints(string name, string endpoints);
```

Create a new object adapter with endpoints. This operation sets the property *name*.Endpoints, and then calls `createObjectAdapter`. It is provided as a convenience function.

It is legal to create an object adapter without any endpoints. Such an object adapter cannot be accessed remotely and, therefore, is accessible only for collocated invocations within a single address space.

Parameters

name

The object adapter name.

endpoints

The endpoints for the object adapter.

Return Value

The new object adapter.

See Also

`createObjectAdapter`, `ObjectAdapter`, `Properties`.

createObjectAdapterWithRouter

```
ObjectAdapter createObjectAdapterWithRouter(string name, Router* rtr);
```

Create a new object adapter with a router. This operation creates a routed object adapter.

Parameters

`name`

The object adapter name.

`router`

The router.

Return Value

The new object adapter.

See Also

`createObjectAdapter`, `ObjectAdapter`, `Properties`.

addObjectFactory

```
void addObjectFactory(ObjectFactory factory, string id);
```

Add a servant factory to this communicator. Installing a factory with an id for which a factory is already registered throws `AlreadyRegisteredException`.

When unmarshaling an Ice object, the Ice run-time reads the most-derived type id off the wire and attempts to create an instance of the type using a factory. If no instance is created, either because no factory was found, or because all factories returned nil, the object is sliced to the next most-derived type and the process repeats. If no factory is found that can create an instance, the Ice run-time throws `NoObjectFactoryException`.

The following order is used to locate a factory for a type:

1. The Ice run-time looks for a factory registered specifically for the type.
2. If no instance has been created, the Ice run-time looks for the default factory, which is registered with an empty type id.
3. If no instance has been created by any of the preceding steps, the Ice run-time looks for a factory that may have been statically generated by the language mapping for non-abstract classes.

Parameters

factory

The factory to add.

id

The type id for which the factory can create instances, or an empty string for the default factory.

See Also

`findObjectFactory`, `ObjectFactory`.

`findObjectFactory`

```
ObjectFactory findObjectFactory(string id);
```

Find a servant factory registered with this communicator.

Parameters

id

The type id for which the factory can create instances, or an empty string for the default factory.

Return Value

The servant factory, or null if no servant factory was found for the given id.

See Also

`addObjectFactory`, `ObjectFactory`.

getDefaultContext

```
Context getDefaultContext();
```

Get the currently-set default context.

Return Value

The currently established default context. If no default context is currently set, `getDefaultContext` returns an empty context.

See Also

`setDefaultContext`.

setDefaultContext

```
void setDefaultContext(Context ctx);
```

Set a default context on this communicator. All newly created proxies will use this default context. This operation has no effect on existing proxies.

You can also set a context for an individual proxy by calling the operation `ice_context` on the proxy.

Parameters

`ctx`

The default context to be set.

See Also

`getDefaultContext`.

getProperties

```
Properties getProperties();
```

Get the properties for this communicator.

Return Value

This communicator's properties.

See Also

Properties.

getLogger

```
Logger getLogger();
```

Get the logger for this communicator.

Return Value

This communicator's logger.

See Also

Logger.

getStats

```
Stats getStats();
```

Get the statistics callback object for this communicator.

Return Value

This communicator's statistics callback object.

See Also

Stats.

getDefaultRouter

```
Router* getDefaultRouter();
```

Get the default router this communicator.

Return Value

The default router for this communicator.

See Also

setDefaultRouter, Router.

setDefaultRouter

```
void setDefaultRouter(Router* rtr);
```

Set a default router for this communicator. All newly created proxies will use this default router. To disable the default router, null can be used. Note that this operation has no effect on existing proxies.

You can also set a router for an individual proxy by calling the operation `ice_router` on the proxy.

Parameters

`rtr`

The default router to use for this communicator.

See Also

`getDefaultRouter`, `createObjectAdapterWithRouter`, `Router`.

getDefaultLocator

```
Locator* getDefaultLocator();
```

Get the default locator this communicator.

Return Value

The default locator for this communicator.

See Also

`setDefaultLocator`, `Locator`.

setDefaultLocator

```
void setDefaultLocator(Locator* loc);
```

Set a default Ice locator for this communicator. All newly created proxy and object adapters will use this default locator. To disable the default locator, null can be used. Note that this operation has no effect on existing proxies or object adapters.

You can also set a locator for an individual proxy by calling the operation `ice_locator` on the proxy, or for an object adapter by calling the operation `setLocator` on the object adapter.

Parameters

`loc`

The default locator to use for this communicator.

See Also

`getDefaultLocator`, `Locator`, `ObjectAdapter::setLocator`.

getPluginManager

```
PluginManager getPluginManager();
```

Get the plug-in manager for this communicator.

Return Value

This communicator's plug-in manager.

See Also

`PluginManager`.

flushBatchRequests

```
void flushBatchRequests();
```

Flush any pending batch requests for this communicator. This causes all batch requests that were sent via proxies obtained via this communicator to be sent to the server.

B.11 `Ice::CommunicatorDestroyedException`

Overview

Local exception `CommunicatorDestroyedException`

This exception is raised if the `Communicator` has been destroyed.

See Also

`Communicator::destroy`.

B.12 `Ice::CompressionException`

Overview

Local exception `CompressionException` extends `ProtocolException`

This exception is a specialization of `ProtocolException` that is raised if there is a problem with compressing or uncompressing data.

B.13 `Ice::ConnectFailedException`

Overview

Local exception `ConnectFailedException` extends `SocketException`

This exception is a specialization of `SocketException` for connection failures.

Derived Exceptions

`ConnectionRefusedException`.

B.14 `Ice::ConnectTimeoutException`

Overview

Local exception `ConnectTimeoutException` extends `TimeoutException`

This exception is a specialization of `TimeoutException` for connection establishment timeout conditions.

B.15 Ice::Connection

Overview

Local interface Connection

The user-level interface to a connection.

Used By

Current::con.

close

```
void close(bool force);
```

Close a connection, either gracefully or forcefully. If a connection is closed forcefully, it closes immediately, without sending the relevant close connection protocol messages to the peer and waiting for the peer to acknowledge these protocol messages.

Parameters

force

If true, close forcefully. Otherwise the connection is closed gracefully.

createProxy

```
Object* createProxy(Identity id);
```

Create a special proxy that always uses this connection. This can be used for call-backs from a server to a client if the server cannot directly establish a connection to the client, for example because of firewalls. In this case, the server would create a proxy using an already established connection from the client.

Parameters

id

The identity for which a proxy is to be created.

Return Value

A proxy that matches the given identity and uses this connection.

See Also

setAdapter.

setAdapter

```
void setAdapter(ObjectAdapter adapter);
```

Explicitly set an object adapter that dispatches requests that are received over this connection. A client can invoke an operation on a server using a proxy, and then set an object adapter for the outgoing connection that is used by the proxy in order to receive callbacks. This is useful if the server cannot establish a connection back to the client, for example because of firewalls.

Parameters

adapter

The object adapter that should be used by this connection to dispatch requests. The object adapter must be activated. When the object adapter is deactivated, it is automatically removed from the connection.

See Also

createProxy, setAdapter.

getAdapter

```
ObjectAdapter getAdapter();
```

Get the object adapter that dispatches requests for this connection.

Return Value

The object adapter that dispatches requests for the connection, or null if no adapter is set.

See Also

setAdapter.

flushBatchRequests

```
void flushBatchRequests();
```

Flush any pending batch requests for this connection. This causes all batch requests that were sent via proxies that use this connection to be sent to the server.

type

```
string type();
```

Return the connection type. This corresponds to the endpoint type, i.e., "tcp", "udp", etc.

Return Value

The type of the connection.

timeout

```
int timeout();
```

Get the timeout for the connection.

Return Value

The connection's timeout.

toString

```
string toString();
```

Return a description of the connection as human readable text, suitable for logging or error messages.

Return Value

The description of the connection as human readable text.

B.16 Ice::ConnectionLostException

Overview

Local exception `ConnectionLostException` extends `SocketException`

This exception is a specialization of `SocketException`, indicating a lost connection.

B.17 Ice::ConnectionNotValidatedException

Overview

Local exception `ConnectionNotValidatedException` extends `ProtocolException`

This exception is a specialization of `ProtocolException`, that is raised if a message is received over a connection that is not yet validated.

B.18 Ice::ConnectionRefusedException

Overview

Local exception `ConnectionRefusedException` extends `ConnectFailedException`

This exception is a specialization of `ConnectFailedException` for connection failures, where the server host actively refuses a connection.

B.19 Ice::ConnectionTimeoutException

Overview

Local exception `ConnectionTimeoutException` extends `TimeoutException`

This exception is a specialization of `TimeoutException`, and indicates that a connection has been shut down because it has been idle for some time.

B.20 `Ice::Current`

Overview

local struct `Current`

Information about the current method invocation for servers. Each operation on the server has a `Current` as its implicit final parameter. `Current` is mostly used for Ice services. Most applications ignore this parameter.

Used By

`ServantLocator::finished`, `ServantLocator::locate`.

`adapter`

`ObjectAdapter adapter;`

The object adapter.

`con`

`Connection con;`

Information about the connection over which the current method invocation was received. If the invocation is direct due to collocation optimization, this value is set to null.

`id`

`Identity id;`

The Ice object identity.

facet

string facet;

The facet.

operation

string operation;

The operation name.

mode

OperationMode mode;

The mode of the operation.

ctx

Context ctx;

The request context, as received from the client.

requestId

int requestId;

The request id unless oneway (0) or collocated (-1).

B.21 Ice::DNSException

Overview

local exception DNSException

This exception indicates a DNS problem. For details on the cause, error should be inspected.

error

```
int error;
```

The error number describing the DNS problem. For C++ and Unix, this is equivalent to `h_errno`. For C++ and Windows, this is the value returned by `WSAGetLastError()`.

host

```
string host;
```

The host name that could not be resolved.

B.22 Ice::DatagramLimitException

Overview

Local exception `DatagramLimitException` extends `ProtocolException`

This exception is a specialization of `ProtocolException` that is raised if a datagram exceeds the configured send or receive buffer size, or exceeds the maximum payload size of a UDP packet (65507 bytes).

B.23 Ice::EncapsulationException

Overview

Local exception `EncapsulationException` extends `MarshalException`

This exception is a specialization of `MarshalException`, indicating a malformed data encapsulation.

B.24 Ice::Endpoint

Overview

local interface Endpoint

The user-level interface to an endpoint.

Used By

EndpointSeq.

toString

```
string toString();
```

Return a string representation of the endpoint.

Return Value

The string representation of the endpoint.

B.25 Ice::EndpointParseException

Overview

local exception EndpointParseException

This exception is raised if there was an error while parsing an endpoint.

str

```
string str;
```

The string that could not be parsed.

B.26 `Ice::EndpointSelectionType`

Overview

enum `EndpointSelectionType`

Determines the order in which the Ice run time uses the endpoints in a proxy when establishing a connection.

Random

Random

Random causes the endpoints to be arranged in a random order.

Ordered

Ordered

Ordered forces the Ice run time to use the endpoints in the order they appeared in the proxy.

B.27 `Ice::FacetNotExistException`

Overview

Local exception `FacetNotExistException` extends `RequestFailedException`

This exception is raised if no facet with the given name exists, but at least one facet with the given identity exists.

B.28 `Ice::FeatureNotSupportedException`

Overview

Local exception `FeatureNotSupportedException`

This exception is raised if an unsupported feature is used. The unsupported feature string contains the name of the unsupported feature

`unsupportedFeature`

string `unsupportedFeature`;

The name of the unsupported feature.

B.29 `Ice::FileException`

Overview

Local exception `FileException` extends `SyscallException`

This exception is a specialization of `SyscallException` for file errors.

`path`

string `path`;

The path of the file responsible for the error.

B.30 `Ice::ForcedCloseConnectionException`

Overview

Local exception `ForcedCloseConnectionException` extends `ProtocolException`

This exception is raised by an operation call if the application forcefully closes the connection used by this call with `Connection::close`.

See Also

`Connection::close`.

B.31 Ice::Identity

Overview

```
struct Identity
```

The identity of an Ice object. An empty name denotes a null object.

Used By

```
::Freeze::Evictor::add, ::Freeze::Evictor::addFacet,
::Freeze::Evictor::createObject, ::Freeze::Evictor::destroyObject,
::Freeze::Evictor::hasFacet, ::Freeze::Evictor::hasObject,
::Freeze::Evictor::keep, ::Freeze::Evictor::keepFacet,
::Freeze::Evictor::release, ::Freeze::Evictor::releaseFacet,
::Freeze::Evictor::remove, ::Freeze::Evictor::removeFacet,
::Freeze::EvictorIterator::next, ::Freeze::ServantInitial-
izer::initialize, Communicator::identityToString,
Communicator::stringToIdentity, Connection::createProxy, Current::id,
IdentitySeq, IllegalIdentityException::id, Locator::findObjectById,
ObjectAdapter::add, ObjectAdapter::addFacet, ObjectAdapter::create-
DirectProxy, ObjectAdapter::createIndirectProxy, Object-
Adapter::createProxy, ObjectAdapter::createReverseProxy,
ObjectAdapter::find, ObjectAdapter::findAllFacets, Object-
Adapter::findFacet, ObjectAdapter::remove, ObjectAdapter::removeAll-
Facets, ObjectAdapter::removeFacet, ObjectDict,
RequestFailedException::id, ::IceGrid::Admin::getObjectInfo,
::IceGrid::Admin::removeObject, ::IceGrid::AdminSession::setObserv-
ersByIdentity, ::IceGrid::ObjectDescriptor::id, ::IceGrid::ObjectEx-
istsException::id, ::IceGrid::ObjectNotRegisteredException::id,
::IceGrid::Query::findObjectById, ::IceGrid::RegistryOb-
```

`server::objectRemoved, ::IceGrid::Session::allocateObjectById,
::IceGrid::Session::releaseObject.`

name

`string name;`

The name of the Ice object.

category

`string category;`

The Ice object category.

See Also

`ServantLocator, ObjectAdapter::addServantLocator.`

B.32 `Ice::IdentityParseException`

Overview

local exception `IdentityParseException`

This exception is raised if there was an error while parsing a stringified identity.

str

`string str;`

The string that could not be parsed.

B.33 `Ice::IllegalIdentityException`

Overview

local exception `IllegalIdentityException`

This exception is raised if an illegal identity is encountered.

`id`

Identity `id`;

The illegal identity.

B.34 `Ice::IllegalIndirectionException`

Overview

local exception `IllegalIndirectionException` extends `MarshalException`

This exception is a specialization of `MarshalException`, indicating an illegal indirection during unmarshaling.

B.35 `Ice::IllegalMessageSizeException`

Overview

local exception `IllegalMessageSizeException` extends `ProtocolException`

This exception is a specialization of `ProtocolException`, indicating that the message size is illegal, i.e., it is less than the minimum required size.

B.36 `Ice::InitializationException`

Overview

local exception `InitializationException`

This exception is raised when a failure occurs during initialization.

reason

```
string reason;
```

The reason for the failure.

B.37 Ice::InvalidReplicaGroupIdException

Overview

exception InvalidReplicaGroupIdException

This exception is raised if the replica group provided by the server is invalid.

Used By

LocatorRegistry::setReplicatedAdapterDirectProxy.

B.38 Ice::Locator

Overview

interface Locator

The Ice locator interface. This interface is used by clients to lookup adapters and objects. It is also used by servers to get the locator registry proxy.

The Locator interface is intended to be used by Ice internals and by locator implementations. Regular user code should not attempt to use any functionality of this interface directly.

findObjectById

```
[ "amd" ] Object* findObjectById(Identity id) throws  
ObjectNotFoundException;
```

Find an object by identity and return its proxy.

Parameters

id

The identity.

Return Value

The proxy, or null if the object is not active.

Exceptions

`ObjectNotFoundException`

Raised if the object cannot be found.

findAdapterById

```
[ "amd" ] Object* findAdapterById(string id) throws  
AdapterNotFoundException;
```

Find an adapter by id and return its proxy (a dummy direct proxy created by the adapter).

Parameters

id

The adapter id.

Return Value

The adapter proxy, or null if the adapter is not active.

Exceptions

`AdapterNotFoundException`

Raised if the adapter cannot be found.

getRegistry

```
LocatorRegistry* getRegistry();
```

Get the locator registry.

Return Value

The locator registry.

B.39 Ice::LocatorRegistry

Overview

interface LocatorRegistry

The Ice locator registry interface. This interface is used by servers to register adapter endpoints with the locator.

The LocatorRegistry interface is intended to be used by Ice internals and by locator implementations. Regular user code should not attempt to use any functionality of this interface directly.

setAdapterDirectProxy

```
[ "amd" ] void setAdapterDirectProxy(string id, Object* proxy)
throws AdapterNotFoundException, AdapterAlreadyActiveException;
```

Set the adapter endpoints with the locator registry.

Parameters

adapterId

The adapter id.

proxy

The adapter proxy (a dummy direct proxy created by the adapter). The direct proxy contains the adapter endpoints.

Exceptions

AdapterNotFoundException

Raised if the adapter cannot be found, or if the locator only allows registered adapters to set their active proxy and the adapter is not registered with the locator.

AdapterAlreadyActive

Raised if an adapter with the same id is already active.

setReplicatedAdapterDirectProxy

```
[ "amd" ] void setReplicatedAdapterDirectProxy(string adapterId,
string replicaGroupId, Object* proxy) throws
AdapterNotFoundException, AdapterAlreadyActiveException,
InvalidReplicaGroupIdException;
```

Set the adapter endpoints with the locator registry.

Parameters

adapterId

The adapter id.

replicaGroupId

The replica group id.

proxy

The adapter proxy (a dummy direct proxy created by the adapter). The direct proxy contains the adapter endpoints.

Exceptions

AdapterNotFoundException

Raised if the adapter cannot be found, or if the locator only allows registered adapters to set their active proxy and the adapter is not registered with the locator.

AdapterAlreadyActive

Raised if an adapter with the same id is already active.

InvalidReplicaGroupIdException

Raised if the given replica group doesn't match the one registered with the locator registry for this object adapter.

setServerProcessProxy

```
[ "amd" ] void setServerProcessProxy(string id, Process* proxy)
throws ServerNotFoundException;
```

Set the process proxy for a server.

Parameters

id

The server id.

proxy

The process proxy.

Exceptions

ServerNotFoundException

Raised if the server cannot be found.

B.40 Ice::Logger

Overview

local interface `Logger`

The Ice message logger. Applications can provide their own logger by implementing this interface and installing it in a communicator.

Used By

`Communicator::getLogger`.

print

```
void print(string message);
```

Print a message. The message is printed literally, without any decorations such as executable name or time stamp.

trace

```
void trace(string category, string message);
```

Log a trace message.

Parameters

category

The trace category.

message

The trace message to log.

warning

```
void warning(string message);
```

Log a warning message.

Parameters

message

The warning message to log.

See Also

error.

error

```
void error(string message);
```

Log an error message.

Parameters

message

The error message to log.

See Also

warning.

B.41 Ice::MarshalException

Overview

Local exception `MarshalException` extends `ProtocolException`

This exception is a specialization of `ProtocolException` that is raised upon an error during marshaling or unmarshaling data.

Derived Exceptions

`EncapsulationException`, `IllegalIndirectionException`, `MemoryLimitException`, `NegativeSizeException`, `NoObjectFactoryException`, `ProxyUnmarshalException`, `StringConversionException`, `UnmarshalOutOfBoundsException`.

B.42 Ice::MemoryLimitException

Overview

Local exception `MemoryLimitException` extends `MarshalException`

This exception is a specialization of `MarshalException` that is raised if the system-specific memory limit is exceeded during marshaling or unmarshaling.

B.43 Ice::NegativeSizeException

Overview

Local exception `NegativeSizeException` extends `MarshalException`

This exception is a specialization of `MarshalException` that is raised if a negative size (e.g., a negative sequence size) is received.

B.44 Ice::NoEndpointException

Overview

local exception NoEndpointException

This exception is raised if no suitable endpoint is available.

proxy

string proxy;

The stringified proxy for which no suitable endpoint is available.

B.45 Ice::NoObjectFactoryException

Overview

local exception NoObjectFactoryException extends MarshalException

This exception is a specialization of MarshalException that is raised if no suitable object factory was found during object unmarshaling.

See Also

ObjectFactory, Communicator::addObjectFactory, Communicator::findObjectFactory.

type

string type;

The absolute Slice type id of the object for which we could not find a factory.

B.46 Ice::NotRegisteredException

Overview

Local exception NotRegisteredException

This exception is raised if an attempt is made to remove a servant, facet, object factory, plug-in, object adapter, object, or user exception factory that is not currently registered.

kindOfObject

string kindOfObject;

The kind of object that could not be removed: "servant", "facet", "object factory", "plug-in", "object adapter", "object", or "user exception factory".

id

string id;

The id (or name) of the object that could not be removed.

B.47 Ice::ObjectAdapter

Overview

Local interface ObjectAdapter

The object adapter, which is responsible for receiving requests from endpoints, and for mapping between servants, identities, and proxies.

Used By

::Freeze::ServantInitializer::initialize, Communicator::createObjectAdapter, Connection::getAdapter, Connection::setAdapter, Current::adapter, Communicator::createObjectAdapterWithRouter, Communicator::createObjectAdapterWithEndpoints.

See Also

Communicator, ServantLocator.

getName

```
string getName();
```

Get the name of this object adapter.

Return Value

This object adapter's name.

getCommunicator

```
Communicator getCommunicator();
```

Get the communicator this object adapter belongs to.

Return Value

This object adapter's communicator.

See Also

Communicator.

activate

```
void activate();
```

Activate all endpoints that belong to this object adapter. After activation, the object adapter can dispatch requests received through its endpoints.

See Also

hold, deactivate.

hold

```
void hold();
```

Temporarily hold receiving and dispatching requests. The object adapter can be reactivated with the `activate` operation.

Holding is not immediate, i.e., after `hold` returns, the object adapter might still be active for some time. You can use `waitForHold` to wait until holding is complete.

See Also

`activate`, `deactivate`, `waitForHold`.

`waitForHold`

```
void waitForHold();
```

Wait until the object adapter holds requests. Calling `hold` initiates holding of requests, and `waitForHold` only returns when holding of requests has been completed.

See Also

`hold`, `waitForDeactivate`, `Communicator::waitForShutdown`.

`deactivate`

```
void deactivate();
```

Deactivate all endpoints that belong to this object adapter. After deactivation, the object adapter stops receiving requests through its endpoints. Object adapters that have been deactivated must not be reactivated again, and cannot be used otherwise. Attempts to use a deactivated object adapter raise `ObjectAdapterDeactivatedException`; however, attempts to deactivate an already deactivated object adapter are ignored and do nothing.

After `deactivate` returns, no new requests are processed by the object adapter. However, requests that have been started before `deactivate` was called might still be active. You can use `waitForDeactivate` to wait for the completion of all requests for this object adapter.

See Also

`activate`, `hold`, `waitForDeactivate`, `Communicator::shutdown`.

waitForDeactivate

```
void waitForDeactivate();
```

Wait until the object adapter has deactivated. Calling `deactivate` initiates object adapter deactivation, and `waitForDeactivate` only returns when deactivation has been completed. Once `waitForDeactivate` has returned it is possible to recreate an object adapter with the same name.

See Also

`deactivate`, `waitForHold`, `Communicator::waitForShutdown`.

add

```
Object* add(Object servant, Identity id);
```

Add a servant to this object adapter's Active Servant Map. Note that one servant can implement several Ice objects by registering the servant with multiple identities. Adding a servant with an identity that is in the map already throws `AlreadyRegisteredException`.

Parameters

`servant`

The servant to add.

`id`

The identity of the Ice object that is implemented by the servant.

Return Value

A proxy that matches the given identity and this object adapter.

See Also

`Identity`, `addFacet`, `addWithUUID`, `remove`, `find`.

addFacet

```
Object* addFacet(Object servant, Identity id, string facet);
```

Like `add`, but with a facet. Calling `add(servant, * id)` is equivalent to calling `addFacet` with an empty facet.

Parameters

servant

The servant to add.

id

The identity of the Ice object that is implemented by the servant.

facet

The facet. An empty facet means the default facet.

Return Value

A proxy that matches the given identity, facet, and this object adapter.

See Also

Identity, add, addFacetWithUUID, removeFacet, findFacet.

addWithUUID

```
Object* addWithUUID(Object servant);
```

Add a servant to this object adapter's Active Servant Map, using an automatically generated UUID as its identity. Note that the generated UUID identity can be accessed using the proxy's `ice_getIdentity` operation.

Parameters

servant

The servant to add.

Return Value

A proxy that matches the generated UUID identity and this object adapter.

See Also

Identity, add, addFacetWithUUID, remove, find.

addFacetWithUUID

```
Object* addFacetWithUUID(Object servant, string facet);
```

Like `addWithUUID`, but with a facet. Calling `addWithUUID(servant)` is equivalent to calling `addFacetWithUUID` with an empty facet.

Parameters

`servant`

The servant to add.

`facet`

The facet. An empty facet means the default facet.

Return Value

A proxy that matches the generated UUID identity, facet, and this object adapter.

See Also

`Identity`, `addFacet`, `addWithUUID`, `removeFacet`, `findFacet`.

`remove`

```
Object remove(Identity id);
```

Remove a servant (that is, the default facet) from the object adapter's Active Servant Map.

Parameters

`id`

The identity of the Ice object that is implemented by the servant. If the servant implements multiple Ice objects, `remove` has to be called for all those Ice objects. Removing an identity that is not in the map throws `NotRegisteredException`.

Return Value

The removed servant.

See Also

`Identity`, `add`, `addWithUUID`.

removeFacet

```
Object removeFacet(Identity id, string facet);
```

Like `remove`, but with a facet. Calling `remove(id)` is equivalent to calling `removeFacet` with an empty facet.

Parameters

`id`

The identity of the Ice object that is implemented by the servant.

`facet`

The facet. An empty facet means the default facet.

Return Value

The removed servant.

See Also

`Identity`, `addFacet`, `addFacetWithUUID`.

removeAllFacets

```
FacetMap removeAllFacets(Identity id);
```

Remove all facets with the given identity from the Active Servant Map (that is, completely remove the Ice object, including its default facet). Removing an identity that is not in the map throws `NotRegisteredException`.

Parameters

`id`

The identity of the Ice object to be removed.

Return Value

A collection containing all the facet names and servants of the removed Ice object.

See Also

`remove`, `removeFacet`.

find

```
Object find(Identity id);
```

Look up a servant in this object adapter's Active Servant Map by the identity of the Ice object it implements.

This operation only tries to lookup a servant in the Active Servant Map. It does not attempt to find a servant by using any installed `ServantLocator`.

Parameters

`id`

The identity of the Ice object for which the servant should be returned.

Return Value

The servant that implements the Ice object with the given identity, or null if no such servant has been found.

See Also

`Identity`, `findFacet`, `findByProxy`.

findFacet

```
Object findFacet(Identity id, string facet);
```

Like `find`, but with a facet. Calling `find(id)` is equivalent to calling `findFacet` with an empty facet.

Parameters

`id`

The identity of the Ice object for which the servant should be returned.

`facet`

The facet. An empty facet means the default facet.

Return Value

The servant that implements the Ice object with the given identity and facet, or null if no such servant has been found.

See Also

Identity, find, findByProxy.

findAllFacets

```
FacetMap findAllFacets(Identity id);
```

Find all facets with the given identity in the Active Servant Map.

Parameters

id

The identity of the Ice object for which the facets should be returned.

Return Value

A collection containing all the facet names and servants which have been found, or an empty map if there is no facet for the given identity.

See Also

find, findFacet.

findByProxy

```
Object findByProxy(Object* proxy);
```

Look up a servant in this object adapter's Active Servant Map, given a proxy.

This operation only tries to lookup a servant in the Active Servant Map. It does not attempt to find a servant via any installed ServantLocators.

Parameters

proxy

The proxy for which the servant should be returned.

Return Value

The servant that matches the proxy, or null if no such servant has been found.

See Also

find, findFacet.

addServantLocator

```
void addServantLocator(ServantLocator locator, string category);
```

Add a Servant Locator to this object adapter. Adding a servant locator for a category for which a servant locator is already registered throws `AlreadyRegisteredException`. To dispatch operation calls on servants, the object adapter tries to find a servant for a given Ice object identity and facet in the following order:

1. The object adapter tries to find a servant for the identity and facet in the Active Servant Map.
2. If no servant has been found in the Active Servant Map, the object adapter tries to find a locator for the category component of the identity. If a locator is found, the object adapter tries to find a servant using this locator.
3. If no servant has been found by any of the preceding steps, the object adapter tries to find a locator for an empty category, regardless of the category contained in the identity. If a locator is found, the object adapter tries to find a servant using this locator.
4. If no servant has been found with any of the preceding steps, the object adapter gives up and the caller receives `ObjectNotExistException` or `FacetNotExistException`.

Only one locator for the empty category can be installed.

Parameters

locator

The locator to add.

category

The category for which the Servant Locator can locate servants, or an empty string if the Servant Locator does not belong to any specific category.

See Also

Identity, findServantLocator, ServantLocator.

findServantLocator

```
ServantLocator findServantLocator(string category);
```

Find a Servant Locator installed with this object adapter.

Parameters

category

The category for which the Servant Locator can locate servants, or an empty string if the Servant Locator does not belong to any specific category.

Return Value

The Servant Locator, or null if no Servant Locator was found for the given category.

See Also

Identity, addServantLocator, ServantLocator.

createProxy

```
Object* createProxy(Identity id);
```

Create a proxy for the object with the given identity. If this object adapter is configured with an adapter id, the return value is an indirect proxy that refers to the adapter id. If a replica group id is also defined, the return value is an indirect proxy that refers to the replica group id. Otherwise, if no adapter id is defined, the return value is a direct proxy containing this object adapter's published endpoints.

Parameters

id

The object's identity.

Return Value

A proxy for the object with the given identity.

See Also

Identity.

createDirectProxy

```
Object* createDirectProxy(Identity id);
```

Create a direct proxy for the object with the given identity. The returned proxy contains this object adapter's published endpoints.

Parameters

`id`

The object's identity.

Return Value

A proxy for the object with the given identity.

See Also

`Identity`.

`createIndirectProxy`

```
Object* createIndirectProxy(Identity id);
```

Create an indirect proxy for the object with the given identity. If this object adapter is configured with an adapter id, the return value refers to the adapter id. Otherwise, the return value contains only the object identity.

Parameters

`id`

The object's identity.

Return Value

A proxy for the object with the given identity.

See Also

`Identity`.

`createReverseProxy`

```
Object* createReverseProxy(Identity id);
```

Create a "reverse proxy" for the object with the given identity. A reverse proxy uses the incoming connections that have been established from a client to this object adapter.

This operation is intended to be used by special services, such as Router implementations. Regular user code should not attempt to use this operation.

Parameters

id

The identity for which a proxy is to be created.

Return Value

A "reverse proxy" that matches the given identity and uses the incoming connections of this object adapter.

See Also

Identity.

setLocator

```
void setLocator(Locator* loc);
```

Set an Ice locator for this object adapter. By doing so, the object adapter will register itself with the locator registry when it is activated for the first time. Furthermore, the proxies created by this object adapter will contain the adapter name instead of its endpoints.

Parameters

loc

The locator used by this object adapter.

See Also

createDirectProxy, Locator, LocatorRegistry.

B.48 Ice::ObjectAdapterDeactivatedException

Overview

```
local exception ObjectAdapterDeactivatedException
```

This exception is raised if an attempt is made to use a deactivated ObjectAdapter.

See Also

`ObjectAdapter::deactivate`, `Communicator::shutdown`.

name

string name;

Name of the adapter.

B.49 `Ice::ObjectAdapterIdInUseException`

Overview

local exception `ObjectAdapterIdInUseException`

This exception is raised if an `ObjectAdapter` cannot be activated because the `Locator` detected another active `ObjectAdapter` with the same adapter id.

id

string id;

Adapter id.

B.50 `Ice::ObjectFactory`

Overview

local interface `ObjectFactory`

A factory for objects. Object factories are used in several places, for example, when receiving "objects by value" and when `::Freeze` restores a persistent object. Object factories must be implemented by the application writer, and registered with the communicator.

Used By

Communicator::addObjectFactory, Communicator::findObjectFactory.

See Also

::Freeze.

create

```
Object create(string type);
```

Create a new object for a given object type. The type is the absolute Slice type id, i.e., the id relative to the unnamed top-level Slice module. For example, the absolute Slice type id for interfaces of type Bar in the module Foo is ::Foo::Bar.

The leading "::" is required.

Parameters

type

The object type.

Return Value

The object created for the given type, or nil if the factory is unable to create the object.

destroy

```
void destroy();
```

Called when the factory is removed from the communicator, or if the communicator is destroyed.

See Also

Communicator::destroy.

B.51 `Ice::ObjectNotExistException`

Overview

Local exception `ObjectNotExistException` extends `RequestFailedException`

This exception is raised if an object does not exist on the server, that is, if no facets with the given identity exist.

B.52 `Ice::ObjectNotFoundException`

Overview

exception `ObjectNotFoundException`

This exception is raised if an object cannot be found.

Used By

`Locator::findObjectById`.

B.53 `Ice::OperationMode`

Overview

enum `OperationMode`

The `OperationMode` determines the skeleton signature (for C++), as well as the retry behavior of the Ice run time for an operation invocation in case of a (potentially) recoverable error.

Used By

`Current::mode`.

Normal

Normal

Ordinary operations have Normal mode. These operations modify object state; invoking such an operation twice in a row has different semantics than invoking it once. The Ice run time guarantees that it will not violate at-most-once semantics for Normal operations.

Nonmutating

Nonmutating

Operations that use the Slice `Nonmutating` keyword must not modify object state. For C++, nonmutating operations generate `const` member functions in the skeleton. In addition, the Ice run time will attempt to transparently recover from certain run-time errors by re-issuing a failed request and propagate the failure to the application only if the second attempt fails.

Idempotent

Idempotent

Operations that use the Slice `Idempotent` keyword can modify object state, but invoking an operation twice in a row must result in the same object state as invoking it once. For example, `x = 1` is an idempotent statement, whereas `x += 1` is not. For idempotent operations, the Ice run-time uses the same retry behavior as for nonmutating operations in case of a potentially recoverable error.

B.54 Ice::OperationNotExistException

Overview

Local exception `OperationNotExistException` extends `RequestFailedException`

This exception is raised if an operation for a given object does not exist on the server. Typically this is caused by either the client or the server using an outdated Slice specification.

B.55 Ice::Plugin

Overview

Local interface Plugin

A communicator plugin. A plugin generally adds a feature to a communicator, such as support for a protocol. The communicator loads its plugins in two stages: the first stage creates the plugins, and the second stage invokes `initialize` on each one.

Used By

`PluginManager::addPlugin`, `PluginManager::getPlugin`.

`initialize`

```
void initialize();
```

Perform any necessary initialization steps.

`destroy`

```
void destroy();
```

Called when the communicator is being destroyed.

B.56 Ice::PluginInitializationException

Overview

Local exception `PluginInitializationException`

This exception indicates that a failure occurred while initializing a plug-in.

`reason`

```
string reason;
```

The reason for the failure.

B.57 `Ice::PluginManager`

Overview

local interface `PluginManager`

Each communicator has a plugin manager to administer the set of plugins.

Used By

`Communicator::getPluginManager`.

`initializePlugins`

```
void initializePlugins();
```

Initialize the configured plugins. The communicator automatically initializes the plugins by default, but an application may need to interact directly with a plugin prior to initialization. In this case, the application must set `Ice.InitPlugins=0` and then invoke `initializePlugins` manually. The plugins are initialized in the order in which they are loaded. If a plugin raises an exception during initialization, the communicator invokes `destroy` on the plugins that have already been initialized.

Exceptions

`InitializationException`

 Raised if the plugins have already been initialized.

`getPlugin`

```
Plugin getPlugin(string name);
```

Obtain a plugin by name.

Parameters

name

The plugin's name.

Return Value

The plugin.

Exceptions

`NotRegisteredException`

Raised if no plugin is found with the given name.

addPlugin

```
void addPlugin(string name, Plugin pi);
```

Install a new plugin.

Parameters

name

The plugin's name.

pi

The plugin.

Exceptions

`AlreadyRegisteredException`

Raised if a plugin already exists with the given name.

destroy

```
void destroy();
```

Called when the communicator is being destroyed.

B.58 Ice::Process

Overview

interface Process

An administrative interface for process management. Managed servers must implement this interface.

A servant implementing this interface is a potential target for denial-of-service attacks, therefore proper security precautions should be taken. For example, the servant can use a UUID to make its identity harder to guess, and be registered in an object adapter with a secured endpoint.

shutdown

```
[ "ami" ] void shutdown();
```

Initiate a graceful shutdown.

See Also

Communicator::shutdown.

writeMessage

```
void writeMessage(string message, int fd);
```

Write a message on the process' stdout or stderr.

Parameters

message

The message.

fd

1 for stdout, 2 for stderr.

B.59 Ice::Properties

Overview

Local interface Properties

A property set used to configure Ice and Ice applications. Properties are key/value pairs, with both keys and values being strings. By convention, property keys should have the form *application-name[.category[.sub-category]].name*.

Used By

Communicator::getProperties, clone.

getProperty

```
string getProperty(string key);
```

Get a property by key. If the property does not exist, an empty string is returned.

Parameters

key

The property key.

Return Value

The property value.

See Also

setProperty.

getPropertyWithDefault

```
string getPropertyWithDefault(string key, string value);
```

Get a property by key. If the property does not exist, the given default value is returned.

Parameters

key

The property key.

value

The default value to use if the property does not exist.

Return Value

The property value or the default value.

See Also

setProperty.

getPropertyAsInt

```
int getPropertyAsInt(string key);
```

Get a property as an integer. If the property does not exist, 0 is returned.

Parameters

key

The property key.

Return Value

The property value interpreted as an integer.

See Also

setProperty.

getPropertyAsIntWithDefault

```
int getPropertyAsIntWithDefault(string key, int value);
```

Get a property as an integer. If the property does not exist, the given default value is returned.

Parameters

key

The property key.

value

The default value to use if the property does not exist.

Return Value

The property value interpreted as an integer, or the default value.

See Also

setProperty.

getPropertiesForPrefix

```
PropertyDict getPropertiesForPrefix(string prefix);
```

Get all properties whose keys begins with *prefix*. If *prefix* is an empty string, then all properties are returned.

Return Value

The matching property set.

setProperty

```
void setProperty(string key, string value);
```

Set a property. To unset a property, set it to the empty string.

Parameters

key

The property key.

value

The property value.

See Also

getProperty.

getCommandLineOptions

```
StringSeq getCommandLineOptions();
```

Get a sequence of command-line options that is equivalent to this property set. Each element of the returned sequence is a command-line option of the form `--key=value`.

Return Value

The command line options for this property set.

parseCommandLineOptions

```
StringSeq parseCommandLineOptions(string prefix, StringSeq options);
```

Convert a sequence of command-line options into properties. All options that begin with `--prefix`. are converted into properties. If the prefix is empty, all options that begin with `--` are converted to properties.

Parameters

`prefix`

The property prefix, or an empty string to convert all options starting with `--`.
`options`

The command-line options.

Return Value

The command-line options that do not start with the specified prefix, in their original order.

parseIceCommandLineOptions

```
StringSeq parseIceCommandLineOptions(StringSeq options);
```

Convert a sequence of command-line options into properties. All options that begin with one of the following prefixes are converted into properties: `--Ice`, `--IceBox`, `--IceGrid`, `--IcePatch`, `--IcePatch2`, `--IceSSL`, `--IceStorm`, `--Freeze`, `--Glacier`, and `--Glacier2`.

Parameters

options

The command-line options.

Return Value

The command-line options that do not start with one of the listed prefixes, in their original order.

load

```
void load(string file);
```

Load properties from a file.

Parameters

file

The property file.

clone

```
Properties clone();
```

Create a copy of this property set.

Return Value

A copy of this property set.

B.60 Ice::ProtocolException

Overview

```
local exception ProtocolException
```

A generic exception base for all kinds of protocol error conditions.

Derived Exceptions

BadMagicException, CloseConnectionException, CompressionException, ConnectionNotValidatedException, DatagramLimitException, ForcedCloseConnectionException, IllegalMessageSizeException, MarshalException, UnknownMessageException, UnknownReplyStatusException, UnknownRequestIdException, UnsupportedEncodingException, UnsupportedProtocolException.

reason

string reason;

The reason for the failure.

B.61 Ice::ProxyParseException

Overview

Local exception ProxyParseException

This exception is raised if there was an error while parsing a stringified proxy.

str

string str;

The string that could not be parsed.

B.62 Ice::ProxyUnmarshalException

Overview

Local exception ProxyUnmarshalException extends MarshalException

This exception is a specialization of MarshalException that is raised if inconsistent data is received while unmarshaling a proxy.

B.63 Ice::RequestFailedException

Overview

Local exception RequestFailedException

This exception is raised if a request failed. This exception, and all exceptions derived from RequestFailedException, are transmitted by the Ice protocol, even though they are declared local.

Derived Exceptions

FacetNotExistException, ObjectNotExistException, OperationNotExistException.

id

Identity id;

The identity of the Ice Object to which the request was sent.

facet

string facet;

The facet to which the request was sent.

operation

string operation;

The operation name of the request.

B.64 Ice::Router

Overview

interface Router

The Ice router interface. Routers can be set either globally with `Communicator::setDefaultRouter`, or with `ice_router` on specific proxies.

Derived Classes and Interfaces

`::Glacier2::Router`.

`getClientProxy`

`Object* getClientProxy();`

Get the router's client proxy, i.e., the proxy to use for forwarding requests from the client to the router.

Return Value

The router's client proxy.

`getServerProxy`

`Object* getServerProxy();`

Get the router's server proxy, i.e., the proxy to use for forwarding requests from the server to the router.

Return Value

The router's server proxy.

`addProxy`

["deprecate:addProxy() has been deprecated, use addProxies() instead."] `void addProxy(Object* proxy);`

Add new proxy information to the router's routing table.

This operation is deprecated, and only used for old Ice clients (older than version 3.1).

Deprecated

`addProxy()` has been deprecated, use `addProxies()` instead.

Parameters

proxy

The proxy to add.

addProxies

```
ObjectProxySeq addProxies(ObjectProxySeq proxies);
```

Add new proxy information to the router's routing table.

Parameters

proxies

The proxies to add.

Return Value

Proxies discarded by the router.

B.65 **Ice::SecurityException**

Overview

local exception SecurityException

This exception indicates a failure in a security subsystem, such as the IceSSL plugin.

reason

```
string reason;
```

The reason for the failure.

B.66 Ice::ServantLocator

Overview

Local interface `ServantLocator`

The servant locator, which is called by the object adapter to locate a servant that is not found in its active servant map.

Derived Classes and Interfaces

`::Freeze::Evictor`.

Used By

`ObjectAdapter::addServantLocator`, `ObjectAdapter::findServantLocator`.

See Also

`ObjectAdapter`, `ObjectAdapter::addServantLocator`, `ObjectAdapter::findServantLocator`.

locate

```
Object locate(Current curr, out LocalObject cookie);
```

Called by the object adapter before a request is made when a servant cannot be found in the object adapter's active servant map. Note that the object adapter does not automatically insert the returned servant into its active servant map. This must be done by the servant locator implementation, if this is desired.

Important: If you call `locate` from your own code, you must also call `finished` when you have finished using the servant, provided that a non-null servant was returned. Otherwise you will get undefined behavior if you use Servant Locators such as the `::Freeze::Evictor`.

Parameters

`curr`

Information about the current operation for which a servant is required.

`cookie`

A "cookie" that will be passed to `finished`.

Return Value

The located servant, or null if no suitable servant has been found.

See Also

ObjectAdapter, Current, finished.

finished

```
void finished(Current curr, Object servant, LocalObject cookie);
```

Called by the object adapter after a request has been made. This operation is only called if `locate` was called prior to the request and returned a non-null servant. This operation can be used for cleanup purposes after a request.

Parameters

`curr`

Information about the current operation call for which a servant was located by `locate`.

`servant`

The servant that was returned by `locate`.

`cookie`

The cookie that was returned by `locate`.

See Also

ObjectAdapter, Current, locate.

deactivate

```
void deactivate(string category);
```

Called when the object adapter in which this servant locator is installed is deactivated.

Parameters

`category`

Indicates for which category the servant locator is being deactivated.

See Also

`ObjectAdapter::deactivate`, `Communicator::shutdown`,
`Communicator::destroy`.

B.67 `Ice::ServerNotFoundException`

Overview

exception `ServerNotFoundException`

This exception is raised if a server cannot be found.

Used By

`LocatorRegistry::setServerProcessProxy`.

B.68 `Ice::SocketException`

Overview

local exception `SocketException` extends `SyscallException`

This exception is a specialization of `SyscallException` for socket errors.

Derived Exceptions

`ConnectFailedException`, `ConnectionLostException`.

B.69 `Ice::Stats`

Overview

local interface `Stats`

An interface Ice uses to report statistics, such as how much data is sent or received. Applications must provide their own Stats by implementing this interface and installing it in a communicator.

Used By

Communicator::getStats.

bytesSent

```
void bytesSent(string protocol, int num);
```

Callback to report that data has been sent.

Parameters

protocol

The protocol over which data has been sent (for example "tcp", "udp", or "ssl").

num

How many bytes have been sent.

bytesReceived

```
void bytesReceived(string protocol, int num);
```

Callback to report that data has been received.

Parameters

protocol

The protocol over which data has been received (for example "tcp", "udp", or "ssl").

num

How many bytes have been received.

B.70 Ice::StringConversionException

Overview

Local exception `StringConversionException` extends `MarshalException`

This exception is a specialization of `MarshalException` that is raised when a string conversion to or from UTF-8 fails during marshaling or unmarshaling.

B.71 Ice::SyscallException

Overview

Local exception `SyscallException`

This exception is raised if a system error occurred in the server or client process. There are many possible causes for such a system exception. For details on the cause, error should be inspected.

Derived Exceptions

`FileException`, `SocketException`.

`error`

```
int error;
```

The error number describing the system exception. For C++ and Unix, this is equivalent to `errno`. For C++ and Windows, this is the value returned by `GetLastError()` or `WSAGetLastError()`.

B.72 Ice::TimeoutException

Overview

Local exception `TimeoutException`

This exception indicates a timeout condition.

Derived Exceptions

`CloseTimeoutException`, `ConnectTimeoutException`, `ConnectionTimeoutException`.

B.73 `Ice::TwowayOnlyException`

Overview

local exception `TwowayOnlyException`

This exception is raised if an attempt is made to invoke an operation with `ice_oneway`, `ice_batchOneway`, `ice_datagram`, or `ice_batchDatagram` and the operation has a return value, out parameters, or an exception specification.

operation

```
string operation;
```

The name of the operation that was invoked.

B.74 `Ice::UnknownException`

Overview

local exception `UnknownException`

This exception is raised if an operation call on a server raises an unknown exception. For example, for C++, this exception is raised if the server throws a C++ exception that is not directly or indirectly derived from `Ice::LocalException` or `Ice::UserException`.

Derived Exceptions

`UnknownLocalException`, `UnknownUserException`.

unknown

```
string unknown;
```

A textual representation of the unknown exception. This field may or may not be set, depending on the security policy of the server. Some servers may give this information to clients for debugging purposes, while others may not wish to disclose information about server internals.

B.75 `Ice::UnknownLocalException`

Overview

local exception `UnknownLocalException` extends `UnknownException`

This exception is raised if an operation call on a server raises a local exception. Because local exceptions are not transmitted by the Ice protocol, the client receives all local exceptions raised by the server as `UnknownLocalException`. The only exception to this rule are all exceptions derived from `RequestFailedException`, which are transmitted by the Ice protocol even though they are declared local.

B.76 `Ice::UnknownMessageException`

Overview

local exception `UnknownMessageException` extends `ProtocolException`

This exception is a specialization of `ProtocolException`, indicating that an unknown protocol message has been received.

B.77 `Ice::UnknownReplyStatusException`

Overview

Local exception `UnknownReplyStatusException` extends `ProtocolException`

This exception is a specialization of `ProtocolException`, indicating that an unknown reply status has been received.

B.78 `Ice::UnknownRequestIdException`

Overview

Local exception `UnknownRequestIdException` extends `ProtocolException`

This exception is a specialization of `ProtocolException`, indicating that a response for an unknown request id has been received.

B.79 `Ice::UnknownUserException`

Overview

Local exception `UnknownUserException` extends `UnknownException`

This exception is raised if an operation call on a server raises a user exception that is not declared in the exception's `throws` clause. Such undeclared exceptions are not transmitted from the server to the client by the Ice protocol, but instead the client just gets an `UnknownUserException`. This is necessary in order to not violate the contract established by an operation's signature: Only local exceptions and user exceptions declared in the `throws` clause can be raised.

B.80 Ice::UnmarshalOutOfBoundsException

Overview

Local exception `UnmarshalOutOfBoundsException` extends `MarshalException`

This exception is a specialization of `MarshalException` that is raised if an out-of-bounds condition occurs during unmarshaling.

B.81 Ice::UnsupportedEncodingException

Overview

Local exception `UnsupportedEncodingException` extends `ProtocolException`

This exception is a specialization of `ProtocolException`, indicating that an unsupported data encoding version has been encountered.

`badMajor`

```
int badMajor;
```

The major version number of the unsupported encoding.

`badMinor`

```
int badMinor;
```

The minor version number of the unsupported encoding.

`major`

```
int major;
```

The major version number of the encoding that is supported.

`minor`

```
int minor;
```

The highest minor version number of the encoding that can be supported.

B.82 `Ice::UnsupportedProtocolException`

Overview

Local exception `UnsupportedProtocolException` extends `ProtocolException`

This exception is a specialization of `ProtocolException`, indicating that an unsupported protocol version has been encountered.

`badMajor`

```
int badMajor;
```

The major version number of the unsupported protocol.

`badMinor`

```
int badMinor;
```

The minor version number of the unsupported protocol.

`major`

```
int major;
```

The major version number of the protocol that is supported.

`minor`

```
int minor;
```

The highest minor version number of the protocol that can be supported.

B.83 Ice::VersionMismatchException

Overview

Local exception `VersionMismatchException`

This exception is raised if the Ice library version does not match the Ice header files version.

B.84 Freeze

Overview

module `Freeze`

Freeze provides automatic persistence for Ice servants.

Key

sequence<byte> `Key`;

A database key, represented as a sequence of bytes.

Value

sequence<byte> `Value`;

A database value, represented as a sequence of bytes.

B.85 Freeze::CatalogData

Overview

struct `CatalogData`

The catalog keeps information about Freeze Maps and Freeze evictors in a Berkeley Db environment. It is used by `FreezeScript`.

evictor

```
bool evictor;
```

key

```
string key;
```

value

```
string value;
```

B.86 Freeze::Connection

Overview

local interface Connection

A connection to a database (database environment with Berkeley DB). If you want to use a connection concurrently in multiple threads, you need to serialize access to this connection.

beginTransaction

```
Transaction beginTransaction();
```

Create a new transaction. Only one transaction at a time can be associated with a connection.

Return Value

The new transaction

Exceptions

raises

TransactionAlreadyInProgressException if a transaction is already associated with this connection.

currentTransaction

```
Transaction currentTransaction();
```

Returns the transaction associated with this connection.

Return Value

The current transaction if there is one, null otherwise.

close

```
void close();
```

Closes this connection. If there is an associated transaction, it is rolled back.

getCommunicator

```
::Ice::Communicator getCommunicator();
```

Returns the communicator associated with this connection

getName

```
string getName();
```

The name of the connected system (e.g. Berkeley DB environment)

B.87 Freeze::DatabaseException

Overview

local exception DatabaseException

A Freeze database exception.

Derived Exceptions

DeadlockException, NotFoundException.

See Also

DB, Evictor, Connection.

message

string message;

A message describing the reason for the exception.

B.88 Freeze::DeadlockException

Overview

Local exception DeadlockException extends DatabaseException

A Freeze database deadlock exception. Applications can react to this exception by aborting and trying the transaction again.

B.89 Freeze::Evictor

Overview

Local interface Evictor extends ::Ice::ServantLocator

An automatic Ice object persistence manager, based on the evictor pattern. The evictor is a servant locator implementation that stores the persistent state of its objects in a database. Any number of objects can be registered with an evictor, but only a configurable number of servants are active at a time. These active servants reside in a queue; the least recently used servant in the queue is the first to be evicted when a new servant is activated.

See Also

`ServantInitializer`.

setSize

```
void setSize(int sz);
```

Set the size of the evictor's servant queue. This is the maximum number of servants the evictor keeps active. Requests to set the queue size to a value smaller than zero are ignored.

Parameters

`sz`

The size of the servant queue. If the evictor currently holds more than `setSize` servants in its queue, it evicts enough servants to match the new size. Note that this operation can block if the new queue size is smaller than the current number of servants that are servicing requests. In this case, the operation waits until a sufficient number of servants complete their requests.

Exceptions

`EvictorDeactivatedException`

Raised if a the evictor has been deactivated.

See Also

`getSize`.

getSize

```
int getSize();
```

Get the size of the evictor's servant queue.

Return Value

The size of the servant queue.

Exceptions

`EvictorDeactivatedException`

Raised if a the evictor has been deactivated.

See Also

setSize.

add

```
Object* add(Object servant, ::Ice::Identity id);
```

Add a servant to this evictor. The state of the servant passed to this operation will be saved in the evictor's persistent store.

Parameters

servant

The servant to add.

id

The identity of the Ice object that is implemented by the servant.

Return Value

A proxy that matches the given identity and this evictor's object adapter.

Exceptions

`AlreadyRegisteredException`

Raised if the evictor already has an object with this identity.

`DatabaseException`

Raised if a database failure occurred.

`EvictorDeactivatedException`

Raised if the evictor has been deactivated.

See Also

addFacet, remove, removeFacet.

addFacet

```
Object* addFacet(Object servant, ::Ice::Identity id, string facet);
```

Like add, but with a facet. Calling add(servant, id) is equivalent to calling addFacet with an empty facet.

Parameters

servant

The servant to add.

id

The identity of the Ice object that is implemented by the servant.

facet

The facet. An empty facet means the default facet.

Return Value

A proxy that matches the given identity and this evictor's object adapter.

Exceptions

`AlreadyRegisteredException`

Raised if the evictor already has an object with this identity.

`DatabaseException`

Raised if a database failure occurred.

`EvictorDeactivatedException`

Raised if the evictor has been deactivated.

See Also

`add`, `remove`, `removeFacet`.

`remove`

```
Object remove(::Ice::Identity id);
```

Permanently destroy an Ice object.

Parameters

id

The identity of the Ice object.

Return Value

The removed servant.

Exceptions

`NotRegisteredException`

Raised if this identity was not registered with the evictor.

`DatabaseException`

Raised if a database failure occurred.

`EvictorDeactivatedException`

Raised if the evictor has been deactivated.

See Also

`add`, `removeFacet`.

removeFacet

```
Object removeFacet(::Ice::Identity id, string facet);
```

Like `remove`, but with a facet. Calling `remove(id)` is equivalent to calling `removeFacet` with an empty facet.

Parameters

`id`

The identity of the Ice object.

`facet`

The facet. An empty facet means the default facet.

Return Value

The removed servant.

Exceptions

`NotRegisteredException`

Raised if this identity was not registered with the evictor.

`DatabaseException`

Raised if a database failure occurred.

`EvictorDeactivatedException`

Raised if the evictor has been deactivated.

See Also

remove, addFacet.

keep

```
void keep(::Ice::Identity id);
```

Lock this object in the evictor cache. This lock can be released by `release` or `remove`. `release` releases only one lock, while `remove` releases all the locks.

Parameters

`id`

The identity of the Ice object.

Exceptions

`NotRegisteredException`

Raised if this identity was not registered with the evictor.

`DatabaseException`

Raised if a database failure occurred.

See Also

keepFacet, release, remove.

keepFacet

```
void keepFacet(::Ice::Identity id, string facet);
```

Like `keep`, but with a facet. Calling `keep(id)` is equivalent to calling `keepFacet` with an empty facet.

Parameters

`id`

The identity of the Ice object.

`facet`

The facet. An empty facet means the default facet.

Exceptions

`NotRegisteredException`

Raised if this identity was not registered with the evictor.

`DatabaseException`

Raised if a database failure occurred.

See Also

`keep`, `releaseFacet`, `removeFacet`.

release

```
void release(::Ice::Identity id);
```

Release a "lock" acquired by `keep`. Once all the locks on an object have been released, the object is again subject to the normal eviction strategy.

Parameters

`id`

The identity of the Ice object.

Exceptions

`NotRegisteredException`

Raised if this object was not "locked" with `keep` or `keepFacet`.

See Also

`keepFacet`, `release`.

releaseFacet

```
void releaseFacet(::Ice::Identity id, string facet);
```

Like `release`, but with a facet. Calling `release(id)` is equivalent to calling `releaseFacet` with an empty facet.

Parameters

`id`

The identity of the Ice object.

facet

The facet. An empty facet means the default facet.

Exceptions

`NotRegisteredException`

Raised if this object was not "locked" with `keep` or `keepFacet`.

See Also

`keep`, `releaseFacet`.

`hasObject`

```
bool hasObject(::Ice::Identity id);
```

Returns true if the given identity is managed by the evictor with the default facet.

Return Value

true if the identity is managed by the evictor, false otherwise.

Exceptions

`DatabaseException`

Raised if a database failure occurred.

`EvictorDeactivatedException`

Raised if a the evictor has been deactivated.

`hasFacet`

```
bool hasFacet(::Ice::Identity id, string facet);
```

Like `hasObject`, but with a facet. Calling `hasObject(id)` is equivalent to calling `hasFacet` with an empty facet.

Return Value

true if the identity is managed by the evictor for the given facet, false otherwise.

Exceptions

DatabaseException

Raised if a database failure occurred.

EvictorDeactivatedException

Raised if a the evictor has been deactivated.

getIterator

```
EvictorIterator getIterator(string facet, int batchSize);
```

Get an iterator for the identities managed by the evictor.

Parameters

facet

The facet. An empty facet means the default facet.

batchSize

Internally, the Iterator retrieves the identities in batches of size batchSize. Selecting a small batchSize can have an adverse effect on performance.

Return Value

A new iterator.

Exceptions

EvictorDeactivatedException

Raised if a the evictor has been deactivated.

createObject

```
[ "deprecate:createObject() has been deprecated, use add()  
instead." ] void createObject(::Ice::Identity id, Object servant);
```

Add or update a servant. The state of the servant passed to this operation will be saved in the evictor's persistent store. This operation is deprecated and will be removed in a future release. It is recommended to use add instead.

Deprecated

`createObject()` has been deprecated, use `add()` instead.

Parameters

`id`

The identity of the Ice object that is implemented by the servant.

`servant`

The servant to add.

Exceptions

`DatabaseException`

Raised if a database failure occurred.

`EvictorDeactivatedException`

Raised if the evictor has been deactivated.

See Also

`add`, `destroyObject`.

`destroyObject`

```
[ "deprecate:destroyObject() has been deprecated, use remove() instead." ] void destroyObject(::Ice::Identity id);
```

Permanently destroy an Ice object. Like `remove`, except `destroyObject` does not raise any exception when the object does not exist. This operation is deprecated and will be removed in a future release. It is recommended to use `remove` instead.

Deprecated

`destroyObject()` has been deprecated, use `remove()` instead.

Parameters

`id`

The identity of the Ice object.

Exceptions

DatabaseException

Raised if a database failure occurred.

EvictorDeactivatedException

Raised if the evictor has been deactivated.

See Also

remove, createObject.

B.90 `Freeze::EvictorDeactivatedException`

Overview

local exception `EvictorDeactivatedException`

This exception is raised if the evictor has been deactivated.

B.91 `Freeze::EvictorIterator`

Overview

local interface `EvictorIterator`

An iterator for the objects managed by the evictor. Note that an `EvictorIterator` is not thread-safe: the application needs to serialize access to a given `EvictorIterator`, for example by using it in just one thread.

Used By

`Evictor::getIterator`.

See Also

`Evictor`.

hasNext

```
bool hasNext();
```

Determines if the iteration has more elements.

Return Value

True if the iterator has more elements, false otherwise.

Exceptions

DatabaseException

Raised if a database failure occurs while retrieving a batch of objects.

next

```
::Ice::Identity next();
```

Obtains the next identity in the iteration.

Return Value

s The next identity in the iteration.

Exceptions

NoSuchElementException

Raised if there is no further elements in the iteration.

DatabaseException

Raised if a database failure occurs while retrieving a batch of objects.

B.92 Freeze::InvalidPositionException

Overview

local exception InvalidPositionException

This Freeze Iterator is not on a valid position, for example this position has been erased.

B.93 Freeze::NoSuchElementException

Overview

Local exception NoSuchElementException

This exception is raised if there are no further elements in the iteration.

B.94 Freeze::NotFoundException

Overview

Local exception NotFoundException extends DatabaseException

A Freeze database exception, indicating that a database record could not be found.

B.95 Freeze::ObjectRecord

Overview

struct ObjectRecord

The evictor uses a number of maps ::Ice::Identity to ObjectRecord as its persistent storage.

servant

Object servant;

stats

Statistics stats;

B.96 Freeze::ServantInitializer

Overview

Local interface `ServantInitializer`

A servant initializer is installed in an evictor and provides the application with an opportunity to perform custom servant initialization.

See Also

`Evictor`.

`initialize`

```
void initialize(::Ice::ObjectAdapter adapter, ::Ice::Identity  
identity, string facet, Object servant);
```

Called whenever the evictor creates a new servant. This operation allows application code to perform custom servant initialization after the servant has been created by the evictor and its persistent state has been restored.

Parameters

`adapter`

The object adapter in which the evictor is installed.

`identity`

The identity of the Ice object for which the servant was created.

`facet`

The facet. An empty facet means the default facet.

`servant`

The servant to initialize.

See Also

`::Ice::Identity`.

B.97 Freeze::Statistics

Overview

```
struct Statistics
```

The evictor maintains statistics about each object.

Used By

```
ObjectRecord::stats.
```

creationTime

```
long creationTime;
```

The time the object was created, in milliseconds since Jan 1, 1970 0:00.

lastSaveTime

```
long lastSaveTime;
```

The time the object was last saved, in milliseconds relative to `creationTime`.

avgSaveTime

```
long avgSaveTime;
```

The average time between saves, in milliseconds.

B.98 Freeze::Transaction

Overview

```
local interface Transaction
```

A transaction. If you want to use a transaction concurrently in multiple threads, you need to serialize access to this transaction.

Used By

Connection::beginTransaction, Connection::currentTransaction.

commit

```
void commit();
```

Commit this transaction.

rollback

```
void rollback();
```

Roll back this transaction.

B.99 Freeze::TransactionAlreadyInProgressException

Overview

Local exception TransactionAlreadyInProgressException

B.100 IceBox

Overview

```
module IceBox
```

IceBox is an application server specifically for Ice applications. IceBox can easily run and administer Ice services that are dynamically loaded as a DLL, shared library, or Java class.

B.101 `IceBox::FailureException`

Overview

local exception `FailureException`

Indicates a failure occurred. For example, if a service encounters an error during initialization, or if the service manager is unable to load a service executable.

`reason`

string `reason`;

The reason for the failure.

B.102 `IceBox::Service`

Overview

local interface `Service`

An application service managed by a `ServiceManager`.

`start`

```
void start(string name, ::Ice::Communicator communicator,  
           ::Ice::StringSeq args);
```

Start the service. The given communicator is created by the `ServiceManager` for use by the service. This communicator may also be used by other services, depending on the service configuration.

The `ServiceManager` owns this communicator, and is responsible for destroying it.

Parameters

`name`

The service's name, as determined by the configuration.

communicator

A communicator for use by the service.

args

The service arguments that were not converted into properties.

Exceptions

FailureException

Raised if start failed.

stop

```
void stop();
```

Stop the service.

B.103 IceBox::ServiceManager

Overview

interface ServiceManager

Administers a set of Service instances.

See Also

Service.

getSliceChecksums

```
::Ice::SliceChecksumDict getSliceChecksums();
```

Returns the checksums for the IceBox Slice definitions.

Return Value

A dictionary mapping Slice type ids to their checksums.

shutdown

```
void shutdown();
```

Shutdown all services. This will cause `Service::stop` to be invoked on all configured services.

B.104 Glacier2

Overview

```
module Glacier2
```

Glacier2 is a firewall solution for Ice. Glacier2 authenticates and filters client requests and allows callbacks to the client in a secure fashion. In combination with IceSSL, Glacier2 provides a security solution that is both non-intrusive and easy to configure.

B.105 Glacier2::Admin

Overview

```
interface Admin
```

The Glacier2 administrative interface. This must only be accessible from inside the firewall.

shutdown

```
void shutdown();
```

Shut down the Glacier2 router.

B.106 `Glacier2::CannotCreateSessionException`

Overview

exception `CannotCreateSessionException`

This exception is raised if an attempt to create a new session failed.

Used By

`Router::createSession`, `Router::createSessionFromSecureConnection`,
`SSLSessionManager::create`, `SessionManager::create`.

See Also

`Router::createSession`, `SessionManager::createSession`.

reason

string reason;

The reason why session creation has failed.

B.107 `Glacier2::IdentitySet`

Overview

interface `IdentitySet`

An object for managing the set of object identity constraints on a `Session`.

See Also

`Session`, `SessionControl`.

add

```
void add(::Ice::IdentitySeq additions);
```

Add a sequence of Ice identities to this set of constraints. Order is not preserved and duplicates are implicitly removed.

Parameters

additions

The sequence of Ice identities to be added.

remove

```
void remove(::Ice::IdentitySeq deletions);
```

Remove a sequence of identities from this set of constraints. No errors are returned if an entry is not found.

Parameters

deletions

The sequence of Ice identities to be removed.

get

```
::Ice::IdentitySeq get();
```

Returns a sequence of identities describing the constraints in this set.

Return Value

The sequence of Ice identities for this set.

B.108 `Glacier2::PermissionDeniedException`

Overview

exception `PermissionDeniedException`

This exception is raised if a client is denied the ability to create a session with the router.

Used By

`Router::createSession`, `Router::createSessionFromSecureConnection`.

See Also

`Router::createSession`.

reason

string reason;

The reason why permission was denied.

B.109 `Glacier2::PermissionsVerifier`

Overview

interface `PermissionsVerifier`

The Glacier2 permissions verifier. This is called through the process of establishing a session.

See Also

`Router`.

checkPermissions

```
bool checkPermissions(string userId, string password, out string reason);
```

Check whether a user has permission to access the router.

Parameters

userId

The user id for which to check permission.

password

The user's password.

reason

The reason why access was denied.

Return Value

True if access is granted, or false otherwise.

B.110 Glacier2::Router

Overview

interface Router extends ::Ice::Router

The Glacier2 specialization of the standard Ice router interface.

getCategoryForClient

```
string getCategoryForClient();
```

This category must be used in the identities of all of the client's callback objects. This is necessary in order for the router to forward callback requests to the intended client.

Return Value

The category.

createSession

```
Session* createSession(string userId, string password) throws  
PermissionDeniedException, CannotCreateSessionException;
```

Create a per-client session with the router. If a `SessionManager` has been installed, a proxy to a `Session` object is returned to the client. Otherwise, null is returned and only an internal session (i.e., not visible to the client) is created. If a session proxy is returned, it must be configured to route through the router that created it. This will happen automatically if the router is configured as the client's default router at the time the session proxy is created in the client process, otherwise the client must configure the session proxy explicitly.

Parameters

`userId`

The user id for which to check the password.

`password`

The password for the given user id.

Return Value

A proxy for the newly created session, or null if no `SessionManager` has been installed.

Exceptions

`PermissionDeniedException`

Raised if the password for the given user id is not correct, or if the user is not allowed access.

`CannotCreateSessionException`

Raised if the session cannot be created.

See Also

`Session`, `SessionManager`, `PermissionsVerifier`.

`createSessionFromSecureConnection`

`Session* createSessionFromSecureConnection() throws
PermissionDeniedException, CannotCreateSessionException;`

Create a per-client session with the router. The user is authenticated through the SSL certificates that have been associated with the connection. If a `SessionManager` has been installed, a proxy to a `Session` object is returned to the client. Otherwise, null is returned and only an internal session (i.e., not visible to the client) is created. If a session proxy is returned, it must be configured to route through the router that created it. This will happen automatically if the router is configured as the client's default router at the time the session proxy is created in the client process, otherwise the client must configure the session proxy explicitly.

Return Value

A proxy for the newly created session, or null if no `SessionManager` has been installed.

Exceptions

`PermissionDeniedException`

Raised if the user cannot be authenticated or if the user is not allowed access.

`CannotCreateSessionException`

Raised if the session cannot be created.

See Also

`Session`, `SessionManager`, `PermissionsVerifier`.

destroySession

`void destroySession() throws SessionNotExistException;`

Destroy the calling client's session with this router.

Exceptions

`SessionNotExistException`

Raised if no session exists for the calling client.

getSessionTimeout

`long getSessionTimeout();`

Get the value of the session timeout. Sessions are destroyed if they see no activity for this period of time.

Return Value

The timeout (in seconds).

B.111 `Glacier2::SSLInfo`

Overview

`struct SSLInfo`

Information taken from an SSL connection used for permissions verification.

Used By

SSLPermissionsVerifier::authorize, SSLSessionManager::create.

See Also

PermissionsVerifier.

remoteHost

```
string remoteHost;
```

The remote host.

remotePort

```
int remotePort;
```

The remote port.

localHost

```
string localHost;
```

The router's host.

localPort

```
int localPort;
```

The router's port.

cipher

```
string cipher;
```

The negotiated cipher suite.

certs

```
::Ice::StringSeq certs;
```

The certificate chain.

B.112 `Glacier2::SSLPermissionsVerifier`

Overview

```
interface SSLPermissionsVerifier
```

The SSL Glacier2 permissions verifier. This is called through the process of establishing a session.

See Also

Router.

`authorize`

```
bool authorize(SSLInfo info, out string reason);
```

Check whether a user has permission to access the router.

Parameters

`info`

The SSL information.

`reason`

The reason why access was denied.

Return Value

True if access is granted, or false otherwise.

See Also

SSLInfo.

B.113 `Glacier2::SSLSessionManager`

Overview

interface `SSLSessionManager`

The session manager for SSL authenticated users that is responsible for managing `Session` objects. New session objects are created by the `Router` object calling on an application-provided session manager. If no session manager is provided by the application, no client-visible sessions are passed to the client.

See Also

`Router`, `Session`.

create

`Session* create(SSLInfo info, SessionControl* control)` throws `CannotCreateSessionException`;

Create a new session.

Parameters

`info`

The SSL info.

`control`

A proxy to the session control object.

Return Value

A proxy to the newly created session.

Exceptions

`CannotCreateSessionException`

Raised if the session cannot be created.

B.114 Glacier2::Session

Overview

interface Session

A client-visible session object, which is tied to the lifecycle of a Router.

Derived Classes and Interfaces

::IceGrid::AdminSession, ::IceGrid::Session.

See Also

Router, SessionManager.

destroy

void destroy();

Destroy the session. This is called automatically when the Router is destroyed.

B.115 Glacier2::SessionControl

Overview

interface SessionControl

An administrative session control object, which is tied to the lifecycle of a Session.

See Also

Session.

categories

StringSet* categories();

Access the object that manages the allowable categories for object identities for this session.

Return Value

A `StringSet` object

adapterIds

```
StringSet* adapterIds();
```

Access the object that manages the allowable adapter identities for objects for this session.

Return Value

A `StringSet` object

identities

```
IdentitySet* identities();
```

Access the object that manages the allowable object identities for this session.

Return Value

An `IdentitySet` object

destroy

```
[ "ami" ] void destroy();
```

Destroy the associated session.

B.116 `Glacier2::SessionManager`

Overview

```
interface SessionManager
```

The session manager for username/password authenticated users that is responsible for managing `Session` objects. New session objects are created by the `Router` object calling on an application-provided session manager. If no session manager is provided by the application, no client-visible sessions are passed to the client.

See Also

`Router`, `Session`.

create

`Session* create(string userId, SessionControl* control) throws CannotCreateSessionException;`

Create a new session.

Parameters

`userId`

The user id for the session.

`control`

A proxy to the session control object.

Return Value

A proxy to the newly created session.

Exceptions

`CannotCreateSessionException`

Raised if the session cannot be created.

B.117 `Glacier2::SessionNotExistException`

Overview

exception `SessionNotExistException`

This exception is raised if a client tries to destroy a session with a router, but no session exists for the client.

Used By

`Router::destroySession`.

See Also

`Router::destroySession`.

B.118 `Glacier2::StringSet`

Overview

interface `StringSet`

An object for managing the set of identity constraints for specific parts of object identity on a `Session`.

See Also

`Session`, `SessionControl`.

add

```
void add(::Ice::StringSeq additions);
```

Add a sequence of strings to this set of constraints. Order is not preserved and duplicates are implicitly removed.

Parameters

`additions`

The sequence of strings to be added.

remove

```
void remove(::Ice::StringSeq deletions);
```

Remove a sequence of strings from this set of constraints. No errors are returned if an entry is not found.

Parameters

deletions

The sequence of strings to be removed.

get

```
::Ice::StringSeq get();
```

Returns a sequence of strings describing the constraints in this set.

Return Value

The sequence of strings for this set.

B.119 IceGrid

Overview

```
module IceGrid
```

IceGrid is a server activation and deployment tool. IceGrid, simplifies the complex task of deploying applications in a heterogeneous computer network.

AdapterDescriptorSeq

```
[ "java:type:{java.util.LinkedList}" ] sequence<AdapterDescriptor>  
AdapterDescriptorSeq;
```

A sequence of adapter descriptors.

Used By

CommunicatorDescriptor::adapters.

AdapterDynamicInfoSeq

```
[ "java:type:{java.util.LinkedList}" ]  
sequence<AdapterDynamicInfo> AdapterDynamicInfoSeq;
```

A sequence of adapter dynamic information structures.

Used By

NodeDynamicInfo::adapters.

AdapterInfoSeq

```
sequence<AdapterInfo> AdapterInfoSeq;
```

A sequence of adapter information structures.

Used By

Admin::getAdapterInfo, RegistryObserver::init.

ApplicationDescriptorSeq

```
[ "java:type:{java.util.LinkedList}" ]  
sequence<ApplicationDescriptor> ApplicationDescriptorSeq;
```

A sequence of application descriptors.

Used By

RegistryObserver::init.

DbEnvDescriptorSeq

```
[ "java:type:{java.util.LinkedList}" ] sequence<DbEnvDescriptor>  
DbEnvDescriptorSeq;
```

A sequence of database environment descriptors.

Used By

CommunicatorDescriptor::dbEnvs.

NodeDynamicInfoSeq

sequence<NodeDynamicInfo> NodeDynamicInfoSeq;

A sequence of node dynamic information structures.

Used By

NodeObserver::init.

NodeUpdateDescriptorSeq

["java:type:{java.util.LinkedList}"]
sequence<NodeUpdateDescriptor> NodeUpdateDescriptorSeq;

A sequence of node update descriptors.

Used By

ApplicationUpdateDescriptor::nodes.

ObjectDescriptorSeq

["java:type:{java.util.LinkedList}"] sequence<ObjectDescriptor>
ObjectDescriptorSeq;

A sequence of object descriptors.

Used By

AdapterDescriptor::allocatables, AdapterDescriptor::objects, ReplicaGroupDescriptor::objects.

ObjectInfoSeq

sequence<ObjectInfo> ObjectInfoSeq;

A sequence of object information structures.

Used By

Admin::getAllObjectInfos, Admin::getObjectInfosByType, RegistryObserver::init.

PropertyDescriptorSeq

```
[ "java:type:{java.util.LinkedList}" ]  
sequence<PropertyDescriptor> PropertyDescriptorSeq;
```

A sequence of property descriptors.

Used By

DbEnvDescriptor::properties, PropertySetDescriptor::properties.

ReplicaGroupDescriptorSeq

```
[ "java:type:{java.util.LinkedList}" ]  
sequence<ReplicaGroupDescriptor> ReplicaGroupDescriptorSeq;
```

A sequence of replica groups.

Used By

ApplicationDescriptor::replicaGroups, ApplicationUpdateDescriptor::replicaGroups.

ServerDescriptorSeq

```
[ "java:type:{java.util.LinkedList}" ] sequence<ServerDescriptor>  
ServerDescriptorSeq;
```

A sequence of server descriptors.

Used By

NodeDescriptor::servers, NodeUpdateDescriptor::servers.

ServerDynamicInfoSeq

```
[ "java:type:{java.util.LinkedList}" ] sequence<ServerDynamicInfo>  
ServerDynamicInfoSeq;
```

A sequence of server dynamic information structures.

Used By

NodeDynamicInfo::servers.

ServerInstanceDescriptorSeq

```
[ "java:type:{java.util.LinkedList}" ]  
sequence<ServerInstanceDescriptor> ServerInstanceDescriptorSeq;
```

A sequence of server instance descriptors.

Used By

NodeDescriptor::serverInstances, NodeUpdateDescriptor::serverInstances.

ServiceDescriptorSeq

```
[ "java:type:{java.util.LinkedList}" ] sequence<ServiceDescriptor>  
ServiceDescriptorSeq;
```

A sequence of service descriptors.

ServiceInstanceDescriptorSeq

```
[ "java:type:{java.util.LinkedList}" ]  
sequence<ServiceInstanceDescriptor> ServiceInstanceDescriptorSeq;
```

A sequence of service instance descriptors.

Used By

IceBoxDescriptor::services.

NodeDescriptorDict

```
dictionary<string, NodeDescriptor> NodeDescriptorDict;
```

Mapping of node name to node descriptor.

Used By

ApplicationDescriptor::nodes.

PropertySetDescriptorDict

```
dictionary<string, PropertySetDescriptor>  
PropertySetDescriptorDict;
```

A mapping of property set name to property set descriptor.

Used By

ApplicationDescriptor::propertySets, NodeDescriptor::propertySets, NodeUpdateDescriptor::propertySets, ApplicationUpdateDescriptor::propertySets.

StringObjectProxyDict

dictionary<string, Object*> StringObjectProxyDict;

A dictionary of proxies.

StringStringDict

dictionary<string, string> StringStringDict;

A mapping of string to string.

Used By

ApplicationDescriptor::variables, NodeDescriptor::variables, NodeUpdateDescriptor::variables, TemplateDescriptor::parameterDefaults, ApplicationUpdateDescriptor::variables, ServiceInstanceDescriptor::parameterValues, ServerInstanceDescriptor::parameterValues.

TemplateDescriptorDict

dictionary<string, TemplateDescriptor> TemplateDescriptorDict;

A mapping of template identifier to template descriptor.

Used By

ApplicationUpdateDescriptor::serverTemplates, ApplicationUpdateDescriptor::serviceTemplates, ApplicationDescriptor::serverTemplates, ApplicationDescriptor::serviceTemplates.

B.120 IceGrid::AccessDeniedException

Overview

exception AccessDeniedException

This exception is raised if an operation can't be performed because the registry lock wasn't acquired or is already acquired by a session.

Used By

Admin::addApplication, Admin::instantiateServer, Admin::removeApplication, Admin::syncApplication, Admin::updateApplication, AdminSession::update, AdminSession::finishUpdate, AdminSession::startUpdate.

lockUserId

string lockUserId;

B.121 IceGrid::AdapterDescriptor

Overview

struct AdapterDescriptor

An Ice object adapter descriptor.

Used By

AdapterDescriptorSeq.

name

string name;

The object adapter name.

description

```
string description;
```

The description of this object adapter.

id

```
string id;
```

The object adapter id.

replicaGroupId

```
string replicaGroupId;
```

The replica id of this adapter.

registerProcess

```
bool registerProcess;
```

Flag to specify if the object adapter will register a process object.

waitForActivation

```
bool waitForActivation;
```

If true the activator will wait for this object adapter activation to mark the server as active.

objects

```
ObjectDescriptorSeq objects;
```

The well-known object descriptors associated with this object adapter.

allocatables

```
ObjectDescriptorSeq allocatables;
```

The allocatable object descriptors associated with this object adapter.

B.122 IceGrid::AdapterDynamicInfo

Overview

struct AdapterDynamicInfo

Dynamic information about the state of an adapter.

Used By

AdapterDynamicInfoSeq, NodeObserver::updateAdapter.

id

string id;

The id of the adapter.

proxy

Object* proxy;

The direct proxy containing the adapter endpoints.

B.123 IceGrid::AdapterInfo

Overview

struct AdapterInfo

Information about an adapter registered with the IceGrid registry.

Used By

AdapterInfoSeq, RegistryObserver::adapterAdded, RegistryObserver::adapterUpdated.

id

string id;

The id of the adapter.

proxy

Object* proxy;

A dummy direct proxy that contains the adapter endpoints.

replicaGroupId

string replicaGroupId;

The replica group id of the object adapter, or empty if the adapter doesn't belong to a replica group.

B.124 `IceGrid::AdapterNotExistException`

Overview

exception AdapterNotExistException

This exception is raised if an adapter does not exist.

Used By

Admin::getAdapterInfo, Admin::removeAdapter.

id

string id;

The id of the object adapter.

B.125 `IceGrid::AdaptiveLoadBalancingPolicy`

Overview

class AdaptiveLoadBalancingPolicy extends LoadBalancingPolicy

Adaptive load balancing policy.

loadSample

```
string loadSample;
```

The load sample to use for the load balancing. The allowed values for this attribute are "1", "5" and "15", representing respectively the load average over the past minute, the past 5 minutes and the past 15 minutes.

B.126 IceGrid::Admin

Overview

```
interface Admin
```

The IceGrid administrative interface.

Warning: *Allowing access to this interface is a security risk! Please see the IceGrid documentation for further information.*

addApplication

```
void addApplication(ApplicationDescriptor descriptor) throws  
AccessDeniedException, DeploymentException;
```

Add an application to IceGrid.

Parameters

```
descriptor
```

The application descriptor.

Exceptions

```
AccessDeniedException
```

Raised if the session doesn't hold the exclusive lock or if another session is holding the lock.

```
DeploymentException
```

Raised if application deployment failed.

syncApplication

void syncApplication(ApplicationDescriptor descriptor) throws
AccessDeniedException, DeploymentException,
ApplicationNotExistException;

Synchronize a deployed application with the given application descriptor. This operation will replace the current descriptor with this new descriptor.

Parameters

descriptor

The application descriptor.

Exceptions

AccessDeniedException

Raised if the session doesn't hold the exclusive lock or if another session is holding the lock.

DeploymentException

Raised if application deployment failed.

ApplicationNotExistException

Raised if the application doesn't exist.

updateApplication

void updateApplication(ApplicationUpdateDescriptor descriptor)
throws AccessDeniedException, DeploymentException,
ApplicationNotExistException;

Update a deployed application with the given update application descriptor.

Parameters

descriptor

The update descriptor.

Exceptions

AccessDeniedException

Raised if the session doesn't hold the exclusive lock or if another session is holding the lock.

DeploymentException

Raised if application deployment failed.

ApplicationNotExistException

Raised if the application doesn't exist.

removeApplication

`void removeApplication(string name) throws AccessDeniedException, ApplicationNotExistException;`

Remove an application from IceGrid.

Parameters

name

The application name.

Exceptions

AccessDeniedException

Raised if the session doesn't hold the exclusive lock or if another session is holding the lock.

ApplicationNotExistException

Raised if the application doesn't exist.

instantiateServer

`void instantiateServer(string application, string node, ServerInstanceDescriptor desc) throws AccessDeniedException, ApplicationNotExistException, DeploymentException;`

Instantiate a server template from an application on the given node.

Parameters

application

The application name.

node

The name of the node where the server will be deployed.

desc

The descriptor of the server instance to deploy.

Exceptions

`AccessDeniedException`

Raised if the session doesn't hold the exclusive lock or if another session is holding the lock.

`DeploymentException`

Raised if server instantiation failed.

`ApplicationNotExistException`

Raised if the application doesn't exist.

patchApplication

```
[ "ami", "amd" ] void patchApplication(string name, bool shutdown)
throws ApplicationNotExistException, PatchException;
```

Patch the given application data.

Parameters

name

The application name.

shutdown

If true, the servers depending on the data to patch will be shutdown if necessary.

Exceptions

`ApplicationNotExistException`

Raised if the application doesn't exist.

`PatchException`

Raised if the patch failed.

getApplicationDescriptor

```
ApplicationDescriptor getApplicationDescriptor(string name) throws
ApplicationNotExistException;
```

Get an application descriptor.

Parameters

name

The application name.

Return Value

The application descriptor.

Exceptions

ApplicationNotExistException

Raised if the application doesn't exist.

getDefaultApplicationDescriptor

ApplicationDescriptor getDefaultApplicationDescriptor() throws DeploymentException;

Get the default application descriptor.

Exceptions

DeploymentException

Raised if the default application descriptor can't be accessed or is invalid.

getAllApplicationNames

::Ice::StringSeq getAllApplicationNames();

Get all the IceGrid applications currently registered.

Return Value

The application names.

getServerInfo

ServerInfo getServerInfo(string id) throws ServerNotExistException;

Get the server information for the server with the given id.

Parameters

id

The server id.

Return Value

The server information.

Exceptions

ServerNotExistException

Raised if the server doesn't exist.

getServerState

ServerState getServerState(string id) throws
ServerNotExistException, NodeUnreachableException,
DeploymentException;

Get a server's state.

Parameters

id

The server id.

Return Value

The server state.

Exceptions

ServerNotExistException

Raised if the server doesn't exist.

NodeUnreachableException

Raised if the node could not be reached.

DeploymentException

Raised if the server couldn't be deployed on the node.

getServerPid

`int getServerPid(string id) throws ServerNotExistException, NodeUnreachableException, DeploymentException;`

Get a server's system process id. The process id is operating system dependent.

Parameters

`id`

The server id.

Return Value

The server's process id.

Exceptions

`ServerNotExistException`

Raised if the server doesn't exist.

`NodeUnreachableException`

Raised if the node could not be reached.

`DeploymentException`

Raised if the server couldn't be deployed on the node.

enableServer

`["ami"] void enableServer(string id, bool enabled) throws ServerNotExistException, NodeUnreachableException, DeploymentException;`

Enable or disable a server. A disabled server can't be started on demand or administratively. The enable state of the server is not persistent: if the node is shutdown and restarted, the server will be enabled by default.

Parameters

`id`

The server id.

`enabled`

True to enable the server, false to disable it.

Exceptions

ServerNotExistException

Raised if the server doesn't exist.

NodeUnreachableException

Raised if the node could not be reached.

DeploymentException

Raised if the server couldn't be deployed on the node.

isServerEnabled

```
bool isServerEnabled(string id) throws ServerNotExistException,  
NodeUnreachableException, DeploymentException;
```

Check if the server is enabled or disabled.

Parameters

id

The server id.

Exceptions

ServerNotExistException

Raised if the server doesn't exist.

NodeUnreachableException

Raised if the node could not be reached.

DeploymentException

Raised if the server couldn't be deployed on the node.

startServer

```
[ "ami" ] void startServer(string id) throws  
ServerNotExistException, ServerStartException,  
NodeUnreachableException, DeploymentException;
```

Start a server and wait for its activation.

Parameters

id

The server id.

Return Value

True if the server was successfully started, false otherwise.

Exceptions

`ServerNotExistException`

Raised if the server doesn't exist.

`ServerStartException`

Raised if the server couldn't be started.

`NodeUnreachableException`

Raised if the node could not be reached.

`DeploymentException`

Raised if the server couldn't be deployed on the node.

stopServer

```
[ "ami" ] void stopServer(string id) throws  
ServerNotExistException, ServerStopException,  
NodeUnreachableException, DeploymentException;
```

Stop a server.

Parameters

id

The server id.

Exceptions

`ServerNotExistException`

Raised if the server doesn't exist.

`ServerStopException`

Raised if the server couldn't be stopped.

`NodeUnreachableException`

Raised if the node could not be reached.

`DeploymentException`

Raised if the server couldn't be deployed on the node.

`patchServer`

```
[ "ami", "amd" ] void patchServer(string id, bool shutdown) throws  
ServerNotExistException, NodeUnreachableException,  
DeploymentException, PatchException;
```

Patch a server.

Parameters

`id`

The server id.

`shutdown`

If true, servers depending on the data to patch will be shutdown if necessary.

Exceptions

`ServerNotExistException`

Raised if the server doesn't exist.

`NodeUnreachableException`

Raised if the node could not be reached.

`DeploymentException`

Raised if the server couldn't be deployed on the node.

`PatchException`

Raised if the patch failed.

`sendSignal`

```
void sendSignal(string id, string signal) throws  
ServerNotExistException, NodeUnreachableException,  
DeploymentException, BadSignalException;
```

Send signal to a server.

Parameters

`id`

The server id.

`signal`

The signal, for example SIGTERM or 15.

Exceptions

`ServerNotExistException`

Raised if the server doesn't exist.

`NodeUnreachableException`

Raised if the node could not be reached.

`DeploymentException`

Raised if the server couldn't be deployed on the node.

`BadSignalException`

Raised if the signal is not recognized by the target server.

writeMessage

```
void writeMessage(string id, string message, int fd) throws  
ServerNotExistException, NodeUnreachableException,  
DeploymentException;
```

Write message on server stdout or stderr.

Parameters

`id`

The server id.

`message`

The message.

`fd`

1 for stdout, 2 for stderr.

Exceptions

`ServerNotExistException`

Raised if the server doesn't exist.

`NodeUnreachableException`

Raised if the node could not be reached.

`DeploymentException`

Raised if the server couldn't be deployed on the node.

`getAllServerIds`

```
::Ice::StringSeq getAllServerIds();
```

Get all the server ids registered with IceGrid.

Return Value

The server ids.

`getAdapterInfo`

```
AdapterInfoSeq getAdapterInfo(string id) throws  
AdapterNotExistException;
```

Get the adapter information for the replica group or adapter with the given id.

Parameters

`adapterId`

The adapter id.

Return Value

A sequence of adapter information structures. If the given id refers to an adapter, this sequence will contain only one element. If the given id refers to a replica group, the sequence will contain the adapter information of each member of the replica group.

Exceptions

`AdapterNotExistException`

Raised if the adapter or replica group doesn't exist.

removeAdapter

```
[ "ami" ] void removeAdapter(string adapterId) throws  
AdapterNotExistException, DeploymentException;
```

Remove the adapter with the given id.

Exceptions

`AdapterNotExistException`

Raised if the adapter doesn't exist.

getAllAdapterIds

```
::Ice::StringSeq getAllAdapterIds();
```

Get all the adapter ids registered with IceGrid.

Return Value

The adapter ids.

addObject

```
void addObject(Object* obj) throws ObjectExistsException,  
DeploymentException;
```

Add an object to the object registry. IceGrid will get the object type by calling `ice_id` on the given proxy. The object must be reachable.

Parameters

`obj`

The object to be added to the registry.

Exceptions

`ObjectExistsException`

Raised if the object is already registered.

`DeploymentException`

Raised if the object can't be added. This might be raised if the invocation on the proxy to get the object type failed.

updateObject

void updateObject(Object* obj) throws
ObjectNotRegisteredException, DeploymentException;

Update an object in the object registry. Only objects added with this interface can be updated with this operation. Objects added with deployment descriptors should be updated with the deployment mechanism.

Parameters

obj

The object to be updated to the registry.

Exceptions

ObjectNotRegisteredException

Raised if the object isn't registered with the registry.

DeploymentException

Raised if the object can't be updated. This might happen if the object was added with a deployment descriptor.

addObjectWithType

void addObjectWithType(Object* obj, string type) throws
ObjectExistsException;

Add an object to the object registry and explicitly specify its type.

Parameters

obj

The object to be added to the registry.

type

The object type.

Exceptions

ObjectExistsException

Raised if the object is already registered.

removeObject

```
[ "ami" ] void removeObject(::Ice::Identity id) throws  
ObjectNotRegisteredException, DeploymentException;
```

Remove an object from the object registry. Only objects added with this interface can be removed with this operation. Objects added with deployment descriptors should be removed with the deployment mechanism.

Parameters

id

The identity of the object to be removed from the registry.

Exceptions

ObjectNotRegisteredException

Raised if the object isn't registered with the registry.

DeploymentException

Raised if the object can't be removed. This might happen if the object was added with a deployment descriptor.

getObjectInfo

```
ObjectInfo getObjectInfo(::Ice::Identity id) throws  
ObjectNotRegisteredException;
```

Get the object info for the object with the given identity.

Parameters

id

The identity of the object.

Return Value

The object info.

Exceptions

ObjectNotRegisteredException

Raised if the object isn't registered with the registry.

getObjectInfosByType

```
ObjectInfoSeq getObjectInfosByType(string type);
```

Get the object info of all the registered objects with the given type.

Parameters

type

The type of the object.

Return Value

The object infos.

getAllObjectInfos

```
ObjectInfoSeq getAllObjectInfos(string expr);
```

Get the object info of all the registered objects whose stringified identities match the given expression.

Parameters

expr

The expression to match against the stringified identities of registered objects.
The expression may contain a trailing wildcard (*) character.

Return Value

All the object infos with a stringified identity matching the given expression.

pingNode

```
bool pingNode(string name) throws NodeNotExistException;
```

Ping an IceGrid node to see if it is active.

Parameters

name

The node name.

Return Value

true if the node ping succeeded, false otherwise.

Exceptions

`NodeNotExistException`

Raised if the node doesn't exist.

getNodeLoad

```
[ "ami" ] LoadInfo getNodeLoad(string name) throws  
NodeNotExistException, NodeUnreachableException;
```

Get the load averages of the node.

Parameters

name

The node name.

Return Value

The node load information.

Exceptions

`NodeNotExistException`

Raised if the node doesn't exist.

`NodeUnreachableException`

Raised if the node could not be reached.

getNodeInfo

```
NodeInfo getNodeInfo(string name) throws NodeNotExistException,  
NodeUnreachableException;
```

Get the node information for the node with the given name.

Parameters

name

The node name.

Return Value

The node information.

Exceptions

`NodeNotExistException`

 Raised if the node doesn't exist.

`NodeUnreachableException`

 Raised if the node could not be reached.

shutdownNode

```
[ "ami" ] void shutdownNode(string name) throws  
NodeNotExistException, NodeUnreachableException;
```

Shutdown an IceGrid node.

Parameters

name

 The node name.

Exceptions

`NodeNotExistException`

 Raised if the node doesn't exist.

`NodeUnreachableException`

 Raised if the node could not be reached.

getNodeHostname

```
string getNodeHostname(string name) throws NodeNotExistException,  
NodeUnreachableException;
```

Get the hostname of this node.

Parameters

name

 The node name.

Return Value

The node hostname.

Exceptions

`NodeNotExistException`

Raised if the node doesn't exist.

`NodeUnreachableException`

Raised if the node could not be reached.

getAllNodeNames

```
::Ice::StringSeq getAllNodeNames();
```

Get all the IceGrid nodes currently registered.

Return Value

The node names.

shutdown

```
void shutdown();
```

Shut down the IceGrid registry.

getSliceChecksums

```
::Ice::SliceChecksumDict getSliceChecksums();
```

Returns the checksums for the IceGrid Slice definitions.

Return Value

A dictionary mapping Slice type ids to their checksums.

B.127 IceGrid::AdminSession

Overview

```
interface AdminSession extends ::Glacier2::Session
```

An admin session object used by administrative clients to view, update and receive observer updates from the IceGrid registry. Admin sessions are created either with the Registry object or the registry admin `::Glacier2::SessionManager` object.

See Also

Registry, `::Glacier2::SessionManager`.

keepAlive

```
void keepAlive();
```

Keep the session alive. Clients should call this operation regularly to prevent the server from reaping the session.

See Also

Registry::getSessionTimeout.

getAdmin

```
Admin* getAdmin();
```

Get the admin interface. The admin object returned by this operation can only be accessed by the session.

Return Value

The admin interface proxy.

setObservers

```
void setObservers(RegistryObserver* registryObs, NodeObserver* nodeObs);
```

Set the proxies of the observer objects that will receive notifications from the servers when the state of the registry or nodes changes.

Parameters

registryObs

The registry observer.

nodeObs

The node observer.

setObserversByIdentity

```
void setObserversByIdentity(::Ice::Identity registryObs,  
::Ice::Identity nodeObs);
```

Set the identities of the observer objects that will receive notifications from the servers when the state of the registry or nodes changes. This operation should be used by clients that are using a bidirectional connection to communicate with the session.

Parameters

registryObs

The registry observer identity.

nodeObs

The node observer identity.

startUpdate

```
int startUpdate() throws AccessDeniedException;
```

Acquires an exclusive lock to start updating the registry applications.

Return Value

The current serial.

Exceptions

`AccessDeniedException`

Raised if the exclusive lock can't be acquired. This might happen if the lock is currently acquired by another session.

`finishUpdate`

`void finishUpdate() throws AccessDeniedException;`

Finish updating the registry and release the exclusive lock.

Exceptions

`AccessDeniedException`

Raised if the session doesn't hold the exclusive lock.

B.128 `IceGrid::AllocationException`

Overview

exception `AllocationException`

This exception is raised if the allocation of an object failed.

Derived Exceptions

`AllocationTimeoutException`.

Used By

`Session::allocateObjectById`, `Session::allocateObjectByType`,
`Session::releaseObject`.

`reason`

`string reason;`

The reason why the object couldn't be allocated.

B.129 IceGrid::AllocationTimeoutException

Overview

exception AllocationTimeoutException extends AllocationException

This exception is raised if the request to allocate an object times out.

B.130 IceGrid::ApplicationDescriptor

Overview

struct ApplicationDescriptor

An application descriptor.

Used By

Admin::addApplication, Admin::getApplicationDescriptor,
Admin::syncApplication, ApplicationDescriptorSeq, FileParser::parse,
RegistryObserver::applicationAdded, Admin::getDefaultApplicationDe-
scriptor.

name

string name;

The application name.

variables

["java:type:{java.util.TreeMap}"] StringStringDict variables;

The variables defined in the application descriptor.

replicaGroups

ReplicaGroupDescriptorSeq replicaGroups;

The replica groups.

`serverTemplates`

`TemplateDescriptorDict serverTemplates;`

The server templates.

`serviceTemplates`

`TemplateDescriptorDict serviceTemplates;`

The service templates.

`nodes`

`NodeDescriptorDict nodes;`

The application nodes.

`distrib`

`DistributionDescriptor distrib;`

The application distribution.

`description`

`string description;`

The description of this application.

`propertySets`

`PropertySetDescriptorDict propertySets;`

Property set descriptors.

B.131 `IceGrid::ApplicationNotExistException`

Overview

exception `ApplicationNotExistException`

This exception is raised if an application does not exist.

Used By

`Admin::getApplicationDescriptor`, `Admin::instantiateServer`,
`Admin::patchApplication`, `Admin::removeApplication`, `Admin::syncApplication`,
`Admin::updateApplication`.

name

string name;

B.132 `IceGrid::ApplicationUpdateDescriptor`

Overview

struct `ApplicationUpdateDescriptor`

An application update descriptor to describe the updates to apply to a deployed application.

Used By

`Admin::updateApplication`, `RegistryObserver::applicationUpdated`.

name

string name;

The name of the application to update.

description

BoxedString description;

The updated description (or null if the description wasn't updated.)

distrib

BoxedDistributionDescriptor distrib;

The updated distribution application descriptor.

variables

["java:type:{java.util.TreeMap}"] StringStringDict variables;

The variables to update.

removeVariables

::Ice::StringSeq removeVariables;

The variables to remove.

propertySets

PropertySetDescriptorDict propertySets;

The property sets to update.

removePropertySets

::Ice::StringSeq removePropertySets;

The property sets to remove.

replicaGroups

ReplicaGroupDescriptorSeq replicaGroups;

The replica groups to update.

removeReplicaGroups

```
::Ice::StringSeq removeReplicaGroups;
```

The replica groups to remove.

serverTemplates

```
TemplateDescriptorDict serverTemplates;
```

The server templates to update.

removeServerTemplates

```
::Ice::StringSeq removeServerTemplates;
```

The ids of the server template to remove.

serviceTemplates

```
TemplateDescriptorDict serviceTemplates;
```

The service templates to update.

removeServiceTemplates

```
::Ice::StringSeq removeServiceTemplates;
```

The ids of the service template to remove.

nodes

```
NodeUpdateDescriptorSeq nodes;
```

The application nodes to update.

removeNodes

```
::Ice::StringSeq removeNodes;
```

The nodes to remove.

B.133 `IceGrid::BadSignalException`

Overview

exception `BadSignalException`

This exception is raised if an unknown signal was sent to a server.

Used By

`Admin::sendSignal`.

reason

string reason;

B.134 `IceGrid::BoxedDistributionDescriptor`

Overview

class `BoxedDistributionDescriptor`

A "boxed" distribution descriptor.

Used By

`ApplicationUpdateDescriptor::distrib`.

value

`DistributionDescriptor` value;

The value of the boxed distribution descriptor.

B.135 IceGrid::BoxedString

Overview

class BoxedString

A "boxed" string.

Used By

ApplicationUpdateDescriptor::description, NodeUpdateDescriptor::description, NodeUpdateDescriptor::loadFactor.

value

string value;

The value of the boxed string.

B.136 IceGrid::CommunicatorDescriptor

Overview

class CommunicatorDescriptor

A communicator descriptor.

Derived Classes and Interfaces

ServerDescriptor, ServiceDescriptor.

Used By

TemplateDescriptor::descriptor.

adapters

AdapterDescriptorSeq adapters;

The object adapters.

propertySet

PropertySetDescriptor propertySet;

The property set.

dbEnvs

DbEnvDescriptorSeq dbEnvs;

The database environments.

description

string description;

A description of this descriptor.

B.137 IceGrid::DbEnvDescriptor

Overview

struct DbEnvDescriptor

A Freeze database environment descriptor.

Used By

DbEnvDescriptorSeq.

name

string name;

The name of the database environment.

description

string description;

The description of this database environment.

dbHome

```
string dbHome;
```

The home of the database environment (i.e., the directory where the database files will be stored). If empty, the node will provide a default database directory, otherwise the directory must exist.

properties

```
PropertyDescriptorSeq properties;
```

The configuration properties of the database environment.

B.138 IceGrid::DeploymentException

Overview

exception DeploymentException

An exception for deployment failure errors.

Used By

Admin::addApplication, Admin::addObject, Admin::enableServer, Admin::getDefaultApplicationDescriptor, Admin::getServerPid, Admin::getServerState, Admin::instantiateServer, Admin::isServerEnabled, Admin::patchServer, Admin::removeAdapter, Admin::removeObject, Admin::sendSignal, Admin::startServer, Admin::stopServer, Admin::syncApplication, Admin::updateApplication, Admin::updateObject, Admin::writeMessage.

reason

```
string reason;
```

The reason for the failure.

B.139 IceGrid::DistributionDescriptor

Overview

```
struct DistributionDescriptor
```

A distribution descriptor defines an IcePatch2 server and the directories to retrieve from the patch server.

Used By

ApplicationDescriptor::distrib, BoxedDistributionDescriptor::value, ServerDescriptor::distrib.

icepatch

```
string icepatch;
```

The proxy of the IcePatch2 server.

directories

```
[ "java:type:{java.util.LinkedList}" ] ::Ice::StringSeq  
directories;
```

The source directories.

B.140 IceGrid::FileParser

Overview

```
interface FileParser
```

The icegridadmin command line tool provides a FileParser object to transform XML files into ApplicationDescriptor objects (structs).

parse

```
ApplicationDescriptor parse(string xmlFile, Admin* adminProxy)
throws ParseException;
```

Parse a file.

Parameters

xmlFile

Full pathname to the file.

adminProxy

An Admin proxy, used only to retrieve default templates when needed. May be null.

Return Value

s The application descriptor.

Exceptions

ParseException

Raised if an error occurred during parsing.

B.141 IceGrid::IceBoxDescriptor

Overview

```
class IceBoxDescriptor extends ServerDescriptor
```

An IceBox server descriptor.

services

```
ServiceInstanceDescriptorSeq services;
```

The service instances.

B.142 IceGrid::LoadBalancingPolicy

Overview

class LoadBalancingPolicy

A base class for load balancing policies.

Derived Classes and Interfaces

AdaptiveLoadBalancingPolicy, RandomLoadBalancingPolicy, RoundRobinLoadBalancingPolicy.

Used By

ReplicaGroupDescriptor::loadBalancing.

nReplicas

string nReplicas;

The number of replicas that will be used to gather the endpoints of a replica group.

B.143 IceGrid::LoadInfo

Overview

struct LoadInfo

Information about the load of a node.

Used By

Admin::getNodeLoad.

avg1

float avg1;

The load average over the past minute.

avg5

float avg5;

The load average over the past 5 minutes.

avg15

float avg15;

The load average over the past 15 minutes.

B.144 IceGrid::LoadSample

Overview

enum LoadSample

Determines which load sampling interval to use.

Used By

Query::findObjectByTypeOnLeastLoadedNode.

LoadSample1

LoadSample1

LoadSample5

LoadSample5

LoadSample15

LoadSample15

B.145 IceGrid::NodeDescriptor

Overview

```
struct NodeDescriptor
```

A node descriptor.

Used By

NodeDescriptorDict.

variables

```
[ "java:type:{java.util.TreeMap}" ] StringStringDict variables;
```

The variables defined for the node.

serverInstances

```
ServerInstanceDescriptorSeq serverInstances;
```

The server instances.

servers

```
ServerDescriptorSeq servers;
```

Servers (which are not template instances).

loadFactor

```
string loadFactor;
```

Load factor of the node.

description

```
string description;
```

The description of this node.

propertySets

PropertySetDescriptorDict propertySets;

Property set descriptors.

B.146 IceGrid::NodeDynamicInfo

Overview

struct NodeDynamicInfo

Dynamic information about the state of a node.

Used By

NodeDynamicInfoSeq, NodeObserver::nodeUp.

name

string name;

The name of the node.

info

NodeInfo info;

Some static information about the node.

servers

ServerDynamicInfoSeq servers;

The dynamic information of the servers deployed on this node.

adapters

AdapterDynamicInfoSeq adapters;

The dynamic information of the adapters deployed on this node.

B.147 IceGrid::NodeInfo

Overview

```
struct NodeInfo
```

Information about an IceGrid node.

Used By

Admin::getNodeInfo, NodeDynamicInfo::info.

os

```
string os;
```

The operating system name.

hostname

```
string hostname;
```

The network name of the host running this node (as defined in `uname()`).

release

```
string release;
```

The operation system release level (as defined in `uname()`).

version

```
string version;
```

The operation system version (as defined in `uname()`).

machine

```
string machine;
```

The machine hardware type (as defined in `uname()`).

nProcessors

```
int nProcessors;
```

The number of processors.

dataDir

```
string dataDir;
```

The path to the node data directory.

B.148 IceGrid::NodeNotExistException

Overview

exception NodeNotExistException

This exception is raised if a node does not exist.

Used By

Admin::getNodeHostname, Admin::getNodeInfo, Admin::getNodeLoad,
Admin::pingNode, Admin::shutdownNode.

name

```
string name;
```

B.149 IceGrid::NodeObserver

Overview

interface NodeObserver

The node observer interface. Observers should implement this interface to receive information about the state of the IceGrid nodes.

init

```
[ "ami" ] void init(NodeDynamicInfoSeq nodes);
```

The init operation is called after the registration of the observer to communicate the current state of the node to the observer implementation.

Parameters

nodes

The current state of the nodes.

nodeUp

```
void nodeUp(NodeDynamicInfo node);
```

The nodeUp operation is called to notify the observer that a node came up.

Parameters

node

The node state.

nodeDown

```
void nodeDown(string name);
```

The nodeDown operation is called to notify the observer that a node went down.

Parameters

name

The node name.

updateServer

```
void updateServer(string node, ServerDynamicInfo updatedInfo);
```

The updateServer operation is called to notify the observer that the state of a server changed.

Parameters

node

The node hosting the server.

updatedInfo

The new server state.

updateAdapter

```
void updateAdapter(string node, AdapterDynamicInfo updatedInfo);
```

The updateAdapter operation is called to notify the observer that the state of an adapter changed.

Parameters

node

The node hosting the adapter.

updatedInfo

The new adapter state.

B.150 `IceGrid::NodeUnreachableException`

Overview

exception `NodeUnreachableException`

This exception is raised if a node could not be reached.

Used By

`Admin::enableServer`, `Admin::getNodeHostname`, `Admin::getNodeInfo`,
`Admin::getNodeLoad`, `Admin::getServerPid`, `Admin::getServerState`,
`Admin::isServerEnabled`, `Admin::patchServer`, `Admin::sendSignal`,
`Admin::shutdownNode`, `Admin::startServer`, `Admin::stopServer`,
`Admin::writeMessage`.

name

string name;

The name of the node that is not reachable.

reason

string reason;

The reason why the node couldn't be reached.

B.151 `IceGrid::NodeUpdateDescriptor`

Overview

struct NodeUpdateDescriptor

A node update descriptor to describe the updates to apply to a node of a deployed application.

Used By

NodeUpdateDescriptorSeq.

name

string name;

The name of the node to update.

description

BoxedString description;

The updated description (or null if the description wasn't updated.)

variables

["java:type:{java.util.TreeMap}"] StringStringDict variables;

The variables to update.

removeVariables

```
::Ice::StringSeq removeVariables;
```

The variables to remove.

propertySets

```
PropertySetDescriptorDict propertySets;
```

The property sets to update.

removePropertySets

```
::Ice::StringSeq removePropertySets;
```

The property sets to remove.

serverInstances

```
ServerInstanceDescriptorSeq serverInstances;
```

The server instances to update.

servers

```
ServerDescriptorSeq servers;
```

The servers which are not template instances to update.

removeServers

```
::Ice::StringSeq removeServers;
```

The ids of the servers to remove.

loadFactor

```
BoxedString loadFactor;
```

The updated load factor of the node (or null if the load factor wasn't updated.)

B.152 `IceGrid::ObjectDescriptor`

Overview

```
struct ObjectDescriptor
```

An Ice object descriptor.

Used By

`ObjectDescriptorSeq`.

`id`

```
::Ice::Identity id;
```

The identity of the object.

`type`

```
string type;
```

The object type.

B.153 `IceGrid::ObjectExistsException`

Overview

```
exception ObjectExistsException
```

This exception is raised if an object already exists.

Used By

`Admin::addObject`, `Admin::addObjectWithType`.

```
id
::Ice::Identity id;
```

B.154 IceGrid::ObjectInfo

Overview

```
struct ObjectInfo
```

Information about an Ice object.

Used By

Admin::getObjectInfo, ObjectInfoSeq, RegistryObserver::objectAdded,
RegistryObserver::objectUpdated.

proxy

```
Object* proxy;
```

The proxy of the object.

type

```
string type;
```

The type of the object.

B.155 IceGrid::ObjectNotRegisteredException

Overview

```
exception ObjectNotRegisteredException
```

This exception is raised if an object is not registered.

Used By

Admin::getObjectInfo, Admin::removeObject, Admin::updateObject,
Session::allocateObjectById, Session::releaseObject.

id

::Ice::Identity id;

B.156 IceGrid::ParseException

Overview

exception ParseException

This exception is raised if an error occurs during parsing.

Used By

FileParser::parse.

reason

string reason;

The reason for the failure.

B.157 IceGrid::PatchException

Overview

exception PatchException

This exception is raised if a patch failed.

Used By

Admin::patchApplication, Admin::patchServer.

reasons

```
::Ice::StringSeq reasons;
```

The reasons why the patch failed.

B.158 IceGrid::PermissionDeniedException

Overview

exception PermissionDeniedException

This exception is raised if a client is denied the ability to create a session with IceGrid.

Used By

Registry::createAdminSession, Registry::createAdminSessionFromSecureConnection, Registry::createSession, Registry::createSessionFromSecureConnection.

See Also

SessionFactory::createSession.

reason

```
string reason;
```

The reason why permission was denied.

B.159 `IceGrid::PropertyDescriptor`

Overview

```
struct PropertyDescriptor
```

Property descriptor.

Used By

`PropertyDescriptorSeq`.

`name`

```
string name;
```

`value`

```
string value;
```

B.160 `IceGrid::PropertySetDescriptor`

Overview

```
struct PropertySetDescriptor
```

A property set descriptor.

Used By

`CommunicatorDescriptor::propertySet`, `PropertySetDescriptorDict`,
`ServerInstanceDescriptor::propertySet`, `ServiceInstanceDe-
scriptor::propertySet`.

references

`::Ice::StringSeq references;`

References to named property sets.

properties

`PropertyDescriptorSeq properties;`

The property set properties.

B.161 `IceGrid::Query`

Overview

`["ami", "amd"] interface Query`

The IceGrid query interface. This interface is accessible to Ice clients who wish to lookup well-known objects.

`findObjectById`

`Object* findObjectById(::Ice::Identity id);`

Find a well-known object by identity.

Parameters

`id`

The identity.

Return Value

The proxy or null if no such object has been found.

`findObjectByType`

`Object* findObjectByType(string type);`

Find a well-known object by type. If there are several objects registered for the given type, the object will be randomly selected.

Parameters

type

The object type.

Return Value

The proxy or null if no such object has been found.

findObjectByTypeOnLeastLoadedNode

```
Object* findObjectByTypeOnLeastLoadedNode(string type, LoadSample sample);
```

Find a well-known object by type on the least loaded node. If the registry can't figure out the node that hosts the object (e.g., if the object was registered with a direct proxy), the registry assumes the object is hosted on a node that has a load average of 1.0.

Parameters

type

The object type.

Return Value

The proxy or null if no such object has been found.

findAllObjectsByType

```
::Ice::ObjectProxySeq findAllObjectsByType(string type);
```

Find all the well-known objects with the given type.

Parameters

type

The object type.

Return Value

The proxies or an empty sequence if no such objects have been found.

B.162 `IceGrid::RandomLoadBalancingPolicy`

Overview

`class RandomLoadBalancingPolicy extends LoadBalancingPolicy`

Random load balancing policy.

B.163 `IceGrid::Registry`

Overview

`interface Registry`

The IceGrid registry provides a registry object to allow clients or administrative clients to create sessions directly with the registry.

See Also

`Session`, `AdminSession`.

createSession

`Session* createSession(string userId, string password) throws PermissionDeniedException;`

Create a client session.

Parameters

`userId`

The user id.

`password`

The password for the given user id.

Return Value

A proxy for the newly created session.

Exceptions

`PermissionDeniedException`

Raised if the password for the given user id is not correct, or if the user is not allowed access.

See Also

`Session, ::Glacier2::PermissionsVerifier.`

createAdminSession

```
AdminSession* createAdminSession(string userId, string password)  
throws PermissionDeniedException;
```

Create an administrative session.

Parameters

`userId`

The user id.

`password`

The password for the given user id.

Return Value

A proxy for the newly created session.

Exceptions

`PermissionDeniedException`

Raised if the password for the given user id is not correct, or if the user is not allowed access.

See Also

`Session, ::Glacier2::PermissionsVerifier.`

createSessionFromSecureConnection

Session* createSessionFromSecureConnection() throws
PermissionDeniedException;

Create a client session from a secure connection.

Parameters

userId

The user id.

password

The password for the given user id.

Return Value

A proxy for the newly created session.

Exceptions

PermissionDeniedException

Raised if the password for the given user id is not correct, or if the user is not allowed access.

See Also

Session, ::Glacier2::SSLPermissionsVerifier.

createAdminSessionFromSecureConnection

AdminSession* createAdminSessionFromSecureConnection() throws
PermissionDeniedException;

Create an administrative session from a secure connection.

Return Value

A proxy for the newly created session.

Exceptions

PermissionDeniedException

Raised if the password for the given user id is not correct, or if the user is not allowed access.

See Also

Session, ::Glacier2::SSLPermissionsVerifier.

getSessionTimeout

```
int getSessionTimeout();
```

Get the session timeout. If a client or administrative client doesn't call the session `keepAlive` method in the time interval defined by this timeout, IceGrid might reap the session.

Return Value

The timeout in milliseconds.

See Also

Session::keepAlive, AdminSession::keepAlive.

B.164 IceGrid::RegistryObserver

Overview

```
interface RegistryObserver
```

The registry observer interface. Observers should implement this interface to receive information about the state of the IceGrid registry.

init

```
[ "ami" ] void init(int serial, ApplicationDescriptorSeq  
applications, AdapterInfoSeq adpts, ObjectInfoSeq objects);
```

The `init` operation is called after the registration of the observer to communicate the current state of the registry to the observer implementation.

Parameters

`serial`

The current serial number of the registry database. This serial number allows observers to make sure that their internal state is synchronized with the registry.

`applications`

The applications currently registered with the registry.

`adapters`

The adapters that were dynamically registered with the registry (not through the deployment mechanism).

`objects`

The objects registered with the Admin interface (not through the deployment mechanism).

applicationAdded

```
void applicationAdded(int serial, ApplicationDescriptor desc);
```

The `applicationAdded` operation is called to notify the observer that an application was added.

Parameters

`serial`

The new serial number of the registry database.

`desc`

The descriptor of the new application.

applicationRemoved

```
void applicationRemoved(int serial, string name);
```

The `applicationRemoved` operation is called to notify the observer that an application was removed.

Parameters

`serial`

The new serial number of the registry database.

`name`

The name of the application that was removed.

applicationUpdated

```
void applicationUpdated(int serial, ApplicationUpdateDescriptor desc);
```

The `applicationUpdated` operation is called to notify the observer that an application was updated.

Parameters

`serial`

The new serial number of the registry database.

`desc`

The descriptor of the update.

adapterAdded

```
void adapterAdded(int serial, AdapterInfo info);
```

The `adapterAdded` operation is called to notify the observer when a dynamically-registered adapter was added.

adapterUpdated

```
void adapterUpdated(int serial, AdapterInfo info);
```

The `adapterUpdated` operation is called to notify the observer when a dynamically-registered adapter was updated.

adapterRemoved

```
void adapterRemoved(int serial, string id);
```

The `adapterRemoved` operation is called to notify the observer when a dynamically-registered adapter was removed.

`objectAdded`

```
void objectAdded(int serial, ObjectInfo info);
```

The `objectAdded` operation is called to notify the observer when an object was added through the `Admin` interface.

`objectUpdated`

```
void objectUpdated(int serial, ObjectInfo info);
```

The `objectUpdated` operation is called to notify the observer when an object registered through the `Admin` interface was updated.

`objectRemoved`

```
void objectRemoved(int serial, ::Ice::Identity id);
```

The `objectRemoved` operation is called to notify the observer when an object registered through the `Admin` interface was removed.

B.165 `IceGrid::ReplicaGroupDescriptor`

Overview

```
struct ReplicaGroupDescriptor
```

A replica group descriptor.

Used By

`ReplicaGroupDescriptorSeq`.

`id`

```
string id;
```

The id of the replica group.

loadBalancing

```
LoadBalancingPolicy loadBalancing;
```

The load balancing policy.

objects

```
ObjectDescriptorSeq objects;
```

The object descriptors associated with this object adapter.

description

```
string description;
```

The description of this replica group.

B.166 `IceGrid::RoundRobinLoadBalancingPolicy`

Overview

```
class RoundRobinLoadBalancingPolicy extends LoadBalancingPolicy
```

Round robin load balancing policy.

B.167 `IceGrid::ServerDescriptor`

Overview

```
class ServerDescriptor extends CommunicatorDescriptor
```

An Ice server descriptor.

Derived Classes and Interfaces

IceBoxDescriptor.

Used By

ServerDescriptorSeq, ServerInfo::descriptor.

id

string id;

The server id.

exe

string exe;

The path of the server executable.

pwd

string pwd;

The path to the server working directory.

options

```
[ "java:type:{java.util.LinkedList}" ] ::Ice::StringSeq options;
```

The command line options to pass to the server executable.

envs

```
[ "java:type:{java.util.LinkedList}" ] ::Ice::StringSeq envs;
```

The server environment variables.

activation

string activation;

The server activation mode (possible values are "on-demand" or "manual").

`activationTimeout`

```
string activationTimeout;
```

The activation timeout (an integer value representing the number of seconds to wait for activation).

`deactivationTimeout`

```
string deactivationTimeout;
```

The deactivation timeout (an integer value representing the number of seconds to wait for deactivation).

`applicationDistrib`

```
bool applicationDistrib;
```

Specifies if the server depends on the application distribution.

`distrib`

```
DistributionDescriptor distrib;
```

The distribution descriptor.

`allocatable`

```
bool allocatable;
```

Specifies if the server is allocatable.

`user`

```
string user;
```

The user account used to run the server.

B.168 `IceGrid::ServerDynamicInfo`

Overview

```
struct ServerDynamicInfo
```

Dynamic information about the state of a server.

Used By

```
NodeObserver::updateServer, ServerDynamicInfoSeq.
```

id

```
string id;
```

The id of the server.

state

```
ServerState state;
```

The state of the server.

pid

```
int pid;
```

The process id of the server.

enabled

```
bool enabled;
```

Indicates whether the server is enabled.

B.169 IceGrid::ServerInfo

Overview

```
struct ServerInfo
```

Information about a server managed by an IceGrid node.

Used By

Admin::getServerInfo.

application

```
string application;
```

The server application.

node

```
string node;
```

The server node.

descriptor

```
ServerDescriptor descriptor;
```

The server descriptor.

B.170 IceGrid::ServerInstanceDescriptor

Overview

```
struct ServerInstanceDescriptor
```

A server template instance descriptor.

Used By

Admin::instantiateServer, ServerInstanceDescriptorSeq.

template

string template;

The template used by this instance.

parameterValues

StringStringDict parameterValues;

The template parameter values.

propertySet

PropertySetDescriptor propertySet;

The property set.

B.171 IceGrid::ServerNotExistException

Overview

exception ServerNotExistException

This exception is raised if a server does not exist.

Used By

Admin::enableServer, Admin::getServerInfo, Admin::getServerPid,
Admin::getServerState, Admin::isServerEnabled, Admin::patchServer,
Admin::sendSignal, Admin::startServer, Admin::stopServer,
Admin::writeMessage.

id

string id;

The identifier of the server.

B.172 `IceGrid::ServerStartException`

Overview

exception `ServerStartException`

This exception is raised if a server failed to start.

Used By

`Admin::startServer`.

`id`

string `id`;

The identifier of the server.

`reason`

string `reason`;

The reason for the failure.

B.173 `IceGrid::ServerState`

Overview

enum `ServerState`

An enumeration representing the state of the server.

Used By

`Admin::getServerState`, `ServerDynamicInfo::state`.

Inactive

Inactive

The server is not running.

Activating

Activating

The server is being activated and will change to the active state when the registered server object adapters are activated.

Active

Active

The server is running.

Deactivating

Deactivating

The server is being deactivated.

Destroying

Destroying

The server is being destroyed.

Destroyed

Destroyed

The server is destroyed.

B.174 IceGrid::ServerStopException

Overview

exception ServerStopException

This exception is raised if a server failed to stop.

Used By

Admin::stopServer.

id

string id;

The identifier of the server.

reason

string reason;

The reason for the failure.

B.175 IceGrid::ServiceDescriptor

Overview

class ServiceDescriptor extends CommunicatorDescriptor

An IceBox service descriptor.

Used By

ServiceDescriptorSeq, ServiceInstanceDescriptor::descriptor.

name

string name;

The service name.

`entry`

`string entry;`

The entry point of the IceBox service.

B.176 `IceGrid::ServiceInstanceDescriptor`

Overview

`struct ServiceInstanceDescriptor`

A service template instance descriptor.

Used By

`ServiceInstanceDescriptorSeq`.

`template`

`string template;`

The template used by this instance.

`parameterValues`

`StringStringDict parameterValues;`

The template parameter values.

`descriptor`

`ServiceDescriptor descriptor;`

The service definition if the instance isn't a template instance (i.e.: if the template attribute is empty).

propertySet

```
PropertySetDescriptor propertySet;
```

The property set.

B.177 IceGrid::Session

Overview

```
interface Session extends ::Glacier2::Session
```

A session object is used by IceGrid clients to allocate and release objects. Client sessions are either created with the Registry object or the registry client `::Glacier2::SessionManager` object.

See Also

Registry, `::Glacier2::SessionManager`.

keepAlive

```
void keepAlive();
```

Keep the session alive. Clients should call this operation regularly to prevent the server from reaping the session.

See Also

Registry::getSessionTimeout.

allocateObjectById

```
[ "ami", "amd" ] Object* allocateObjectById(::Ice::Identity id)  
throws ObjectNotRegisteredException, AllocationException;
```

Allocate an object. Depending on the allocation timeout, this operation might hang until the object is available or until the timeout is reached.

Parameters

id

The identity of the object to allocate.

Return Value

The proxy of the allocated object.

Exceptions

`ObjectNotRegisteredException`

Raised if the object with the given identity is not registered with the registry.

`AllocationException`

Raised if the object can't be allocated.

See Also

`setAllocationTimeout`, `releaseObject`.

allocateObjectByType

```
[ "ami", "amd" ] Object* allocateObjectByType(string type) throws AllocationException;
```

Allocate an object with the given type. Depending on the allocation timeout, this operation might hang until an object becomes available or until the timeout is reached.

Parameters

type

The type of the object.

Return Value

The proxy of the allocated object.

Exceptions

Raised

if no objects with the given type can be allocated.

See Also

setAllocationTimeout, releaseObject.

releaseObject

```
void releaseObject(::Ice::Identity id) throws  
ObjectNotRegisteredException, AllocationException;
```

Release an object.

Parameters

id

The identity of the object to release.

Exceptions

ObjectNotRegisteredException

Raised if the object with the given identity is not registered with the registry.

AllocationException

Raised if the given object can't be released. This might happen if the object isn't allocatable or isn't allocated by the session.

See Also

allocateObjectById, allocateObjectByType.

setAllocationTimeout

```
void setAllocationTimeout(int timeout);
```

Set the allocation timeout. If no objects are available for an allocation request, the request will hang for the duration of this timeout.

Parameters

timeout

The timeout in milliseconds.

See Also

allocateObjectById, allocateObjectByType.

B.178 IceGrid::TemplateDescriptor

Overview

```
struct TemplateDescriptor
```

A template descriptor for server or service templates.

Used By

TemplateDescriptorDict.

descriptor

```
CommunicatorDescriptor descriptor;
```

The template.

parameters

```
[ "java:type:{java.util.LinkedList}" ] ::Ice::StringSeq  
parameters;
```

The parameters required to instantiate the template.

parameterDefaults

```
StringStringDict parameterDefaults;
```

The parameters default values.

B.179 IceGrid::UserAccountMapper

Overview

```
interface UserAccountMapper
```

A user account mapper object is used by IceGrid nodes to map session identifiers to user accounts.

getUserAccount

`string getUserAccount(string user)` throws `UserAccountNotFoundException`;

Get the name of the user account for the given user. This is used by IceGrid nodes to figure out the user account to use to run servers.

Parameters

`user`

The value of the server descriptor's `user` attribute. If this attribute is not defined, and the server's activation mode is `session`, the default value of `getUserAccount` is the session identifier.

Return Value

The user account name.

Exceptions

`UserAccountNotFoundException`

Raised if no user account is found for the given user.

B.180 `IceGrid::UserAccountNotFoundException`

Overview

exception `UserAccountNotFoundException`

This exception is raised if a user account for a given session identifier can't be found.

Used By

`UserAccountMapper::getUserAccount`.

B.181 IceStorm

Overview

module IceStorm

A messaging service with support for federation. In contrast to most other messaging or event services, IceStorm supports typed events, meaning that broadcasting a message over a federation is as easy as invoking a method on an interface.

LinkInfoSeq

sequence<LinkInfo> LinkInfoSeq;

A sequence of LinkInfo objects.

Used By

Topic::getLinkInfoSeq.

QoS

dictionary<string, string> QoS;

This dictionary represents Quality of service parameters.

Used By

Topic::subscribe.

See Also

Topic::subscribe.

TopicDict

dictionary<string, Topic*> TopicDict;

Mapping of topic name to topic proxy.

Used By

TopicManager::retrieveAll.

B.182 IceStorm::LinkExists

Overview

exception LinkExists

This exception indicates that an attempt was made to create a link that already exists.

Used By

Topic::link.

name

string name;

The name of the linked topic.

B.183 IceStorm::LinkInfo

Overview

struct LinkInfo

Information on the topic links.

Used By

LinkInfoSeq.

theTopic

Topic* theTopic;

The linked topic.

name

string name;

The name of the linked topic.

cost

int cost;

The cost of traversing this link.

B.184 `IceStorm::NoSuchLink`

Overview

exception `NoSuchLink`

This exception indicates that an attempt was made to remove a link that does not exist.

Used By

`Topic::unlink`.

name

string name;

The name of the link that does not exist.

B.185 `IceStorm::NoSuchTopic`

Overview

exception `NoSuchTopic`

This exception indicates that an attempt was made to retrieve a topic that does not exist.

Used By

TopicManager::retrieve.

name

string name;

The name of the topic that does not exist.

B.186 IceStorm::Topic

Overview

interface Topic

Publishers publish information on a particular topic. A topic logically represents a type.

See Also

TopicManager.

getName

string getName();

Get the name of this topic.

Return Value

The name of the topic.

See Also

TopicManager::create.

getPublisher

```
Object* getPublisher();
```

Get a proxy to a publisher object for this topic. To publish data to a topic, the publisher calls `getPublisher` and then casts to the topic type. An unchecked cast must be used on this proxy.

Return Value

A proxy to publish data on this topic.

subscribe

```
void subscribe(QoS theQoS, Object* subscriber);
```

Subscribe with the given QoS to this topic. If the given `subscribe` proxy has already been registered, it will be replaced.

Parameters

`qos`

The quality of service parameters for this subscription.

`subscriber`

The subscriber's proxy.

See Also

`unsubscribe`.

unsubscribe

```
void unsubscribe(Object* subscriber);
```

Unsubscribe the given `unsubscribe`.

Parameters

`subscriber`

The proxy of an existing subscriber.

See Also

`subscribe`.

link

`void link(Topic* linkTo, int cost) throws LinkExists;`

Create a link to the given topic. All events originating on this topic will also be sent to link.

Parameters

linkTo

The topic to link to.

cost

The cost to the linked topic.

Exceptions

LinkExists

Raised if a link to the same topic already exists.

unlink

`void unlink(Topic* linkTo) throws NoSuchLink;`

Destroy the link from this topic to the given topic unlink.

Parameters

link

The topic to destroy the link to.

Exceptions

NoSuchLink

Raised if a link to the topic does not exist.

getLinkInfoSeq

`LinkInfoSeq getLinkInfoSeq();`

Retrieve information on the current links.

Return Value

A sequence of LinkInfo objects.

destroy

```
void destroy();
```

Destroy the topic.

B.187 IceStorm::TopicExists

Overview

exception TopicExists

This exception indicates that an attempt was made to create a topic that already exists.

Used By

TopicManager::create.

name

```
string name;
```

The name of the topic that already exists.

B.188 IceStorm::TopicManager

Overview

interface TopicManager

A topic manager manages topics, and subscribers to topics.

See Also

Topic.

create

Topic* create(string name) throws TopicExists;

Create a new topic. The topic name must be unique, otherwise TopicExists is raised.

Parameters

name

The name of the topic.

Return Value

A proxy to the topic instance.

Exceptions

TopicExists

Raised if a topic with the same name already exists.

retrieve

Topic* retrieve(string name) throws NoSuchTopic;

Retrieve a topic by name.

Parameters

name

The name of the topic.

Return Value

A proxy to the topic instance.

Exceptions

NoSuchTopic

Raised if the topic does not exist.

retrieveAll

```
TopicDict retrieveAll();
```

Retrieve all topics managed by this topic manager.

Return Value

A dictionary of string, topic proxy pairs.

getSliceChecksums

```
::Ice::SliceChecksumDict getSliceChecksums();
```

Returns the checksums for the IceStorm Slice definitions.

Return Value

A dictionary mapping Slice type ids to their checksums.

B.189 IcePatch2

Overview

```
module IcePatch2
```

IcePatch2 can be used to update file hierarchies in a simple and efficient manner. Checksums ensure file integrity, and data is compressed before download.

ByteSeqSeq

```
sequence<::Ice::ByteSeq> ByteSeqSeq;
```

A sequence of byte sequences. Each element is the checksum for a partition.

Used By

```
FileServer::getChecksumSeq.
```

FileInfoSeq

```
sequence<FileInfo> FileInfoSeq;
```

A sequence with information about many files.

Used By

FileServer::getFileInfoSeq.

B.190 IcePatch2::Admin

Overview

interface Admin

The IcePatch2 administrative interface. This must only be accessible from inside the firewall.

shutdown

void shutdown();

Shut down the IcePatch2 server.

B.191 IcePatch2::FileAccessException

Overview

exception FileAccessException

This exception is raised if getFileCompressed cannot read the contents of a file.

Used By

FileServer::getFileCompressed.

reason

string reason;

An explanation of the reason for the failure.

B.192 IcePatch2::FileInfo

Overview

```
struct FileInfo
```

Basic information about a single file.

Used By

FileInfoSeq.

path

```
string path;
```

The pathname.

checksum

```
::Ice::ByteSeq checksum;
```

The SHA-1 checksum of the file.

size

```
int size;
```

The size of the compressed file in number of bytes.

executable

```
bool executable;
```

The executable flag.

B.193 IcePatch2::FileServer

Overview

interface FileServer

getFileInfoSeq

```
[ "ami" ] FileInfoSeq getFileInfoSeq(int partition) throws  
PartitionOutOfRangeException;
```

Return the FileInfoSeq for the specified partition. If the partition number is out of range, the operation throws PartitionOutOfRangeException.

Parameters

partition

The partition number in the range 0-255.

Return Value

A sequence containing the FileInfo structures for files in the specified partition.

getChecksumSeq

```
ByteSeqSeq getChecksumSeq();
```

Return the checksums for all partitions.

Return Value

A sequence containing 256 checksums. Partitions with a checksum that differs from the previous checksum for the same partition contain updated files. Partitions with a checksum that is identical to the previous checksum do not contain updated files.

getChecksum

```
::Ice::ByteSeq getChecksum();
```

Return the master checksum for all partitions. If this checksum is the same as for a previous run, the entire file set is up-to-date.

Return Value

The master checksum for the file set.

getFileCompressed

```
[ "ami", "amd", "cpp:array" ] ::Ice::ByteSeq  
getFileCompressed(string path, int pos, int num) throws  
FileAccessException;
```

Read the specified file. If the read operation fails, the operation throws `FileAccessException`. This operation may only return fewer bytes than requested in case there was an end-of-file condition.

Parameters

path

The pathname (relative to the data directory) for the file to be read.

pos

The file offset at which to begin reading.

num

The number of bytes to be read.

Return Value

A sequence containing the compressed file contents.

B.194 IcePatch2::PartitionOutOfRangeException

Overview

exception `PartitionOutOfRangeException`

This exception is raised if the `partition` argument for `getFileInfoSeq` is not in the range 0-255.

Used By

FileServer::getFileInfoSeq.

Appendix C

Properties

If not stated otherwise in the description of the individual properties, the default value for all properties is the empty string. If the property takes a numeric value, the empty string is interpreted as zero.

C.1 Ice Configuration Property

Ice.Config

Synopsis

```
--Ice.Config --Ice.Config=1 --Ice.Config=config_file
```

Description

This property must be set from the command line with the `--Ice.Config`, `--Ice.Config=1`, or `--Ice.Config=config_file` option.

If the `Ice.Config` property is empty or set to 1, the Ice run time examines the contents of the `ICE_CONFIG` environment variable to retrieve the path name of a configuration file. Otherwise, `Ice.Config` must be set to the path name of a configuration file. (Path Names can be relative or absolute.) Further property values are read from the configuration file thus specified.

Configuration File Syntax

A configuration file contains a number of property settings, one setting per line. Property settings have one of the forms

```
property_name= # Set property to the empty string or zero
```

```
property_name=value # Assign value to property
```

The # character indicates a comment: the # character and anything following the # character on the same line are ignored. A line that has the # character as its first non-white space character is ignored in its entirety.

A configuration file is free-form: blank, tab, and newline characters serve as token delimiters and are otherwise ignored.

Any setting of the `Ice.Config` property inside the configuration file itself is ignored.

C.2 Ice Trace Properties

Ice.Trace.GC

Synopsis

```
Ice.Trace.GC=num
```

Description

The garbage collector trace level:

0	No garbage collector trace (default).
1	Show the total number of instances collected, the total number of instances examined, the time spent in the collector in milliseconds, and the total number of runs of the collector.
2	Like 1, but also produces a trace message for each run of the collector.

Ice.Trace.Network

Synopsis

Ice.Trace.Network=*num*

Description

The network trace level:

0	No network trace (default).
1	Trace successful connection establishment and closure.
2	Like 1, but also traces attempts to bind, connect, and disconnect sockets.
3	Like 2, but also trace data transfer.

Ice.Trace.Location

Synopsis

Ice.Trace.Location=*num*

Description

The location trace level:

0	No location trace (default).
1	Trace Ice locator requests.
2	Like 1, but also trace the removal of endpoints from the cache.

Ice.Trace.Protocol

Synopsis

Ice.Trace.Protocol=*num*

Description

The protocol trace level:

0	No protocol trace (default).
1	Trace Ice protocol messages.

Ice.Trace.Retry**Synopsis**

`Ice.Trace.Retry=num`

Description

The request retry trace level:

0	No request retry trace (default).
1	Trace Ice operation call retries.
2	Also trace Ice endpoint usage.

Ice.Trace.Slicing**Synopsis**

`Ice.Trace.Slicing=num`

Description

The slicing trace level:

0	No trace of slicing activity (default).
1	Trace all exception and class types that are unknown to the receiver and therefore sliced.

C.3 Ice Warning Properties

Ice.Warn.Connections

Synopsis

Ice.Warn.Connections=*num*

Description

If *num* is set to a value larger than zero, Ice applications print warning messages for certain exceptional conditions in connections. The default value is 0.

Ice.Warn.Datagrams

Synopsis

Ice.Warn.Datagrams=*num*

Description

If *num* is set to a value larger than zero, servers print a warning message if they receive a datagram that exceeds the servers' receive buffer size. (Note that this condition is not detected by all UDP implementations -- some implementations silently drop received datagrams that are too large.) The default value is 0.

Ice.Warn.Dispatch

Synopsis

Ice.Warn.Dispatch=*num*

Description

If *num* is set to a value larger than zero, Ice applications print warning messages for certain exceptions that are raised while an incoming request is dispatched.

0	No warnings.
---	--------------

1	Print warnings for unexpected Ice::LocalException, Ice::UserException, C++ exceptions, and Java runtime exceptions (default).
2	Like 1, but also issue warnings for Ice::ObjectNotExistException, Ice::FacetNotExistException, and Ice::OperationNotExistException.

Ice.Warn.Endpoints

Synopsis

Ice.Warn.Endpoints=*num*

Description

If *num* is set to a value larger than zero, a warning is printed if a stringified proxy contains an endpoint that cannot be parsed. (For example, on versions of Ice that do not support SSL, stringified proxies containing SSL endpoints cause this warning.) The default value is 1.

Ice.Warn.AMICallback

Synopsis

Ice.Warn.AMICallback=*num*

Description

If *num* is set to a value larger than zero, warnings are printed if an AMI callback raises an exception. The default value is 1.

C.4 Ice Object Adapter Properties

adapter.AdapterId

Synopsis

adapter.AdapterId=id

Description

Specifies an identifier for the object adapter with the name *adapter*. This identifier must be unique among all object adapters using the same locator instance. If a locator proxy is defined using *adapter.Locator* or *Ice.Default.Locator*, this object adapter sets its endpoints with the locator registry upon activation.

adapter.ReplicaGroupId

Synopsis

adapter.ReplicaGroupId=id

Description

Identifies the group of replicated object adapters to which this adapter belongs. The replica group is treated as a virtual object adapter, so that an indirect proxy of the form *identity@id* refers to the object adapters in the group. During binding, a client will attempt to establish a connection to an endpoint of one of the participating object adapters, and automatically try others until a connection is successfully established or all attempts have failed. Similarly, an outstanding request will, when permitted, automatically fail over to another object adapter of the replica group upon connection failure. The set of endpoints actually used by the client during binding is determined by the locator's configuration policies.

Defining a value for this property has no effect unless *adapter.AdapterId* is also defined. Furthermore, the locator registry may require replica groups to be defined in advance (see *IceGrid.Registry.DynamicRegistration*), otherwise *Ice.NotRegisteredException* is raised upon adapter activation. Regardless of whether an object adapter is replicated, it can always be addressed individually in an indirect proxy if it defines a value for *adapter.AdapterId*.

adapter.Endpoints

Synopsis

adapter.Endpoints=endpoints

Description

Sets the endpoints for the object adapter *adapter* to *endpoints*. These endpoints specify the network interfaces on which the object adapter receives requests. Proxies created by the object adapter contain these endpoints, unless the *adapter.PublishedEndpoints* property is also specified.

adapter.PublishedEndpoints

Synopsis

adapter.PublishedEndpoints=endpoints

Description

When creating a proxy, the object adapter *adapter* normally includes the endpoints defined by *adapter.Endpoints*. If *adapter.PublishedEndpoints* is defined, the object adapter uses these endpoints instead. This is useful in many situations, such as when a server resides behind a port-forwarding firewall, in which case the object adapter's public endpoints must specify the address and port of the firewall.

adapter.Locator

Synopsis

adapter.Locator=locator

Description

Specifies a locator for the object adapter with the name *adapter*. The value is a stringified proxy to the Ice locator interface.

adapter.RegisterProcess

Synopsis

adapter.RegisterProcess=num

Description

If *num* is set to a value larger than zero, the object adapter with the name *name* registers the server with the locator registry. Registration occurs upon the object adapter's initial activation, during which the object adapter creates a servant implementing the `Ice::Process` interface, adds the servant using a UUID, and registers its proxy with the locator registry using the value of the `Ice.ServerId` property for the server id. The servant implements the shutdown operation by invoking `shutdown` on the object adapter's communicator.

It is important for a server to be registered with the locator registry so that services such as IceGrid can request a graceful shutdown when necessary. If a server is not registered, then platform-specific techniques are used to request a shutdown, and these techniques are not always effective (especially on Windows platforms).

Only one object adapter in a server should register with a locator registry. The `Ice::Process` servant represents a potential target for denial-of-service attacks. The object adapter uses a UUID to make the proxy more difficult to guess, but the object adapter should be configured with secure endpoints if the server operates in a potentially hostile environment. Alternatively, a dedicated object adapter can be created specifically to provide a restricted access point for services such as IceGrid.

adapter.Router

Synopsis

adapter.Router=router

Description

Specifies a router for the object adapter with the name *adapter*. The value is a stringified proxy to the Ice router control interface. Defining a router allows the object adapter to receive callbacks from the router over outgoing connections from this process to the router, thereby avoiding the need for the router to establish a connection back to the object adapter.

A router can only be assigned to one object adapter. Specifying the same router for more than one object adapter results in undefined behavior. The default value is no router.

adapter.ThreadPool.Size

Synopsis

adapter.ThreadPool.Size=num

Description

A communicator creates a default server thread pool that dispatches requests to its object adapters. An object adapter can also be configured with its own thread pool. This is useful in avoiding deadlocks due to thread starvation by ensuring that a minimum number of threads is available for dispatching requests to certain Ice objects.

num is the initial and also minimum number of threads in the thread pool. The default value is zero, meaning that an object adapter by default uses the communicator's server thread pool. See `Ice.ThreadPool.Server.Size` for more information.

adapter.ThreadPool.SizeMax

Synopsis

adapter.ThreadPool.SizeMax=num

Description

num is the maximum number of threads for the thread pool. Thread pools in Ice can grow and shrink dynamically, based on an average load factor. This thread pool will not grow larger than *num*, and does not shrink to a number of threads smaller than the value specified by `adapter.ThreadPool.Size`.

The default value is the value of `adapter.ThreadPool.Size`, meaning that by default, this thread pool does not grow dynamically.

adapter.ThreadPool.SizeWarn

Synopsis

adapter.ThreadPool.SizeWarn=num

Description

Whenever *num* threads are active in a thread pool, a "low on threads" warning is printed. The default value for is 80% of the value specified by *adapter.ThreadPool.SizeMax*.

adapter.ThreadPool.StackSize

Synopsis

adapter.ThreadPool.StackSize=num

Description

num is the stack size (in bytes) of threads in the thread pool. The default value is zero, meaning the operating system's default is used.

Ice.PrintAdapterReady

Synopsis

Ice.PrintAdapterReady=num

Description

If *num* is set to a value larger than zero, an object adapter prints "*adapter_name* ready" on standard output after initialization is complete. This is useful for scripts that need to wait until an object adapter is ready to be used.

C.5 Ice Plugin Properties

Ice.Plugin.name

Synopsis

Ice.Plugin.name=entry_point [args]

Description

Defines a plugin to be installed during communicator initialization.

Platform Notes

C++

The value of *entry_point* has the form *basename*[, *version*]:*function*. The *basename* and optional *version* components are used to construct the name of a DLL or shared library. If no version is supplied, the Ice version is used. The *function* component is the name of a function with C linkage. For example, the entry point `MyPlugin, 3.1:create` would imply a shared library name of `libMyPlugin.so.3.1` on Unix and `MyPlugin31.dll` on Windows. Furthermore, if Ice is built on Windows with debugging, a `d` is automatically appended to the version (for example, `MyPlugin31d.dll`).

Java

The value of *entry_point* is the name of a class that must implement the `Ice.PluginFactory` interface. Any arguments that follow the class name are passed to the `create` method.

.NET

The value of *entry_point* has the form *assembly*:*class*. The assembly can be the full assembly name, such as `myplugin, Version=0.0.0.0, Culture=neutral`, or an assembly DLL name such as `myplugin.dll`. The specified class must implement the `Ice.PluginFactory` interface. Any arguments that follow the class name are passed to the `create` method.

Ice.PluginLoadOrder

Synopsis

`Ice.PluginLoadOrder=names`

Description

Determines the order in which plugins are loaded. The Ice run time loads the plugins in the order they appear in *names*, where each plugin name is separated by a comma or white space. Any plugins not mentioned in *names* are loaded afterward, in an undefined order.

Ice.InitPlugins

Synopsis

`Ice.InitPlugins=num`

Description

If *num* is a value greater than zero, the Ice run time automatically initializes the plugins it has loaded. The order in which plugins are loaded and initialized is determined by `Ice.PluginLoadOrder`. An application may need to set this property to zero in order to interact directly with a plugin after it has been loaded but before it is initialized. In this case, the application must invoke `initializePlugins` on the plugin manager to complete the initialization process. If not defined, the default value is 1.

C.6 Ice Thread Pool Properties

Ice.ThreadPool.Client.Size Ice.ThreadPool.Server.Size

Synopsis

`Ice.ThreadPool.Client.Size=num`
`Ice.ThreadPool.Server.Size=num`

Description

A communicator creates two thread pools: the client thread pool dispatches AMI callbacks and incoming requests on bidirectional connections, and the server thread pool dispatches requests to object adapters. *num* is the initial and also minimum number of threads in the thread pool. The default value is one for both properties.

An object adapter can also be configured with its own thread pool. See the object adapter properties for more information.

Multiple threads for the client thread pool are only required for nested AMI invocations. If AMI is not used, or AMI calls are not nested (i.e., AMI callbacks do not invoke any other operations on Ice objects), then there is no need to set the number of threads in the client thread pool to a value larger than one.

Ice.ThreadPool.Client.SizeMax **Ice.ThreadPool.Server.SizeMax**

Synopsis

```
Ice.ThreadPool.Client.SizeMax=num  
Ice.ThreadPool.Server.SizeMax=num
```

Description

num is the maximum number of threads for the thread pool. Thread pools in Ice can grow and shrink dynamically, based on an average load factor. Thread pools do not grow larger than the number specified by `SizeMax`, and they do not shrink to a number of threads smaller than the value specified by `Size`.

The default value for `SizeMax` is the value of `Size`, meaning that by default, thread pools do not grow dynamically.

Ice.ThreadPool.Client.SizeWarn **Ice.ThreadPool.Server.SizeWarn**

Synopsis

```
Ice.ThreadPool.Client.SizeWarn=num  
Ice.ThreadPool.Server.SizeWarn=num
```

Description

Whenever *num* threads are active in a thread pool, a "low on threads" warning is printed. The default value for `SizeWarn` is 80% of the value specified by `SizeMax`.

**Ice.ThreadPool.Client.StackSize
Ice.ThreadPool.Server.StackSize****Synopsis**

`Ice.ThreadPool.Client.StackSize=num`
`Ice.ThreadPool.Server.StackSize=num`

Description

num is the stack size (in bytes) of threads in the thread pool. The default value is zero meaning the operating system's default is used.

C.7 Ice Default and Override Properties

Ice.Default.Protocol**Synopsis**

`Ice.Default.Protocol=protocol`

Description

Sets the protocol that is being used if an endpoint uses default as the protocol specification. The default value is `tcp`.

Ice.Default.Host**Synopsis**

`Ice.Default.Host=host`

Description

If an endpoint is specified without a host name (i.e., without a `-h host` option), the `host` value from this property is used instead. The property has no default value.

Ice.Default.Router**Synopsis**

`Ice.Default.Router=router`

Description

Specifies the default router for all proxies. The value is a stringified proxy to the Glacier2 router control interface. The default router can be overridden on a proxy using the `ice_router` operation. The default value is no router.

Ice.Default Locator**Synopsis**

`Ice.Default.Locator=locator`

Description

Specifies a default locator for all proxies and object adapters. The value is a stringified proxy to the IceGrid locator interface. The default locator can be overridden on a proxy using the `ice_locator` operation. The default value is no locator.

The default identity of the IceGrid locator object is `IceGrid/Locator` (see `IceGrid.InstanceName`). It is listening on the IceGrid client endpoints. For example, if `IceGrid.Registry.Client.Endpoints` is set to `tcp -p 12000 -h localhost`, the stringified proxy for the IceGrid locator is `IceGrid/Locator:tcp -p 12000 -h localhost`.

Ice.Default.LocatorCacheTimeout**Synopsis**

`Ice.Default.LocatorCacheTimeout=num`

Description

Specifies the default locator cache timeout for indirect proxies. If *num* is set to a value larger than zero, locator cache entries older than *num* seconds will be ignored. If set to 0, the locator cache won't be used. If set to -1, locator cache entries won't expire.

Ice.Default.CollocationOptmization

Synopsis

`Ice.Default.CollocationOptmization=num`

Description

Specifies whether proxy invocations use collocation optimization by default. When enabled, proxy invocations on a collocated servant (i.e., a servant whose object adapter was created by the same communicator as the proxy) are made as a direct method call if possible. Collocated invocations are more efficient because they avoid the overhead of marshaling parameters and sending requests over the network.

Collocation optimization is not supported for asynchronous or Dynamic Ice invocations, nor is it supported in Ice for Python and Ice for Ruby.

If not specified, the default value is 1. Set the property to 0 to disable collocation optimization by default.

Ice.Override.Timeout

Synopsis

`Ice.Override.Timeout=num`

Description

If set, this property overrides timeout settings in all endpoints. *num* is the timeout value in milliseconds, or -1 for no timeout.

Ice.Override.ConnectTimeout

Synopsis

`Ice.Override.ConnectTimeout=num`

Description

This property overrides timeout settings used to establish connections. *num* is the timeout value in milliseconds, or -1 for no timeout. If this property is not set, then `Ice.Override.Timeout` is used.

Ice.Override.Compress

Synopsis

`Ice.Override.Compress=num`

Description

If set, this property overrides compression settings in all proxies. If *num* is set to a value larger than zero, compression is enabled. If zero, compression is disabled. The setting of this property is ignored in the server role.

Note that, if a client sets `Ice.Override.Compress=1` and sends a compressed request to a server that does not support compression, the server will close the connection and the client will receive `ConnectionLostException`.

If a client does not support compression and `Ice.Override.Compress=1`, the setting is ignored and a warning message is printed on `stderr`.

Regardless of the setting of this property, requests smaller than 100 bytes are never compressed.

C.8 Ice Miscellaneous Properties

Ice.ThreadPerConnection

Synopsis

`Ice.ThreadPerConnection=num`

Description

If *num* is set to a value larger than zero, the Ice run time uses a thread-per-connection concurrency model instead of the default thread pool. As its name implies, this concurrency model creates a new thread for each outgoing and incoming connection. Unlike the thread pool concurrency model, thread-per-connection supports at most one level of nested callbacks.

Ice.GC.Interval**Synopsis**

`Ice.GC.Interval=num`

Description

This property determines the frequency with which the class garbage collector runs. If the interval is set to zero (the default), no collector thread is created. Otherwise, the collector thread runs every *num* seconds.

Ice.RetryIntervals**Synopsis**

`Ice.RetryIntervals=num [num ...]`

Description

This property defines the number of times an operation is re-tried and the delay between each retry. For example, if the property is set to `0 100 500`, the operation is re-tried 3 times: immediately after the first failure, again after waiting 100ms after the second failure, and again after waiting 500ms after the third failure. The default value (`0`) is to retry once immediately. If set to `-1`, no retry occurs.

Ice.MessageSizeMax**Synopsis**

`Ice.MessageSizeMax=num`

Description

This property controls the maximum size (in kilobytes) of a protocol message that is accepted or sent by the Ice run time. The size includes the size of the Ice protocol header. Messages larger than this size cause a `MemoryLimitException`. The default size is 1024 (1 Megabyte). Settings with a value less than 1 are ignored.

This property adjusts the value of `Ice.UDP.RcvSize` and `Ice.UDP.SndSize`, that is, if `Ice.UDP.RcvSize` or `Ice.UDP.SndSize` are larger than `Ice.MessageSizeMax * 1024 + 28`, they are adjusted to `Ice.MessageSizeMax * 1024 + 28`.

Ice.ChangeUser

Synopsis

`Ice.ChangeUser=user`

Description

If set, Ice changes the user and group id to the respective ids of *user* in `/etc/passwd`. This only works if the Ice application is executed by the super-user (Unix only).

Ice.ACM.Client

Synopsis

`Ice.ACM.Client=num`

Description

If *num* is set to a value larger than zero, client-side Active Connection Management (ACM) is enabled. This means that connections are automatically closed by the client after they have been idle for *num* seconds. This is transparent to applications because connections closed by ACM are automatically reestablished if they are needed again. The default value is 60, meaning that idle connections are automatically closed after one minute.

Ice.ACM.Server

Synopsis

Ice.ACM.Server=*num*

Description

This property is the server-side equivalent of Ice.ACM.Client. If *num* is set to a value larger than zero, server-side Active Connection Management (ACM) is enabled, in which the server automatically closes an incoming connection after it has been idle for *num* seconds. The default value is 0, meaning that server-side ACM is disabled by default.

Server-side ACM can cause incoming oneway requests to be silently discarded. See the Ice manual for more information.

Ice.MonitorConnections

Synopsis

Ice.MonitorConnections=*num*

Description

If *num* is set to a value larger than zero, Ice starts a thread that monitors connections. Approximately every *num* seconds, this thread shuts down idle connections and enforces AMI timeouts. The default value is the smaller of Ice.ACM.Client or Ice.ACM.Server. If neither property is defined with a non-zero value, the monitoring thread is disabled.

It is important to understand the relationship between this thread and the timeouts it is responsible for enforcing. It is legal to define Ice.ACM.Client or Ice.ACM.Server with a value smaller than *num*, but idle connections will only be closed every *num* seconds. Similarly, AMI timeouts cannot happen faster than *num* seconds.

Ice.PrintProcessId

Synopsis

Ice.PrintProcessId=*num*

Description

If *num* is set to a value larger than zero, the process ID is printed on standard output upon startup.

Ice.ProgramName**Synopsis**

`Ice.ProgramName=name`

Description

name is the program name, which is set automatically from `argv[0]` (C++) and from `AppDomain.CurrentDomain.FriendlyName` (C#) during initialization. (For Java, `Ice.ProgramName` is initialized to the empty string.) For all languages, the default name can be overridden by setting this property.

Ice.ServerId**Synopsis**

`Ice.ServerId=id`

Description

The value *id* is used as the server id when an object adapter registers the server with the locator registry. Refer to the description of the object adapter property `adapter.RegisterProcess` for more information.

Ice.ServerIdleTime**Synopsis**

`Ice.ServerIdleTime=num`

Description

If *num* is set to a value larger than zero, Ice automatically calls `Communicator::shutdown` once the communicator has been idle for *num* seconds. This shuts down the Communicator's server side and causes all threads waiting in

`Communicator::waitForShutdown` to return. After that, a server will typically do some clean-up work before exiting. The default value is zero, meaning that the server will not shut down automatically.

Ice.StdErr

Synopsis

`Ice.StdErr=filename`

Description

If *filename* is not empty, the standard error stream of this process is redirected to this file, in append mode. This property is checked only for the first communicator that is created in a process.

Ice.StdOut

Synopsis

`Ice.StdOut=filename`

Description

If *filename* is not empty, the standard output stream of this process is redirected to this file, in append mode. This property is checked only for the first communicator created in a process.

Ice.UseEventLog

Synopsis

`Ice.UseEventLog=num`

Description

If *num* is set to a value larger than zero, a special logger is installed that logs to the Windows event log instead of standard error. The event source name is the value of `Ice.ProgramName` (Windows 2000/XP only).

Ice.UseSyslog

Synopsis

`Ice.UseSyslog=num`

Description

If *num* is set to a value larger than zero, a special logger is installed that logs to the `syslog` facility instead of standard error. The identifier for `syslog` is the value of `Ice.ProgramName` (Unix only).

Ice.Logger.Timestamp

Synopsis

`Ice.Logger.Timestamp=num`

Description

If *num* is set to a value larger than zero, the output of the default logger includes timestamps.

Ice.NullHandleAbort

Synopsis

`Ice.NullHandleAbort=num`

Description

If *num* is set to a value larger than zero, invoking an operation using a null smart pointer causes the program to abort immediately instead of raising `IceUtil::NullHandleException` (C++ only).

Ice.Nohup

Synopsis

`Ice.Nohup=num`

Description

If *num* is set to a value larger than zero, the C++ classes `Ice::Application` and `Ice::Service` ignore `SIGHUP` (for UNIX) and `CTRL_LOGOFF_EVENT` (for Windows). As a result, an application that sets `Ice.Nohup` continues to run if the user that started the application logs off. The default value for `Ice::Application` is 0, and the default value for `Ice::Service` is 1 (C++ only.)

`Ice.UDP.RcvSize` `Ice.UDP.SndSize`

Synopsis

```
Ice.UDP.RcvSize=num  
Ice.UDP.SndSize=num
```

Description

These properties set the UDP receive and send buffer sizes to the specified value in bytes. Ice messages larger than *num* - 28 bytes cause a `DatagramLimitException`. The default value depends on the configuration of the local UDP stack. (Common default values are 65535 and 8192 bytes.)

The OS may impose lower and upper limits on the receive and send buffer sizes or otherwise adjust the buffer sizes. If a limit is requested that is lower than the OS-imposed minimum, the value is silently adjusted to the OS-imposed minimum. If a limit is requested that is larger than the OS-imposed maximum, the value is adjusted to the OS-imposed maximum; in addition, Ice logs a warning showing the requested size and the adjusted size.

Settings of these properties less than 28 are ignored.

Note that, on many operating systems, it is possible to set buffer sizes greater than 65535. Such settings do not change the hard limit of 65507 bytes for the payload of a UDP packet, but merely affect how much data can be buffered by the kernel.

Settings less than 65535 limit the size of Ice datagrams as well as adjust the kernel buffer sizes.

If `Ice.MessageSizeMax` is set and `Ice.MessageSizeMax * 1024 + 28` is smaller than the UDP receive or send buffer size, the corresponding UDP buffer size is reduced to `Ice.MessageSizeMax * 1024 + 28`.

Ice.Package.module

Synopsis

`Ice.Package.module=package`

Description

Associates a top-level Slice *module* with a Java *package*. If global metadata is used to enclose generated Java classes in a user-defined package, the Ice run time must be configured in order to successfully unmarshal exceptions and concrete class types. If all top-level modules are generated into the same user-defined package, it is easier to use `Ice.Default.Package` instead.

Ice.Default.Package

Synopsis

`Ice.Default.Package=package`

Description

Specifies a default package to use if other attempts by the Ice run time to dynamically load a generated class have failed. If global metadata is used to enclose generated Java classes in a user-defined package, the Ice run time must be configured in order to successfully unmarshal exceptions and concrete class types. See also `Ice.Package.module`.

Ice.Compression.Level

Synopsis

`Ice.Compression.Level=num`

Description

Specifies the bzip2 compression level. Legal values for *num* are 1 to 9, where 1 represents the fastest compression and 9 represents the best compression. Note that higher levels cause the bzip2 algorithm to devote more resources to the compression effort, and may not result in a significant improvement over lower levels. If not specified, the default value is 1.

C.9 IceSSL Properties

IceSSL.Alias

Synopsis

IceSSL.Alias=*alias* (Java)

Description

Selects a particular certificate from the key store specified by IceSSL.Keystore. The certificate identified by *alias* is presented to the peer request during authentication.

IceSSL.CertAuthDir

Synopsis

IceSSL.CertAuthDir=*path* (C++)

Description

Specifies the directory containing the certificates of trusted certificate authorities. The directory must be prepared in advance using the OpenSSL utility `c_rehash`. The path name may be specified relative to the default directory defined by IceSSL.DefaultDir.

IceSSL.CertAuthFile

Synopsis

IceSSL.CertAuthFile=*file* (C++)

Description

Specifies a file containing the certificate of a trusted certificate authority. The file name may be specified relative to the default directory defined by IceSSL.DefaultDir. The certificate must be encoded using the PEM format.

IceSSL.CertFile

Synopsis

IceSSL.CertFile=*file* (C++, .NET)

Description

Specifies a file that contains the program's certificate, and may also contain the corresponding private key. The file name may be specified relative to the default directory defined by IceSSL.DefaultDir.

Platform Notes

C++

The private key is optional; if not present, the file containing the private key must be identified by IceSSL.KeyFile. If a password is required, OpenSSL will prompt the user at the terminal unless the application has installed a password handler or supplied the password using IceSSL.Password. The certificate must be encoded using the PEM format.

.NET

The file must use the PFX (PKCS#12) format and contain the certificate and its private key. The password for the file must be supplied using IceSSL.Password.

IceSSL.CheckCertName

Synopsis

IceSSL.CheckCertName=*num*

Description

If *num* is a value greater than zero, IceSSL compares the server's host name as specified in the proxy against the DNS or IP address fields of the server's certificate. If no match is found, IceSSL aborts the connection attempt and raises an exception. If not defined, the default value is zero.

IceSSL.CheckCRL

Synopsis

IceSSL .CheckCRL=*num* (.NET)

Description

If *num* is a value greater than zero, IceSSL checks the certificate revocation list to determine if the peer's certificate has been revoked. If so, IceSSL aborts the connection and raises an exception.

IceSSL.Ciphers

Synopsis

IceSSL .Ciphers=*ciphers* (C++, Java)

Description

Specifies the cipher suites that IceSSL is allowed to negotiate. A cipher suite is a set of algorithms that satisfies the four requirements for establishing a secure connection: signing and authentication, key exchange, secure hashing, and encryption. Some algorithms satisfy more than one requirement, and there are many possible combinations.

Platform Notes

C++

The value of this attribute is given directly to the OpenSSL library and is dependent on how OpenSSL was compiled. You can obtain a complete list of the supported cipher suites using the command **openssl ciphers**. This command will likely generate a long list. To simplify the selection process, OpenSSL supports several classes of ciphers. Classes and ciphers can be excluded by prefixing them with an exclamation point. The special keyword **@STRENGTH** sorts the cipher list in order of their strength, so that SSL gives

preference to the more secure ciphers when negotiating a cipher suite. The @STRENGTH keyword must be the last element in the list. The classes are:

ALL	Enables all supported cipher suites. This class should be used with caution, as it may enable low-security cipher suites.
ADH	Anonymous ciphers.
LOW	Low bit-strength ciphers.
EXP	Export-crippled ciphers.

Here is an example of a reasonable setting:

```
ALL:!ADH:!LOW:!EXP:!MD5:@STRENGTH
```

This value excludes the ciphers with low bit-strength and known problems, and orders the remaining ciphers according to their strength. Note that no warning is given if an unrecognized cipher is specified.

Java

The property value is interpreted as a list of tokens delimited by white space. The plugin executes the tokens in the order of appearance in order to assemble the list of enabled cipher suites. The table below describes the tokens:

NONE	Disables all cipher suites. If specified, it must be the first token in the list.
ALL	Enables all supported cipher suites. If specified, it must be the first token in the list. This token should be used with caution, as it may enable low-security cipher suites.
NAME	Enables the cipher suite matching the given name.
!NAME	Disables the cipher suite matching the given name.
(EXP)	Enables cipher suites whose names contain the regular expression <i>EXP</i> . For example, the value NONE (. *DH_anon. *) selects only cipher suites that use anonymous Diffie-Hellman authentication.
!(EXP)	Disables cipher suites whose names contain the regular expression <i>EXP</i> . For example, the value ALL !(. *DH_anon. *) enables all cipher suites except those that use anonymous Diffie-Hellman authentication.

If not specified, the plugin uses the security provider's default cipher suites. Set `IceSSL.Trace.Security=1` to determine which cipher suites are enabled by default, or to verify your cipher suite configuration.

IceSSL.DefaultDir

Synopsis

`IceSSL.DefaultDir=path`

Description

Specifies the default directory in which to look for certificate, key, and key store files. See the descriptions of the relevant properties for more information.

IceSSL.DH.bits

Synopsis

IceSSL.DH.bits=*file* (C++)

Description

Specifies a *file* containing Diffie Hellman parameters whose key length is *bits*, as shown in the following example:

```
IceSSL.DH.1024=dhparams1024.pem
```

IceSSL supplies default parameters for key lengths of 512, 1024, 2048, and 4096 bits, which are used if no user-defined parameters of the desired key length are specified. The file name may be specified relative to the default directory defined by IceSSL.DefaultDir. The parameters must be encoded using the PEM format.

IceSSL.EntropyDaemon

Synopsis

IceSSL.EntropyDaemon=*file* (C++)

Description

Specifies a Unix domain socket for the entropy gathering daemon, from which OpenSSL gathers entropy data to initialize its random number generator.

IceSSL.FindCert.location.name

Synopsis

IceSSL.FindCert.location.name=*criteria* (.NET)

Description

Queries the certificate repository for matching certificates and adds them to the application's collection of certificates that are used for authentication. The value for *location* must be LocalMachine or CurrentUser.

The *name* corresponds to the .NET enumeration StoreName and may be one of the following values: AddressBook, AuthRoot, CertificateAuthority,

Disallowed, My, Root, TrustedPeople, TrustedPublisher. It is also possible to use an arbitrary value for *name*.

The value for *criteria* may be *, in which case all of the certificates in the store are selected. Otherwise, *criteria* must be one or more *field:value* pairs separated by white space. The valid field names are described below:

Issuer	Matches a substring of the issuer's name.
IssuerDN	Matches the issuer's entire distinguished name.
Serial	Matches the certificate's serial number.
Subject	Matches a substring of the subject's name.
SubjectDN	Matches the subject's entire distinguished name.
SubjectKeyId	Matches the certificate's subject key identifier.
Thumbprint	Matches the certificate's thumbprint.

The field names are case-insensitive. If multiple criteria are specified, only certificates that match all criteria are selected. Values must be enclosed in single or double quotes to preserve white space.

Multiple occurrences of the property are allowed, but only one query is possible for each location/name combination. The certificates from all queries are combined to form the certificate collection, including a certificate loaded using `IceSSL.CertFile`. Here are some sample queries:

```
IceSSL.FindCert.LocalMachine.My=issuer:verisign serial:219336
IceSSL.FindCert.CurrentUser.Root=subject:"Joe's Certificate"
```

A server requires a certificate for authentication purposes, therefore `IceSSL` selects the first certificate in the accumulated collection. This is normally the certificate loaded via `IceSSL.CertFile`, if that property was defined. Otherwise, one of the certificates from `IceSSL.FindCert` is selected. Since `IceSSL` does not guarantee the order in which it evaluates `IceSSL.FindCert` properties, it is recommended that the criteria select only one certificate.

IceSSL.ImportCert.*location.name*

Synopsis

IceSSL.ImportCert.*location.name*=*file*[:*password*] (.NET)

Description

Imports the certificate in *file* into the specified certificate store. The value for *location* must be LocalMachine or CurrentUser. The *name* corresponds to the .NET enumeration StoreName and may be one of the following values: AddressBook, AuthRoot, CertificateAuthority, Disallowed, My, Root, TrustedPeople, TrustedPublisher. It is also possible to use an arbitrary value for *name*, which adds a new store to the repository. If you are importing a trusted CA certificate, it must be added to AuthRoot or Root.

The *password* is optional; it is only necessary if the certificate file also contains a private key or uses a secure storage format such as PFX.

The file name and password may be enclosed in single or double quotes if necessary. The file name may be specified relative to the default directory defined by IceSSL.DefaultDir.

Importing a certificate into LocalMachine requires administrator privileges, while importing into CurrentUser may cause the platform to prompt the user for confirmation.

IceSSL.KeyFile

Synopsis

IceSSL.KeyFile=*file* (C++)

Description

Specifies a file containing the private key associated with the certificate identified by IceSSL.CertFile. The file name may be specified relative to the default directory defined by IceSSL.DefaultDir. The key must be encoded using the PEM format.

IceSSL.Keystore

Synopsis

IceSSL.Keystore=*file* (Java)

Description

Specifies a key store file containing certificates and their private keys. If the key store contains multiple certificates, you should specify a particular one to use for authentication using IceSSL.Alias. The file name may be specified relative to the default directory defined by IceSSL.DefaultDir. The format of the file is determined by IceSSL.KeystoreType.

If this property is not defined, the application will not be able to supply a certificate during SSL handshaking. As a result, the application may not be able to negotiate a secure connection, or might be required to use an anonymous cipher suite.

IceSSL.KeystorePassword

Synopsis

IceSSL.KeystorePassword=*password* (Java)

Description

Specifies the password used to verify the integrity of the key store defined by IceSSL.Keystore. The integrity check is skipped if this property is not defined. It is a security risk to use a plain-text password in a configuration file.

IceSSL.KeystoreType

Synopsis

IceSSL.KeystoreType=*type* (Java)

Description

Specifies the format of the key store file defined by IceSSL.Keystore. Legal values are JKS and PKCS12. If not defined, the JVM's default value is used (normally JKS).

IceSSL.Password

Synopsis

IceSSL.Password=*password*

Description

Specifies the password necessary to decrypt the private key.

Platform Notes

C++

This property supplies the password that was used to secure the private key contained in the file defined by IceSSL.CertFile or IceSSL.KeyFile. If this property is not defined and you have not installed a password callback object, OpenSSL will prompt the user for a password if one is necessary.

Java

This property supplies the password that was used to secure the private key contained in the key store defined by IceSSL.Keystore. All of the keys in the key store must use the same password.

.NET

This property supplies the password that was used to secure the file defined by IceSSL.CertFile.

It is a security risk to use a plain-text password in a configuration file.

IceSSL.PasswordRetryMax

Synopsis

IceSSL.PasswordRetryMax=*num* (C++)

Description

Specifies the number of attempts IceSSL should allow the user to make when entering a password. If not defined, the default value is 3.

IceSSL.Protocols

Synopsis

`IceSSL.Protocols=`*list*

Description

Specifies the protocols to allow during SSL handshaking. Legal values are SSL3 and TLS1. You may also specify both values, separate by commas or white space. If this property is not defined, the platform's default is used.

IceSSL.Random

Synopsis

`IceSSL.Random=`*filelist* (C++, Java)

Description

Specifies one or more files containing data to use when seeding the random number generator. The file names should be separated using the platform's path separator (a colon on Unix and a semicolon on Windows). The file names may be specified relative to the default directory defined by `IceSSL.DefaultDir`.

IceSSL.Trace.Security

Synopsis

`IceSSL.Trace.Security=`*num*

Description

The SSL plugin trace level:

0	No security tracing (default).
1	Display diagnostic information about SSL connections.

IceSSL.TrustOnly

Synopsis

```
IceSSL.TrustOnly=ENTRY[;ENTRY;...]
```

Description

Identifies trusted peers. This family of properties provides an additional level of authentication by restricting connections to trusted peers. After the SSL engine has successfully completed its authentication process, IceSSL compares the peer's distinguished name (DN) with each *ENTRY* in the property value and allows the connection to succeed if the peer's DN matches any of the entries. *ENTRY* must contain only those relative distinguished name (RDN) components that a peer is required to have in its DN. IceSSL rejects a connection if no match is found for the peer's DN, or if the peer did not supply a certificate.

For example, you can limit access to people in the sales and marketing departments using the following configuration:

```
IceSSL.TrustOnly=0="Acme, Inc.",OU="Sales"; 0="Acme, Inc.",OU="Marketing"
```

The peer's DN must match one of these entries in order to establish a connection.

An entry may contain as many RDN components as you wish, depending on how narrowly you need to restrict access. The order of the RDN components is not important.

To specify more than one entry, separate them using semicolons. IceSSL expects each entry to be formatted according to the rules defined by RFC2253.

While testing your trust configuration, you may find it helpful to set the `IceSSL.Trace.Security` property to a non-zero value, which causes IceSSL to display the DN of each peer during connection establishment.

This property affects incoming and outgoing connections. IceSSL also supports similar properties that affect only incoming connections or only outgoing connections.

IceSSL.TrustOnly.Client

Synopsis

```
IceSSL.TrustOnly.Client=ENTRY[;ENTRY;...]
```

Description

Identifies trusted peers for outgoing (client) connections. For a connection to succeed, the peer's distinguished name (DN) must match an entry in this property or in `IceSSL.TrustOnly`.

IceSSL.TrustOnly.Server**Synopsis**

```
IceSSL.TrustOnly.Server=ENTRY[;ENTRY;...]
```

Description

Identifies trusted peers for incoming ("server") connections. For a connection to succeed, the peer's distinguished name (DN) must match an entry in this property or in `IceSSL.TrustOnly`. To configure trusted peers for a particular object adapter, use `IceSSL.TrustOnly.Server.AdapterName`.

IceSSL.TrustOnly.Server.AdapterName**Synopsis**

```
IceSSL.TrustOnly.Server.AdapterName=ENTRY[;ENTRY;...]
```

Description

Identifies trusted peers for incoming (server) connections to the object adapter `AdapterName`. For a connection to succeed, the peer's distinguished name (DN) must match an entry in this property, an entry in `IceSSL.TrustOnly.Server`, or an entry in `IceSSL.TrustOnly`.

IceSSL.Truststore**Synopsis**

```
IceSSL.Truststore=file (Java)
```

Description

Specifies a key store file containing the certificates of trusted certificate authorities. The file name may be specified relative to the default directory defined by

`IceSSL.DefaultDir`. The format of the file is determined by `IceSSL.TruststoreType`.

If this property is not defined, the application will not be able to authenticate the peer's certificate during SSL handshaking. As a result, the application may not be able to negotiate a secure connection, or might be required to use an anonymous cipher suite.

IceSSL.TruststorePassword

Synopsis

`IceSSL.TruststorePassword=password` (Java)

Description

Specifies the password used to verify the integrity of the key store defined by `IceSSL.Truststore`. The integrity check is skipped if this property is not defined. It is a security risk to use a plain-text password in a configuration file.

IceSSL.TruststoreType

Synopsis

`IceSSL.TruststoreType=type` (Java)

Description

Specifies the format of the key store file defined by `IceSSL.Truststore`. Legal values are JKS and PKCS12. If not defined, the default value is JKS.

IceSSL.VerifyDepthMax

Synopsis

`IceSSL.VerifyDepthMax=num`

Description

Specifies the maximum depth of a trusted peer's certificate chain, including the peer's certificate. A value of zero accepts chains of any length. If not defined, the default value is 2.

IceSSL.VerifyPeer

Synopsis

IceSSL.VerifyPeer=*num*

Description

Specifies the verification requirements to use during SSL handshaking. The legal values are shown in the table below. If this property is not defined, the default value is 2.

0	For an outgoing connection, the client verifies the server's certificate (if an anonymous cipher is not used) but does not abort the connection if verification fails. For an incoming connection, the server does not request a certificate from the client.
1	For an outgoing connection, the client verifies the server's certificate and aborts the connection if verification fails. For an incoming connection, the server requests a certificate from the client and verifies it if one is provided, aborting the connection if verification fails.
2	For an outgoing connection, the semantics are the same as for the value 1. For an incoming connection, the server requires a certificate from the client and aborts the connection if verification fails.

Platform Notes

.NET

This property has no effect on outgoing connections, since .NET always uses the semantics of value 2. For an incoming connection, the value 0 has the same semantics as the value 1.

C.10 IceBox Properties

IceBox.InstanceName

Synopsis

`IceBox.InstanceName=name`

Description

Specifies an alternate identity category for the IceBox service manager object. If defined, the identity of the object becomes *name/ServiceManager*. If not specified, the default identity category is IceBox.

IceBox.ServiceManager.AdapterId

Synopsis

`IceBox.ServiceManager.AdapterId=id`

Description

Defines the value of the property *adapter.AdapterId* for the object adapter named `IceBox.ServiceManager`.

IceBox.ServiceManager.ReplicaGroupId

Synopsis

`IceBox.ServiceManager.ReplicaGroupId=id`

Description

Defines the value of the property *adapter.ReplicaGroupId* for the object adapter named `IceBox.ServiceManager`.

IceBox.ServiceManager.Endpoints

Synopsis

`IceBox.ServiceManager.Endpoints=endpoints`

Description

Defines the endpoints of the IceBox service manager interface. The service manager endpoints must be accessible to the IceBox administration tool to shut-down the IceBox server.

IceBox.ServiceManager.PublishedEndpoints**Synopsis**

`IceBox.ServiceManager.PublishedEndpoints=endpoints`

Description

Defines the published endpoints of the IceBox service manager interface. The service manager endpoints must be accessible to the IceBox administration tool to shutdown the IceBox server. Refer to the description of the object adapter property `adapter.PublishedEndpoints` for more information.

IceBox.ServiceManager.RegisterProcess**Synopsis**

`IceBox.ServiceManager.RegisterProcess=num`

Description

Defines the value of the property `adapter.RegisterProcess` for the object adapter named `IceBox.ServiceManager`.

IceBox.ServiceManager.ThreadPool.Size**Synopsis**

`IceBox.ServiceManager.ThreadPool.Size=num`

Description

Defines the value of the property `adapter.ThreadPool.Size` for the object adapter named `IceBox.ServiceManager`.

IceBox.ServiceManager.ThreadPool.SizeMax

Synopsis

IceBox.ServiceManager.ThreadPool.SizeMax=*num*

Description

Defines the value of the property *adapter.ThreadPool.SizeMax* for the object adapter named IceBox.ServiceManager.

IceBox.ServiceManager.ThreadPool.SizeWarn

Synopsis

IceBox.ServiceManager.ThreadPool.SizeWarn=*num*

Description

Defines the value of the property *adapter.ThreadPool.SizeWarn* for the object adapter named IceBox.ServiceManager.

IceBox.LoadOrder

Synopsis

IceBox.LoadOrder=*names*

Description

Determines the order in which services are loaded. The service manager loads the services in the order they appear in *names*, where each service name is separated by a comma or white space. Any services not mentioned in *names* are loaded afterward, in an undefined order.

IceBox.PrintServicesReady

Synopsis

IceBox.PrintServicesReady=*token*

Description

If this property is set to a value greater than zero, the service manager prints "*token ready*" on standard output once initialization of all the services is complete. This is useful for scripts that wish to wait until all services are ready to be used.

IceBox.Service.name

Synopsis

```
IceBox.Service.name=entry_point[,version] [args]
```

Description

Defines a service to be loaded during IceBox initialization.

In C++, *entry_point* has the form *basename*[, *version*]:*symbol*. The *basename* and optional *version* components are used to construct the name of a DLL or shared library. If no version is supplied, the version is the empty string. The *symbol* component is the name of a function with C linkage. For example, the entry point `icestormservice,31:createIceStorm` implies a shared library name of `libIceStormService.so.31` on Unix and `IceStormService31.dll` on Windows. Furthermore, if IceBox is built on Windows with debugging, a `d` is automatically appended to the version (e.g., `IceStormService31d.dll`).

In Java, *entry_point* is the name of the service implementation class.

IceBox.UseSharedCommunicator.name

Synopsis

```
IceBox.UseSharedCommunicator.name=num
```

Description

If *num* is set to a value larger than zero, the service manager supplies the service with the *name* of a communicator that might be shared by other services.

IceGrid Properties

IceGrid.InstanceName

Synopsis

IceGrid.InstanceName=*name*

Description

Specifies an alternate identity category for the IceGrid objects. If defined, the identities of the IceGrid objects become:

- name*/Admin
- name*/AdminSessionManager
- name*/AdminSSLSessionManager
- name*/NullPermissionsVerifier
- name*/Locator
- name*/Query
- name*/Registry
- name*/RegistryUserAccountMapper
- name*/SessionManager
- name*/SSLSessionManager

If not specified, the default identity category is IceGrid.

IceGrid.Registry.Admin.Endpoints

Synopsis

IceGrid.Registry.Admin.Endpoints=*endpoints*

Description

Defines the optional administrative endpoints of the IceGrid admin interface. The administrative endpoints must be accessible to clients that use the IceGrid administrative interface, such as the IceGrid administrative tools. These endpoints must also be accessible to Glacier2 routers that use the IceGrid client or admin session manager objects.

Allowing access to the IceGrid admin interface is a security risk! If this property is not defined, the admin interface is disabled.

IceGrid.Registry.Admin.PublishedEndpoints

Synopsis

IceGrid.Registry.Admin.PublishedEndpoints=*endpoints*

Description

Defines the optional administrative published endpoints of the IceGrid admin interface. The administrative endpoints must be accessible to clients that use the IceGrid administrative interface, such as the IceGrid administrative tool. These endpoints must also be accessible to Glacier2 routers that use the IceGrid client or admin session manager objects. Refer to the description of the object adapter property *adapter.PublishedEndpoints* for more information.

Allowing access to the IceGrid admin interface is a security risk!

IceGrid.Registry.Admin.ThreadPool.Size

Synopsis

IceGrid.Registry.Admin.ThreadPool.Size=*num*

Description

Defines the value of the property *adapter.ThreadPool.Size* for the object adapter named IceGrid.Registry.Admin.

IceGrid.Registry.Admin.ThreadPool.SizeMax

Synopsis

IceGrid.Registry.Admin.ThreadPool.SizeMax=*num*

Description

Defines the value of the property *adapter.ThreadPool.SizeMax* for the object adapter named IceGrid.Registry.Admin.

IceGrid.Registry.Admin.ThreadPool.SizeWarn

Synopsis

`IceGrid.Registry.Admin.ThreadPool.SizeWarn=num`

Description

Defines the value of the property `adapter.ThreadPool.SizeWarn` for the object adapter named `IceGrid.Registry.Admin`.

IceGrid.Registry.AdminCryptPasswords

Synopsis

`IceGrid.Registry.AdminCryptPasswords=file`

Description

Specifies the file name of an IceGrid registry access control list for admin clients. Each line of the file must contain a user name and a password, separated by white space. The password must be a 13-character crypt-encoded string. If this property is not defined, the default value is `admin-passwords`. This property is ignored if `IceGrid.Registry.AdminPermissionsVerifier` is defined.

IceGrid.Registry.AdminPermissionsVerifier

Synopsis

`IceGrid.Registry.AdminPermissionsVerifier=proxy`

Description

Specifies the proxy of an object that implements the `Glacier2::PermissionsVerifier` interface. The IceGrid registry invokes this proxy to validate each new admin session created by a client with the `IceGrid::Registry` interface.

IceGrid.Registry.AdminSSLPermissionsVerifier

Synopsis

`IceGrid.Registry.AdminSSLPermissionsVerifier=proxy`

Description

Specifies the proxy of an object that implements the `Glacier2::SSLPermissionsVerifier` interface. The IceGrid registry invokes this proxy to validate each new admin session created by a client from a secure connection with the `IceGrid::Registry` interface.

IceGrid.Registry.Client.Endpoints

Synopsis

`IceGrid.Registry.Client.Endpoints=endpoints`

Description

Defines the endpoints of the IceGrid client interface. The client endpoints must be accessible to Ice clients that use IceGrid to locate objects (see `Ice.Default.Locator`). This property must be defined.

IceGrid.Registry.Client.PublishedEndpoints

Synopsis

`IceGrid.Registry.Client.PublishedEndpoints=endpoints`

Description

Defines the published endpoints of the IceGrid client interface. The client endpoints must be accessible to Ice clients that use IceGrid to locate objects (see `Ice.Default.Locator`). Refer to the description of the object adapter property `adapter.PublishedEndpoints` for more information.

IceGrid.Registry.Client.ThreadPool.Size

Synopsis

IceGrid.Registry.Client.ThreadPool.Size=*num*

Description

Defines the value of the property *adapter.ThreadPool.Size* for the object adapter named IceGrid.Registry.Client.

IceGrid.Registry.Client.ThreadPool.SizeMax

Synopsis

IceGrid.Registry.Client.ThreadPool.SizeMax=*num*

Description

Defines the value of the property *adapter.ThreadPool.SizeMax* for the object adapter named IceGrid.Registry.Client.

IceGrid.Registry.Client.ThreadPool.SizeWarn

Synopsis

IceGrid.Registry.Client.ThreadPool.SizeWarn=*num*

Description

Defines the value of the property *adapter.ThreadPool.SizeWarn* for the object adapter named IceGrid.Registry.Client.

IceGrid.Registry.CryptPasswords

Synopsis

IceGrid.Registry.CryptPasswords=*file*

Description

Specifies the file name of an IceGrid registry access control list. Each line of the file must contain a user name and a password, separated by white space. The pass-

word must be a 13-character crypt-encoded string. If this property is not defined, the default value is `passwords`. This property is ignored if `IceGrid.Registry.PermissionsVerifier` is defined.

IceGrid.Registry.Data

Synopsis

`IceGrid.Registry.Data=`*path*

Description

Defines the path of the IceGrid registry data directory. This property must be defined, and *path* must already exist.

IceGrid.Registry.DefaultTemplates

Synopsis

`IceGrid.Registry.DefaultTemplates=`*path*

Description

Defines the path name of an XML file containing default template descriptors. A sample file named `config/templates.xml` that contains convenient server templates for Ice services is provided in the Ice distribution.

IceGrid.Registry.DynamicRegistration

Synopsis

`IceGrid.Registry.DynamicRegistration=`*num*

Description

If *num* is set to a value larger than zero, the locator registry does not require Ice servers to preregister object adapters and replica groups, but rather creates them automatically if they do not exist. If this property is not defined, or *num* is set to zero, an attempt to register an unknown object adapter or replica group causes adapter activation to fail with `Ice.NotRegisteredException`. An object adapter

registers itself when the *adapter.AdapterId* property is defined. The *adapter.ReplicaGroupId* property identifies the replica group.

IceGrid.Registry.Internal.Endpoints

Synopsis

`IceGrid.Registry.Internal.Endpoints=endpoints`

Description

Defines the endpoints of the IceGrid internal interface. The internal endpoints must be accessible to IceGrid nodes. Nodes use this interface to communicate with the registry. This property must be defined.

IceGrid.Registry.Internal.PublishedEndpoints

Synopsis

`IceGrid.Registry.Internal.PublishedEndpoints=endpoints`

Description

Defines the published endpoints of the IceGrid internal interface. The internal endpoints must be accessible to IceGrid nodes. Nodes use this interface to communicate with the registry. Refer to the description of the object adapter property *adapter.PublishedEndpoints* for more information.

IceGrid.Registry.Internal.ThreadPool.Size

Synopsis

`IceGrid.Registry.Internal.ThreadPool.Size=num`

Description

Defines the value of the property *adapter.ThreadPool.Size* for the object adapter named `IceGrid.Registry.Internal`.

IceGrid.Registry.Internal.ThreadPool.SizeMax

Synopsis

`IceGrid.Registry.Internal.ThreadPool.SizeMax=num`

Description

Defines the value of the property `adapter.ThreadPool.SizeMax` for the object adapter named `IceGrid.Registry.Internal`.

IceGrid.Registry.Internal.ThreadPool.SizeWarn

Synopsis

`IceGrid.Registry.Internal.ThreadPool.SizeWarn=num`

Description

Defines the value of the property `adapter.ThreadPool.SizeWarn` for the object adapter named `IceGrid.Registry.Internal`.

IceGrid.Registry.NodeSessionTimeout

Synopsis

`IceGrid.Registry.NodeSessionTimeout=num`

Description

Each IceGrid node establishes a session with the registry that must be refreshed periodically. If a node does not refresh its session within *num* seconds, the node's session is destroyed and the servers deployed on that node become unavailable to new clients. If not specified, the default value is 30 seconds.

IceGrid.Registry.ReplicaSessionTimeout

Synopsis

`IceGrid.Registry.ReplicaSessionTimeout=num`

Description

Each IceGrid registry replica establishes a session with the master registry that must be refreshed periodically. If a replica does not refresh its session within *num* seconds, the replica's session is destroyed and the replica doesn't receive anymore replication information from the master registry. If not specified, the default value is 30 seconds.

IceGrid.Registry.PermissionsVerifier**Synopsis**

IceGrid.Registry.PermissionsVerifier=*proxy*

Description

Specifies the proxy of an object that implements the `Glacier2::PermissionsVerifier` interface. The IceGrid registry invokes this proxy to validate each new client session created by a client with the `IceGrid::Registry` interface.

IceGrid.Registry.Server.Endpoints**Synopsis**

IceGrid.Registry.Server.Endpoints=*endpoints*

Description

Defines the endpoints of the IceGrid server interface. The server endpoints must be accessible to Ice servers that use IceGrid to register their object adapter endpoints. This property must be defined.

IceGrid.Registry.Server.PublishedEndpoints**Synopsis**

IceGrid.Registry.Server.PublishedEndpoints=*endpoints*

Description

Defines the published endpoints of the IceGrid server interface. The server endpoints must be accessible to Ice servers that use IceGrid to register their object adapter endpoints. Refer to the description of the object adapter property *adapter.PublishedEndpoints* for more information.

IceGrid.Registry.Server.ThreadPool.Size**Synopsis**

`IceGrid.Registry.Server.ThreadPool.Size=num`

Description

Defines the value of the property *adapter.ThreadPool.Size* for the object adapter named `IceGrid.Registry.Server`.

IceGrid.Registry.Server.ThreadPool.SizeMax**Synopsis**

`IceGrid.Registry.Server.ThreadPool.SizeMax=num`

Description

Defines the value of the property *adapter.ThreadPool.SizeMax* for the object adapter named `IceGrid.Registry.Server`.

IceGrid.Registry.Server.ThreadPool.SizeWarn**Synopsis**

`IceGrid.Registry.Server.ThreadPool.SizeWarn=num`

Description

Defines the value of the property *adapter.ThreadPool.SizeWarn* for the object adapter named `IceGrid.Registry.Server`.

IceGrid.Registry.SessionTimeout

Synopsis

IceGrid.Registry.SessionTimeout=*num*

Description

IceGrid clients or administrative clients might establish a session with the registry. This session must be refreshed periodically. If the client does not refresh its session within *num* seconds, the session is destroyed. If not specified, the default value is 30 seconds.

IceGrid.Registry.SSLPermissionsVerifier

Synopsis

IceGrid.Registry.SSLPermissionsVerifier=*proxy*

Description

Specifies the proxy of an object that implements the `Glacier2::SSLPermissionsVerifier` interface. The IceGrid registry invokes this proxy to validate each new client session created by a client from a secure connection with the `IceGrid::Registry` interface.

IceGrid.Registry.Trace.Adapter

Synopsis

IceGrid.Registry.Trace.Adapter=*num*

Description

The object adapter trace level:

0	No object adapter trace (default).
1	Trace object adapter registration, removal, and replication.

IceGrid.Registry.Trace.Application

Synopsis

IceGrid.Registry.Trace.Adapter=*num*

Description

The application trace level:

0	No application trace (default).
1	Trace application addition, update and removal.

IceGrid.Registry.Trace.Locator

Synopsis

IceGrid.Registry.Trace.Locator=*num*

Description

The locator and locator registry trace level:

0	No locator trace (default).
1	Trace failures to locate an adapter or object, and failures to register adapter endpoints.
2	Like 1, but more verbose, including registration of adapter endpoints.

IceGrid.Registry.Trace.Node

Synopsis

IceGrid.Registry.Trace.Node=*num*

Description

The node trace level:

0	No node trace (default).
1	Trace node registration, removal.
2	Like 1, but more verbose, including load statistics.

IceGrid.Registry.Trace.Object**Synopsis**

`IceGrid.Registry.Trace.Object=num`

Description

The object trace level:

0	No object trace (default).
1	Trace object registration, removal.

IceGrid.Registry.Trace.Patch**Synopsis**

`IceGrid.Registry.Trace.Patch=num`

Description

The patch trace level:

0	No patching trace (default).
1	Show summary of patch progress.

IceGrid.Registry.Trace.Server

Synopsis

IceGrid.Registry.Trace.Server=*num*

Description

The server trace level:

0	No server trace (default).
1	Trace server registration, removal.

IceGrid.Registry.Trace.Session

Synopsis

IceGrid.Registry.Trace.Session=*num*

Description

The session trace level:

0	No client or admin session trace (default).
1	Trace client or admin session registration, removal.
2	Like 1, but more verbose, includes keep alive messages.

IceGrid.Registry.UserAccounts

Synopsis

IceGrid.Registry.UserAccounts=*file*

Description

Specifies the file name of an IceGrid registry user account map file. Each line of the file must contain an identifier and a user account, separated by white space. The identifier will be matched against the client session identifier (the user id for sessions created with a user name and password, or the distinguished name for

sessions created from a secure connection). This user account map file is used by IceGrid nodes to map session identifiers to user accounts if the nodes' `IceGrid.Node.UserAccountMapper` property is set to the proxy `IceGrid/RegistryUserAccountMapper`.

IceGrid.Node.CollocateRegistry

Synopsis

`IceGrid.Node.CollocateRegistry=num`

Description

If *num* is set to a value larger than zero, the node collocates the IceGrid registry. The collocated registry is configured with the same properties as the standalone IceGrid registry.

IceGrid.Node.Data

Synopsis

`IceGrid.Node.Data=path`

Description

Defines the path of the IceGrid node data directory. The node creates `distrib`, `servers`, and `tmp` subdirectories in this directory if they do not already exist. The `distrib` directory contains distribution files downloaded by the node from an IcePatch2 server. The `servers` directory contains configuration data for each deployed server. The `tmp` directory holds temporary files.

IceGrid.Node.DisableOnFailure

Synopsis

`IceGrid.Node.DisableOnFailure=num`

Description

The node considers a server to have terminated improperly if it has a non-zero exit code or if it exits due to one of the signals `SIGABRT`, `SIGBUS`, `SIGILL`,

SIGFPE, or SIGSEGV. The node marks such a server as disabled if *num* is a non-zero value; a disabled server cannot be activated on demand. For values of *num* greater than zero, the server is disabled for *num* seconds. If *num* is a negative value, the server is disabled indefinitely, or until it is explicitly enabled or started via an administrative action. The default value is zero, meaning the node does not disable servers in this situation.

IceGrid.Node.Endpoints

Synopsis

IceGrid.Node.Endpoints=*endpoints*

Description

Defines the endpoints of the IceGrid node interface. The node endpoints must be accessible to the IceGrid registry. The registry uses this interface to communicate with the node.

IceGrid.Node.PublishedEndpoints

Synopsis

IceGrid.Node.PublishedEndpoints=*endpoints*

Description

Defines the published endpoints of the IceGrid node interface. The node endpoints must be accessible to the IceGrid registry. The registry uses this interface to communicate with the node. Refer to the description of the object adapter property *adapter.PublishedEndpoints* for more information.

IceGrid.Node.Name

Synopsis

IceGrid.Node.Name=*name*

Description

Defines the *name* of the IceGrid node. All nodes using the same registry must have unique names; a node refuses to start if there is a node with the same name running already.

The default value is the host name as returned by `gethostname`.

IceGrid.Node.Output**Synopsis**

`IceGrid.Node.Output=`*path*

Description

Defines the path of the IceGrid node output directory. If set, the node redirects the `stdout` and `stderr` output of the started servers to files named `server.out` and `server.err` in this directory. Otherwise, the started servers share the `stdout` and `stderr` of the node's process.

IceGrid.Node.PrintServersReady**Synopsis**

`IceGrid.Node.PrintServersReady=`*token*

Description

The IceGrid node prints "*token* ready" on standard output after all the servers managed by the node are ready. This is useful for scripts that wish to wait until all servers have been started and are ready for use.

IceGrid.Node.PropertiesOverride**Synopsis**

`IceGrid.Node.PropertiesOverride=`*overrides*

Description

Defines a list of properties that override the properties defined in server deployment descriptors. For example, in some cases it is desirable to set the property

`Ice.Default.Host` for servers, but not in server deployment descriptors. The property definitions must be separated by white space.

IceGrid.Node.RedirectErrToOut

Synopsis

`IceGrid.Node.RedirectErrToOut=num`

Description

If *num* is set to a value larger than zero, the `stderr` of each started server is redirected to the server's `stdout`.

IceGrid.Node.UserAccountMapper

Synopsis

`IceGrid.Node.UserAccountMapper=proxy`

Description

Specifies the proxy of an object that implements the `IceGrid::UserAccountMapper` interface. The IceGrid node invokes this proxy to map session identifiers (the user id for sessions created with a user name and password, or the distinguished name for sessions created from a secure connection) to user accounts.

IceGrid.Node.UserAccounts

Synopsis

`IceGrid.Node.UserAccounts=file`

Description

Specifies the file name of an IceGrid node user account map file. Each line of the file must contain an identifier and a user account, separated by white space. The identifier will be matched against the client session identifier (the user id for sessions created with a user name and password, or the distinguished name for sessions created from a secure connection). This user account map file is used by

the node to map session identifiers to user accounts. This property is ignored if `IceGrid.Node.UserAccountMapper` is defined.

IceGrid.Node.WaitTime

Synopsis

`IceGrid.Node.WaitTime=num`

Description

Defines the interval in seconds that IceGrid waits for server activation and deactivation.

If a server is automatically activated and does not register its object adapter endpoints within this time interval, the node assumes there is a problem with the server and return an empty set of endpoints to the client.

If a server is being gracefully deactivated and IceGrid does not detect the server deactivation during this time interval, IceGrid kills the server. The default value is 60 seconds.

IceGrid.Node.ThreadPool.Size

Synopsis

`IceGrid.Node.ThreadPool.Size=num`

Description

Defines the value of the property `adapter.ThreadPool.Size` for the object adapter named `IceGrid.Node`.

IceGrid.Node.ThreadPool.SizeMax

Synopsis

`IceGrid.Node.ThreadPool.SizeMax=num`

Description

Defines the value of the property `adapter.ThreadPool.SizeMax` for the object adapter named `IceGrid.Node`.

IceGrid.Node.ThreadPool.SizeWarn

Synopsis

IceGrid.Node.ThreadPool.SizeWarn=*num*

Description

Defines the value of the property *adapter.ThreadPool.SizeWarn* for the object adapter named IceGrid.Node.

IceGrid.Node.Trace.Activator

Synopsis

IceGrid.Node.Trace.Activator=*num*

Description

The activator trace level:

0	No activator trace (default).
1	Trace process activation, termination.
2	Like 1, but more verbose, including process signaling and more diagnostic messages on process activation.
3	Like 2, but more verbose, including more diagnostic messages on process activation (e.g., path, working directory, and arguments of the activated process).

IceGrid.Node.Trace.Adapter

Synopsis

IceGrid.Node.Trace.Adapter=*num*

Description

The object adapter trace level:

0	No object adapter trace (default).
1	Trace object adapter addition, removal.
2	Like 1, but more verbose, including object adapter activation and deactivation and more diagnostic messages.
3	Like 2, but more verbose, including object adapter transitional state change (e.g., 'waiting for activation').

IceGrid.Node.Trace.Patch**Synopsis**

`IceGrid.Node.Trace.Patch=num`

Description

The patch trace level:

0	No patching trace (default).
1	Show summary of patch progress.
2	Like 1, but more verbose, including download statistics.
3	Like 2, but more verbose, including checksum information.

IceGrid.Node.Trace.Server**Synopsis**

`IceGrid.Node.Trace.Server=num`

Description

The server trace level:

0	No server trace (default).
1	Trace server addition, removal.
2	Like 1, but more verbose, including server activation and deactivation and more diagnostic messages.
3	Like 2, but more verbose, including server transitional state change (activating and deactivating).

C.11 IceStorm Properties

IceStorm.InstanceName**Synopsis**

`IceStorm.InstanceName=name`

Description

Specifies an alternate identity category for the IceStorm topic manager object. If defined, the identity of the object becomes *name/TopicManager*. If not specified, the default identity category is IceStorm.

IceStorm.TopicManager.AdapterId**Synopsis**

`IceStorm.TopicManager.AdapterId=id`

Description

Defines the value of the property *adapter.AdapterId* for the object adapter named IceStorm.TopicManager.

IceStorm.TopicManager.ReplicaGroupId

Synopsis

`IceStorm.TopicManager.ReplicaGroupId=id`

Description

Defines the value of the property `adapter.ReplicaGroupId` for the object adapter named `IceStorm.TopicManager`.

IceStorm.TopicManager.Endpoints

Synopsis

`IceStorm.TopicManager.Endpoints=endpoints`

Description

Defines the endpoints for the IceStorm topic manager and topic objects.

IceStorm.TopicManager.PublishedEndpoints

Synopsis

`IceStorm.TopicManager.PublishedEndpoints=endpoints`

Description

Defines the published endpoints for the IceStorm topic manager and topic objects. Refer to the description of the object adapter property `adapter.PublishedEndpoints` for more information.

IceStorm.TopicManager.RegisterProcess

Synopsis

`IceStorm.TopicManager.RegisterProcess=num`

Description

Defines the value of the property `adapter.RegisterProcess` for the object adapter named `IceStorm.TopicManager`.

IceStorm.TopicManager.ThreadPool.Size

Synopsis

`IceStorm.TopicManager.ThreadPool.Size=num`

Description

Defines the value of the property `adapter.ThreadPool.Size` for the object adapter named `IceStorm.TopicManager`.

IceStorm.TopicManager.ThreadPool.SizeMax

Synopsis

`IceStorm.TopicManager.ThreadPool.SizeMax=num`

Description

Defines the value of the property `adapter.ThreadPool.SizeMax` for the object adapter named `IceStorm.TopicManager`.

IceStorm.TopicManager.ThreadPool.SizeWarn

Synopsis

`IceStorm.TopicManager.ThreadPool.SizeWarn=num`

Description

Defines the value of the property `adapter.ThreadPool.SizeWarn` for the object adapter named `IceStorm.TopicManager`.

IceStorm.Publish.AdapterId

Synopsis

`IceStorm.Publish.AdapterId=id`

Description

Defines the value of the property `adapter.AdapterId` for the object adapter named `IceStorm.Publish`.

IceStorm.Publish.ReplicaGroupId

Synopsis

IceStorm.Publish.ReplicaGroupId=*id*

Description

Defines the value of the property *adapter.ReplicaGroupId* for the object adapter named IceStorm.Publish.

IceStorm.Publish.Endpoints

Synopsis

IceStorm.Publish.Endpoints=*endpoints*

Description

Defines the endpoints for the IceStorm publisher objects.

IceStorm.Publish.PublishedEndpoints

Synopsis

IceStorm.Publish.PublishedEndpoints=*endpoints*

Description

Defines the published endpoints for the IceStorm publisher objects. Refer to the description of the object adapter property *adapter.PublishedEndpoints* for more information.

IceStorm.Publish.RegisterProcess

Synopsis

IceStorm.Publish.RegisterProcess=*num*

Description

Defines the value of the property *adapter.RegisterProcess* for the object adapter named IceStorm.Publish.

IceStorm.Publish.ThreadPool.Size

Synopsis

`IceStorm.Publish.ThreadPool.Size=num`

Description

Defines the value of the property `adapter.ThreadPool.Size` for the object adapter named `IceStorm.Publish`.

IceStorm.Publish.ThreadPool.SizeMax

Synopsis

`IceStorm.Publish.ThreadPool.SizeMax=num`

Description

Defines the value of the property `adapter.ThreadPool.SizeMax` for the object adapter named `IceStorm.Publish`.

IceStorm.Publish.ThreadPool.SizeWarn

Synopsis

`IceStorm.Publish.ThreadPool.SizeWarn=num`

Description

Defines the value of the property `adapter.ThreadPool.SizeWarn` for the object adapter named `IceStorm.Publish`.

IceStorm.Trace.TopicManager

Synopsis

`IceStorm.Trace.TopicManager=num`

Description

The topic manager trace level:

0	No topic manager trace (default).
1	Trace topic creation.

IceStorm.Trace.Topic**Synopsis**

`IceStorm.Trace.Topic=num`

Description

The topic trace level:

0	No topic trace (default).
1	Trace topic links, subscription, and unsubscription.
2	Like 1, but more verbose, including QoS information, and other diagnostic information.

IceStorm.Trace.Flush**Synopsis**

`IceStorm.Trace.Flush=num`

Description

Trace information on the thread that flushes batch reliability events to subscribers:

0	No flush trace (default).
1	Trace each flush.

IceStorm.Trace.Subscriber

Synopsis

IceStorm.Trace.Subscriber=*num*

Description

The subscriber trace level:

0	No subscriber trace (default).
1	Trace topic diagnostic information on subscription and unsubscription.

IceStorm.Flush.Timeout

Synopsis

IceStorm.Flush.Timeout=*num*

Description

Defines the interval in milliseconds with which batch reliability events are sent to subscribers. The default is 1000ms. The minimum value of this property is 100ms.

IceStorm.TopicManager.Proxy

Synopsis

IceStorm.TopicManager.Proxy=*proxy*

Description

Defines the proxy for the IceStorm topic manager. This property is used by the IceStorm administration tool, and may also be used by applications.

C.12 Glacier2 Properties

Glacier2.AddUserToAllowCategories

Synopsis

`Glacier2.AddUserToAllowCategories=num`

Description

Specifies whether to add an authenticated user id to the `Glacier2.AllowCategories` property when creating of a new session. The legal values are shown below:

0	Do not add the user id (default).
1	Add the user id.
2	Add the user id with a leading underscore.

Glacier2.Admin.Endpoints

Synopsis

`Glacier2.Admin.Endpoints=endpoints`

Description

Defines the optional administrative endpoints of the Glacier2 admin interface. The administrative endpoints must be accessible to clients that use the Glacier2 admin interface.

Allowing access to the Glacier2 admin interface is a security risk! If this property is not defined, the admin interface is disabled.

Glacier2.Admin.PublishedEndpoints

Synopsis

`Glacier2.Admin.PublishedEndpoints=endpoints`

Description

Defines the optional administrative published endpoints of the Glacier2 admin interface. The administrative endpoints must be accessible to clients that are using the Glacier2 administrative interface. Refer to the description of the object adapter property `adapter.PublishedEndpoints` for more information.

Allowing access to the Glacier2 admin interface is a security risk!

Glacier2.AllowCategories**Synopsis**

`Glacier2.AllowCategories=list`

Description

Specifies a white space-separated list of identity categories. If this property is defined, then the Glacier2 router only allows requests to Ice objects with an identity that matches one of the categories from this list. If

`Glacier2.AddUserToAllowCategories` is defined with a non-zero value, the router automatically adds the user id of each session to this list.

This property is deprecated and supported only for backward-compatibility. New applications should use `Glacier2.Filter.Category.Accept`.

Glacier2.Client.AlwaysBatch**Synopsis**

`Glacier2.Client.AlwaysBatch=num`

Description

If `num` is set to a value larger than zero, the Glacier2 router always batches queued oneway requests from clients to servers regardless of the value of their `_fwd` contexts. This property is only relevant when `Glacier2.Client.Buffered=1`. The default value is 0.

Glacier2.Client.Endpoints**Synopsis**

`Glacier2.Client.Endpoints=endpoints`

Description

Defines the client endpoints of the Glacier2 router. These endpoints must be accessible to router clients. Use of a secure transport is highly recommended.

Glacier2.Client.PublishedEndpoints**Synopsis**

`Glacier2.Client.PublishedEndpoints=endpoints`

Description

Defines the published client endpoints of the Glacier2 router. These endpoints must be accessible to router clients. Use of a secure transport is highly recommended. Refer to the description of the object adapter property `adapter.PublishedEndpoints` for more information.

Glacier2.Client.ForwardContext**Synopsis**

`Glacier2.Client.ForwardContext=num`

Description

If *num* is set to a value larger than zero, the Glacier2 router includes the context in forwarded requests from clients to servers. The default value is 0.

Glacier2.Client.SleepTime**Synopsis**

`Glacier2.Client.SleepTime=num`

Description

If *num* is set to a value larger than zero, the Glacier2 router sleeps for the specified number of milliseconds after forwarding all queued requests from a client. This prevents the client from flooding the router with requests. This property is only relevant when `Glacier2.Client.Buffered=1`. The default value is 0.

Glacier2.Client.Trace.Override

Synopsis

`Glacier2.Client.Trace.Override=num`

Description

If *num* is set to a value larger than zero, the Glacier2 router logs a trace message whenever a request was overridden. The default value is 0.

Glacier2.Client.Trace.Reject

Synopsis

`Glacier2.Client.Trace.Reject=num`

Description

If *num* is set to a value larger than zero, the Glacier2 router logs a trace message whenever the router's configured filters reject a client's request. The default value is 0.

Glacier2.Client.Trace.Request

Synopsis

`Glacier2.Client.Trace.Request=num`

Description

If *num* is set to a value larger than zero, the Glacier2 router logs a trace message for each request that is forwarded from a client. The default value is 0.

Glacier2.Client.Buffered

Synopsis

`Glacier2.Client.Buffered=num`

Description

If *num* is set to a value larger than zero, the Glacier2 router queues incoming requests from clients and creates an extra thread for each client connection that

processes the queued requests. If *num* is set to zero, the router operates in unbuffered mode in which a request is forwarded in the same thread that received it. The default value is 1.

In unbuffered mode, twoway requests from a client are serialized, and nested twoway requests are not supported.

Glacier2.CryptPasswords

Synopsis

`Glacier2.CryptPasswords=file`

Description

Specifies the file name of a Glacier2 access control list. Each line of the file must contain a user name and a password, separated by white space. The password must be a 13-character crypt-encoded string. This property is ignored if `Glacier2.PermissionsVerifier` is defined.

Glacier2.Filter.AdapterId.Accept

Synopsis

`Glacier2.Filter.AdapterId.Accept=string`

Description

Specifies a space-separated list of adapter identifiers. If defined, the Glacier2 router only allows requests to Ice objects with an adapter identifier that matches one of the entries in this list.

Identifiers that contain spaces must be enclosed in single or double quotes. Single or double quotes that appear within an identifier must be escaped with a leading backslash.

Glacier2.Filter.Address.Accept

Synopsis

`Glacier2.Filter.Address.Accept=string`

Description

Specifies a space-separated list of address-port pairs. When defined, the Glacier2 router only allows requests to Ice objects through proxies that contain network endpoint information that matches an address-port pair listed in this property. If not defined, the default value is *, which indicates that any network address is permitted. Requests accepted by this property may be rejected by the `Glacier2.Filter.Address.Reject` property.

Each pair is of the form *address:port*. The *address* or *port* number portion can include wildcards ('*') or value ranges or groups. Ranges and groups are in the form [*value1*, *value2*, *value3*, ...] and/or [*value1-value2*]. Wildcards, ranges, and groups may appear anywhere in the address-port pair string.

Glacier2.Filter.Address.Reject**Synopsis**

`Glacier2.Filter.Address.Reject=string`

Description

Specifies a space-separated list of address-port pairs. When defined, the Glacier2 router rejects requests to Ice objects through proxies that contain network endpoint information that matches an address-port pair listed in this property. If not set, the Glacier2 router allows requests to any network address unless the `Glacier2.Filter.Address.Accept` property is set, in which case requests will be accepted or rejected based on the `Glacier2.Filter.Address.Accept` property. If both the `Glacier2.Filter.Address.Accept` and `Glacier2.Filter.Address.Reject` properties are defined, the `Glacier2.Filter.Address.Reject` property takes precedence.

Each pair is of the form *address:port*. The *address* or *port* number portion can include wildcards ('*') or value ranges or groups. Ranges and groups are in the form of [*value1*, *value2*, *value3*, ...] and/or [*value1-value2*]. Wildcards, ranges, and groups may appear anywhere in the address-port pair string.

Glacier2.Filter.Category.Accept**Synopsis**

`Glacier2.Filter.Category.Accept=string`

Description

Specifies a space-separated list of identity categories. If defined, the Glacier2 router only allows requests to Ice objects with an identity that matches one of the categories in this list. If `Glacier2.AddUserToAllowCategories` is defined with a non-zero value, the router automatically adds the user name of each session to this list.

Categories that contain spaces must be enclosed in single or double quotes. Single or double quotes that appear within a category must be escaped with a leading backslash.

Glacier2.Filter.Identity.Accept**Synopsis**

`Glacier2.Filter.Identity.Accept=string`

Description

Specifies a space-separated list of identities. If defined, the Glacier2 router only allows requests to Ice objects with an identity that matches one of the entries in this list.

Identities that contain spaces must be enclosed in single or double quotes. Single or double quotes that appear within an identity must be escaped with a leading backslash.

Glacier2.Filter.ProxySizeMax**Synopsis**

`Glacier2.Filter.ProxySizeMax=num`

Description

If set, the Glacier2 router rejects requests whose stringified proxies are longer than *num*. This helps secure the system against attack. If unset, Glacier2 will accept requests using proxies of any length.

Glacier2.InstanceName

Synopsis

Glacier2.InstanceName=*name*

Description

Specifies a default identity category for the Glacier2 objects. If defined, the identity of the Glacier2 admin interface becomes *name/admin* and the identity of the Glacier2 router interface becomes *name/router*.

If not defined, the default value is Glacier2.

Glacier2.PermissionsVerifier

Synopsis

Glacier2.PermissionsVerifier=*proxy*

Description

Specifies the proxy of an object that implements the Glacier2::PermissionsVerifier interface. The router invokes this proxy to validate the user name and password of each new session. Sessions created from a secure connection are verified by the object specified in Glacier2.SSLPermissionsVerifier. For simple configurations, you can specify the name of a password file using Glacier2.CryptPasswords.

Glacier2.RoutingTable.MaxSize

Synopsis

Glacier2.RoutingTable.MaxSize=*num*

Description

This property sets the size of the router's routing table to *num* entries. If more proxies are added to the table than this value, proxies are evicted from the table on a least-recently used basis.

Clients based on Ice version 3.1 and later automatically retry operation calls on evicted proxies and transparently re-add such proxies to the table. Clients based on Ice versions earlier than 3.1 receive an ObjectNotExistException for

invocations on evicted proxies. For such older clients, *num* must be set to a sufficiently large value to prevent these clients from failing.

The default size of the routing table is 1000.

Glacier2.Server.AlwaysBatch

Synopsis

`Glacier2.Server.AlwaysBatch=num`

Description

If *num* is set to a value larger than zero, the Glacier2 router always batches queued oneway requests from servers to clients regardless of the value of their `_fwd` contexts. This property is only relevant when `Glacier2.Server.Buffered=1`. The default value is 0.

Glacier2.Server.Endpoints

Synopsis

`Glacier2.Server.Endpoints=endpoints`

Description

Defines the server endpoints of the Glacier2 router. These endpoints must be accessible to back end servers.

Glacier2.Server.PublishedEndpoints

Synopsis

`Glacier2.Server.PublishedEndpoints=endpoints`

Description

Defines the published server endpoints of the Glacier2 router. These endpoints must be accessible to back end servers. Refer to the description of the object adapter property `adapter.PublishedEndpoints` for more information.

Glacier2.Server.ForwardContext

Synopsis

`Glacier2.Server.ForwardContext=num`

Description

If *num* is set to a value larger than zero, the Glacier2 router includes the context in forwarded requests from servers to clients. The default value is 0.

Glacier2.Server.SleepTime

Synopsis

`Glacier2.Server.SleepTime=num`

Description

If *num* is set to a value larger than zero, the Glacier2 router sleeps for the specified number of milliseconds after forwarding all queued requests from a server. This prevents the server from flooding the router with requests. This property is only relevant when `Glacier2.Server.Buffered=1`. The default value is 0.

Glacier2.Server.Trace.Override

Synopsis

`Glacier2.Server.Trace.Override=num`

Description

If *num* is set to a value larger than zero, the Glacier2 router logs a trace message whenever a request is overridden. The default value is 0.

Glacier2.Server.Trace.Request

Synopsis

`Glacier2.Server.Trace.Request=num`

Description

If *num* is set to a value larger than zero, the Glacier2 router logs a trace message for each request that is forwarded from a server. The default value is 0.

Glacier2.Server.Buffered**Synopsis**

`Glacier2.Server.Buffered=num`

Description

If *num* is set to a value larger than zero, the Glacier2 router queues incoming requests from servers and creates an extra thread for each server's connection that processes the queued requests. If *num* is set to zero, the router operates in unbuffered mode, in which a request is forwarded in the same thread that received it. The default value is 1.

In unbuffered mode, twoway requests from a server are serialized, and nested twoway requests are not supported.

Unbuffered mode for server requests is susceptible to a denial-of-service attack from hostile clients. Use caution!

Glacier2.SessionManager**Synopsis**

`Glacier2.SessionManager=proxy`

Description

Specifies the proxy of an object that implements the `Glacier2::SessionManager` interface. The router invokes this proxy to create a new session for a client, but only after the router validates the client's user name and password.

Glacier2.SSLSessionManager**Synopsis**

`Glacier2.SSLSessionManager=proxy`

Description

Specifies the proxy of an object that implements the `Glacier2::SSLSessionManager` interface. The router invokes this proxy to create a new session for a client that has called `createSessionFromSecureConnection`.

Glacier2.SSLPermissionsVerifier**Synopsis**

`Glacier2.SSLPermissionsVerifier=proxy`

Description

Specifies the proxy of an object that implements the `Glacier2::SSLPermissionsVerifier` interface. The router invokes this proxy to verify the credentials of clients that attempt to create a session from a secure connection. Sessions created with a user name and password are verified by the object specified in `Glacier2.PermissionsVerifier`.

Glacier2.SessionTimeout**Synopsis**

`Glacier2.SessionTimeout=num`

Description

If *num* is set to a value larger than zero, a client's session with the Glacier2 router expires after the specified *num* seconds of inactivity. The default value is 0, meaning sessions do not expire due to inactivity.

It is important to choose *num* such that client sessions do not expire prematurely.

Glacier2.Trace.RoutingTable**Synopsis**

`Glacier2.Trace.RoutingTable=num`

Description

The routing table trace level:

0	No routing table trace (default).
1	Logs a message for each proxy that is added to the routing table.
2	Logs a message for each proxy that is evicted from the routing table (see <code>Glacier2.RoutingTable.MaxSize</code>).
3	Combines the output for trace levels 1 and 2.

Glacier2.Trace.Session**Synopsis**

`Glacier2.Trace.Session=num`

Description

If *num* is set to a value larger than zero, the Glacier2 router logs trace messages about session-related activities. The default value is 0.

C.13 Freeze Properties**Freeze.DbEnv.*env-name*.CheckpointPeriod****Synopsis**

`Freeze.DbEnv.env-name.CheckpointPeriod=num`

Description

Every Berkeley DB environment created by Freeze has an associated thread that checkpoints this environment every *num* seconds. If *num* is less than 0, no checkpoint is performed. The default is 120 seconds.

Freeze.DbEnv.env-name.DbHome

Synopsis

Freeze.DbEnv.*env-name*.DbHome=*db-home*

Description

Defines the home directory of this Freeze database environment. The default is *env-name*.

Freeze.DbEnv.env-name.DbPrivate

Synopsis

Freeze.DbEnv.*env-name*.DbPrivate=*num*

Description

If *num* is set to a value larger than zero, Freeze instructs Berkeley DB to use process-private memory instead of shared memory. The default value is 1. Set this property to 0 in order to run **db_archive** (or another Berkeley DB utility) on a running environment.

Freeze.DbEnv.env-name.DbRecoverFatal

Synopsis

Freeze.DbEnv.*env-name*.DbRecoverFatal=*num*

Description

If *num* is set to a value larger than zero, fatal recovery is performed when the environment is opened. The default value is 0.

Freeze.DbEnv.env-name.OldLogsAutoDelete

Synopsis

Freeze.DbEnv.*env-name*.OldLogsAutoDelete=*num*

Description

If *num* is set to a value larger than zero, old transactional logs no longer in use are deleted after each periodic checkpoint (see `Freeze.DbEnv.env-name.CheckpointPeriod`). The default value is 1.

Freeze.DbEnv.env-name.PeriodicCheckpointMinSize**Synopsis**

`Freeze.DbEnv.env-name.PeriodicCheckpointMinSize=num`

Description

num is the minimum size in kbytes for the periodic checkpoint (see `Freeze.DbEnv.env-name.CheckpointPeriod`). This value is passed to Berkeley DB's `checkpoint` function. The default is 0 (which means no minimum).

Freeze.Evictor.env-name.filename.MaxTxSize**Synopsis**

`Freeze.Evictor.env-name.filename.MaxTxSize=num`

Description

Freeze uses a background thread to save updates to the database. Transactions are used to save many facets together. *num* defines the maximum number of facets saved per transaction. The default is `10 * SaveSizeTrigger` (see `Freeze.Evictor.env-name.filename.SaveSizeTrigger`); if this value is negative, the actual value is set to 100.

Freeze.Evictor.env-name.filename.PopulateEmptyIndices**Synopsis**

`Freeze.Evictor.env-name.filename.PopulateEmptyIndices=num`

Description

When *num* is not 0 and you create an evictor with one or more empty indexes, the `createEvictor` call will populate these indexes by iterating over all the corresponding facets. This is particularly useful after transforming a Freeze evictor with `FreezeScript`, since `FreezeScript` does not transform indexes; however this can significantly slow down `createEvictor` if you have an empty index because none of the facets currently in your database match the type of this index. The default value for this property is 0.

Freeze.Evictor.*env-name*.filename.SavePeriod

Synopsis

```
Freeze.Evictor.env-name.filename.SavePeriod=num
```

Description

Freeze uses a background thread to save updates to the database. After *num* milliseconds without saving, if any facet is created, modified, or destroyed, this background thread wakes up to save these facets. When *num* is 0, there is no periodic saving. The default is 60000.

Freeze.Evictor.*env-name*.filename.SaveSizeTrigger

Synopsis

```
Freeze.Evictor.env-name.filename.SaveSizeTrigger=num
```

Description

Freeze uses a background thread to save updates to the database. When *num* is 0 or positive, as soon as *num* or more facets have been created, modified, or destroyed, this background thread wakes up to save them. When *num* is negative, there is no size trigger. The default is 10.

Freeze.Evictor.*env-name*.filename.StreamTimeout

Synopsis

```
Freeze.Evictor.env-name.filename.StreamTimeout=num
```

Description

When the saving thread saves an object, it needs to lock this object in order to get a consistent copy of the object's state. If the lock cannot be acquired within *num* seconds, a fatal error is generated. If a fatal error callback was registered by the application, this callback is called; otherwise the program is terminated immediately. When *num* is 0 or negative, there is no timeout. The default value is 0.

Freeze.Trace.DbEnv**Synopsis**

`Freeze.Trace.DbEnv=num`

Description

The Freeze database environment activity trace level:

0	No database environment activity trace (default).
1	Trace database open and close.
2	Also trace checkpoints and the removal of old log files.

Freeze.Trace.Evictor**Synopsis**

`Freeze.Trace.Evictor=num`

Description

The Freeze evictor activity trace level:

0	No evictor activity trace (default).
1	Trace Ice object and facet creation and destruction, facet streaming time, facet saving time, object eviction (every 50 objects) and evictor deactivation.
2	Also trace object lookups, and all object evictions.

3	Also trace object retrieval from the database.
---	--

Freeze.Trace.Map

Synopsis

`Freeze.Trace.Map=num`

Description

The Freeze map activity trace level:

0	No map activity trace (default).
1	Trace database open and close.
2	Also trace iterator and transaction operations, and reference counting of the underlying database.

Freeze.Warn.Deadlocks

Synopsis

`Freeze.Warn.Deadlocks=num`

Description

If *num* is set to a value larger than zero, Freeze logs a warning message when a deadlock occur. The default value is 0.

Freeze.Warn.CloseInFinalize

Synopsis

`Freeze.Warn.CloseInFinalize=num`

Description

If *num* is set to a value larger than zero, Freeze logs a warning message when an application neglects to explicitly close a map iterator. The default value is 1 (Java only).

C.14 IcePatch2 Properties

IcePatch2.Admin.Endpoints

Synopsis

`IcePatch2.Admin.Endpoints=endpoints`

Description

If this property is set, the IcePatch2 server creates an additional object of type `IcePatch2::Admin`. The shutdown operation on this interface can be used to remotely shut down the server. The endpoints specified by this property should be secured against access from potentially hostile clients.

IcePatch2.ChunkSize

Synopsis

`IcePatch2.ChunkSize=kilobytes`

Description

The IcePatch2 client uses this property to determine how many kilobytes are retrieved with each call to `getFileCompressed`.

The default value is 100.

IcePatch2.Directory

Synopsis

`IcePatch2.Directory=dir`

Description

The IcePatch2 server uses this property to determine the data directory if no data directory is specified on the command line.

This property is also read by the `IcePatch2::Patcher` utility class to determine the data directory. The property must be set before the class is instantiated.

IcePatch2.Endpoints

Synopsis

IcePatch2.Endpoints=*endpoints*

Description

Specifies the endpoints of the IcePatch2 server. This property is required by both the IcePatch2 server and client.

IcePatch2.InstanceName

Synopsis

IcePatch2.InstanceName=*name*

Description

Specifies a default identity category for the IcePatch2 objects. If defined, the identity of the IcePatch2 admin interface becomes *name/admin* and the identity of the IcePatch2 file server interface becomes *name/server*.

If not defined, the default value is IcePatch2.

IcePatch2.Remove

Synopsis

IcePatch2.Remove=*num*

Description

This property determines whether the IcePatch2 client deletes files that exist locally, but not on the server. A negative or zero value prevents removal of files. A value of 1 enables removal and causes the client to halt with an error if removal of a file fails. A value of 2 or greater also enables removal, but causes the client to silently ignore errors during removal.

This property is also read by the `IcePatch2::Patcher` utility class. The property must be set before the class is instantiated.

The default value is 1.

IcePatch2.Thorough

Synopsis

IcePatch2.Thorough=*num*

Description

This property determines whether `IcePatch2::Patcher` utility class recomputes checksums. Any value greater than zero is interpreted as true. The property must be set before the class is instantiated. The default value is 0 (false).

Appendix D

Proxies and Endpoints

D.1 Proxies

Synopsis

```
identity -f facet -t -o -O -d -D -s @ adapter_id : endpoints
```

Description

A stringified proxy consists of an identity, proxy options, and an optional object adapter identifier or endpoint list. White space (the space, tab (`\t`), line feed (`\n`), and carriage return (`\r`) characters) act as token delimiters; if a white space character appears as part of a component of a stringified proxy (such as the identity), it must be quoted or escaped as described below.

A proxy containing an identity with no endpoints, or an identity with an object adapter identifier, represents an indirect proxy that will be resolved using the Ice locator (see the `Ice.Default.Locator` property).

Proxy options configure the invocation mode:

<code>-f facet</code>	Select a facet of the Ice object.
<code>-t</code>	Configures the proxy for twoway invocations (default).
<code>-o</code>	Configures the proxy for oneway invocations.

-0	Configures the proxy for batch oneway invocations.
-d	Configures the proxy for datagram invocations.
-D	Configures the proxy for batch datagram invocations.
-s	Configures the proxy for secure invocations.

The proxy options `-t`, `-o`, `-0`, `-d`, and `-D` are mutually exclusive.

The object identity `identity` is structured as `[category/]name`, where the `category` component and slash separator are optional. If `identity` contains white space or either of the characters `:` or `@`, it must be enclosed in single or double quotes. The `category` and `name` components are UTF-8 strings that use the encoding described below. Any occurrence of a slash (`/`) in `category` or `name` must be escaped with a backslash (i.e., `\`).

The `facet` argument of the `-f` option represents a facet name. If `facet` contains white space, it must be enclosed in single or double quotes. A facet name is a UTF-8 string that uses the encoding described below.

The object adapter identifier `adapter_id` is a UTF-8 string that uses the encoding described below. If `adapter_id` contains white space, it must be enclosed in single or double quotes.

Single quotes can be used to prevent white space characters from being interpreted as delimiters, and to escape the special meaning of the backslash (`\`) character. Within single quotes, the only character that retains its special meaning is the single quote itself; a backslash can be used to prevent interpretation of a single quote as a closing quote, for example: `'a string with a \' quote'`.

Double quotes prevent interpretation of white space characters as delimiters and prevent interpretation of a single quote as an opening or closing quote. For example: `"a string with a ' quote"`. However, escape sequences such as `\b` are interpreted within double quotes.

UTF-8 strings are encoded using ASCII characters for the ordinal range 32-126 (inclusive). Characters outside this range must be encoded using escape sequences (`\b`, `\f`, `\n`, `\r`, `\t`) or octal notation (e.g., `\007`). A double quote can be escaped using a backslash, as can the backslash itself (`\\`).

If `endpoints` are specified, they must be separated with a colon (`:`) and formatted as described on page 1783. The order of endpoints in the stringified proxy is not necessarily the order in which connections are attempted during binding: when a stringified proxy is converted into a proxy instance, the endpoint list is randomized as a form of load balancing.

If the `-s` option is specified, only those endpoints that support secure invocations are considered during binding. If no valid endpoints are found, the application receives `Ice::NoEndpointException`.

Otherwise, if the `-s` option is not specified, the endpoint list is ordered so that non-secure endpoints have priority over secure endpoints during binding. In other words, connections are attempted on all non-secure endpoints before any secure endpoints are attempted.

If an unknown option is specified, or the stringified proxy is malformed, the application receives `Ice::ProxyParseException`. If an endpoint is malformed, the application receives `Ice::EndpointParseException`.

D.2 Endpoints

Synopsis

```
endpoint : endpoint
```

Description

An endpoint list comprises one or more endpoints separated by a colon (:). An endpoint has the following format:

```
protocol option
```

The supported protocols are `tcp`, `udp`, `ssl`, and `default`. If `default` is used, it is replaced by the value of the `Ice.Default.Protocol` property. If an endpoint is malformed, or an unknown protocol is specified, the application receives `Ice::EndpointParseException`.

The `ssl` protocol is only available if the `IceSSL` plug-in is installed.

The protocols and their supported options are described in the sections that follow.

TCP Endpoint

Synopsis

```
tcp -h host -p port -t timeout -z
```

Description

A `tcp` endpoint supports the following options:

Option	Description	Client Semantics	Server Semantics
<code>-h <i>host</i></code>	Specifies the host name or IP address of the endpoint. If not specified, the value of <code>Ice.Default.Host</code> is used instead.	Determines the host name or IP address to which a connection attempt is made. If not specified, all network interfaces (including loopback) are tried to contact the server.	Determines the network interface on which the object adapter listens for connections. If not specified, (or specified as <code>-h *</code> or <code>-h 0.0.0.0</code>), the adapter listens on all network interfaces (including the loopback interface). The endpoints specified by <code>-h</code> are published in proxies. If not specified, all endpoints except loopback are published (except if loopback is the only available interface, in which case only loopback is published).

<code>-p <i>port</i></code>	Specifies the port number of the endpoint.	Determines the port to which a connection attempt is made (required).	The port will be selected by the operating system if this option is not specified or port is zero.
<code>-t <i>timeout</i></code>	Specifies the endpoint timeout in milliseconds.	If timeout is greater than zero, it sets a maximum delay for binding and proxy invocations. If a timeout occurs, the application receives <code>Ice::TimeoutException</code> .	Determines the default timeout that is advertised in proxies created by the object adapter.
<code>-z</code>	Specifies bzip2 compression.	Determines whether compressed requests are sent.	Determines whether compression is advertised in proxies created by the adapter.

UDP Endpoint

Synopsis

```
udp -v major.minor -e major.minor -h host -p port -c -z
```

Description

A udp endpoint supports the following options:

Option	Description	Client Semantics	Server Semantics
<code>-v</code> <i>major.</i> <i>minor</i>	Specifies the protocol major and highest minor version number to be used for this endpoint. If not specified, the protocol major version and highest supported minor version of the client-side Ice run time is used.	Determines the protocol major version and highest minor version used by the client side when sending messages to this endpoint. The protocol major version number must match the protocol major version number of the server; the protocol minor version number must not be higher than the highest minor version number supported by the server.	Determines the protocol major version and highest minor version advertised by the server side for this endpoint. The protocol major version number must match the protocol major version number of the server; the protocol minor version number must not be higher than the highest minor version number supported by the server.

<p>-e <i>major</i>. <i>minor</i></p>	<p>Specifies the encoding major and highest minor version number to be used for this endpoint. If not specified, the encoding major version and highest supported minor version of the client-side Ice run time is used.</p>	<p>Determines the encoding major version and highest minor version used by the client side when sending messages to this endpoint. The encoding major version number must match the encoding major version number of the server; the encoding minor version number must not be higher than the highest minor version number supported by the server.</p>	<p>Determines the encoding version and highest minor version advertised by the server side for this endpoint. The protocol major version number must match the protocol major version number of the server; the protocol minor version number must not be higher than the highest minor version number supported by the server.</p>
--	--	--	---

<p><code>-h</code> <i>host</i></p>	<p>Specifies the host name or IP address of the endpoint. If not specified, the value of <code>Ice.Default.Host</code> is used instead.</p>	<p>Determines the host name or IP address to which a datagrams are sent. If not specified, all network interfaces (including loopback) are tried to contact the server.</p>	<p>Determines the network interface on which the object adapter listens for datagrams. If not specified, (or specified as <code>-h *</code> or <code>-h 0.0.0.0</code>), the adapter listens on all network interfaces (including the loopback interface). The endpoints specified by <code>-h</code> are published in proxies. If not specified, all endpoints except loopback are published (except if loopback is the only available interface, in which case only loopback is published).</p>
--	---	---	---

<code>-p</code> <i>port</i>	Specifies the port number of the endpoint.	Determines the port to which datagrams are sent (required).	The port will be selected by the operating system if this option is not specified or port is zero.
<code>-c</code>	Specifies that a connected UDP socket should be used.	None.	Causes the server to connect to the socket of the first peer that sends a datagram to this endpoint.
<code>-z</code>	Specifies bzip2 compression.	Determines whether compressed requests are sent.	Determines whether compression is advertised in proxies created by the adapter.

SSL Endpoint

Synopsis

```
ssl -h host -p port -t timeout -z
```

Description

An `ssl` endpoint supports the following options:

Option	Description	Client Semantics	Server Semantics
--------	-------------	------------------	------------------

<code>-h <i>host</i></code>	Specifies the host name or IP address of the endpoint. If not specified, the value of <code>Ice.Default.Host</code> is used instead.	Determines the host name or IP address to which a connection attempt is made. If not specified, all network interfaces (including loopback) are tried to contact the server.	Determines the network interface on which the object adapter listens for connections. If not specified, (or specified as <code>-h *</code> or <code>-h 0.0.0.0</code>), the adapter listens on all network interfaces (including the loopback interface). The endpoints specified by <code>-h</code> are published in proxies. If not specified, all endpoints except loopback are published (except if loopback is the only available interface, in which case only loopback is published).
-----------------------------	--	--	---

<code>-p</code> <i>port</i>	Specifies the port number of the endpoint.	Determines the port to which a connection attempt is made (required).	The port will be selected by the operating system if this option is not specified or port is zero.
<code>-t</code> <i>timeout</i>	Specifies the endpoint timeout in milliseconds.	If timeout is greater than zero, it sets a maximum delay for binding and proxy invocations. If a timeout occurs, the application receives <code>Ice::TimeoutException</code> .	Determines the default timeout that is advertised in proxies created by the object adapter.
<code>-z</code>	Specifies bzip2 compression.	Determines whether compressed requests are sent.	Determines whether compression is advertised in proxies created by the adapter.

Appendix E

License Information

THE WORK (AS DEFINED BELOW) IS PROVIDED UNDER THE TERMS OF THIS CREATIVE COMMONS PUBLIC LICENSE ("CCPL" OR "LICENSE"). THE WORK IS PROTECTED BY COPYRIGHT AND/OR OTHER APPLICABLE LAW. ANY USE OF THE WORK OTHER THAN AS AUTHORIZED UNDER THIS LICENSE OR COPYRIGHT LAW IS PROHIBITED.

BY EXERCISING ANY RIGHTS TO THE WORK PROVIDED HERE, YOU ACCEPT AND AGREE TO BE BOUND BY THE TERMS OF THIS LICENSE. THE LICENSOR GRANTS YOU THE RIGHTS CONTAINED HERE IN CONSIDERATION OF YOUR ACCEPTANCE OF SUCH TERMS AND CONDITIONS.

E.1 Definitions

1. "**Collective Work**" means a work, such as a periodical issue, anthology or encyclopedia, in which the Work in its entirety in unmodified form, along with a number of other contributions, constituting separate and independent works in themselves, are assembled into a collective whole. A work that constitutes a Collective Work will not be considered a Derivative Work (as defined below) for the purposes of this License.
2. "**Derivative Work**" means a work based upon the Work or upon the Work and other pre-existing works, such as a translation, musical arrangement,

dramatization, fictionalization, motion picture version, sound recording, art reproduction, abridgment, condensation, or any other form in which the Work may be recast, transformed, or adapted, except that a work that constitutes a Collective Work will not be considered a Derivative Work for the purpose of this License. For the avoidance of doubt, where the Work is a musical composition or sound recording, the synchronization of the Work in timed-relation with a moving image ("synching") will be considered a Derivative Work for the purpose of this License.

3. **"Licensor"** means the individual or entity that offers the Work under the terms of this License.
4. **"Original Author"** means the individual or entity who created the Work.
5. **"Work"** means the copyrightable work of authorship offered under the terms of this License.
6. **"You"** means an individual or entity exercising rights under this License who has not previously violated the terms of this License with respect to the Work, or who has received express permission from the Licensor to exercise rights under this License despite a previous violation.

E.2 Fair Use Rights

Nothing in this License is intended to reduce, limit, or restrict any rights arising from fair use, first sale or other limitations on the exclusive rights of the copyright owner under copyright law or other applicable laws.

E.3 License Grant

Subject to the terms and conditions of this License, Licensor hereby grants You a worldwide, royalty-free, non-exclusive, perpetual (for the duration of the applicable copyright) license to exercise the rights in the Work as stated below:

1. to reproduce the Work, to incorporate the Work into one or more Collective Works, and to reproduce the Work as incorporated in the Collective Works;
2. to distribute copies or phonorecords of, display publicly, perform publicly, and perform publicly by means of a digital audio transmission the Work including as incorporated in Collective Works.

3. For the avoidance of doubt, where the Work is a musical composition:

1. Performance Royalties Under Blanket Licenses

Licensor waives the exclusive right to collect, whether individually or via a performance rights society (e.g. ASCAP, BMI, SESAC), royalties for the public performance or public digital performance (e.g. webcast) of the Work.

2. Mechanical Rights and Statutory Royalties

Licensor waives the exclusive right to collect, whether individually or via a music rights society or designated agent (e.g. Harry Fox Agency), royalties for any phonorecord You create from the Work ("cover version") and distribute, subject to the compulsory license created by 17 USC Section 115 of the US Copyright Act (or the equivalent in other jurisdictions).

4. Webcasting Rights and Statutory Royalties

For the avoidance of doubt, where the Work is a sound recording, Licensor waives the exclusive right to collect, whether individually or via a performance-rights society (e.g. SoundExchange), royalties for the public digital performance (e.g. webcast) of the Work, subject to the compulsory license created by 17 USC Section 114 of the US Copyright Act (or the equivalent in other jurisdictions).

The above rights may be exercised in all media and formats whether now known or hereafter devised. The above rights include the right to make such modifications as are technically necessary to exercise the rights in other media and formats, but otherwise You have no rights to make Derivative Works. All rights not expressly granted by Licensor are hereby reserved.

E.4 Restrictions

The license granted in Section E.3 above is expressly made subject to and limited by the following restrictions:

1. You may distribute, publicly display, publicly perform, or publicly digitally perform the Work only under the terms of this License, and You must include a copy of, or the Uniform Resource Identifier for, this License with every copy or phonorecord of the Work You distribute, publicly display, publicly perform, or publicly digitally perform. You may not offer or impose any terms on the Work that alter or restrict the terms of this License or the recipients' exercise

of the rights granted hereunder. You may not sublicense the Work. You must keep intact all notices that refer to this License and to the disclaimer of warranties. You may not distribute, publicly display, publicly perform, or publicly digitally perform the Work with any technological measures that control access or use of the Work in a manner inconsistent with the terms of this License Agreement. The above applies to the Work as incorporated in a Collective Work, but this does not require the Collective Work apart from the Work itself to be made subject to the terms of this License. If You create a Collective Work, upon notice from any Licensor You must, to the extent practicable, remove from the Collective Work any credit as required by clause 4(b), as requested.

2. If You distribute, publicly display, publicly perform, or publicly digitally perform the Work or Collective Works, You must keep intact all copyright notices for the Work and provide, reasonable to the medium or means You are utilizing: (i) the name of the Original Author (or pseudonym, if applicable) if supplied, and/or (ii) if the Original Author and/or Licensor designate another party or parties (e.g. a sponsor institute, publishing entity, journal) for attribution in Licensor's copyright notice, terms of service or by other reasonable means, the name of such party or parties; the title of the Work if supplied; and to the extent reasonably practicable, the Uniform Resource Identifier, if any, that Licensor specifies to be associated with the Work, unless such URI does not refer to the copyright notice or licensing information for the Work. Such credit may be implemented in any reasonable manner; provided, however, that in the case of a Collective Work, at a minimum such credit will appear where any other comparable authorship credit appears and in a manner at least as prominent as such other comparable authorship credit.

E.5 Representations, Warranties and Disclaimer

UNLESS OTHERWISE MUTUALLY AGREED TO BY THE PARTIES IN WRITING, LICENSOR OFFERS THE WORK AS-IS AND MAKES NO REPRESENTATIONS OR WARRANTIES OF ANY KIND CONCERNING THE MATERIALS, EXPRESS, IMPLIED, STATUTORY OR OTHERWISE, INCLUDING, WITHOUT LIMITATION, WARRANTIES OF TITLE, MERCHANTABILITY, FITNESS FOR A PARTICULAR PURPOSE, NONINFRINGEMENT, OR THE ABSENCE OF LATENT OR OTHER DEFECTS, ACCURACY, OR THE PRESENCE OF ABSENCE OF ERRORS, WHETHER OR NOT DISCOVERABLE. SOME

JURISDICTIONS DO NOT ALLOW THE EXCLUSION OF IMPLIED WARRANTIES, SO SUCH EXCLUSION MAY NOT APPLY TO YOU.

E.6 Limitation on Liability

EXCEPT TO THE EXTENT REQUIRED BY APPLICABLE LAW, IN NO EVENT WILL LICENSOR BE LIABLE TO YOU ON ANY LEGAL THEORY FOR ANY SPECIAL, INCIDENTAL, CONSEQUENTIAL, PUNITIVE OR EXEMPLARY DAMAGES ARISING OUT OF THIS LICENSE OR THE USE OF THE WORK, EVEN IF LICENSOR HAS BEEN ADVISED OF THE POSSIBILITY OF SUCH DAMAGES.

E.7 Termination

1. This License and the rights granted hereunder will terminate automatically upon any breach by You of the terms of this License. Individuals or entities who have received Collective Works from You under this License, however, will not have their licenses terminated provided such individuals or entities remain in full compliance with those licenses. Sections E.1, E.2, E.5, E.6, E.7, and E.8 will survive any termination of this License.
2. Subject to the above terms and conditions, the license granted here is perpetual (for the duration of the applicable copyright in the Work). Notwithstanding the above, Licensor reserves the right to release the Work under different license terms or to stop distributing the Work at any time; provided, however that any such election will not serve to withdraw this License (or any other license that has been, or is required to be, granted under the terms of this License), and this License will continue in full force and effect unless terminated as stated above.

E.8 Miscellaneous

1. Each time You distribute or publicly digitally perform the Work, the Licensor offers to the recipient a license to the Work on the same terms and conditions as the license granted to You under this License.

2. If any provision of this License is invalid or unenforceable under applicable law, it shall not affect the validity or enforceability of the remainder of the terms of this License, and without further action by the parties to this agreement, such provision shall be reformed to the minimum extent necessary to make such provision valid and enforceable.
3. No term or provision of this License shall be deemed waived and no breach consented to unless such waiver or consent shall be in writing and signed by the party to be charged with such waiver or consent.
4. This License constitutes the entire agreement between the parties with respect to the Work licensed here. There are no understandings, agreements or representations with respect to the Work not specified here. Licensor shall not be bound by any additional provisions that may appear in any communication from You. This License may not be modified without the mutual written agreement of the Licensor and You.

Bibliography

References

1. Booch, G., et al. 1998. *Unified Modeling Language User Guide*. Reading, MA: Addison-Wesley.
2. Gamma, E., et al. 1994. *Design Patterns*. Reading, MA: Addison-Wesley.
3. Grimes, R. 1998. *Professional DCOM Programming*. Chicago, IL: Wrox Press.
4. Henning, M., and S. Vinoski. 1999. *Advanced CORBA Programming with C++*. Reading, MA: Addison-Wesley.
5. Housley, R., and T. Polk. 2001. *Planning for PKI: Best Practices Guide for Deploying Public Key Infrastructure*. Hoboken, NJ: Wiley.
6. Institute of Electrical and Electronics Engineers. 1985. *IEEE 754-1985 Standard for Binary Floating-Point Arithmetic*. Piscataway, NJ: Institute of Electrical and Electronic Engineers.
7. Jain, P., et al. 1997. "Dynamically Configuring Communication Services with the Service Configurator Pattern." *C++ Report 9* (6).
<http://www.cs.wustl.edu/~schmidt/PDF/Svc-Conf.pdf>.
8. Kleiman, S., et al. 1995. *Programming With Threads*. Englewood, NJ: Prentice Hall.

9. Lakos, J. 1996. *Large-Scale C++ Software Design*. Reading, MA: Addison-Wesley.
10. McKusick, M. K., et al. 1996. *The Design and Implementation of the 4.4BSD Operating System*. Reading, MA: Addison-Wesley.
11. Microsoft. 2002. *.NET Infrastructure & Services*.
<http://www.microsoft.com/technet/treeview/default.asp?url=/technet/itsolutions/net/Default.asp>. Bellevue, WA: Microsoft.
12. Mitchell, J. G., et al. 1979. *Mesa Language Manual*. CSL-793. Palo Alto, CA: Xerox PARC.
13. Object Management Group. 2001. *Unified Modeling Language Specification*.
<http://www.omg.org/technology/documents/formal/uml.htm>. Framingham, MA: Object Management Group.
14. The Open Group. 1997. *DCE 1.1: Remote Procedure Call*. Technical Standard C706. <http://www.opengroup.org/publications/catalog/c706.htm>. Cambridge, MA: The Open Group.
15. Prescod, P. 2002. *Some Thoughts About SOAP Versus REST on Security*.
<http://www.prescod.net/rest/security.html>.
16. Red Hat, Inc. 2003. *The bzip2 and libbzip2 Home Page*.
<http://sources.redhat.com/bzip2>. Raleigh, NC: Red Hat, Inc.
17. Schmidt, D. C. et al. 2000. "Leader/Followers: A Design Pattern for Efficient Multi-Threaded Event Demultiplexing and Dispatching". In *Proceedings of the 7th Pattern Languages of Programs Conference*, WUCS-00-29, Seattle, WA: University of Washington. <http://www.cs.wustl.edu/~schmidt/PDF/lf.pdf>.
18. Sleepycat Software, Inc. 2003. *Berkeley DB Technical Articles*.
<http://www.sleepycat.com/company/technical.shtml>. Lincoln, MA: Sleepycat Software, Inc.
19. Snader, J. C. 2000. *Effective TCP/IP Programming*. Reading, MA: Addison-Wesley.
20. Stroustrup, B. 1997. *The C++ Programming Language*. Reading, MA: Addison-Wesley.
21. Sutter, H. 1999. *Exceptional C++: 47 Engineering Puzzles, Programming Problems, and Solutions*. Reading, MA: Addison-Wesley.
22. Sutter, H. 2002. "A Pragmatic Look at Exception Specifications." *C/C++ Users Journal* 20 (7): 59–64. <http://www.gotw.ca/publications/mill22.htm>.

23. Unicode Consortium, ed. 2000. *The Unicode Standard, Version 3.0*. Reading, MA: Addison-Wesley. <http://www.unicode.org/unicode/uni2book/u2.html>.
24. Viega, J., et al. 2002. *Network Security with OpenSSL*. Sebastopol, CA: O'Reilly.
25. Walsh, N., and L. Muellner. 1999. *DocBook: The Definitive Guide*. Sebastopol, CA: O'Reilly. <http://www.docbook.org>.
26. World Wide Web Consortium. 2002. *SOAP Version 1.2 Specification*. <http://www.w3.org/2000/xml/Group/#soap12>. Boston, MA: World Wide Web Consortium.
27. World Wide Web Consortium. 2002. *Web Services Activity*. <http://www.w3.org/2002/ws>. Boston, MA: World Wide Web Consortium.

